

Everything you want to know about home improvement inside!

Today's Observer features our Fall Home Improvement section, with the theme "Getting Energized."

The 24-page section is chock full of stories about ways to upgrade homes with an eye on conserving energy and cutting utility bills. Stories focus on the importance of updating furnaces and fireplaces, with natural gas costs expected to soar during this coming winter.

Several pages are brimming with "Hammer Time" contributions, readers' own stories and photographs about their "do-it-yourself" home repair projects. We solicited such entries several weeks ago in your Observer, and the response was excellent.

Because of space concerns, however, we were not able to include all of the stories and photographs. Whether or not your entry made the final product, thanks for participating.

THE WEEK AHEAD

TUESDAY

Hockey boosters: The Plymouth Canton Community Schools Hockey Booster Club meets at 7 p.m. at the Plymouth Cultural Center.

Township meets: The Plymouth Township board meets at 7 p.m. at township hall. Supervisor Steve Mann is expected to make his recommendation for the township's new fire chief.

WEDNESDAY

Money matters: The Plymouth Township board meets in a budget session that is open to the public and begins at 6 p.m.

INDEX

Apartments/E12	Malls/C6
Arts/C1	Movies/C4
Automotive/H4	New Homes/E1
Classified/E,G,H	Obituaries/A6
Classified	Real Estate/E1
Index/E5	Service Guide/H3
Crossword	Sports/B1
Puzzle/E7	Taste/D1
Jobs/G1	Travel/C8

Department adds firefighters



■ Everyone appears to be in agreement the Plymouth Community Fire Department needed more manpower, so that's exactly what it got when officials brought in three new firefighters.

BY KURT KUBAN
STAFF WRITER
kkuban@oe.hometown.net

The Plymouth Community Fire Department hired firefighter Matt Tuttle on Thursday. His hiring marked the third firefighter brought in by the department in the last month, bringing

the department's total to 24 full-time firefighters.

Patrick Conely, 31, of Saline, and Rick Abraham, 25, of Wayne, both began work with the department in late August. Tuttle, a 23-year-old Chelsea resident, should begin working within three weeks, according to PCFD Chief Larry Groth.

The addition of the three men is sorely needed, according to Jim Haar, the president of the Plymouth Community Firefighters Association. Haar and other union officials have criticized the department in recent months, saying it is understaffed and can't adequately deal with the number of calls in Plymouth and Plymouth Township.

"We absolutely see this as a positive move. We're happy to have them aboard. We definitely need them because the volume of calls continues to increase," Haar said.

Groth agrees the department needs more firefighters. He said last year

alone, the department received 3,200 calls. Of those, 2,000 were ambulance runs, and the rest were fire-related.

"We have been working to increase our staffing level. It's just not going to happen overnight. But we will continue to move in that direction, because the workload of this community keeps us busy," he said.

The addition of the three men gives the department 18 firefighters/paramedics, three lieutenants, and three captains. Conely, Abraham and Tuttle are licensed.

Please see **FIREFIGHTERS, A2**

Fall festivities



STAFF PHOTOS BY PAUL HURSCHEMANN



Festival fun: Catherine Bank of Northville, 7, left, watches as her sister Caitlin, 4, makes Spin Art with Madison Macek of Plymouth, 7, at the New Morning School booth in Kellogg Park on the first day of Fall Festival Friday. The school will offer face painting, temporary tattoos, sand art and more through tonight. (Left) Amanda Brushaber of Canton, 4, enjoys some cotton candy as her brother Sam, 2, and friend Miranda St Amour of Livonia, 4, watch some older folks play a game on the midway along Main Street.

Historic designation could spur vets park

BY TONY BRUSCATO
STAFF WRITER
tbruscato@oe.hometown.net

It's been 10 years in the making, but members of the Plymouth Community Veterans Memorial Park committee believe the time has finally come to initiate plans for a Veterans Memorial Park on city-owned property in front of Central Middle School.

"There's been a lot of foot dragging since 1991, but the time has come to do it," said Bob Zaetta, chairman of the committee. "You're going to see things happen. We're prepared to move as quickly as possible."

■ **'The designation will also help protect the property to keep it a Veterans Memorial Park.'**

—Bob Zaetta
—Committee chairman

a historic district will provide the impetus for much needed funding.

"We went to the historic commission for the main purpose of funding because there could be grants available," said Zaetta. "The designation will also help protect the property to keep it a Veterans Memorial Park."

Getting the project started has been the real challenge for veterans who want to see a Veterans Memorial Park to honor the men and women from Plymouth who fought for their country from the Civil War forward. Plymouth Mayor Dave McDonald unveiled a \$300,000 fund-raising effort Nov. 11, in which he announced a 501(c)(3) non-profit foundation would be set up to collect money from businesses, corpo-

Please see **PARK, A3**

Here's your CHANCE TO WIN a furniture shopping spree

The Observer & Eccentric Newspapers and 12 area merchants are teaming up to send 12 lucky winners on a home furnishings shopping spree.

It's all part of Fabulous Furniture 2001 to be featured in our At Home section on Thursday, Oct. 4, 11 and 18.

Just think: You could be one of 12 lucky winners who will receive a \$1,000 gift certificate to shop at Newton Furniture (Bloomfield Hills, Livonia, Novi and Sterling Heights locations), Ethan Allen (Ann Arbor, Auburn Hills, Birmingham, Livonia and Novi locations), Classic Interiors (Livonia), Franks Furniture (Wayne), Laurel Furniture (downtown Plymouth), Walker/Buzenberg (downtown Plymouth), In-Style Furniture (West Bloomfield), Sherwood Studios (West Bloomfield), Dalley Carpet (locations in Livonia and Canton), Eclipse Window Treat (Redford Township), McLaughlin's (locations in Novi and Southgate) and Baker Furniture (downtown Birmingham).

Fun starts Oct. 4

Winning is easy. Each participating merchant will have official Fabulous Furniture entry forms available beginning Oct. 4. You may enter one time at each store. So you'll want to visit each store (several merchants have multiple locations) and increase your chances of winning.

You must be at least 18 years old to enter. All entries have an equal chance of being drawn. Deadline to enter is 5 p.m. Thursday, Oct. 25.

Look for the entry form in your Thursday and Sunday Observer or Eccentric edition and in participating merchants' stores beginning Thursday, Oct. 4.

Don't miss the Oct. 4 At Home section which takes a look at dining rooms and kitchens. Look for tips on how to make your dining room a center for family gatherings. Read about what's new in kitchen flooring, cabinets and countertops. Read about how to unravel the mystery of furniture styles.

On Thursday, Oct. 11, At Home will feature living rooms and great rooms.

Find out how to make your living room reflect comfort not formality. Read about the latest choices in entertainment centers and how to use art as furniture.

To complete our series, the Observer will present bedrooms and bathrooms. Discover how to turn your bedroom into a retreat and what mattress to buy for a good night's sleep. Stories on new furniture styles, windows, oriental rugs, clocks, lighting and appliances are all part of the package.

A special "Designer's Corner" will offer decorating tips each week. When you visit participating merchants be sure to look for the Fabulous Furniture in-store displays and entry forms. Contest details can also be found in your Observer every Thursday and Sunday. Or visit a nearby Observer office to pick up an entry form or copy of the newspaper for contest details.

Don't miss this chance to spruce up your home and read about the latest in furniture styles and decorating tips in Fabulous Furniture 2001.



DENTAL RECEPTIONIST
Dental exp 32-34 hrs/wk
Computer skills Top salary
Benefits Farmington Hills

"We found someone thanks to your ad."
R.B.
Farmington Hills

HOMETOWN CLASSIFIEDS WORK!
1-800-579-SELL



6 53174 10008 5

HomeTown News... it's all about you!
Plymouth Observer

HOW TO REACH US

Susan Rosiek, Publisher
 (734) 953-2100
 srosiek@oe homecomm net



Hugh Gallagher, Managing Editor
 (734) 953-2149
 hgallagher@oe homecomm net



Brad Kadrach, Editor
 (734) 459-2700
 bkadrach@oe homecomm net

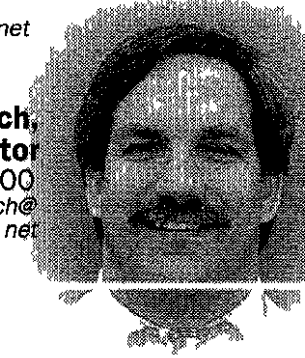

Tony Bruscato, Reporter
 (734) 459-2700
 tbruscato@oe homecomm net

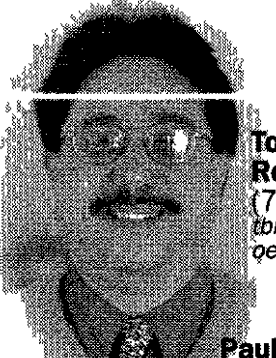

Paul Hurschmann, Photographer
 (734) 459-2700
 phurschmann@oe homecomm net



C.J. Risak, Sports Editor
 (734) 953-2108
 crisak@oe homecomm net



Kurt Kuban, Reporter
 (734) 459-2700
 kkuban@oe homecomm net



Greg Phillips, Home Delivery Manager
 (734) 953 2244
 custserv@oe homecomm net



Lisa Walker, Ad Representative
 (734) 953 2168
 lwalker@oe homecomm net



Brenda Urick, Receptionist
 (734) 416 9400



HOW TO REACH US

- Circulation Nightline.....734-591-0500
- Classified Advertising.....800-579-7355
- Display Advertising.....734-591-2300
- Home Delivery.....734-591-0500
- Newsroom FAX.....734-459-4224
- Newsroom.....734-459-2700
- O&E Online* www.observer-eccentric.com248-901-4716
- Photo Reprints**.....734-591-0500
- Reader Comment Line734-953-2040
- Sports Nightline734-953-2104

* OnLine — www.observer-eccentric.com — can be accessed with just about any communications software PC or Macintosh. You are able to send and receive unlimited e-mail access all features of the Internet, read electronic editions of The Plymouth Observer and other Observer & Eccentric Newspapers and chat with users across town or across the country.

**Photo orders must be for pictures that have been taken by our staff photographers. Please provide publication date, page number and description of the picture which must have been published within the past six months. Prints are \$20 for the first print \$7.50 for each additional print. Payment is in advance (check or credit card).

HomeTown News... it's all about you!
Plymouth Observer

A HomeTown Communications Network™ publication
 794 South Main, Plymouth, MI 48170
 (Between Ann Arbor Rd and Ann Arbor Tr, across from March Tire)

SUBSCRIPTION RATES

CARRIER DELIVERY		MAIL DELIVERY	
Six months	\$25.50	One year	\$62.60
One year	\$51.00	One year (Sr Citizen)	\$51.60
One year (Sr Citizen)	\$41.60	One year (out of State)	\$97.60
Newsstand	75¢ per copy		

All advertising published in the Plymouth Observer is subject to the conditions stated in the applicable rate card copies of which are available from the advertising department. The Plymouth Observer 794 South Main Plymouth MI 48170 (734) 459-2700. The Plymouth Observer reserves the right not to accept an advertiser's order. Observer & Eccentric ad takers have no authority to bind this newspaper and only publication of an advertisement shall constitute that acceptance of the advertised order.



Readers get a chance to tell us what they think!

Ever wanted to let the newspaper know what you think of the job they do? Ever see a paper and think, "I could do better?" Now's your chance. The Plymouth Observer is seeking volunteers for its Citizens' Advisory Panel, a focus group designed to elicit ideas and discuss the way we get information to our readers. The group will meet periodically over the next year or so to gather information and opinions and to chart a course for the direction of the newspaper. If you're interested, call editor Brad Kadrach, (734) 459-2700, or email him at bkadrach@oe.homecomm.net. The cookies are on the paper!

Law enforcement ready for Torch Run

Law enforcement officers will be carrying the torch for Special Olympics Friday. The annual Law Enforcement Torch Run for Special Olympics started happening in the state Saturday, and comes to Plymouth at the Western Wayne Correctional facility from 10 to 11:30 a.m. Friday. The idea is to raise awareness and funds for Special Olympics Michigan. "Funds support year-round sports training and competition for children and adults with mental retardation," said Marcy Lindberg of Special Olympics Michigan. Friday's run starts at the Western Wayne Correctional Facility on Five Mile Road. Runners head to Our Lady of Providence on Beck Road, where they'll mingle with athletes. Runners then continue up to Six Mile and back to Scott Correctional Facility on Five Mile Road. According to Lindberg, Michigan has the 12th largest torch run in the world. Nine major law enforcement agencies organize and participate in Torch Run activities, with 1,700 officers involved across the state. In 2000, the Michigan Law Enforcement Torch Run raised \$433,000 and held activities in approximately 90 communities, including Plymouth. Anyone can make a donation to the Torch Run by calling 1-866-TORCHRUN (867-2478).

Firefighters *from page A1*

paramedics and certified firefighters, and will be required to perform both duties. "They will be doing both jobs, and whatever they are required to do," Groth said. Before the hirings, the department only had 21 firefighters, meaning only two were on duty at each of the three stations during regular shifts. Now, two of the stations will have three firefighters on each shift while Station 2 near the Lake Pointe subdivision will have two working during regular shifts. According to Groth, the ultimate goal is to have 10 firefighters working per shift. Plans are to hire three more firefighters in January 2002 and three more in 2004. He said Plymouth Township Supervisor Steve Mann has told him to start the process of hiring the first three in the coming months. "The supervisor has told me not to wait until January to get the ball rolling. He wants me to have three candidates ready to start work Jan. 1. So I will start the screening process in November to meet that goal," he said. Conely, Abraham and Tuttle will all start on the lowest step of the pay scale, which is an annual salary of \$28,726. However, that may change once the township and union come to terms on a new contract. The union has been working without a contract since March 2000. The union chose to use a mediator to try to solve the contract impasse. Both sides met with a mediator Aug. 15, and another session is expected to take place at the end of the month. Groth and Haar said some progress was made at the August meeting. "We made good progress and feel we're close to agreeing to a contract," Haar said. Both sides said they want to avoid going to arbitration. While mediation is non-binding, an arbitrator's decision would be. "The goal would be to avoid arbitration, because it comes at a great cost to the township. I don't think either side wants to see that," Groth said.

PLYMOUTH PIPELINE

Parent night

"Keys to Success" will be the hot topic for the Plymouth-Canton schools' Junior-Senior Parent Night from 7 to 9 p.m. Wednesday, Sept. 12, in the auditorium at Plymouth Salem High School. The event is presented by the PCEF Counseling Department. Keynote speakers include Phil Gardner from Michigan State University, who will talk about speeding into the 21st century, and Judy Tatum of Eastern Michigan University, who will discuss the college selection process. Immediately following the speakers, parents will have the chance to meet with the counselor to review post-high school planning.

Recreation registration

The City of Plymouth is now taking registrations for its fall aerobics and yoga classes. Flexball and core body conditioning will be offered Monday mornings and Wednesday evenings beginning Sept. 17. Yoga will be offered Monday and Wednesday evenings and Friday mornings beginning Monday. For more information, call the recreation division, (734) 455-6620, or check out the programs on the Web at www.ci.plymouth.mi.us.

Candidates speak

Candidates for the Plymouth City Commission have been invited to speak and answer questions at the Plymouth Republic Club's meeting Sept. 13. The meeting takes place at the Plymouth District Library at 7 p.m. There is no cost for the event. Regular meetings of the Plymouth Republican Club take place the second Thursday of each month at the library. For more information, call (734) 414-0709.

Theology on tap

An increasingly popular activity among adult Christians comes to The Box Bar four times this fall. Theology on Tap gives single and married adults an opportunity to meet and share faith and spiritual experiences in a relaxed social setting. The program, sponsored by Canton's St. John Neumann Catholic Church, takes place each Tuesday evening between Sept. 11 and Oct. 2, starting at 7 p.m. "People can have a drink and engage in meaningful conversations about faith in a less formal and more comfortable atmosphere," said Tom West, coordinator of St. John Neumann's Youth and Young Adult groups. "We invite anyone who's interested to bring a friend with them." A different subject will be the focus of each week's discussion. Conversations will center on personal identity as it relates to each individual, family, friends, God and the world, according to West.

The Box Bar is located at 777 W. Ann Arbor Trail in Plymouth. Participants must be at least 18 years of age. For more information or to reserve a spot, call St. John Neumann at (734) 455-5910, or e-mail West at tommyboy629@hotmail.com.

Doctor donations

Dr. Richard Chase and Dr. Richard Sowerby of the Chase Chiropractic Office in Plymouth are donating a day of service to the Plymouth area community. Care provided Saturday, Sept. 15, will be done in exchange for canned or non-perishable items only. All food collected will be turned over to the Salvation Army in Plymouth. This care includes all services for existing patients as well as new patients. "The purpose of this special day," Dr. Chase said, "is to appreciate our patients and acknowledge and support our community." To schedule an appointment or to just donate food, call (734) 455-3593.

Symphony auditions

Evola Music hosts auditions for the Plymouth Symphony Orchestra from 4-8 p.m. Monday, Sept. 10, at 7170 N. Haggerty Road in Canton. The symphony is seeking experienced players with advanced musical skills for fall auditions for the 56th concert season. Posted positions for per-service wage include principal viola, fourth horn, tuba and section string musicians. Substitute musicians are needed for wind, brass and percussion section positions. Other openings may be posted as necessary. Audition selections will be taken from standard orchestra repertoire. Non-standard selections will be supplied. Auditions are by appointment only. Full orchestra rehearsals begin Monday, Oct. 1. For more information, to schedule an audition appointment or if you're interested but not available that day, call personnel manager William Hulsker, (313) 640-1773, or e-mail to plymouth-symphony@aol.com.

BUY THIS BOX.

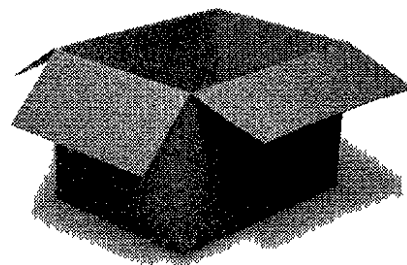

GET THIS ONE FREE.

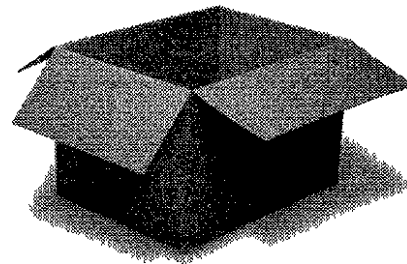

Come to Storage USA for all your moving and packing supplies. And for a limited time when you buy a box from Storage USA we'll throw in another one just like it - free. Limit 3 per customer. Offer ends soon. So clip this coupon today and take it to the Storage USA location nearest you. Or call toll free 1-800-STOR-USA for more information.

STORAGE USA

Offer expires December 31, 2001. Excludes Value Packs and any other promotional offers. ©2001 Storage USA.

PARKWAY PROFESSIONAL GROOMING
 We offer:
 All Breed Dog Grooming
 30 Years experience in the Pet Profession
 Specializing in:
 Bichon Frise
 Shih-Tzu
 Golden Retrievers
 Bichon Frise cards figurines cups everything for the Bichon lover in your family
 NEW CUSTOMER SAVINGS
\$5.00 OFF
 On All Complete Grooms
 Not valid with any other offer.
734-453-9488
 418 N. Main • Plymouth
 Between Starkweather & Lilley
 M-TU-TH-F-SAT 9 AM - 5 PM
 We are your pet care specialists!
 FREE Bandanas w/grooming

ADVANCEMENTS IN FOOT CARE
 - presented by -
Canton Foot Specialists
 Dr. Steven Watson PREVENT ATHLETE'S FOOT Dr. Michael LeHondt
 Anyone can suffer from athlete's foot. It's a fungal infection that thrives in a warm, moist and dark environment. Shoes present an excellent environment for fungal infections to grow. The best prevention is to create a shoe climate least suitable for their growth.
 • Choose a shoe made of a natural material that allows the foot to breathe
 • Apply absorbing cornstarch to your shoes before and after wearing them
 • Don't wear the same shoes on consecutive days
 • Clean your feet thoroughly at least twice a day
 • Change your socks at least twice a day
 If you are prone to athlete's foot or other fungal infections, see your podiatrist. Fungus can cause severe nail infections, but new medications are available by prescription for this condition.
 We specialize in non-surgical relief of heel pain.
 **Early morning, evening, and Saturday appointments available
Canton Foot Specialists
 SAINT JOSEPH MERCY HEALTH SYSTEM
 A Member of Mercy Health Services
 St. Joseph Mercy Canton Health Center
 1600 S. Canton Center Rd. S. 350
 Canton, MI 48188
 PH. 734-981-7800 OR CHECK US OUT AT www.csdrrwatson.com

SHOWROOM Of ELEGANCE

Fine Jewelry

EVERYDAY
LOW PRICES!

- Huge selection of loose, certified diamonds and mountings
- Expert jewelry repair service

Your Source for
Diamond Bracelets
Over 200 Diamond
Bracelets IN
STOCK

9 ct. T.W.
14K Y/G
\$10,950⁰⁰

4 ct. T.W.
14K Y/G
\$2595⁰⁰

3 ct. T.W.
14K Y/G
\$1350⁰⁰

Also available in:
4 ct. T.W. . . **\$2195⁰⁰**
5 ct. T.W. **\$3295⁰⁰**

2 ct. T.W.
14K Y/G
\$2195⁰⁰

14K Bangle
32 ct. T.W. **\$750⁰⁰**
50 ct. T.W. ... **\$1195⁰⁰**
69 ct. T.W. ... **\$2495⁰⁰**
96 ct. T.W. ... **\$3795⁰⁰**

1.00 ct. T.W. Princess
Cut
Diamond Bangle
\$1540⁰⁰

6018 Canton Center Rd.
(N. of Ford Rd.)
Canton
M-T-W-F-S
10-6
Thurs. 10-8
734-207-1906

Employees evacuate toy maker

BY KURT KUBAN
STAFF WRITER
kkuban@oe.homecomm.net

Employees at a Plymouth Township toy factory and several surrounding businesses were evacuated Wednesday evening after several employees complained of becoming sick from fumes.

Shortly after 6 p.m., a plant manager at Poof Toys Products, located at 45400 Helm, made the decision to clear the building of more than 20 employees after several thought they smelled gas. The manager then called the Plymouth Community Fire Department.

When fire officials arrived, they didn't find any evidence of gas inside the factory, so they called in the Western Wayne County HASMAT team, a hazardous materials unit, to determine if there were any chemical leaks.

In addition to evacuating eight surrounding businesses in the industrial park near Sheldon and Five Mile roads, fire officials kept Poof employees on the scene for several hours to make sure none of them suffered toxic poisoning, according to fire chief Larry Groth.

"After determining there wasn't a gas leak, we decided to call in the HAZMAT team. We held the employees there for about three hours, until the team could determine if there was a problem with hazardous chemicals. We didn't want them to go home and get sick later. The team didn't find anything, and we let the employees go home," Groth said.

The company, which has been at its current location since 1990, manufactures sponge-like footballs, basketballs, and soccer balls similar to Nerf balls.

According to Groth, six Poof employees experienced vomiting, headaches, and sore throats — all symptoms consistent with poisoning from polyurethane. The company uses a polyurethane system, in which several polymers are mixed in a mold. When the mold is heated, the chemicals mix and expand into the foam toys.

Groth said fire officials initially thought some residue from the process may have leaked onto a furnace, causing the vapors that employees smelled. None of the six employees required medi-

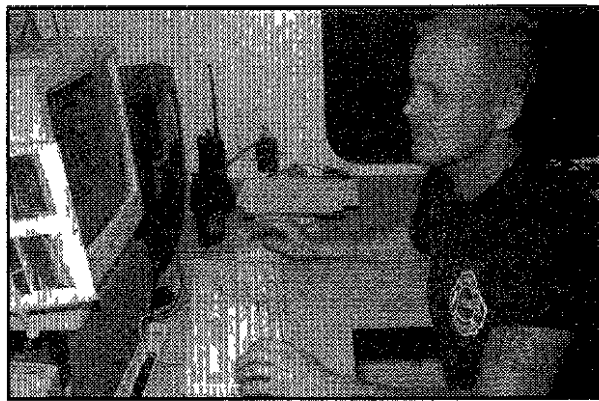

PHOTO BY RONALD FOSKEY

Checking it out: Livonia firefighter Tom Clark studies chemical readings on the computer as the hazardous materials team ponders what happened at Poof Products Wednesday.

cal treatment, he said.

Poof president and CEO Ray Dallavecchia said inspectors were at the plant Thursday and didn't find any problems, around the furnace or anywhere else. He called the entire incident a "non-event," and said the six employees probably just thought they were sick.

"I think it was a case where someone thought they smelled gas, and as the word spread, several people had psychosomatic reactions, where they convinced themselves they were sick. There was no gas leak or chemical spill," he said.

Although Dallavecchia would rather have seen his manager call the gas company than the fire department, he said the manager made the right decision to evacuate the building.

"I commend the manager for doing what he thought was right. He thought the employees were in danger, and I don't want any of my workers to get hurt on the job," he said.

Dallavecchia said everyone was back to work on Thursday and working hard to manufacture enough toys to meet the coming Christmas demand.



Playing Plymouth: The Concord Trio — pianist Jeanne Kierman, cellist Norman Fischer and violinist Andrew Jennings — plays the Plymouth Community Arts Council Sept. 21 at 8 p.m. Fischer is the son of long-time Plymouth residents Beth Fischer and the late Gerald Fischer.

Classical trio plays Plymouth arts council

The Concord Trio, an internationally known, highly acclaimed group of classical musicians, performs at the Plymouth Community Arts Council at 8 p.m. Friday, Sept. 21.

And the concert will have a decidedly Plymouth flavor.

Trio member and cellist Norman Fischer is the son of long-time Plymouth residents Beth Fischer and the late Gerald Fischer. He, along with violinist Andrew Jennings and pianist Jeanne Kierman, have made many recordings performed around the world and received numerous awards, including an Emmy and several Grammy nominations. All three members hold university music appointments in addition to their performance schedule.

According to PCAC publicist

Nancy Pilon, the Concord Trio is "known for its wide ranging interpretations of the trio repertoire. Their joyful and exuberant concerts have been exciting audiences and critics for nearly 30 years."

The concert is the first in a series of three Friday night presentations at the PCAC. The Broadway hit Love Letters will feature former Plymouth Canton drama teacher Gloria Logan and Dennis Cockrum Oct. 19 and The Raisin Pickers are back Nov. 16.

Tickets for any performance can be purchased for \$25 each at the PCAC, 774 N. Sheldon in person from 9 a.m. to noon weekdays, or can be charged over the phone. For more information, call (734) 416-4278.

POLICE BLOTTER

Suspicious death

Plymouth Township police officials are investigating the death of a township resident who died Aug. 31 at his home on the 46000 block of Danbridge.

Police officials didn't release the 46-year-old man's name.

According to the police report, the man's 56-year-old male roommate made a hysterical 911 call around 8 p.m., telling a police dispatcher the man was lying in a pool of blood on a bedroom floor.

When police officers arrived they found the lifeless man in a second-floor bedroom. The cause of death was not immediately

known.

Officers called the Wayne County Medical Examiner, and secured the house from the public. The medical examiner performed an autopsy on the body last week to determine the cause of death. The results are pending.

The case is still under investigation.

Clubs stolen

Someone broke into Carl's Golf Shop in the early morning hours Sept. 2 and stole a rack full of Titleist golf clubs worth more than \$6,000.

According to the police report

someone entered the store by throwing a rock through a glass door. An employee called police when he arrived at work around 5:30 a.m. and noticed the shattered door.

Police officers investigated the store, located on the 44000 block of Five Mile, and found only the rack of clubs missing. No cash registers were tampered with, and nothing else appeared damaged. They checked for signs of footprints in the nearby wet grass but found none.

The store's alarm never went off according to the report. The glass door was valued at close to \$450.

Get the best coverage of YOUR hometown every Thursday and Sunday, only in the Plymouth Observer

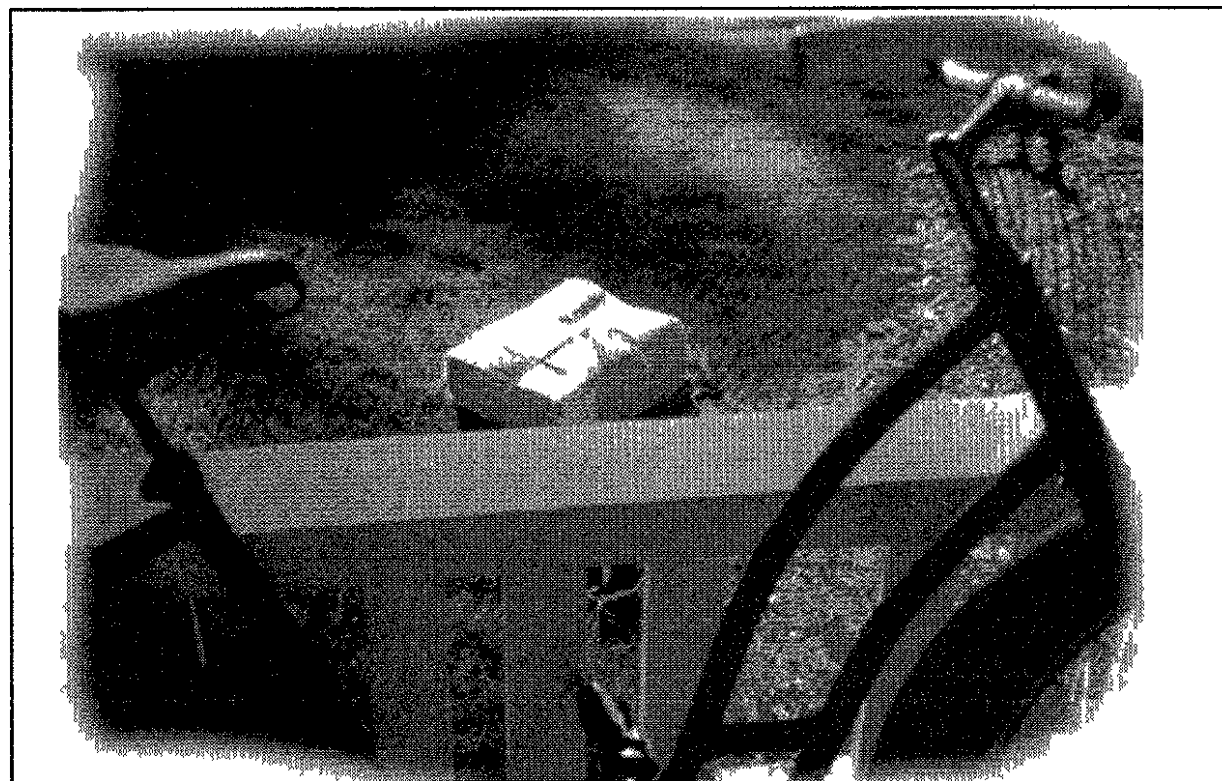

Your Sunday mornings and Thursday afternoons could be worth more than they are right now.

How about turning some spare time into spendable cash? It only takes a few hours twice each week to deliver your hometown Observer or Eccentric newspaper and throughout the year you'll have a lot of chances to win—and earn—some really great prizes.

We're looking for sons and daughters, moms and dads, and even grandparents who would like to join our great carrier team. (You can't be younger than 10 or older than dirt.)

Just call one of the numbers here and we'll get things rolling:

WAYNE COUNTY: 734-591-0500
OAKLAND COUNTY: 248-901-4716

THE
Observer & Eccentric
NEWSPAPERS

It's all about you!

Part of HomeTown Communities Network

Church retreat designed to help women relate to God with prayer

Christ Our Savior Lutheran Church in Livonia is inviting women to a special retreat called "Relating to God Through Prayer," Oct. 12-13 at the Laurel Park Marriott in Livonia. The registration deadline is Sept. 14.

Sharon Zehnder, an experienced retreat and conference speaker from Omaha, Neb., will be the featured speaker. The event begins 6 p.m. Friday, Oct. 12, and is scheduled to conclude around 4 p.m. Saturday.

The retreat fee includes your hotel room, three meals, workshops and other activities. Zehnder will be conducting the two-day workshop with her own prayer partner. For information please contact Lisa Bartoszek (734) 427-1837 or Christ Our Savior (734) 522-6830.

Katy's Bears & Hares

COLLECTIBLES

Steff • Hermann • Ganz • Knickerbocker
Artist • Mini's • Boyd • Muffy

SUNDAYS 8 A.M.-3 P.M.
at Royal Oak Flea Market
11 Mile Rd. between I-75 & Main St

Gift Certificates Available

End of Summer Special

\$35⁰⁰ Pedicure & Manicure

Select Shampoos and Conditioners
Now on Sale
Now at Headstart The Nail Lady from Mill St

HEADSTART HAIRSTYLING

412 N. Main Street • Plymouth • 734-459-3330
Hours • Mon 10-4 Wed 10-6 • Tues, Thurs & Fri 10-8 • Sat 10-4

County announces \$17 million in federal road money

BY TIM SMITH
STAFF WRITER
tsmith@oe homecomm.net

Christmas came early for Wayne County motorists who are tired of traversing bumpy stretches of Beech Daly, Sheldon and Five Mile among other area roads.

But the present - \$17 million in federal money for road improvement projects in the county - can't be "opened" until 2003.

A number of Observerland roads made the cut for the 2003 Federal Aid Road Projects program announced Wednesday by Wayne County Executive Ed McNamara.

For example, Beech Daly between Joy and Plymouth is earmarked to receive more than \$760,000 for work. Another \$1 million will go toward fixing up Merriman between Warren Road and Ann Arbor Trail. About \$640,000 will target a stretch of Seven Mile, between Haggerty

2003 FEDERAL AID ROAD PROJECTS (Federal share is 80 percent of amount shown)	
COUNTY ROADS	
■ Sheldon (Joy to Ann Arbor Trail)	\$1,189,868
■ Beech Daly (Joy to Plymouth roads)	763,647
■ Merriman (Warren Road to Ann Arbor Trail)	1,043,587
■ Seven Mile (E of Haggerty to Blue Skies)	639,453
■ Five Mile (Levan to Farmington roads)	1,224,657
■ Middlebelt (Van Born to Michigan Ave)	1,191,965
COUNTY PRIORITY INTERSECTIONS	
■ Warren at Inkster roads	158,840
FUNDING TO CITY PRIORITY PROJECTS	
■ Stark (Hines Drive to Plymouth Road)	227,901

(For more information, go to www.waynecounty.com/wayneroads)

and Newburgh. Two projects will each receive approximately \$1.2 million. Five Mile, from Levan to Farmington roads, Sheldon Road between Joy Road-Ann Arbor Trail.

"The roads we will fix with these federal dollars are among the most heavily traveled on the county system," said McNamara.

"These are the arteries the federal government considers the most critical to moving the people, goods and services that keep the economy healthy."

The federally aided roadwork won't start until the 2003 construction season. One more step remains for the 23 projects targeted for chunks of money - the

list requires final approval from the Southeastern Michigan Council of Governments as well as inclusion in the regional Transportation Improvement Plan.

Not a problem

According to Wayne County spokesman John Roach, SEMCOG's approval should be little more than a formality.

"There's really nothing too controversial on it so it should not be a problem," Roach said. "The key thing for these projects to become reality is we have to make sure the (architectural and engineering) design work gets done" to show good faith that the federal dollars won't go to waste.

Roach added that of the \$17 million plan, nearly \$4 million would be channeled toward road improvement projects identified by cities. One such project is in Livonia, on Stark Road from Hines Drive to Plymouth Road.

The list was unanimously

approved Wednesday by representatives from all 43 communities in Wayne County, during the county's annual federal aid meeting.

Most of the projects on the list will be resurfacing jobs, where 3-to-4 inches of asphalt will be laid over roadways "for completely new riding surfaces," Roach said. Roads will be extensively repaired prior to asphaltting, however.

Projects making the list were selected based on an annual survey of the county's road surface condition. Wayne County roads rated in the worst condition go to the top of the list for money from the county's share of federal and state gas tax revenues.

"We have seen significant improvement in the overall condition of our roads over the past several years," said Cameron Priebe, Wayne County's director of public services. "And the efficient use of our federal aid dol-

lars is a big reason."

Although the sight of orange cones is never a pleasant one, Roach said Wayne County residents should take comfort in knowing that the condition of area roads improves with each passing federal road repairs program.

"Every year we're seeing fewer poor roads and more roads in good condition," Roach said. "Every year we go through this process gets us closer and closer to eliminating all of the poor roads."

Calling the list "a living document" was Priebe.

"It is possible that we could obtain more federal funds, or that some of these projects could encounter obstacles that take them from the list for now," Priebe said. "To prepare for either scenario, we have a list of alternate projects the committee approved which can fill the gap."

Schoolcraft College offers Sunday Health Club memberships

You have more than a month of Sundays - in fact, you have 26 Sundays - to get in shape by joining Schoolcraft College's Sunday Health Club. Members can work out every Sunday afternoon of the fall and winter sessions. The fall session continues from Sept. 16 through Dec. 16 and the winter session begins

Jan. 6 and continues through March 31.

Membership fees are \$35 for individuals and \$74 for families for one session or \$60 for individuals and \$132 for families for both fall and winter sessions.

Each Sunday 1-5 p.m. members have access to two gyms for basketball and volleyball, six

handball, paddleball and racquetball courts, wallyball courts, weightlifting machines, treadmills, exercise bikes, and other aerobic equipment in the fitness room, the swimming pool with

two one-meter and one three-meter diving boards, and saunas in both the men and women's locker rooms.

The activity is at the level and intensity you set. Members

must furnish their own locks and towels, and children under age 16 must be accompanied by an adult or guardian. For additional information or to receive a registration form, call 734-462-

4413. Schoolcraft College is located at 18600 Haggerty Road, between Six and Seven Mile roads, just west of I-275.

Best Value Travel and Tours, Inc. and **Funjet Vacations**

Invite you to attend the **HONEYMOON OPEN HOUSE**
THURSDAY, SEPTEMBER 20, 2001 • 6:00 P.M.

Featuring *Sandals Resorts* and other romantic destinations!

Exclusive discounts up to \$350.00 per couple

RSVP 248-476-2020
20307 Middlebelt Road
between 7 and 8 Mile Road
Livonia, Michigan 48152

Res. c. ons app y M n num 7 n ght a. and hotel vacat on equ red. Va d n Funjet Vacat ons on y book ngs 45 days o. o e n advance. Discounts may va y by date o. eve des nat on, oom category, e c.

DANCE!

- Ballet
- Jazz
- Competition
- Pointe
- Pom Pon
- Musical Theater
- Tap
- Tumbling
- Mother-Daughter

REGISTER SEPT. 10th • 6-8 p.m.
LOW TUITION • NEW INSTRUCTORS WELCOME

\$10.00 OFF
1st Month Only
New Students
Valid 9-10-01

Register for one class, get **1 CLASS FREE**
Special Offers • Cannot be Combined
Valid 9-10-01

STUDIO K 9002 Middlebelt (1 blk N of Joy)
734-513-7125

Laser Hair Removal

A Craig Cattell MD and Associates offer the latest advances in treatments and cutting edge laser technology. Let us put 20 years of experience in dermatology to work for you to ensure your complete satisfaction.

- SKIN DISEASES
- SKIN CANCER
- ACNE
- MOHS SURGERY
- PSORIASIS
- SCLEROTHERAPY
- BOTOX
- INJECTIONS
- LASER SURGERY
- COLLAGEN IMPLANT
- SPIDER VEIN TREATMENT
- ACID PEELS
- WRINKLES
- AGING SKIN

734-455-6881
990 W. Ann Arbor Trail • Plymouth
734-996-8757
706 W. Huron • Ann Arbor
www.annarbordermatology.net

FREE Laser Consultation

Picture Perfect!

SAVE 40%

On A Sporty Blousont Natural **Mink Jacket**
Starting At **\$2,520**
Through Saturday Only!

In-Store Financing
No Finance Charges
Until December

Dittrich
Since 1893
Know Thy Furrier

Monday - Saturday 10 a.m. - 6 p.m.
Bloomfield Hills Thursday til 8:30 p.m.

Detroit (313) 873 8300
7373 Third Ave

Bloomfield Hills • (248) 642 3000
39515 Woodward Ave

Every Payment On Time www.dittrichfurs.com

YOUR GIFT FROM LANCÔME



FINAL WEEK! PARIS GETAWAYS

Get your free gift with any 21.50 or more Lancôme purchase. Choose your colour collection: Romantics or Sophisticates featuring:

- Two (full size) LipColours
- Compact of Colour Ombre Couture Multi-Effect EyeColour Duo and Blush Subtil Delicate Oil-Free Powder Blush

Plus:

- Definicils High Definition Mascara in Black
- Bi-Facil Double-Action Eye Makeup Remover
- Re-Surface Retinol Concentrate Wrinkle Corrector
- Lancôme Signature Cosmetic Case

IN COSMETICS ONE GIFT PER CUSTOMER PLEASE WHILE SUPPLIES LAST

LANCÔME INTRODUCES AMPLICILS PANORAMIC VOLUME MASCARA

Amplifies Curis Separates Lancôme, the world's mascara leader, gives lashes panoramic volume. The exclusive Ampliflex™ formula and patented brush build, curl and separate lashes with a fan-like sweep of vitamin-enriched fullness. No clumping. RESULT: Immensely thick, intensely glamorous lashes. In black, brown or deep brown, 19.50 IN COSMETICS



FREE COSMETIC MAKEOVERS Keep up on the latest skin care and color trends plus the latest products for men

P·A·R·I·S·I·A·N YOU'RE SOMEBODY SPECIAL

CALL 800-424-8185 TO ORDER ANYTIME. STORE HOURS: Laurel Park Place (953 7500) open Sun 12-6 Mon-Sat 10-9
FOR INFORMATION call 953-7500 CHARGE IT: Parisian Credit Card MasterCard Visa, the American Express® Card or Discover®
LOCATED AT LAUREL PARK PLACE IN LIVONIA, CORNER OF NEWBURGH ROAD AND SIX MILE ROAD (TAKE THE SIX MILE ROAD EXIT OFF INTERSTATE 275).

PLYMOUTH DISTRICT LIBRARY'S
POPULAR PICKS



Every week the Plymouth District Library staff provides the Observer with their list of "Best Sellers" based on the number of requests for titles by library patrons. The books are available by placing a request with the library, 433-0750.

FICTION

- 1) *Valhalla Rising*, Clive Cussler
- 2) *Suzanne's Diary For Nicholas*, James Patterson
- 3) *Hemlock Bay*, Catherine Couiter
- 4) *Cane River*, Lalita Tademy
- 5) *Smoke Jumper*, Nicholas Evans

NONFICTION

- 1) *Wild Blue*, Stephen Ambrose
- 2) *John Adams*, David McCullough
- 3) *Ghost Soldiers*, Hampton Sides
- 4) *The Map that Changed the World*, Simon Winchester
- 5) *In Harm's Way*, Doug Stanton

PARENT'S CHOICE

CHILDREN'S NEW FICTION BOOKS

- 1) *Lizzie At Last*, Claudia Mills
- 2) *Ghost Town*, Joan Lowery Nixon
- 3) *A Single Shard*, Linda Park
- 4) *Squire*, Tamora Pierce
- 5) *In the House of the Queen's Beasts*, Jean Thesman

Movie producer kept local roots

BY JEFF COUNTS
STAFF WRITER
jcounts@oe homecomm.net

Robert Laurel was remembered by his son Doug as not just a movie producer but also a Redford baseball coach and a man who was active in his church, St Robert Bellarmine in Redford.

Mr Laurel, 63, died while playing a pickup basketball game at the church on Tuesday. There has been no cause of death listed, said Doug Laurel.

"He played basketball at the church with a lot of guys," Doug said. "He played a lot of softball."

Although the world knew Mr Laurel as the producer of "The Rosary Murders" and as a jazz pianist, Doug said his father was a devoted baseball coach in the Redford Township Little League.

"If you were on one of his teams, you remembered it," he said.

The elder Laurel was a "pianist about town," playing at



Bob Laurel

Baker's Keyboard Lounge and the London Chop House, said his son.

When he was playing piano in the late 1970s he and longtime friend William X Kienzle, a former Catholic priest who wrote

"The Rosary Murders," joined forces to make the book into a movie.

The movie was eventually made in 1987 and was a moderate box office success.

He continued in the movies business with a production company named Murryhill and was in the process of making a movie called "Pig Man" that was to be shot in November in Dearborn. He also was involved in a movie called "Adrift: Seventy-six Days Lost at Sea," a film about a man floating on a raft in the Atlantic Ocean.

Doug Laurel also said his father recorded a CD with the London Symphony of jazz piano music.

"He had a lot of drive and different interests," said the younger Laurel.

Mr Laurel is survived by his wife of 41 years, Janet, two sons, Doug and Robert, two daughters, Janet and Christian Cavanagh, and one grandchild, Janae.

District auto program earns honors

Plymouth-Canton Educational Park's Auto Technology Program recently became the recipients of a donation of what would be valued at over \$40,000 worth of equipment.

The Ford Motor Dearborn Engine Plant donated and delivered 10 new 2000 01 automobile engines to P-CEP.

The engines, of various types, will be used in the auto classes to help students learn about the construction and operation of newer car components.

"The industrial technology classes rely on current equipment for students to learn skills that will prepare them for entry-level jobs and/or post-high school educational programs," Canton High School Assistant Principal Mary Kay Frey said.

Frey further stated that, "Much of the equipment is very expensive, so donations of this type are greatly appreciated. We've been fortunate to have both local and regional support of this nature and look forward to continuing support."

Let us know what you think with a Letter to the Editor!

OBITUARIES

DOROTHY MAI CARTER

Services for Dorothy Carter, 76, of Canton were held Aug 24 at the Schrader-Howell Funeral Home with the Rev Neil Swanger officiating.

Mrs Carter was born Dec 3, 1924 in Troy, Tenn., and died Aug 20 in Ann Arbor. Mrs Carter was a homemaker. She came to the Plymouth Community in 1954 from Tennessee. She was a member of the Plymouth Creditors and the Plymouth Elks. She loved Bingo and visiting Windsor. She was a loving mother, grandmother and great-grandmother.

She was preceded in death by her husband, James. Survivors include daughter, Sara (Frank) Hlavin of Canton, son, James (Margaret) Carter of Westland, daughter, Mary (Al) Bambach of Westland, daughter, Brenda (Don) Johnson of Plymouth, daughter, Audrey Jordan of Westland, sister, Fay Ann (Dale) Cunningham of Tenn., 11 grandchildren and 12 great-grandchildren.

Arrangements made by Schrader-Howell Funeral Home.

JOANNA SELEY

Services for Joanna Seley, 91, of Canton will be held Sept 11 at St Peter's Evangelical Lutheran Church with the Rev Paul E Schaefer officiating. Burial will be at Grand Lawn Cemetery in Detroit.

Mrs Seley was born Feb 15, 1910 in Hammond, Ind., and died Sept 6 in Livonia. She worked for Kelsey-Hayes during World War II making machine guns for military use. She came to the Canton community in 1988 from Plymouth. She has been a member of St Peter's Evangelical Lutheran Church for 17 years. She was a self-taught artist and did a little sculpting. She loved math and she and her late husband traveled all over the United States.

She was preceded in death by her husband, Robert in 1966. They had been married 34 years.

Survivors include sister, Irene Peters of Canton, several nieces and nephews and grand-nieces and grand-nephews.

Memorial contributions may be made to St Peter's Evangelical Lutheran Church.

Arrangements made by Schrader-Howell Funeral Home.

ALS ready for walk to defeat muscular disease

ALS of Michigan, which provides services to people with ALS throughout eastern Michigan, will hold its inaugural three-mile family fun "Walk to D'Feet ALS" Sunday, Sept 30, 2001, at Kensington Metropark-Martindale Beach. Registration begins at 9 a.m. and the walk begins at 10 a.m.

More commonly known as Lou

Gehrig's Disease, ALS (Amyotrophic Lateral Sclerosis) is a fatal neuromuscular disease that robs a person of the ability to move, speak, swallow and eventually breathe. The average lifespan after diagnosis is two to five years, and as of today there is no known cause or cure.

The Walk, chaired by Craig Mulhinch of Troy to honor his brother Ian Mulhinch, who has ALS, is expected to attract more than 700 walkers from around the state.

According to Mulhinch, "The Walk to D'Feet ALS is being held in 52 locations nationally. Locally, we hope to raise over \$100,000 for Michigan programs and services to benefit people with ALS and to support research into the cause and cure for this terrible disease."

Mitch Albom, national radio personality and author of *Tuesdays with Morrie* will be honorary chairman for this year's event.

There is no cost to attend the walk, however, walkers are encouraged to form teams, pick a team name and collect pledges for the walk. Prizes awarded will be based on the total amount of donations collected by individual walkers and turned in prior to the walk or on walk day.

To support Karing Kids in this year's Walk to D'Feet ALS, call ALS of Michigan at (900) 882-5764 or visit the Web site at alsfm.org.

ALS of Michigan is a chapter of the ALS Association.

CANTON 6

Ford Rd 1 Mile W of I 275 (734)

64.26 Family Twilight 4-8pm daily 931-1900

84.75 Kids & Seniors all shows

88.50 DAILY Matinee III 4pm

88.75 Students & Late Show Fri & Sat

87.00 Evenings Mon Thurs ALL SCREENS

NO PASSENGERS DIGITAL STEREO

Unlimited Free Drink & 25¢ Corn Refills

Deluxe Air Hockey Table

MOVIE GUIDE

MEN/SUVARI JUSTIN CHAMBERS

SHOWTIMES 9/09 - 9/13

THE MUSKETEER (PG 13)

ROCK STAR (PG 13)

JEEPERS CREEPERS (R)

JAY AND SILENT BOB STRIKE BACK (R)

SUMMER CATCH (PG 13)

AMERICAN PIE 2 (R)

COUPON

FREE

Bag of Buttery Popcorn

One per ad @ Canton 6

www.got1.com

DO-RIGHT

PLUMBING, HEATING & RHEEM

Cross Connection Back-Flow Prevention Water Heaters

734-451-6870

- Full Line Delta Faucets
- Pipe Repairs
- Insinkerator Disposals
- Water Lines
- Back Up Sump Pumps (Battery Water)
- Sewers
- Ejection Pumps
- Custom Showers
- Sump Pumps
- Water Heaters
- Toilets
- Sump Alarms

Don't Over Pay Give Us A Call Today!

We Do Steam Heat & Hydronic Heat Repairs

Su de Lic 2101097219

CHARTER TOWNSHIP OF CANTON

ACCESS TO PUBLIC MEETINGS

The Charter Township of Canton will provide necessary reasonable auxiliary aids and services such as signers for the hearing impaired and audio tapes of printed materials being considered at the meeting to individuals with disabilities at the meeting/hearing upon two weeks notice to the Charter Township of Canton. Individuals with disabilities requiring auxiliary aids or services should contact the Charter Township of Canton by writing or calling the following:

David Medley ADA Coordinator
Charter Township of Canton 1150 S Canton Center Road
Canton MI 48188
(734) 397 5435

Publish: September 6 and 9 2001 L109689

CHARTER TOWNSHIP OF CANTON

REQUEST FOR BID

NOTICE IS HEREBY GIVEN that the Charter Township of Canton, 1150 Canton Center S Canton, Michigan will accept sealed bids at the Office of the Clerk up to 3:00 p.m. Monday September 17th 2001 for the following:

2001 SIDEWALK GAP PROGRAM

Specifications are available at Ayres Lewis Norris & May Inc 3959 Research Park Drive Ann Arbor MI 48108. The phone number is (734) 761-1010. Bid documents are available for review at the Engineering Department on the second floor of Canton's Administration Building. All bids must be submitted in a sealed envelope clearly marked with the bid name, company name, address and telephone number and date and time of bid opening. The Township reserves the right to accept or reject any or all proposals. The Township does not discriminate on the basis of race, color, national origin, sex, religion, age or disability in employment or the provision of services.

TERRY G BENNETT, Clerk

Publish: September 2 5 and 9 2001 L109689

You've just found a way to protect your money from inflation for the next 30 years.

(Almost qualifies you as a visionary.)

Finding a way to protect your money from inflation for the next 30 years doesn't require a degree in economics. Or even a crystal ball. You just need to visit your local bank, check out the new U.S. Savings Bonds EasySaver Plan, or talk to your employer. Not only do I Bonds earn a real return over and above inflation, they're also exempt from state and local income taxes. And you can get started with as little as \$50. To find out more about I Bonds, go to www.savingsbonds.gov, or write to

U.S. Savings Bonds Guide Parkersburg, WV
26106-1328. Then relax. Because we predict a more secure future for your money.



For more information about I Bonds, visit our Web site at www.savingsbonds.gov

A public service of this newspaper





STAFF PHOTO BY BRYAN MITCHELL

At your service: *Livonia Mayor Jack Kirksey, right, and SMART general manager Dan Durks, second from right, show off the new buses, now in operation*

New SMART kneeling buses allow easier wheelchair access

New SMART buses are on the road around metro Detroit. The first 20 of 100 new buses have been received to date. Production on the next 80 will begin in September. SMART will take delivery of 5 per week until the Spring 2002.

Gillig Corp. in Hawthorn, Calif. manufactures the new buses. The Gillig buses are the low-floor design. The buses have a kneeling capability — suspensions that can drop the front end to curb level. Passengers in wheelchairs board the bus on a motorized ramp instead of a hydraulic lift. Even if the motor failed, the bus driver can manually operate the ramp. Currently, if a wheelchair lift is broken down the bus driver cannot pick up a wheelchair user. This problem exists throughout the United States where the hydraulic lift is being used.

During the next 3 years SMART is planning on replacing

its fleet with 287 new low floor buses. The new buses are heavy-duty and either 35 feet or 40 feet in length. SMART is expected to spend \$104 million to purchase the new buses. Approximately \$24 million is interest and \$80 million is capital cost. The total number of buses purchased during the contract is contingent upon the availability of federal and state funding.

"The overriding goal was to purchase the best possible bus on the market today and get the new buses on the street as soon as possible," said Dan Durks, SMART General Manager. "Our passengers will notice a significant improvement in the ride and quality of the buses."

Various parts of the buses are produced by Michigan manufacturers such as American Seating in Grand Rapids, Detroit Diesel in Redford, Vultron in Auburn Hills, Romeo Rim in Romeo and Transmatic in Waterford.

A creative purchasing agreement was used to shorten the time to replace the entire fleet. Through Municipal Services Group, SMART is able to finance the purchase of the vehicles with future federal grants. If traditional purchasing methods were used only 59 buses would be received in the first year and the total fleet replacement would have taken until 2007. The existing fleet would not have lasted that long.

THINKING ABOUT A NEW FURNACE?

LENNOX

FREE ESTIMATES
(734) 525-1930
UNITED TEMPERATURE
8919 MIDDLEBELT • LIVONIA

Red-light running significant factor in fatal traffic crashes

Forty-three percent of all fatal crashes that occurred at intersections with traffic lights in the southeast Michigan region in 2000 could be attributed to red-light running, according to traffic crash data compiled by the Southeast Michigan Council of Governments.

"We at SEMCOG hope that these statistics help to drive home the fact that there are serious problems at lighted intersections," says Paul Tat, SEMCOG executive director. "The good news is that there is a simple solution and we can all contribute — stop when the light is red."

In 1999, 49,536 traffic crashes took place at signalized intersections in Southeast Michigan, 13.9 percent of those (or 6,861) involved red-light runners. Of

the 81 crashes that resulted in fatalities, red-light runners were involved 43 percent of the time.

Each year in the United States, more than 1.8 million intersection crashes occur. In 1999, red-light-running crashes accounted for 92,000 crashes (up from 89,000 crashes in 1998), 90,000 injuries (up from 80,000 in 1998), and about 950 deaths.

The goal of the Stop Red Light Running Program is to re-establish respect for traffic signals to enhance the safety of drivers and pedestrians in communities nationwide, while reducing the number of trauma center admissions caused by this traffic problem.

In Lansing, House Bill 4598, which authorizes the installation and use of cameras on a highway or street, was introduced in 2001

and was referred to the Committee on Transportation.

In response to this legislation, SEMCOG's executive committee passed a resolution supporting the concept of unmanned traffic monitoring devices — under certain circumstances — as an additional means of reducing red-light-running traffic crashes and their severity associated with intersections regulated by traffic signals. The resolution noted that other safety measures, including traffic engineering improvements (e.g., signal light timing studies, lane improvements, sight distance evaluations, signage, etc.), education, and other law enforcement strategies have been implemented first and deemed to be inefficient in reducing red-light-running-related traffic crashes.

WANTED: 25 11th and 12th Graders

You've always known she was headed for Lawrence Tech... Who thought it would be in 11th or 12th grade?

- Earn college credits in high school
- Career preparation fully tuned to the real world
- Strong academic programs honed with the talents of practitioners in the field
- Projects that engage students directly with business and industry
- Faculty current with professional practice in the areas they teach
- Small classes that promote strong student interaction and team building skills
- A unique academic and experiential mix that gives students a real world advantage

Tuition is free, but space is limited

ADVANCED TECHNOLOGY ACADEMY
@ LAWRENCE TECHNOLOGICAL UNIVERSITY

Enroll Now
Monday-Friday
8 am-12 noon

Call 248-204-3980 for more information

When it comes to home improvement

GOOD HELP IS HARD TO FIND

START WITH A MSHDA PROPERTY IMPROVEMENT LOAN

Owner-Occupied Properties:

- Maximum loan: \$25,000
- Interest rate: 1% to 8%*, depending on income
- Income Limits: \$52,900 (urban counties) \$43,575 (rural counties)

* Annual Percentage Rates (APR) will be higher. For example, a loan of \$8,320 with an interest rate of 1% would have an APR of 1.56%

Rental Properties:

- Up to 11 Units
- Up to \$60,000 loan per property
- Interest rate: 8%*
- No income limits for borrowers

* Annual Percentage Rates (APR) will be higher. For example, a loan of \$8,320 with an interest rate of 8% would have an APR of 8.68%

MSHDA
MICHIGAN STATE HOUSING DEVELOPMENT AUTHORITY
Your Affordable Housing Partner
www.mshda.org
(517) 373-8017

Michael's
THE ARTS AND CRAFTS STORE®

40% OFF ALL Natural & Unfinished Baskets

30% OFF Silk Garden Shop Greenery

30% OFF Fruits, Vegetables & Fall Birds

30% OFF ALL "Silk" Floral Fall Bushes

50% OFF 1-lb. Green Eucalyptus Bunches

30% OFF Ribbon Bowtique Holiday Ribbon

40% OFF Bridal Elegance Ribbon or Party Bubbles

25% OFF Poster Frames

199 White Foam Board

6.99 2, 3, or 4-wick Oversize Candles

2.99 Ribbon Bowtique Holiday Ribbon

9.99 Sculpted Edge Decorative Plugs

1.99 Krylon 4-oz. Glitter Spray

59¢ Apple Barrel 2-oz. Acrylic Paint

2.99 Bernat Coordinates & Baby Soft

12.99 10-lb. Premium Slab Wax

2.99 Bernat Coordinates & Baby Soft

20% OFF Frederik's Artist Canvas

25% OFF All Ready-to-Finish Wood Birdhouses

30% OFF Memory Book Kits

99.99 850 Magnet, Lamination & Sticker System

50% OFF Your Custom Frame Moulding

40% OFF Any One Regular Priced Item

Prices Good September 9-15, 2001

Sunday 10AM-7PM
Mon-Sat. 9AM-9PM

EVENTS CALENDAR

The Perfect Gift - Michaels Gift Cards

1-800-MICHAELS



LAUREN RALPH LAUREN

TO FIND COUNTRY CHIC, GO TO THE CITY LIMITS

Quilts, barn jackets, horse prints — they've all made a run for the city limits. Like a breath of fresh air, the look just breathes posh country. Lauren Ralph Lauren quilted barn jacket in deep marsh green, sizes S-M-L, 199.00.

Wool/cashmere turtleneck in chestnut or (not shown) chipmunk brown, burgundy or marsh green, sizes S-M-L-XL, 89.00. Multicolored horse print wrap skirt in wool/rayon, sizes 4-16, 139.00. IN CAREER.

SHOP AT YOUR CONVENIENCE Just make an appointment with a sales associate to shop during before or after store hours

P·A·R·I·S·I·A·N

YOU'RE SOMEBODY SPECIAL

CALL 800-424-8185 TO ORDER ANYTIME STORE HOURS Laurel Park Place (953 7500) open Sun 12-6 Mon-Sat 10-9 FOR INFORMATION call 953 7500
CHARGE IT Parisian Credit Card MasterCard Visa the American Express® Card or Discover®

PDF1069300

OBSERVER SPORTS SCENE

Good Counsel wins

The Our Lady of Good Counsel eighth-grade varsity volleyball team finished first in the Livonia Ladywood Pre-season CYO Volleyball Tournament.

Team members are Ashley Bowles, Teresa Coppellie, Megan Hodges, Tatiana Imamura, Rachel Jeffery, Ashton Judis, Lauren Price, Courtney Ratkowiak, Nicole Rotondo and Laura Schroeter.

Donnelly-Runnion run

The Trish Donnelly-Runnion Memorial Fund Run is scheduled for Sunday, Oct. 7 at Canton's Heritage Park.

The competitions will be at 10-kilometers, 5 kilometers and a one-mile walk/run. Registration will begin at 7:30 a.m., with the 10K run at 8:45 a.m., the 5K run at 10 a.m. and the one-mile walk/run at 10:45 a.m.

Entry cost is \$15 before Sept. 30 and \$18 after, or the day of the race. All pre-paid entries will receive a long-sleeve T-shirt (late entries will receive them while supplies last).

Medals will be given to the top five finishers in the one-mile run/walk, awards will be presented to the top three places in each age division of the 5K and 10K races, with awards also given to the overall winners of the 5K and 10K.

Proceeds from the Trish Donnelly-Runnion Memorial Fund Run goes to benefit higher education and breast cancer awareness.

For registration information, call Pat Donnelly at (734) 981-4753.

Softball alumni

The Madonna University softball program is hosting its second-annual Alumni Game at 1 p.m. Sunday, Sept. 30 at Livonia Ladywood HS.

All former Madonna players are welcome to participate. For more information, any former Madonna players may call head coach Al White at (734) 432-5783.

Roller hockey

The Skating Skating II is accepting registrations for its fall youth and adult inline roller hockey leagues.

Cost is \$120 for 10 games (includes jersey, shirts for championship teams and referee fees). Youth evaluations begin Friday, Sept. 14. Ages are determined as of Jan. 1, 2001.

Adult leagues are 17 and over, also 30 and over.

Also roller skating classes are now forming, for children and adults. Six-week sessions are \$30 each, with classes from 11:15 a.m.-noon Saturdays starting Oct. 6, then following on Nov. 17, Jan. 5, Feb. 16 and April 11.

For more information, call (734) 459-6401 or visit www.skatingstation2.com.

Tryouts

Tryouts for a newly formed Michigan Indians 12 and under travel baseball team will be at 1 p.m. Sunday, Sept. 9 at Massey Field in Plymouth. The team will play approximately 50 games next summer including Little Caesars League and tournaments.

For further information call Ben Kosmalski at (734) 416-1151 or e-mail Bob Cleary at relaery79@mediaone.net.

The Canton Community Junior Baseball and Softball Association's (CCJBSA) 13 and under boys travel baseball teams will have tryouts for the 2002 season at 10 a.m. Sept. 8 at Flodin Park, located off Saltz. The team will play 40-plus games plus tournaments.

For more information call Dan Boylan at (734) 981-4855, Dave Grove at (734) 981-4471 or Ron Myers at (734) 459-4026.

The Canton Cardinals 11 and under travel baseball team will have a tryout for its 2002 squad at 9 a.m. Saturday and again at 5 p.m. next Sunday (Sept. 9) at McClumpha Field No. 2 in Plymouth Township Park. The team will play in Little Caesars a 40-50 game schedule including five tournaments.

For further information call Kevin Betz at (734) 397-5995.

The Canton Cardinals 12 and under baseball team will have a tryout for its 2002 team at 6 p.m. Sept. 9 at McClumpha Field No. 4 in Plymouth Township Park. The team will play in Little Caesars a 40-50 game schedule including five tournaments.

For more information call Don Plester at (734) 453-7089.

The Plymouth Canton Cyclones will have tryouts for their 14-year old travel baseball team at 10 a.m. Saturday, Sept. 22 at Griffin Park.

To be placed on the tryout list call John Kallsieski at (734) 981-0919.

Rocks shut out Huron in 4th for win

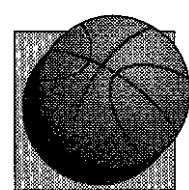

It took a while for Plymouth Salem to assert itself, but when the Rocks did in their Salem Tournament opener against Ann Arbor Huron, they did so with authority, keeping the River Rats scoreless in the fourth quarter.

BY C.J. RISAK
SPORTS EDITOR
cjrisak@oe.homecomm.net

When Brittany Tyson connected on 1-of-2 free throws with 1:26 left, she gave her Ann Arbor Huron basketball

team a one point lead.

It wasn't safe, that advantage. But it was the last point her team would score.

And if that had been the last quarter the River Rats would be playing against Plymouth Salem in the opening

round of the Salem Tournament last Thursday, it just might have been good enough. Unfortunately (for Huron, anyway), that wasn't the case, either.

The Rocks shut out their opponents over the last 9:26, outscoring them 14-0 along the way, turning what had been a close contest into a lopsided one, with Salem finishing on top by a 44-31 total.

The Rocks, who improved to 3-0, met Northville (which defeated Novi in the first game Thursday) for the tournament championship Saturday. Huron

(0-4) took on Novi in the consolation final.

"We worked through it," said Salem coach Fred Thomann, "and we've had three decent tests."

"I thought we got into a bit of a rhythm (in the second half). We started to dissect their zone a bit."

This game wasn't easy, by any means. The Rocks had two strong stretches, in the game's opening minutes and in the last quarter.

Please see **BASKETBALL, B2**

Salem at Rock bottom

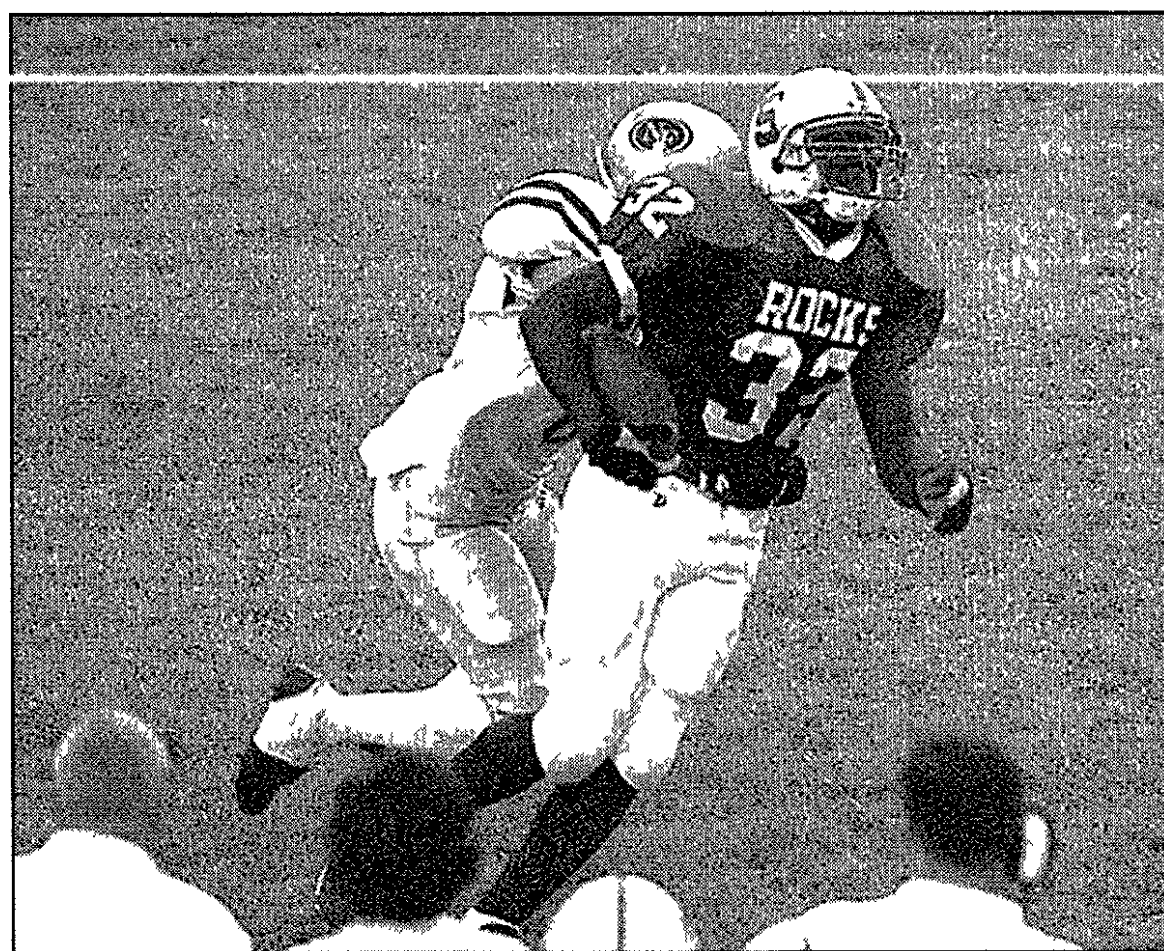

A bright spot: Not much has gone well for Plymouth Salem's football team this season, but against North Farmington Friday Myron Covington did manage to gain 82 yards rushing. Many of his runs ended like this one, with a tackle near the sideline. However, he did manage to score both of the Rocks touchdowns in the game.

STAFF PHOTO BY PAUL HURSCHEMANN

Loss to North leaves Salem at 0-3

They just didn't see it coming. And it cost them.

Bryan Smith stepped into a starting role at quarterback for North Farmington and led the Raiders to their first win of the football season Friday, at the expense of Plymouth Salem, which suffered its third-straight loss, 35-14 at Salem.

Smith, who didn't play the previous week in Plymouth Canton's 35-0 win over North, carried the ball 15 times for 139 yards and completed seven-of-11 passes for another 86 and a touchdown.

His 9-yard TD toss to Brian Johns opened the scoring in the first quarter. The extra-point attempt hit the goal post, giving the Raiders a 6-0 lead.

North led 14-0 at halftime following the first of three TD runs by senior tailback Justin Cook and a two-point run by Smith.

Cook, who had scoring runs of 5, 4 and 1 yards, gave the Raiders a 21-0 advantage with his second touchdown

FOOTBALL

in the third quarter.

Following a half hour delay because of lightning, Salem cut the margin to a 21-6 on the first of Myron Covington's two TD runs, this one from 4 yards out. The extra-point kick failed.

The Rocks tried an onside kick, but the Raiders recovered it.

"We lost a little momentum after the lightning delay," North assistant coach Rick Lee said, adding the Raiders were three and out twice.

But they regrouped and put the victory away with Cook scoring his third TD and Smith breaking loose for a 36-yard TD run with about five minutes left in the game. Covington scored from 6 yards out in between the North scores.

"It was a great team effort, from the guys starting to the guys not playing much," Lee said. "They hung together

all week long they didn't let last week's loss get to them and went back to work."

"(The win) is a confidence builder for next week. The kids tasting success early is important. It gives us a little momentum."

"It was just a hard fought game. The kids did a nice job from A to Z in all aspects of it."

Cook had 15 carries for 42 yards, but he had more than 100 total yards with punt and kick returns included. Johns caught five passes for 62 yards.

North defenders Justin Kasgorgis, Johns and Aaron Kirksey had 14 tackles apiece.

Covington finished with 82 rushing yards on 19 attempts for Salem. Hewitt was 3-of-8 passing for 91 yards, suffering one interception.

The Raiders are 1-2 and 1-0 in the Lakes Division of the Western Lakes Activities Association. The Rocks are 0-3 and 0-1.

Season's off to a fast start

Rocks win a pair by a single point; Chiefs edged by Stevenson

What a way to start the season. Certainly Plymouth Salem's boys cross country team couldn't be happier. The Rocks faced some of the toughest teams in the Western Lakes Activities Association in their season-opening quad meet at Cass Benton Thursday, and came away with three wins — two by one-point margins.

Salem edged defending WLAA champ Northville 27-28 and Walled Lake Central 28-29, then triumphed over Livonia Franklin 15-50.

Central, Northville and Salem were all without key runners, who were missing with various ailments.

Salem's Justin Hajduk finished first overall in 16:59. Next best for the Rocks was James Leddy in fifth (17:50), followed by Randy Bearden, ninth (18:05), Adam Warner, 11th (18:22), and Bill Stemmermann, 14th (18:58).

Other Rocks' runners were Mike Horgan, 16th (19:04) and Jason Poniatowski, 19th (19:22).

The 3-0 Rocks go up against Westland John Glenn in a WLAA dual meet at 4 p.m. Thursday at Cass Benton.



FILE PHOTO BY BILL BRESLER

Top threat: Salem's Justin Hajduk placed third at last year's WLAA finals.

Salem, Canton boys just might mount a WLAA title challenge

BY C.J. RISAK
SPORTS EDITOR
cjrisak@oe.homecomm.net

There's still a Warner in the lineup for Plymouth Salem's boys cross country team. Question is can Adam Warner, just a sophomore, match what his older brother accomplished.

Because the Rocks will need someone of that caliber to make a run at the Western Lakes Activities Association title.

They do have talent. At last Thursday's WLAA quad meet, the Rocks beat two of their top challengers (Northville and Walled Lake Central) each by a single point. A major part of that came courtesy of the fine running of junior Justin Hajduk, who finished first overall.

Hajduk figures to be one of the league's top runners this fall, he placed third at last year's conference finals. Question is, do they have enough to overcome their other losses?

Salem finished fourth at the WLAA finals last October even with Donnie Warner placing first overall and Hajduk third. Also missing from that lineup

Please see **CROSS PREVIEW, B2**

Please see **BOYS CROSS, B2**

Rocks open with 2 wins in 3 meets

BY C.J. RISAK
SPORTS EDITOR
cjriskaoe.homecomm.net

Four teams More than 70 runners Place 10 of yours in the top 22, and a coach has every right to think his team will beat his three opponents

It didn't quite work out that way for Plymouth Salem's girls cross country team Thursday in the Western Lakes Activities Association quad meet at Cass Benton

The Rocks did get two wins, beating Walled Lake Central 27-32 and Livonia Franklin 15-48 But they couldn't quite top Northville, losing 25-30

The Mustangs did win all three of

CROSS COUNTRY

their duals, while Central was 1-2 and Franklin went 0-3

"The race to watch was us and Northville," said Salem coach Dave Gerlach But the surprise element came from somewhere else

Salem's Lauren Kane, just a freshman, proved fastest overall, finishing first in 20:28

"I knew Lauren Kane was capable of running with the top runners from Northville and Central, but what she ran was a perfect race," said Gerlach "She's got great footspeed and she

showed a knowledge of tactics like a senior"

Next best for the Rocks, however, was Lisa Keski-Hynilla in eighth place (21:48)

Stephanie Hajduk finished 10th (21:54), Lianne Griffiths was 11th (21:57) and Kristin Mastic was 12th (22:08)

Other Rock runners Erin Jensen, 15th (22:28), Kim Wood, 18th (22:48), Halle Burton, 19th (22:51), Jill Grey, 21st (22:58), Sheena Haddad, 22nd (22:59), and Lauren Loftus, 24th (23:38)

Northville won by placing all five of its scoring runners in the top 13, including a grouping of 3-4-5

Salem takes on Westland John Glenn in a WLAA dual meet at 4 p.m. Thursday at Cass Benton

Canton goes 0-for-3

Plymouth Canton's girls ran into some difficult competition in its season-opening WLAA quad meet at Cass Benton, and the Chiefs didn't fare too well

Canton faced Livonia Stevenson and Livonia Churchill, the two teams that figure to vie for the WLAA championship, and lost both by a 15-50 score The Chiefs didn't fare much better against Farmington, losing 16-39

Stevenson emerged with the dual-meet win over Churchill by the narrowest of margins, winning 38-40 based on

the sixth-runner tiebreaker

Stevenson and Churchill runners filled the top 12 spots Canton's best finisher was Mary Maloney in 19th (22:21)

Other scorers for the Chiefs were Rachel Lindemann, 21st (22:29), Carrie Oleski, 28th (22:51), Pam Reasorm 30th (23:01), and Sara Stobbe, 31st (23:01)

Other Canton runners were Sara McCormack, 35th (23:34), Tanda Shvete, 39th (24:06), and Allison Schmidt, 42nd (24:23)

The Chiefs run next against WLAA foe Livonia Franklin at 4 p.m. Thursday at Cass Benton

Boys cross from page B1

Chiefs win 1 of 3

Plymouth Canton's fate in its WLAA season-opening quad meet against Livonia Churchill, Livonia Stevenson and Farmington Thursday at Cass Benton was decided by a single place

The Chiefs placed their four of their five scorers among the top 15, but that wasn't quite good enough as they won just one of three duals

Their win came against Farmington, 24-31 Canton lost to Churchill, 21-36, and Stevenson edged the Chiefs, 27-29

Best among Canton's scorers was Steve Debien, who was fifth

overall (17:13) Brandon McClellan placed seventh (17:30), Pat Pruitt was 10th (17:35) and Matt Rymond finished 15th (17:43) Canton's final scorer was Ross O'Hara, 22nd (18:54)

Other runners for the Chiefs were Steve Kress, 26th (19:24) and Pete O'Neill, 40th (20:27)

Churchill won by capturing the top three spots in the meet with Ryan Gall (16:42), Will Chapman (16:48) and Logan Schultz (16:58)

Canton goes against Livonia Franklin in a WLAA dual meet at 4 p.m. Thursday at Cass Benton

Cross preview from page B1

(Warner, an all-state performer, is running at Duke University) is Rob Showalter, Kurt Sarsfield and Greg Kubitski

Still, the Rocks have what it takes Impressive returnees, according to coach Geoff Baker, include Adam Warner ("He's got the drive"), juniors Jim Leddy, Randy Bearden, Chris Vraniak, Dave Anderson and Mike Horgan, and seniors Ben Brockschmidt, Bill Stemmermann and Jason Poniatowski The three seniors share the team captaincy

Among the more promising newcomers are Jason Lewis and Dave Hannon, both juniors "This year and next year are looking pretty bright," said Baker "If we stay healthy, we could make a run (at the title)"

That's the key, of course Vraniak and Hannan are currently out with ailments, but both are expected back within a week or so Both should be among the team's top 10 runners

But the Rocks' lineup could be changing weekly "With nothing really set," noted Baker, "this group should be hungrier That should push us along"

Northville, the defending WLAA champ, "looks really good — like they have the best depth, one-through-seven," Baker said, taking note of the Mustangs' strong pack Livonia Stevenson, Walled Lake Central, Livonia Churchill and Walled Lake Western all look good, too

"And that's not even throwing Canton into the mix and they're going to be pretty good"

So who's the WLAA favorite? Who knows? "It should be a great conference meet," said Baker "If we stay healthy, and we run faster than everyone else and our pack continues to improve, we'll be in the hunt"

This is one season in which the conference race is indeed wide open

Canton could challenge

No, Plymouth Canton didn't start out as well as it had hoped The Chiefs lost two of their three dual meets in their WLAA-opening quad meet Thursday at Cass Benton

But don't count the Chiefs out just yet "We're hoping to do a top three," said Canton coach Bill Boyd when asked where his team could finish in the league "The kids are hungry for success For them to go to the state meet, they'll have to beat Livonia Stevenson or Plymouth Salem — probably both of them"

But that goal is down the line a bit First there's the league to take care of

The Chiefs have lost five key runners from last season, including Scott Gillen and Brian Page But there's still plenty to build around, indeed, Boyd has 19 runners out for the team

Pat Pruitt, a senior, will be the team cap

tain Other seniors include Ross O'Hara, who missed last season with mononucleosis, Brandon McClellan and Steve Debien All could be formidable factors for the Chiefs

"The seniors have kept the other kids in focus," said Boyd

There are others who could give the Chiefs a lift Promising juniors include Aaron Lanning, another absentee with stress fractures, and Jon Western, and sophomore Matt Rymond

"We have to stay away from injuries," said Boyd, echoing a common coach's decree "I think (Livonia) Churchill is the top team, easily They have three kids under 16:45, another under 17:00

"Northville's the defending champs and they only lost two guys And Walled Lake Western has the Naughton brothers (Kevin and Neal) — they could go 1-2 at the league meet"

Canton could figure in the top five "We were a very disappointing seventh (last year)," noted Boyd "Injuries got to us — we didn't have anyone left

"We don't have the depth we had last year We were 5-2 in duals, but we'll have to stay healthy to match that"

With so many teams in the WLAA title hunt, expect more than a few surprises this season In that regard, Canton hopes to give more than receive

SALEM GOLF

In a Western Lakes Activities Association golf match that was rescheduled for Friday, Plymouth Salem probably wishes it had left things alone and as they were instead of changing them after losing 157-163 to Walled Lake Western at Bay Pointe Country Club

Only one of the Rocks broke

40, which wasn't nearly good enough Joe Deane led Salem with a 39, Bobby Jones and Jon Gordon each shot a 41, with Andy Thackaberry next at 42 Dave Wong's 44 and Ryan Williams' 45 were non-counting scores

Salem is supposed to play in the Adrian Invitational Monday

Basketball from page B1

Salem scored the first seven points of the contest and led 9-1 following a basket by Mary Lou Liebau with 3:51 left in the first But Huron got rolling, outscoring the Rocks 11-2 through the rest of the period for a 12-11 lead after one Tyson and Jessica White each had four points in the River Rats' run

It stayed close the entire second quarter, neither side leading by more than three and Huron clinging to a 20-19 halftime edge However, it was becoming evident Salem would get its points from either Liebau or Kelly Jaskot (they combined for 38 of the Rocks' 44) and that Huron was going to win if some-

thing was done to counteract its dominance of the boards

"We really talked about that at halftime," said Thomann "We had to start getting a body on a body"

There were no signs of immediate improvement in the third quarter The River Rats, using a variety of zone defenses, kept the Rocks on the perimeter while they drove through Salem's man-to-man, getting two and three shots a possession at the basket

White's putback with 3:36 left in the third allowed Huron to match its biggest lead of the game, 28-25 But Jaskot drained that away with one easy stroke, swishing a three-pointer 20 sec-

onds later to knot it at 28-all

With 1:11 left in the third Amy Szawara nailed a jumper from the corner to give Salem a 32-31 lead going into the fourth Huron would never overtake it

Jaskot and Liebau combined for all the points scored in the final period, each scoring six Huron, which was on 12-of-35 (34.3 percent) from the floor in the first three periods, was 0-for-10 in the fourth

Liebau finished with a game-high 20 points and 12 rebounds for Salem, which hit 16-of-50 from the field in the game (32 percent) Jaskot scored 18, including three three-pointers

Huron got nine points from Tyson and eight more from White

trailing host Detroit Urban Lutheran 7-4 — with a strong second period outscoring their opponent 13-3 to take a 17-10 halftime lead

Agape was never threatened the rest of the way as it improved to 3-1 Urban Lutheran is 2-2

Amy Henry led the Wolverines with 10 points, she also had nine steals Lisa Ther had nine points Desiree Mitchell's 12 points topped Urban Lutheran

"We shot poorly," said Agape coach Chuck Henry, noting his team's 15-for-65 performance (23.1 percent) "They were very quick It was a sloppy game"

It must have been — Agape committed 21 turnovers

Flat Rock 60, PCA 43: Shannon Brodie poured in 11 first-quarter points as host Flat Rock jumped to a 21-8 lead, increasing it to 35-16 by halftime as the

Rams improved to 2-1 at Plymouth Christian Academy's expense Thursday

PCA fell to 1-3

"The first half kind of killed us — really the first quarter," said PCA coach Annie Malcolm "I thought they were pretty tough They're a Class B school"

Brodie, whose father Bob is the Plymouth Salem HS boys basketball coach, finished with a game-high 18 points Danielle Miller scored 15 and Autumn Hudson netted 11

The Eagles got 14 points from Amy Brandt in her best offensive performance of the season Amanda Saagman had nine and Shannon Murray totaled eight, both getting all their points in the second half when PCA outscored Flat Rock 27-25

"That was probably our best game so far (this season)," said Malcolm "I'm proud of their effort and the fact that they didn't quit

despite the (odds) We pretty much knew we couldn't come back and win that game We just wanted to play hard, come out and have fun — and we did

Ladywood 76, Flint NW 40: Senior center Laz Obrecht dominated at both ends of the court Thursday night in leading the host Blazers to their third win in four tries

Obrecht scored 20 points and pulled down 15 rebounds to lead Livonia Ladywood, which raced out to a 41-20 halftime lead The Blazers held the Wildcats to just three field goals in the second half

Nikki Watts added 13 points for Ladywood, Ruth Sventickas had 10 and Lauren Hesano eight Amy Jacovetti scored seven, all in the first half

Flint Northwestern (1-3) shot 27 free throws and made 16 Ladywood made 6-of-11

Bathtub Liner & Wall Surround Sale!

Factory Direct Pricing To The Public
Cut Out The Middleman...Save Up To 50% Off Retail Prices!

CHECK THE BUDGET ADVANTAGE

- ✓ Tough acrylic won't chip, crack or fade
- ✓ Easy cleaning with safe cleaners
- ✓ Classic neutral color choices
- ✓ Optional non-slip bottom promotes home safety
- ✓ The glossy acrylic is non-porous and does not allow growth of mold and mildew
- ✓ Acrylic is scratch-resistant, the finish can also be polished for an ultra-shine
- ✓ Perfect fit over old tub
- ✓ Highly affordable

• Lifetime NON-PRORATED Transferable Warranty

COMPLETE LINE OF

- Bathtub Liners
- Shower Base Liners
- Bath Wall Systems
- Shower Doors
- Vanities & Countertops

FREE Decorative Curved Shower Rod with any complete system (\$89.00 Value)

ONE DAY INSTALLATION
Use and Enjoy your bathroom the same day!

NO MESS NO INCONVENIENCE

FREE Estimates
Special Senior Discounts

Budget has the perfect solution! We will install a beautiful, new acrylic bathtub liner RIGHT OVER your old, worn or damaged tub! Your existing tiles, flooring, and plumbing will not be disturbed.

6 in. ACRYLIC TUB LINER
Sale \$389*
From \$796 Installed
One Week Only
Reg. price \$796. Sale price good at time of estimate. Straight Sides, White. Additional Charge For Color Formed Sides, Drain/Overflow. Previous orders excluded. *Walls priced separately.

As Seen On T.V.

Budget™ BATHTUB LINERS

CALL TOLL FREE 1-800-BATHTUB (228-4882) FREE ESTIMATES

Visit Our Beautiful Showrooms...Open Sunday 11-5

25170 John R. • Madison Heights • 248-546-8300

Lincoln Park 313-382-8100 Grosse Pointe 313-882-4454 Dearborn 313-561-7789 Toledo 419-886-4211

Shuttle Service to MotorCity Casino

\$5.00 per person includes:

- \$3.00 Shuttle Fare
- Free All-You-Can-Eat Buffet
- Luxury Motorcoach Transportation

Buses depart from:

Ann Arbor • Brighton • Canton • Clinton Twp
Dearborn • Flint • Lansing • Livonia • Pontiac
Roseville • Saginaw • Southfield • Southgate
St. Clair Shores • Sterling Heights • Taylor • Westland

New shuttle lines added:

Farmington • Jackson • Monroe • Port Huron • Troy • Warren • Ypsilanti

DON'T FORGET TO ASK ABOUT OUR NEW SATURDAY DEPARTURES!

MOTORCITY casino

For times, locations and reservations call

1-800-254-3423

Open Sundays

Service provided by Casino CruiseLine and is not affiliated with MotorCity Casino. Certain restrictions apply. Must be 21 years old. Visit us at motorcitycasino.com

Opening Night

Plymouth Whalers

Get Hooked

Featuring a rematch of last year's Western Conference Finals. Come meet Angela and Rocks from Nickelodeon's top show.

Saturday, September 15

vs

Erie Otters

Puck drops at 7:30 p.m.
Pre-game starts at 6 p.m.

Family Value Night: 4 tickets, 4 Hot Dogs, 4 Pepsi's and 2 game programs for only \$36!

Individual Tickets just \$8 and \$12
All fans in attendance will receive a free magnet schedule!

Call (734) 453-8400
to charge tickets by phone

Dearborn upends Salem in dual opener

As warm-ups go, this dual meet really got things moving. Plymouth Salem met Dearborn in a season-opening, non-league girls swimming dual meet Thursday at Salem, two days before the Rocks were to host the annual Western Lakes Activities Association Relays. With the score literally changing with each event, the meet was ultimately decided when the Pioneers

SWIMMING

outscored Salem in both the 100-yard backstroke and 100 breaststroke. The final score Dearborn 95 Salem 91. "I thought it was a good meet," said Salem coach Chuck Olson. "It was an

entertaining first meet. I mean, dual meets really don't mean much except you want to swim well, and we did. "I was pleased with the effort we got. We found some freshmen who will contribute." Salem got wins in the 200 free and 100 butterfly from Monica Glowski. She won the 200 free in 2:05.34, and she captured the 100 fly in a state-qualifying 1:01.52.

The Rocks also got a win from Jenny Crabill in the 100 breast (1:19.86), with their team of Glowski, Alicia Dotson, Nicole Genrich and Danielle Powers finished first in the 200 free relay (1:47.89) and their foursome of Glowski, Dotson, Powers and Crabill taking the 400 free relay (3:57.44). However, Dearborn — which trailed

Salem 71-69 after the 200 free relay — collected the top two spots in the 100 back in outscoring the Rocks 11-5 in the event. After that the Pioneers went 2-3-4 in the 100 breast to outpoint them 9-7, which gave them an 89-83 lead (the biggest advantage by either team) going into the final event. Salem swims at Plymouth Canton at 7 p.m. Thursday.

SC jolts St. Clair CCC

Well — St. Clair County CC may have won the first two volleyball meetings against Schoolcraft College, but the Lady Ocelots struck back by beating the Lady Skippers 26-30, 30-28, 30-25, 30-23 Thursday at St. Clair.

The win boosted SC's record to 7-2 in matches, 1-0 in the Michigan Community College Athletic Association's Eastern Conference.

Fran Hamilton led the way for the Ocelots with 20 kills, she also had 10 digs and two blocks. Andrea Kmet (Livonia Franklin) added 17 kills, 10 service aces, 20 digs and two blocks, Noelle Swartz (Canton/Westland John Glenn) had 10 kills (a 34.8 kill percentage), Carly Szajnecki had

VOLLEYBALL

10 kills and four blocks, Kellie Kern had 31 set assists, six kills, 16 digs and two blocks, and Ioana Vescan totaled 25 set assists and four aces. SC had lost twice to St. Clair County CC, the defending NJCAA Division II champion, at last year's St. Clair CCC Tournament. The Ocelots avenged those Thursday.

Madonna buries Cougars

Madonna University opened its Wolverine-Hoosier Athletic Conference season with a lopsided sweep of host Spring Arbor College, 30-16, 30-19, 30-23 last

Tuesday. The win pushed the Lady Crusaders over the 500 mark at 5-4 overall.

Donna Birkenhler paced Madonna with 13 kills (a 39.1 kill percentage). Tera Morrill (Livonia Franklin) had eight kills (31.6), five service aces and nine digs, Marylu Hemme (Plymouth/Livonia Ladywood) contributed five aces and six digs, Amanda Suder (Plymouth Salem) got 13 digs, Denise Gallagher totaled 12 digs, and Jennie Wind finished with 28 set assists and six digs.

The Crusaders hosted the Julie Martin Memorial Tournament this weekend. Results will appear in Thursday's Observer.

Canton among state's elite

The state soccer rankings haven't come out yet, but it's a good bet Plymouth Canton will be near the top in Division I.

The Chiefs kept rolling on Wednesday, scoring four times in each half to rout visiting Livonia Churchill, 8-0.

Canton is 6-0 overall and 1-0 in the Western Division of the Western Lakes Activities Association. Churchill slips to 1-4 and 0-1.

Seniors Nahshon Washington and Nick Rolfe each scored a pair of goals for Canton.

"Canton is a good team and they were ready to win at the start," said Churchill coach Reid Friedrichs, who was missing three key players to injury. Canton was simply faster than they beat us to every ball.

"They've beaten Troy, Troy Athens, Ann Arbor Pioneer, (Midland) Dow and (Warren) DeLaSalle — five of the top 15 teams in the state. If they're No. 1, they've earned it."

Stevenson 10, John Glenn 0: Teamwork was the name of the game Thursday as host Livonia Stevenson rolled to an easy triumph over Westland John Glenn.

SOCCER

Ben White pumped in four goals for the winners, while J.T. Katkos added two. Paul Johnson, Jon Spray, Nik Djokic and Brian Ennis also scored for the Spartans, now 3-0 overall and 1-0 in the Lakes Division of the Western Lakes Activities Association.

"I was pleased with our play because we were unselfish around the box and it resulted in a number of goals."

Goalkeepers Charlie Knoll and John Magoulick each played a half to combine on the shutout.

Garden City 3, John Glenn 2: Danny McCall had a bittersweet afternoon for Garden City on Friday.

He scored the game-tying and winning goals for the Cougars in a 3-2 win over Garden City but twisted his knee in the late going.

"Hopefully he'll be able to play on Wednesday," said Cougars coach Bill Tornai as his team improved to 4-0. "He did it all in that game, scored two goals and played goal for a while in the

second half." After the Rockets took a 1-0 lead, Garden City tied it in the 17th minute as Brent Reynolds converted a pass from Jamie Miller for a 1-1 halftime lead.

Glenn came back in the 58th minute with a goal and a 2-1 lead, but McCall scored the tying marker in the 65th minute, then the game-winner two minutes later.

Josh Dodson made 11 saves in goal for the Cougars, who had 12 shots on the John Glenn goal.

RU 10, C'ville 0: Redford Union's youth was still more experienced than Livonia Clarencville's as the Panthers wound up with a 10-0 shutout win on Thursday.

Aldo Meradiegue led RU (10) with three goals and two assists, while Chris Jackett, Plamen Mitev and Tony Carignan had two goals each. Dylan Borland added a final goal, while Brian Stephens had five assists on the game.

Jason Dunning stopped the only shot against him in goal for RU, while the Panthers had 20 more shots on goal in the contest.

Canton grid

from page B1

direction, one more friendly to Northville. The Mustangs gave up yards grudgingly to Canton but, early in the second quarter, they stopped the Chiefs on downs at their own 12.

Sparked by quarterback Drew Herpich (and aided by a personal foul penalty against Canton), Northville marched out of its own end, driving to the Chiefs' 16, where it faced second-down-and-8. However, Herpich couldn't connect with his receivers after that, throwing three-straight incompletions to turn the ball over on downs.

The tide was beginning to turn.

But it didn't just yet. Canton struggled on its ensuing possession, failing to pick up the first down and punting. Northville took possession at its own 42 with 3:39 left in the half.

On their first play, Herpich's pass, an out-pattern intended for Brandon Ajlouny, was picked off by Kyle Lasko and returned 59 yards for a touchdown. Brendan Murphy's two-point conversion pass to Dave Reeser was good, and Canton's lead was 14-0 with 3:28 left.

The Mustangs got possession back at their own 31 with 3:23 left. They kept the ball one play.

A fumble was recovered by Canton's Todd Shirkman at the Northville 31. Four plays later the Chiefs were in the end zone again, this time Dane Kobus scoring on a 10-yard run. Kachhal's placement was good and, with 1:53 still remaining, Canton led 21-0.

Northville took possession after a good kickoff return at the Canton 48. However, two sacks and a pass completion that gained nothing left the Mustangs facing fourth-down-and-distant with about 30 seconds left. Herpich tried a long pass but Lasko picked it off again, returning it 36 yards, from the Canton 25 to the Northville 39.

After a pass completion moved it 10 yards to the Mustang 20, Murphy found Chris Smilo on a fade route that Smilo hauled in for the touchdown — a drive that took two plays and 13.3 seconds. Kachhal's extra-point kick made it 28-0 at the half.

The third quarter was scoreless, with each team driving deep into their opponents' territory only to come away pointless. Northville's best drive of the game ended when Herpich's quarterback sneak on fourth-and-1 was stuffed at the Canton 12 on the first play of the fourth quarter.

The Chiefs responded with an 88-yard scoring march, highlighted by Reggie Joyner's 59-yard scamper on the very first play that gave Canton a first down at the Northville 29. Four plays moved it to the 7, from there, Fuller plunged through the middle for his second TD of the night and, with 9:20 left, Canton's lead was 34-0.

Two more scoring drives followed, the first covering 68 yards and ending with Doug Davidson's 16-yard TD run with 5:07 to play. The next was far shorter — just two plays for 48 yards, the key a 44-yard scoring run by

Kyle Whitlock with 1:14 remaining. A bad snap on the conversion kick resulted in a two-point pass and a 49-0 score.

"We've been known for our offense, but our defense has taken command," said a pleased Baechler.

Indeed, Canton limited Northville to 19 yards rushing on 23 attempts. The Mustangs completed 10-of-23 passes for 101 yards, missing three interceptions and one fumble. They had just eight first downs.

Canton gained 400 rushing yards, 206 of those coming in the fourth quarter. Joyner led the way with 128 on 11 carries, but he had plenty of company. Kobus had 14 attempts for 95 yards, Whitlock carried twice for 52 yards, Fuller finished with 12 tries for 47 yards, and Davidson collected 45 yards on two tries.

Murphy completed 2-of-7 passes for 41 yards and one TD. Canton had 17 first downs.

Of course, the cloud Canton is currently floating on could dissipate quickly against a Harrison team that is being called perhaps the best in school history — and that's a history that numbers 11 state champions.

"We weren't really that up for this week," Baechler said. "Even after (losing) last year. They were calm, focused."

"It'll be the same this week, we'll prepare the best we can. We know we aren't supposed to win. We'll just do the best we can."

Someone has to give Harrison a battle. Might as well be Canton.



Novi Expo Center



Saturday, Sept. 15, 2001

10 am - 6 pm

Join Us For A Day of Family Fun & Entertainment

- **MAIN STAGE** acts that include The "Rockin Scooby" show featuring the Hanna-Barbera cast of characters, Foley the Fabulous magician, MadScience, and much more!
- **CLUB WOW** — a state-of-the-art disco and dance floor featuring a DJ playing the latest pre-teen dance tunes and karaoke for the kids.
- **KIDS CENTRAL** — a huge interactive play area that includes Toddler Town, the WOW Arcade featuring electronic games, inflatable slides & jumping house, and an Art Gallery for creating masterpieces!
- **BOOK NOOK** — incorporating fun into reading...storytelling, character appearances, authors, and highlights of the latest children's books.
- **COOKING CORNER** — featuring easy, fun, and healthy snacks that both kids and parents alike will love!
- **INTERACTIVE EXHIBITOR AREA** — dozens of local and national companies displaying the latest family-focused products and offering hands-on interaction.

Presented By: 

Saturday, Sept. 15, 2001

Novi Expo Center • Novi, Michigan

10 am - 6 pm

Children's Free Admission Voucher

(\$3.50 value)



Present this voucher at the door. Voucher admits up to two children (aged 13 & younger) free with an adult ticket purchase (adults are \$5).

visit our website at www.wowfestival.com

HEY HOCKEYTOWN

October & November

Tickets On Sale Now!

Wed., October 10 ~ vs. Calgary	@ 7:30 PM	
Fri., October 12 ~ vs. Buffalo	@ 7:30 PM	
Tue., October 16 ~ vs. Columbus	@ 7:30 PM	
Thurs., October 18 ~ vs. Philadelphia	@ 7:30 PM	
Sat., October 20 ~ vs. Los Angeles	@ 7:30 PM	
Wed., October 24 ~ vs. Edmonton	@ 7:30 PM	
Fri., October 26 ~ vs. Dallas	@ 7:30 PM	
Fri., November 2 ~ vs. NY Islanders	@ 7:30 PM	
Tue., November 13 ~ vs. Carolina	@ 7:30 PM	
Fri., November 16 ~ vs. Minnesota	@ 7:30 PM	
Sat., November 17 ~ vs. Los Angeles	@ 7:30 PM	
Tues., November 20 ~ vs. Nashville	@ 7:30 PM	
Fri., November 23 ~ vs. St. Louis	@ 7:30 PM	
Sun., November 25 ~ vs. Chicago	@ 6:00 PM	
Tues., November 27 ~ vs. Calgary	@ 7:30 PM	
Fri., November 30 ~ vs. New Jersey	@ 7:30 PM	

Joe Louis Arena

Tickets are available at the Joe Louis Arena box office, all **ticketmaster** outlets, including Hockeytown Authentics in Troy (with no service charge) and by logging on to www.detroitredwings.com, or charge by phone.

248-645-6666

Impact of Farmington decision uncertain

BY BRAD EMONS
SPORTS WRITER
bemons@oe.homecomm.net

What does the future hold for the Western Lakes Activities Association following the impending departure of the three Farmington schools to the Oakland Activities Association?

"I hope the 12 teams remain solidified because if anybody else goes it could have a dramatic impact," Livonia Stevenson principal Steve Archibald said. "We don't want the strength of the league to change."

"And hopefully after our meeting on Monday we'll have a clear direction and decision on their part soon."

North Farmington, Farmington and Farmington Hills Harrison have submitted a "letter of interest" to join the 28-school OAA. In what could become a mere formality, the Farmington trio will learn of its fate when the OAA board of governors meet on Oct. 11.

Meanwhile, principals in the WLAA will be meeting on Monday to discuss what is next for the 2002-03 school year. The WLAA's athletic directors will also meet on Wednesday.

It was only last week that Farmington Public Schools Athletic Director Brian Swinehart notified WLAA members of his district's intentions.

Last fall, Swinehart was on a committee to revamp and reconstruct divisional alignments for the WLAA, which will eventually expand to 15 schools for the 2002-03 school year.

That's when two new schools Plymouth and

LEAGUE SHUFFLING

Walled Lake Northern, become members, along with Wayne Memorial of the Michigan Mega Conference.

The league currently consists of 12 schools. Lakes Division — Farmington, North Farmington, Stevenson, Plymouth Salem, Westland John Glenn and Walled Lake Central.

Western Division — Harrison, Walled Lake Western, Livonia Churchill, Livonia Franklin and Plymouth Canton.

Following months of meetings last spring, principals of the WLAA decided to divide the 15 schools into three divisions each based on past performance standards in all sports along with a provision that schools in the same school district would not be aligned within in the same division.

But the Farmington Public Schools, after digesting the package over the summer, apparently balked at the compromise plan and decided to initiate interest in going to the OAA, which aligns schools in divisions by each individual sport based on past record.

Data provided recently to the Observer documents the success rate of all 12 WLAA schools from the 1993-94 school year through 1998-99.

The three schools at the top include Stevenson, 27 conference and 23 divisional titles, Salem, 23 and 18, Canton, 17 and 26.

The next three include Walled Lake Central, 12

conference and 14 divisional titles, Harrison, 11 and 15, Northville, seven and 18.

The bottom six include North Farmington, five and three, Churchill, four and five, John Glenn, two and seven, Walled Lake Western, one and four, Farmington, zero and three, and Franklin, one division title.

Apparently the Farmington schools did not feel the equity of competition issue was full addressed. "As I recall one or two Farmington principals voted for the final resolution," Churchill principal Rod Hosman said. "When we were done I don't think that's what they (Farmington) wanted. Hey, it's not everything we wanted either, but it was something everybody pretty much could live with it. And that's what a good compromise is all about."

If the three Farmington schools, the three lowest enrollments within the existing WLAA, do pull out and join the OAA, that leaves the WLAA with only 10 varsity programs next school year.

Both Walled Lake Northern and Plymouth High won't field full-fledged varsity teams until the following year 2003-04.

"There may be some disruption, the main concern is scheduling," Hosman said. "But I feel good about the schools who are left."

"I feel they're committed and I think we'll be fine."

John Glenn athletic director Gerald Szukaitis said the news about the Farmington Schools leaving "comes as a surprise."

"Brian (Swinehart) assured us last spring it was

a dead issue," Szukaitis said. "But apparently the Farmington principals were not happy with the recommendations and the A D's weren't either."

"I was on the realignment committee and it was disappointing to me that the A D's proposal was not accepted by the principals."

"I've said I'm for realigning by sport and by past record. The downside is you don't know where you're going (division-wise) every couple of years. Everything is pretty new."

Fellow WLAA A D's and administrators can only speculate the real reasons for the Farmington Schools' impending departure.

"Obviously they feel it's in their best interest, but I can't tell you the real motivation," Hosman said. "I could speculate that their superintendent (Robert Maxfield) has a strong Oakland County background coming from Berkley and he has a tighter association with their superintendents. They probably feel it's better for those schools, and their coaches think they will be more competitive. Their coaches have been doing a lot of talking."

Szukaitis said football and boys basketball carries more weight.

"That's the first thing people look at," the Glenn A D said. "The thing that sets off most emotions is football."

And if there is one sport and one program that has been at the top of the WLAA longer than any in its history, it's Farmington Harrison football.

But unfortunately with open enrollment within the Farmington Public high schools, North Farmington and Farmington have not kept pace

RUNNING RESULTS

RUN LIKE THE WIND

10-KILOMETER RUN

Sept 1 at Nankin Mills

Male overall winner 1 Thomas Preiss age 32 33 minutes 45 seconds

Female overall winner 20 Susan Tatigian age 34 42:36

OTHER TOP MALE

AGE-GROUP FINISHERS

15-and-under 40 Matt Sova 45:34

16-19 44 Jeff Nichol 46:46

20-29 2 Lee Shaw 35:45 11 Craig Dolecki 38:09 41 Scott Thurnauer 45:42

30-39 3 Karl Zubal 36:26 12 Jon Vasquer 38:21 23 Tim Hermann 43:04 25

Matt Hagood 43:05 26 Rick Wynns 43:06

40-44 4 Rick Armes 36:45 5 Bob Schwartz 37:00 6 Tobin Jones 37:16 7 Kurt Schneider 37:17

45-49 8 John Tarkowski 37:34 15 Bob Herman 39:28 16 Rick Straub 40:08 20 Paul Alexander 42:14 28 Larry Barnett 43:24

50-54 42 Jim Dixon 45:43 65 Bob Votruba 50:57 72 Norman Werner 52:01 75 Robert Pruneau 53:08 76 Art Mackie 53:12

55-59 14 James Carlton 38:51 22 Dominic Vella 42:53 24 Leo Zehnder 43:05 39 Dennis West 45:34 46 Allen Tavemer 46:58

60-64 57 Giles Wilborn 48:36 67 John

Wehrly 51:13 81 Tom Gerick 54:28

65-69 68 Marvin Stevenson 51:24 115 Bob Littky 1:05:35 121 David Miller 1:13:26

Others in the top 30 10 Steve Zacharias age 40 (38:06) 18 Ken Sova age 44 (41:25) 19 George Sveda age 40 (42:38) 29 Gerry Hermann age 35 (43:43) 30 Kevin Sherwood age 39 (43:42)

OTHER TOP FEMALE

AGE-GROUP FINISHERS

15-and-under 111 Mollie Hagood 1:03:09

16-19 117 Anne Lieberman 1:08:55

20-24 71 Bridget Pesta 51:55 105 Holly Pettilio 59:49

25-29 33 Jennifer Bunner 44:16 70 Amy Gluck 51:53 95 Michelle Schurstein

57 41 98 Michelle Riggs 58:27

30-34 58 Karen Eekhoff 48:43 89 Kann Nelson 56:16 94 Jill Flatt 57:33 97 Michelle Thurnauer 58:26 101 Leza Rebers 59:10

35-39 32 Lemon James 44:11 60 Carrie Somers 49:06 69 Janet Poldon 51:52 86 Deb Amell 55:21 118 Davis Strum 1:09:55

40-44 93 Grace Tocco 57:22

45-49 100 Carol Suarez 58:54 107 Jan Ford 1:00:32

50-54 106 Christine Redmond 59:50

113 Kathleen Taverner 1:04:22

55-59 83 Kathleen Morse 54:53 103 Nancy Teel 59:34 109 Karen Hill 1:00:50

60-64 108 Sandra Somers 1:00:33

65-69 92 Chris Swanson 57:11

SOCCER NEWS

Wanted: players

The Wayne-Westland Strikers, an under-13 girls select soccer team, is seeking players for the upcoming season.

Interested players (must be born after Aug. 1, 1988) should call coach Mark Allen at (734) 722-6762.

Total Soccer clinics

Total Soccer of Wixom, located at 30990 Wixom Road, will stage

45-minute weekly clinics stressing basic skills and individual development for ages 2-10 beginning Monday, Sept. 10.

Cost for the seven-week clinics are \$79 (includes T-shirt).

For more information or to register, call (248) 669-9817, or email tswixom@bignet.net

To submit items to the Sports Scene, write 36251 Schoolcraft Rd., Livonia, MI 48150, or send via fax to (734) 691-7279.

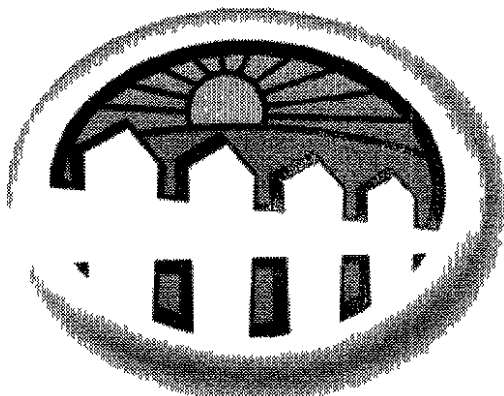

HomeTownLife.com INTERNET ADDRESS DIRECTORY

ACCOUNTING
Bovitz & Co CPA PC www.bovitzcpa.com
Sosin Sklar Rottman Lifer & Kingston PC <http://www.ssrk.com>

ACUPUNCTURE
Carl J Sarnacki M.D. www.americanacupuncture.com

AD/HD HELP
AD/HD (Attention Deficit) www.adhdoutreach.com

ANNOUNCEMENTS
Legal Notice <http://www.oeonline.com/~legal>

ANTIQUES & INTERIORS
Watch Hill Antiques & Interiors www.watchhillantiques.com

APARTMENT
Can Be Investments -- www.canbe.com

ARCHITECTS
URS Greiner Woodward Clyde www.urscorp.com

ART and ANTIQUES
ART GALLERIES
The Print Gallery www.everythingart.com

ART MUSEUMS
The Detroit Institute of Arts www.dia.org

ASPHALT/CONCRETE PAVING
Ajax Paving Industries www.ajaxpaving.com
S&J Asphalt Paving <http://www.sjaspaltpaving.com>

ASSOCIATIONS
ASM Detroit www.asm-detroit.org
Asphalt Pavers Association of Southeastern Michigan <http://www.apamichigan.com>
Oakland Youth Orchestra www.oyormi.org
Suburban Newspapers of America www.suburbannews.org
Suspender Wearers of America -- <http://www.suspenders.com/swaa>

ATTORNEYS
Nichols & Eberth PC www.nicholsattorney.com

AUDIO VISUAL SERVICES
AVS Audio www.avsaudio.com

AUTOMOTIVE
Auto Warranty Extend www.htnews.com/autoextend
Competition Limited www.htnews.com/compittd
Great Lakes Components www.greatlakescomponents.com
John Rogin Buick Isuzu Suzuki www.johnrogin.com
Livonia Chrysler -- www.livoniachrysler.com

AUTO RACING
Milan Dragway www.milandragway.com

BAKING/COOKING
"Jiffy" Mix - Chelsea Milling Company -- www.jiffymix.com

BOOKS
Apostolate Communications www.apostolate.com

BUILDING PRODUCTS
Lenover's Professional Building Products [lenovers.com](http://www.lenovers.com)

BUSINESS NEWS
Insider Business Journal -- www.insiderbiz.com

COMPUTER HARDWARE/PROGRAMMING/SOFTWARE SUPPORT
Thermal Engineering Services Inc [tesinet.com](http://www.tesinet.com)

CHAMBERS OF COMMERCE
BirminghamBloomfield Chamber of Commerce www.bbccc.com
Garden City Chamber of Commerce www.gardencity.org
Livonia Chamber of Commerce www.livonia.org
Redford Chamber of Commerce [redfordchamber.org](http://www.redfordchamber.org)

CHILDREN'S SERVICES
St Vincent & Sarah Fisher Center <http://www.oeonline.com/svsvf>

CHILD SAFETY ITEMS
Knifesafe www.knifesafe.com

CLASSIFIED ADS
Advillage <http://www.advillage.com>
Observer & Eccentric Newspapers http://www.oeonline.com/observer_eccentric.com

COMMUNITIES
City of Birmingham <http://www.cityofbirmingham.mi.us>

COMMUNITY NEWS
HomeTown Newspapers <http://www.htnews.com>
Observer & Eccentric Newspapers http://www.oeonline.com/observer_eccentric.com

COMMUNITY ORGANIZATIONS
Visions of Suanne Big Crow <http://www.suannebigcrow.org>

COMMUNITY SERVICES
Beverly Hills Police www.beverlyhillspolice.com
Detroit Regional Chamber www.detroitchamber.com
Hearts of Livonia www.heartsoflivonia.org
Sanctuary- <http://www.oeonline.com/~webscool/teenhelp>

COMPUTER GRAPHICS
Logix Inc www.logix-usa.com

CREDIT BUREAUS
Ann Arbor Credit Bureau -- www.a2cb.com

COMPUTER PRODUCT REVIEWS
CyberNews and Reviews <http://www.oeonline.com/cybernews>

CRAFTS
Linden Lane Farms -- www.fibersofmichigan.com

CRYOGENIC PROCESSING
Cryo tech Inc www.cryofrz.com

DENTISTS
family dentistry -- www.familydentist.sinardds.com
Pinkney Greenbaum and MacFarland www.cantondentists.com
Smile Maker www.smilemaker.org

DOLLS
Toy Wonders of the World Inc www.toywonders.com

EDUCATION
Global Village Project <http://www.oeonline.com/gvp.htm>
Oakland Schools -- <http://www.oakland.k12.mi.us>
Reuther Middle School <http://www.oeonline.com/~rms>
Rochester Community <http://www.rochesterhills.com>
The Webmaster School <http://www.rochesterhills.com>
Western Wayne County Internet User Group <http://www.oeonline.com/wwcuiug>

ELECTRICAL SUPPLY
Caniff Electric Supply -- www.caniff.com
Progress Electric www.pe-co.com

ELECTRONIC SERVICE AND REPAIR
ABL Electronic Service Inc www.ablerv.com

EMPLOYEE LEASING COMPANY
Genesys Group -- www.genesysgroup.com

EMPLOYMENT SERVICES
Advantage Staffing -- www.astaff.com
Employment Presentation Services www.epsweb.com
HR ONE INC www.hroneinc.com

ENVIRONMENT
Resource Recovery and Recycling <http://www.oeonline.com/rrasoc>

EYE CARE/LASER SURGERY
Greenberg Laser Eye Center www.greenbergeye.com
Michigan Eyecare Institute www.micheyecare.com

FINANCIAL
Fairlane Investment Advisors Inc -- www.fia.com

FLOORING
Dande Hardwood Flooring Company www.dandefloors.com

FROZEN DESSERTS
Savino Sorbet -- www.sorbet.com

GALLERIES
Cowboy Trader Gallery www.cowboytradergallery.com

GOVERNMENT
Livingston County Human Services [livcounty.org](http://www.livcounty.org)

HEALTH CARE
Family Health Care Center <http://www.oeonline.com/ehrmann>

HERBAL PRODUCTS
Nature's Better Way <http://www.oeonline.com/nbw>

HOME ACCESSORIES
Laurel Home Accessories & Gifts -- <http://www.laurelhome.com>

HOME IMPROVEMENTS
Accent Remodeling 1 Inc www.accentremodeling.com

HOSPITAL SUPPLIES
Innovative Laboratory Acrylics www.htonline.com/ila
Hennells www.hennells.com

HYPOPNOSIS
Premier Hypnosis Center www.premierhypnosis.net

IDENTIFICATION & LAMINATION
Identification Lamination Products -- www.identlam.com

INSURANCE
J J O Connell & Assoc Inc www.oconnellinsurance.com

INVENTIONS/PRODUCTS DEVELOPED/PATENTS
Martec Products International www.martecmpi.com

LAWYERS
Nichols & Eberth PC www.michiganattorney.com

MANUFACTURER'S REPRESENTATIVES
Electronic Resources www.esirep.com

MORTGAGE COMPANIES
Mortgage Market www.interest.com/observer
Information Services www.spectrummortgage.com
Spectrum Mortgage -- www.spectrummortgage.com
Village Mortgage www.villagemortgage.com

MUSIC MEMORABILIA
Classic Audio Repro -- www.classicaudiorepro.com
Jeff's Records www.jeffsrecords.com

NURSING EDUCATION
Michigan League for Nursing <http://www.oeonline.com/mln>

NUTRITIONAL SUPPLEMENTS
Dawn VanAmberg Independent Distributor [relivonline.com/dvanamberg](http://www.relivonline.com/dvanamberg)

PARKS & RECREATION
Huron Clinton Metroparks www.metroparks.com

PARTY SUPPLIES
1 800 PARTYSHOP www.1800partyconsultant.com/8070

POOL SUPPLIES
Water Specialties www.htonline.com/waterspecialties

REAL ESTATE
REALnet <http://www.oeonline.com/realnet.html>
American Classic Realty <http://www.americanclassicrealty.com>
AMP Building www.ampbuilding.com
Birmingham Bloomfield Rochester South Oakland Association of Realtors www.justlisted.com
Century 21 Town & Country www.century21towncountry.com
Detroit Association of Realtors www.detroitassocofrealtors.com
Griffith Real Estate www.eraffrith.com
Hall & Hunter Realtors <http://www.oeonline.com/hallhunt>

Langard Realtors www.langard.com
Lillian Hoard [lillian@rmanual.com](http://www.lillian@rmanual.com)
Max Brook Inc www.maxbrook.com
Moceri Development www.moceri.com
Quality Real Estate www.qualityrealestate.com
Real Estate One www.realestateone.com
Sellers First Choice www.sellersfirst.com
Western Wayne Oakland County Association of Realtors® www.wvocar.com

REAL ESTATE AGENTS
Susan Doyle www.susandoyle.com
Fred Glaysheer <http://www.homeshypermart.net>
Sandy Smith www.sandysmith.com
Bob Taylor www.bobtaylor.com

REAL ESTATE APPRAISAL
BBR/COAR Appraisers Committee <http://www.justlisted.com/appraisal>

REAL ESTATE EDUCATION
Real Estate Alumni of Michigan www.ramadantage.org

RELOCATION
Conquest Corporation www.conquestcorp.com

REPRODUCTIVE HEALTH
Asghar Afsari M.D. www.gyndoc.com
Midwest Fertility and Sex Selection Center www.mfss.com

RESTAURANTS
Albans Restaurant -- www.albans.com

RETIREMENT COMMUNITIES
Presbyterian Villages of Michigan -- www.pvm.org
Woodhaven Retirement Community www.woodhavenretirement.com

SHOPPING
Birmingham Principal Shopping District <http://www.oeonline.com/birmingham>

SURPLUS FOAM
McCullough Corporation www.mcfsoam.com

SURPLUS PRODUCTS
McCullough Corporation -- www.mcsurplus.com

TOYS
Toy Wonders of the World www.toywonders.com

TRACTOR REPAIR
Magnetos -- www.htnews.com/magnetos

TRAVEL AGENCY
Cruise Selections Inc www.cruiseselections.com
Royal International Travel Service www.royalintl.com

WEB SITE DEVELOPMENT
Observer & Eccentric Newspapers [oeonline.com/webpgs/html](http://www.oeonline.com/webpgs/html)

WHOLISTIC WELLNESS
Roots and Branches www.reikiplace.com

WOMEN'S HEALTH
PMS Institute www.pmsinst.com

WOODWORKING
Art Squared www.artsquared.com

WORSHIP
First Presbyterian Church Birmingham <http://www.fpcbirmingham.org>
Rochester First Assembly Church www.rochesterfirst.org
Unity of Livonia -- <http://www.unityoflivonia.org>

YOUTH ATHLETICS
Westland Youth Athletic Association www.wyaa.org

Put your business On-Line!, call 1-800-989-4614

THE WEEK AHEAD

PREP FOOTBALL
Friday, Sept 14
 Borgess at St Clement 7 p m
 Stevenson at Farmington 7 p m
 Salem at John Glenn 7 p m
 Wayne at Woodhaven 7 p m
 Garden City at Wyandotte 7 p m
 Trenton at RU (Kraft) 7 p m
 Gib Carlson at Thurston 7 30 p m
 C ville at Hamtramck 7 30 p m
 W L Western at Churchill 7 30 p m
 Franklin at Northville 7 30 p m
 Harrison at Canton 7 30 p m
 N Farm at W L Central 7 30 p m
Saturday Sept 15
 Luth W sid at Cranbrook 1 p m
 Redford CC vs Det DePorres at McCabe Field 1 p m
 St Agatha vs Cardinal Mooney at RU s Kraft Field 7 p m
GIRLS BASKETBALL
Monday, Sept 10
 St Agatha at Immac Con 7 p m
Tuesday, Sept 11
 Zoe at Clarencville 6 30 p m
 Luth W sid at N B Huron 7 p m
 Ladywood at Flint Powers 7 p m
 Taylor Bapt at Ply Christian 7 p m
 Huron Valley at St Alphonsus 7 p m
 Churchill at Franklin 7 p m
 Dearborn at Stevenson 7 p m
 John Glenn at Adrian 7 p m
 Redford Union at Garden City 7 p m
 Tay Kennedy at Thurston 7 p m
 Harrison at Farmington 7 p m

Canton at A A Pioneer 7 p m
 Southgate at Salem 7 p m
Thursday Sept 13
 Redford Union at C ville 6 30 p m
 Ladywood at ND Prep 7 p m
 Riv Richard at Mercy 7 p m
 Sacred Heart at St Agatha 7 p m
 Churchill at Farmington 7 p m
 John Glenn at Franklin 7 p m
 W L Western at Stevenson 7 p m
 Northville at Salem 7 p m
 Garden City at Wayne 7 p m
 Thurston at Annapolis 7 p m
 N Farm at Lakeland 7 p m
 Harrison at Brighton 7 p m
 Canton at W L Central 7 p m
Friday Sept 14
 Huron Valley at Flint Valley 5 30 p m
(Tip-Off Classic at Lutheran North)
Saturday Sept 15
 Tip-Off Classic at Luth North TBA
 N Farm at R O Kimball 7 p m
PREP BOYS SOCCER
Monday, Sept 10
 N Farm at John Glenn 5 30 p m
 W L Western at Churchill 7 p m
 Franklin at W L Central 7 p m
 Stevenson at Farmington 7 p m
 Harrison at Northville 7 p m
 Salem vs Canton (CEP) 7 p m
Tuesday, Sept 11
 Redford CC vs UU Jesu t at Mies Field (Livonia) 4 p m
 Franklin Road at HVL 4 30 p m
 Farmington at N Farm 7 p m

Wednesday Sept 12
 Churchill at Stevenson 7 p m
 Northville at Franklin 7 p m
 John Glenn at Harrison 7 p m
 Canton at W L Western 7 p m
 W L Central at Salem 7 p m
 Wayne at Ypsilanti 7 p m
 Monroe at Garden City 7 p m
 Redford Union at Thurston 7 p m
Thursday Sept 13
 Luth N west at C ville 4 30 p m
Friday Sept 14
 Redford CC vs DeLaSalle at Mes Field (Livonia) 4 p m
 Huron Valley at Luth East 4 p m
 John Glenn at Wayne 4 p m
 Truman at Garden City 4 p m
 Greenhills at C ville 4 30 p m
 Luth W sid at Cranbrook 4 30 p m
 Franklin at Lansing CC 5 30 p m
 Redford Union at Hamson 5 30 p m
 N Farm at Waterford Mott 6 p m
Saturday, Sept 15
 Stevenson at Roch Adams 1 p m
BOYS CROSS COUNTRY
Thursday Sept 13
 Churchill at W L Western 4 p m
 Franklin vs Canton (Cass) 4 p m
 John Glenn vs Salem (Cass) 4 p m
 Stevenson vs N Farmington at Cass Benton Park 4 p m
Saturday Sept 15
 N B Huron Invitational at Willow Metropark 9 30 a m
 W L Western Invitational 10 a m

Holly Invitational at Sprngfield Oaks 12 15 p m
GIRLS CROSS COUNTRY
Thursday, Sept 13
 Churchill at W L Western 4 p m
 Franklin vs Canton (Cass) 4 p m
 John Glenn vs Salem (Cass) 4 p m
 Stevenson vs N Farmington at Cass Benton Park 4 p m
Saturday Sept 15
 N B Huron Invitational at Willow Metropark 9 30 a m
 W L Western Invitational 10 a m
GIRLS SWIMMING
Monday Sept 10
 Ladywood vs Bishop Foley at M H Lamphere 7 p m
Tuesday, Sept 11
 Belleville at John Glenn 6 p m
 Churchill at Novi 7 p m
 Franklin at Thurston 7 p m
Thursday Sept 13
 Allen Park at Wayne 7 p m
 Stevenson at Churchill 7 p m
 John Glenn at Franklin 7 p m
 Ladywood vs Monroe St Mary at Eastern Mich Univ 7 p m
Saturday, Sept 15
 W Bloomfield Invitational 9 a m
GIRLS TENNIS
Monday Sept 10
 Ladywood at Pinckney 4 p m
 Churchill at Canton 4 p m
 Salem at Franklin 4 p m
 John Glenn at Stevenson 4 p m
 Robichaud at Wayne 4 p m
Wednesday Sept 12
 Cabrini at Ladywood 4 p m

W L Western at Churchill 4 p m
 Franklin at W L Central 4 p m
 Stevenson at Farmington 4 p m
 N Farm at John Glenn 4 p m
 Wayne at Highland Park 4 p m
Thursday, Sept 13
 Dearborn at Ladywood 4 p m
Friday Sept 14
 Churchill at Stevenson 4 p m
 John Glenn at Harrison 4 p m
 Inkster at Wayne 4 p m
BOYS GOLF
Monday, Sept 10
 Wayne at Wyandotte 2 45 p m
 Redford CC vs Dearborn at Dearborn CC 4 p m
Tuesday Sept 11
 Redford CC vs Divine Child at Dearborn CC 4 p m
Wednesday Sept 12
 Wayne at Dearborn 2 45 p m
 Churchill vs Farmington at San Manno 3 p m
 Franklin vs Canton at Idyl Wyld 3 p m
 Stevenson vs Northville at Tanglewood 3 p m
 John Glenn vs W L Western at Fellows Creek 3 p m
Thursday, Sept 13
 Redford CC vs Brother Rice at Dearborn CC 4 p m
Friday Sept 14
 Wayne vs Garden City at Westland Municipal 2 45 p m
 Churchill vs Canton at Hilltop 3 p m
 Franklin vs Salem at Idyl Wyld 3 p m

MEN'S COLLEGE SOCCER
Wednesday, Sept 12
 Schoolcraft at Delta 4 p m
Friday, Sept 14
 Schoolcraft at Indiana Tech 5 p m
Saturday Sept 15
 Madonna at Fla Southern 7 p m
Sunday Sept 16
 Madonna at Rollins (Fla) 2 p m
WOMEN'S COLLEGE SOCCER
Friday Sept 14
 Madonna at Ind Wesleyan 4 30 p m
Saturday Sept 15
 CMU Club at Schoolcraft 1 p m
 Madonna vs Trnity int (Ill) at Indiana Wesleyan 2 p m
Sunday Sept 16
 Schoolcraft at Cincinnati St 1 p m
WOMEN'S COLLEGE VOLLEYBALL
Tuesday Sept 11
 Schoolcraft at Macomb 7 p m
 Madonna at Concordia 7 p m
Thursday Sept 13
 Schoolcraft at Henry Ford 7 p m
 UM Dearborn at Madonna 7 p m
Friday, Sept 14
 S craft at Mott Tourney TBA
Saturday Sept 15
 Siena Hts at Madonna noon
 S craft at Mott Tourney TBA
Thursday Sept 13
 Whalers at Windsor 7 30 p m
Wednesday, Sept 15
 Whalers vs Erie Otters at Computware Arena 7 30 p m
 TBA — time to be announced

CROSS COUNTRY RESULTS

WESTERN LAKES ACTIVITIES ASSOCIATION BOYS CROSS COUNTRY QUAD MEET
 Sept. 6 at Cass Benton Park

DUAL MEET SCORES
 Livonia Churchill 20 Farmington 37 Churchill 22 Livonia Stevenson 34 Churchill 21 Plymouth Canton 36 Stevenson 27 Canton 29 Livonia Stevenson 25 Farmington 31 Plymouth Canton 24 Farmington 31

Individual runners
 1 Ryan Gall (LC) 16 42
 2 Will Chapman (LC) 16 48
 3 Logan Schultz (LC) 16 58
 4 Matt Gillespie (LS) 17 04
 5 Steve Dehnen (PC) 17 13
 6 Chris Tobe (F) 17 22
 7 Brandon McClellan (PC) 17 30
 8 Chris Furlong (LS) 17 30
 9 Jean Harris (LC) 17 32
 10 Pat Pruitt (PC) 17 35
 11 Ryan Kiblawi (F) 17 36
 12 Kevin Heist (F) 17 38
 13 Doug Novack (LS) 17 39
 14 Sean O Halloran (LS) 17 40
 15 Matt Rymond (PC) 17 43
 16 Dan Gruska (LS) 17 44
 17 Tom Eason (F) 18 00
 18 Mandeep Sanghe (LC) 18 04
 19 Pat Case (LS) 18 31
 20 Kevin Kane (LC) 18 44
 21 Justin Brevic (LC) 18 46
 22 Ross O'Hara (PC) 18 54
 23 Tom Peszek (F) 18 58
 24 Steve Armstrong (LS) 19 02
 25 Lance Dawson (F) 19 06
 26 Steve Kress (PC) 19 24
 27 Steve Cady (LS) 19 31
 28 Manus Giller (LC) 19 32

WLAA QUAD MEET Sept. 6 at Central City Park

DUAL MEET SCORES
 North Farmington 15 Westland John Glenn 46 Walled Lake Western 15 John Glenn 40 Farmington Harrison 15 John Glenn 40 W L Western 18 Harrison 37 W L Western 21 N Farmington 36 N Farmington 26 Harrison 31

Individual finishers
 1 K Naughton (WLW) 16 36
 2 N Naughton (WLW) 17 12
 3 Brian Coats (FHH) 17 16
 4 Eugene Furman (NF) 17 22
 5 Kounovsky (WLW) 17 47
 6 Ben Ganon (NF) 17 50
 7 Donovan (WLW) 18 02
 8 Dan Carlson (NF) 18 12
 9 Cleland (WLW) 18 15
 10 Jeff Mataya (NF) 18 24
 11 John Keller (FH)

18 34 12 Elliott Marshall (FH) 18 37
 13 Dan Coats (FH) 18 43
 14 Greg Ardisana (FH) 18 50
 15 Budal (WLW) 18 53
 16 Wayne Wright (FH) 19 07
 17 Matt Drew (FH) 19 08
 18 Fleming (WLW) 19 26
 19 Nick Israel (FH) 19 27
 20 Steve Sargol (FH) 19 37
 21 Robert Mooney (NF) 19 38
 22 Chad Barrett (WJG) 19 41
 23 Dokshin (WLW) 19 42
 24 Aspinall (WLW) 19 48
 25 Glenn Legacki (NF) 19 59
 26 Fralick (WLW) 20 17
 27 Kameron Sleep (WJG) 20 19
 28 David Mayseless (NF) 20 24
 29 Steve Jacobs (WJG) 20 40
 30 Mike Wech (WJG) 22 21
 31 Justin Miller (WJG) 22 24
 32 Joe Giovanni (WJG) 22 28

WLAA QUAD MEET Sept. 6 at Cass Benton

DUAL MEET SCORES
 Plymouth Salem 27 Northville 28 Salem 28 Walled Lake Central 29 Salem 15 Livonia Franklin 50 Northville 15 Franklin 50 W L Central 15 Franklin 48 Northville 27 W L Central 30

Salem finishers
 1 Justin Hajduk 16 59
 5 James Leddy 17 50
 9 Randy Bearden 18 05
 11 Adam Warner 18 22
 14 Bill Stemmermann 18 58
 16 Mike Horgan 19 04
 19 Jason Poniatowski 19 22

Franklin finishers
 24 John Krca towich 19 29
 31 Ronnie Friend 20 27
 31 Keith Schoepke 20 43
 37 Tom Hocking 20 53
 39 Robby Mills 21 07
 40 Michael Elam 21 09

SKATING STATION
SIGN UP TODAY!
 Register for Fall Hockey Leagues
 All Ages • \$120 Per Person
 Includes 10 games, game jersey, all ref. fees, and a champion T-shirt.
"Back-to-School Blues" All Night Skate
 Sat., Oct. 13th • 7:30 p.m.-7 a.m.
 Call for more info 734-459-6401
 www.skatingstation2.com
 8611 Ronda Drive (off of Joy Road) in Canton

Free! Countertop Sensor Microwave*
 JE1860
Just \$129 Over-the-range Microwave*
 JYM 1441

Fall Homecrest CABINETS
Sale
 Cabinetry For Every Room On Sale Now With Your Choice Of Microwave*.
 *Minimum purchase of 10 kitchen or bath cabinets to qualify.
 Offer ends November 30, 2001.

Auburn Kitchen & Bath 1990 Star Batt Dr ~ Rochester Hills ~ 248-853-2773	Kitchen Top Shop 31150 W 8 Mile Rd ~ Farmington Hills ~ 248-477-1515	New Concept Kitchen & Bath Showroom 13245 Newburgh Rd ~ Livonia ~ 734-542-1900 or 888-7-DESIGN	N.A. Mans Kitchen & Bath Centers 41900 Ford Rd ~ Canton ~ 734-844-2679	Kitchen Concepts 923 E Eight Mile Rd ~ Ferndale ~ 248-336-6000
---	---	---	---	---

Reasonable Rates ATTORNEY
 • Divorce
 • Employment Law
 • Contract Dispute
 • Immigration Law
Law Office of Roger Rathl, P.C.
 North of 12 Mile off Telegraph Road Evening & Weekend appointments available
 (248) 538-9421 www.rogerathl.com

Delightful Dining Rooms
Fabulous FURNITURE 2001
 You can WIN A SHOPPING SPREE!
\$12,000 IN PRIZES!
 Watch for details!

Why He'll Pay Less For His Home Improvement Than You Will.

HOME EQUITY LINE OF CREDIT AS LOW AS 5.5% APR INTRODUCTORY 6.5% APR CURRENT RATE

With just one visit, he became a member at Credit Union ONE. That means he'll pay less interest on his home improvement loan than most people will. You see, Credit Union ONE members are also owners. So profits are returned to them in lower loan rates. Like this home equity line of credit, it allows you to borrow up to 100% of your home's value, with zero fees to pay. It's just one of the money saving perks you'll find here at Credit Union ONE. Join us, and the things you borrow or save for will suddenly cost less.

Call Toll Free 1-800-441-8999 Or Apply On Line at www.cuone.org

18 branch locations throughout Michigan

Credit Union ONE
 The ONE anyone can join.

Annual Percentage Rate Introductory rate effect vs through December 31 2001 on min min \$50 000 draw Subject to qualification. Quoted rates effect vs as of August 23 2001 Rates subject to change

Talkin' turkey 'bout these vultures

Thanks to a hot tip from naturalist Rick Smith, my wife and I got to watch some turkey vultures roosting for the night

It was around sunset, when the warm sun no longer creates updrafts, that we headed west on Five Mile Road out of Plymouth. As we approached the area where Rick had spotted the roost, several vultures were flying low to the tree tops.

They were easy to identify because of their size, a wingspan of almost six feet, black coloration, wings held in a flattened "V" shape and their tiny head. Seldom did they flap their wings, even when maneuvering to land in the trees.



TIM NOWICKI

But without the sun to warm the air and create rising thermals on which they could soar, they must touch down and rest for the night.

From the road, we watched several fly from the south toward the roost. It was obvious that this was a traditional site that local birds return to each night.

As long as nothing interferes with their roosting, most birds use the same roost night after night.

It appeared that arriving birds would circle the core area looking for a spot, or maybe they were waiting for those in the trees to settle down. Or, maybe they were a controller at the roost waving in circling flyers when the perches were clear?

By the time the sun had disappeared and darkness was setting in, all the birds were on the roost. Without the bright sky in the background it was difficult to see the profile of their bodies under the canopy. Drivers passing by would never be able to see them if they were unaware of where to look.

However, their roost site was strategically, or appropriately, placed near a land-fill, and just to add some ambiance to the site, there was a dead skunk on the road. What more could these carrion eaters want in a roost site?

After leaving the vulture roost we passed a lake on the way home and noticed a handful of great egrets on their roost. Though light was definitely dim at this time, the white feathers of these medium-sized birds was reflecting what light was still available.

They choose an old fallen tree along the shore of this lake. Though exposed on the lake side, if a predator did approach them, they would be able to easily escape out over the water.

Roosting in a group is advantageous. The more birds in the area, the more likely one will notice danger and alert the others, either directly, or indirectly. More birds on a roost means it is less likely that each bird would get caught.

In Pontiac, at M-59 and Telegraph roads is a roost of hundreds of starlings. They have chosen a large billboard sign to roost at. This particular sign is two-sided with an open space in between—that is where the birds perch. Before they settle for the night, they circle the billboard in black peristaltic waves.

Eventually, a "leader" directs them to the roost for the night.

It's difficult finding where birds roost for the night, after all they don't want to be detected during this potentially vulnerable time, so they hide very well.

Tangles of vines, dense evergreen trees, man-made enclosures and leafy trees are just some of the places birds are known to roost in.

Waterfowl often sleep on the water and take their chances with underwater predators.

Keep your eyes open, you may find a night roost, too.

(Livonia resident Tim Nowicki is a naturalist with Independence Oaks Park north of Clarkston in Oakland County. He can be reached at (248) 625-6473.)

Communing with nature at Fairlane

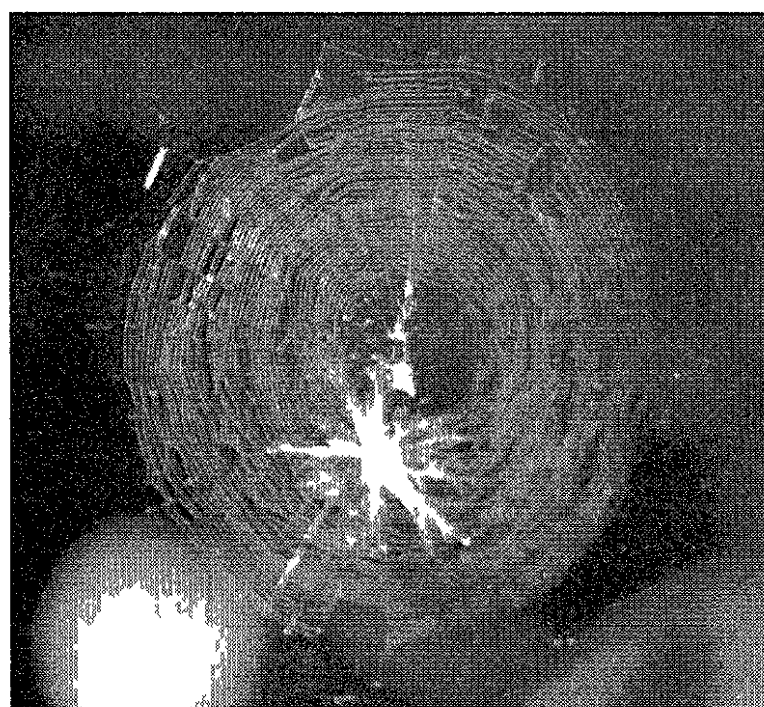
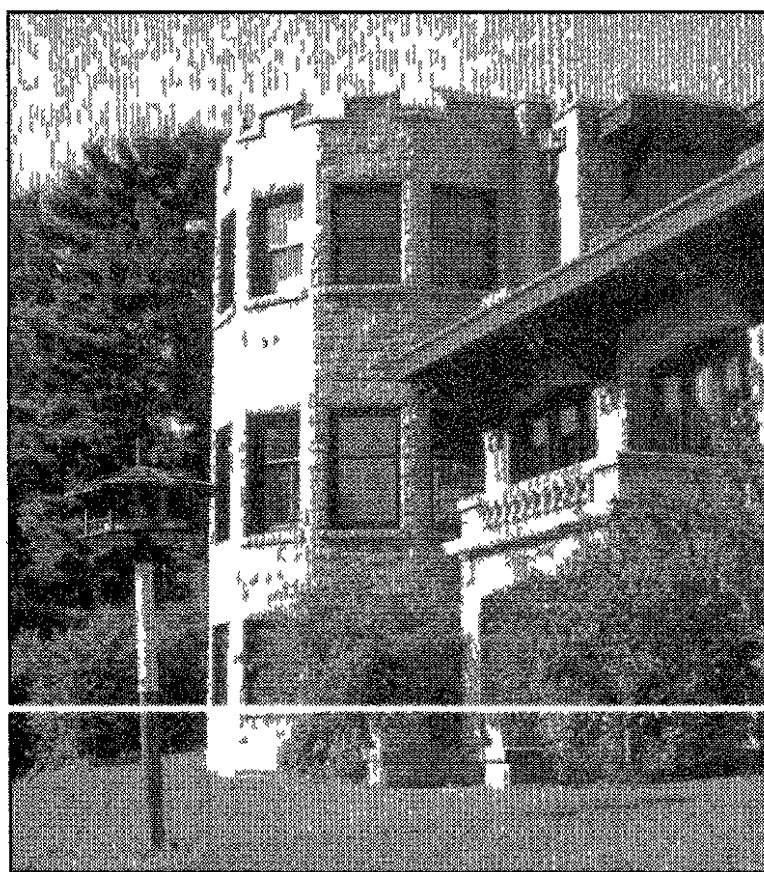

Nature: A trek through the grounds at Fair Lane in Dearborn reveal such treats as a spiral spider web (above), bees (top right), and a feeder sharing the grounds with Henry Ford's old mansion (Top left)

Right in our backyard is more wildlife than any of us might imagine. The banks of the Rouge River are home to a wide variety of plants and animals.

One great place to view wildlife is the University of Michigan Dearborn's new Environmental Interpretive Center. This is especially true for those who love birds and flowers.

The building itself is a new addition to a series of nature trails on property that once was part of Henry Ford's Fairlane Estate. It was built to resemble a bird in flight when seen from above. It includes three laboratory classrooms, an exhibit hall, and wildlife viewing areas.

Orn Gelderloos, Professor of Biology and Professor of Environmental Studies, hoped for a facility like this since he came to UM-D in 1969. Funding was made available by the state legislature, Wayne County, and the Ford Motor Company. Dr. Gelderloos credits the administration for making it all possible.

A variety of exhibits are being installed to teach visitors of all ages. Gelderloos believes it is important to have exhibits that are both entertaining and instructive.

"You can have lots of razzle-dazzle and not learn anything," he said. "Of course you have to have fun."

Exhibits will vary from high-tech electronics to low-tech. Eventually the Hines Park bicycle trail will be extended to the university so it will be possible for families to come by bike from as far as Northville.

Walking along the trails from the EIC to the Fairlane mansion it is possible to see animals like squirrels and groundhogs, but the real stars are the plants and birds. Now is the beginning of the fall wildflower season. Look for goldenrods and asters in the sunny areas. These plants bloom



JEFF MCGOWAN

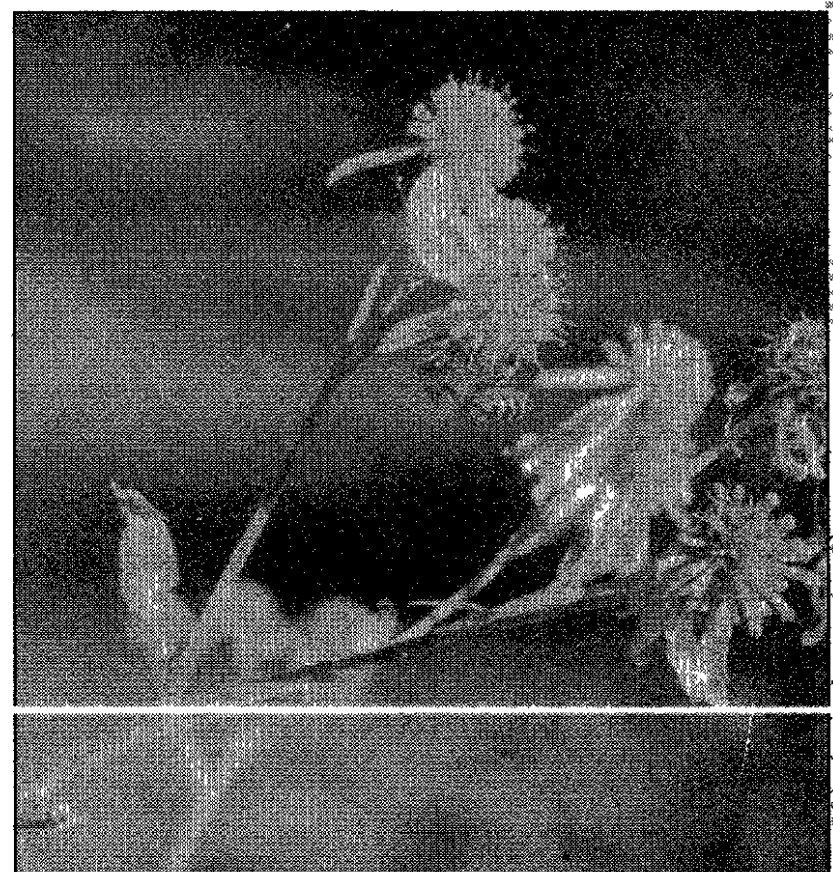

in response to the shorter days of autumn.

Stop and look very closely at the plants.

"The exciting thing about goldenrods and asters are the insects," said Gelderloos. They are home to soldier beetles, long-horned wood boring beetles, ladybugs, and wasps. The beetles, in turn, serve as food for dragonflies.

Also housed in the Environmental Interpretive Center is the Rouge River Bird Observatory. Each morning, birds are captured when they fly into fine "mist nets." Then they are weighed, banded, and released unharmed. Many birds are in the midst of their fall migrations. Twenty-six different species of migratory birds have been identified in the last several weeks.

Some birds come from as far north as the Arctic Circle. Bird watchers who wish to add to their life lists may want to visit

the 300-acre Environmental Study Area. Species identified this season include the black-and-white warbler, Philadelphia vireo, and rose-breasted grosbeak.

One of the more unusual finds was a Virginia warbler, which nests in the four corners area of the southwest United States. According to Gelderloos, this rare bird got blown over here by strong winds. "To get it in our nets is even more rare," he said.

The Environmental Interpretive Center is open from 10 a.m. to 5 p.m. each day.

The nature trails are open from sunrise to sunset. The best times for viewing wildlife are dawn and dusk. Schools, scout groups, or other organizations interested in the Center's educational programs should contact Rick Simek at 313-593-5338.

(Jeff McGowan is a freelance writer based in Garden City.)

OUTDOORS CALENDAR

ACTIVITIES/EVENTS

OAKLAND CO. SPORTFISHING ASSOCIATION

The Oakland County Sportfishing Association meets at 7:30 p.m. the third Wednesday of every month at Santa Hall, 1985 Cass Lake Road, Keego Harbor. Call (248) 693-4389 or visit the club's web site at <http://go.to/ocsa> for more information.

WESTBANK ANGLERS MICHIGAN

Westbank Anglers Michigan (6612 Telegraph Road) in Bloomfield Hills will host an event on Saturday Sept. 8 featuring Capt. Brian Meszaros and his secrets for successful flats fishing in Lake St. Clair. Meszaros will have a slide show at 1 p.m. followed by a seminar on all of the flies and tackle required. For more information, call (248) 538-3474.

KAYAKING

Eastern Mountain Sports and Heavener's Canoe Rental will host their fall kayak meeting on Wednesday Sept. 19 at 7:30 p.m. at Eastern Mountain Sports in Farmington Hills. The topic will be "Coping with changing weather." For more information, call (248) 932-5953.

DOWNRIVER BASS ASSOCIATION

The Downriver Bass Association, a non-tournament bass club, meets at 6:30 p.m. the fourth Tuesday of every month at the Gander Mountain (14100 Pardee Road) in Taylor. For more information, call Ron Fodor at (734) 676-2863 or send an e-mail to rivrerat122@home.com.

METRO-WEST STEELHEADERS

Metro West Steelheaders meets at 7:30 p.m. on the first Tuesday of each month in the cafeteria at Garden City High School. Call Dominic Laparoto at (248)

476-5027 for more information.

MICHIGAN FLY FISHING

The Michigan Fly Fishing Club meets at 7:30 p.m. the first and third Wednesdays of each month at Livonia Clarenceville Middle School, located on Middlebelt Road between Seven and Eight Mile roads. Visit www.mffc.org on the Internet for more information.

FOUR SEASONS

The Four Seasons Fishing Club meets 7:30-9:30 p.m. the first Wednesday of each month at the Livonia Civic Park Senior Center, 15218 Farmington Road. Call Jim Kudej at (734) 591-0843 for more information.

HURON VALLEY STEELHEADERS

The Huron Valley Steelheaders meets the third Thursday of each month at the Knights of Columbus Hall, 27600 Hall Road, Flat Rock. Call Carroll White at

(734) 285-0843 for more information.

SOLAR

The School for Outdoor Leadership, Adventure and Recreation (SOLAR), a non-profit organization interested in promoting the appreciation of outdoor activities, meets at 7:30 p.m. on the first Tuesday of each month at the Colony Hall in Southfield. Call (248) 988-6658 for more information.

CLINTON RIVER BASS 'N RATS

The recently organized Clinton River Bass 'n Rats meets the first Monday of every month at 7:30 p.m. at the Gander Mountain Lodge. Call (810) 247-9900 for direction and additional information.

(To submit items for consideration in the Observer & Eccentric's Outdoor Calendar send information to Outdoors, 805 E. Maple, Birmingham, MI 48009, fax information to 248-644-1314.)

Area centers spiff up for season

I have visited 93 bowling centers in and around the greater Detroit area in the past four weeks and spoken with proprietors, managers and people who work the counter.

They tell me the bowling is in great shape as we enter a brand new season.

Most places have upgraded facilities. Some have new ownership or management. Many have invested in new lane surfaces, going more to the synthetics.

A little paint or clean carpeting can go a long way toward making a place look spiffy.

The newest area bowling center is also the furthest away—the new Premier Lanes in Chesterfield Township managed by an old friend from Troy Lanes, Bonnie Hethcote.

The center has 34 bowling lanes, three movie theaters, a video room and the Foxchase restaurant. They are planning a similar center on our side of town.

Plaza Lanes in Plymouth has new owners in All-Star Steve Klein and Gerald Johnson at the helm. They bring some youth and energy into the picture, so watch them go at it with gusto.

Bel Aire Lanes in Farmington has new

ideas in place under the guidance of Mike Winkel, who is expanding his leagues and getting more young bowlers.

In nearby Romulus, the old Romulus Rec is going to be the new Romulus Rec with a new owner, George Forsey, who also brings youth and energy to the scene.

He has upgraded the restaurant with good food that attracts a nice lunch crowd from outside bowling.

Ford Lanes in Dearborn Heights has installed new synthetic lanes but left the approaches in with the original wood. We'll see how that works out.

Greg Siciha's Vision Lanes in Westland has a new pro shop with Mike Norris in charge. It is slated to open Sept. 14.

Colonial Lanes in Ann Arbor was visited on a Michigan football Saturday. Not so curiously, the parking lot was full.

Manager Frank Pepp says they charge seven dollars per car on that day for stadium parking, only a few blocks from the Big House. For those home dates, the parking lot may make more money than the bowling lanes.

Mark and Diane Voight of Farmington Hills have bought Woodhaven Lanes on I-75 and transformed it into a first-class operation.

Anyone wanting a personal score card to keep a record of yearly scores can find one on the counters of all local bowling

centers, courtesy of your Observer & Eccentric Newspapers.

•Tom and Kathie Parks moved away from Livonia several years ago after having bowled in the Men's and Ladies All-Stars for years.

Now they are moving to Canton and will resume local competition at the All-Star level.

They also have increased the size of their family with the birth of identical twin girls on July 20, 2001. The girls, Adrianna Moe and Kayleigh Suzanne, have the good genes to become great bowlers.

•With the new season upon us, who will be the first to bowl a 300 game?

At the moment, there are two perfectos reported by Westland Bowl on Tuesday Sept. 4. Both came in the Tuesday Men's League by Sam Fullerton and by Rob Lademan.

On the same night, Town 'n Country Lanes, also in Westland had one in its Tuesday Junior Classic League, by James Pierce.

There likely are more 300s by the time this goes to press, but these are the first ones we have been told about.

•The Pioneer Women's Club of Detroit announces its 53rd Annual Tournament to be held at 2:30 p.m. on Saturday, Nov. 3, at Thunderbird Lanes on Allen Road. Membership is open to women who have bowled 20 years or more.

To enter the bowling portion, you must be a DWBA sanctioned bowler and show your card.

Entry fee of \$11 is payable with the annual dues (\$2) and \$10 more for the dinner social. No entries accepted postmarked after closing date, Oct. 27, 2001. Entry forms available at most bowling centers.

•Mike Norris of Westland was winner of the August Michigan Majors championship at Galaxy Lanes in Grand Blanc. He was second-high qualifier so he had only one final match, in which he beat D.J. Hochstein for top honors.

D.J. did have a slight advantage—he's the owner of Galaxy Lanes.

For the match, Mike averaged 224.8 and took home a winner's check of \$1,000. Not a bad two-day's work.

As Norris will soon be opening the pro shop at Vision Lanes, he will have several innovative programs for all bowlers including a kids plan and his "Strike Club," a chance for people to get extra values in their purchases.

Every customer will get to bowl one game for evaluation before drilling, then another after drilling to make sure everything is just right.

(Al Harrison is a Garden City resident.)

TEN PIN ALLEY



AL HARRISON

SPORTS ROUNDUP

BASEBALL TRYOUTS

The Michigan Indians Travel Baseball Club will be holding individual tryouts for next year's 13 and under team. The highly competitive team is looking for pitchers and a shortstop. For more information call Mark Glover at 248-349-3392

LINE DRIVE HITTING CAMP

Total Baseball of Wixom, located at 30990 Wixom Road, will stage its annual line drive hitting camp from 9-11 a.m. (ages 7-12) and noon-2 p.m. (ages 13-19). Space is limited, so sign up early.

The skilled camp, directed by Michigan Baseball Coaches Hall of Fame member Lee Bjerke, will teach techniques in batting swing and bat speed. Fees are \$75 per player (\$10 off on each additional child). For more information, call (248) 668-0166 or email totalballwixom@aol.com to register.

LIVONIA Y HOOP LEAGUE

The Livonia Family Y is accepting registrations for its fall youth basketball league (ages 6 and up) beginning Oct. 20. For more information, call (734) 261-2161.

NEED GIRLS SOCCER PLAYERS

The Livonia Y Soccer Club is seeking girls with birthdates between July 31, 1992 through Aug. 1, 1990 for a complete recreational level soccer in the Western Suburban Soccer League. For more information, or to register, call (734) 261-2161, Ext. 3302.

YOUTH SOCCER LEAGUES

The Livonia Y is also accepting registrations for some age

groups (3 and up) for its youth soccer leagues, which start Sept. 8.

For more information, call (734) 261-2161, Ext. 3302.

The WaZa Developmental Soccer League for boys and girls ages 4-7 will begin Friday, Sept. 7 at Schoolcraft Community College.

The cost is \$100 for nine sessions (one hour each).

For more information, or to register, call (313) 937-6343 or (248) 477-1252.

INLINE HOCKEY LEAGUE

The Livonia Family Y is offering an inline hockey league (ages 6-13) from Sept. 10 through Oct. 10. Games will be scheduled outdoors (weather permitting).

Registrations are being accepted for all age groups.

For more information, call (734) 261-2161.

REFS, INSTRUCTORS WANTED

The Livonia Family YMCA, located at 14255 Stark Road, is currently hiring individuals 16 and older to fill the responsibilities of sports instructors and referees.

Positions are available for basketball, inline hockey, soccer, volleyball instructors and referees. Training is provided, but candidates must possess a strong, outgoing personality, a general knowledge of sports, and desire to work with youth.

Hours are primarily after school and weekends, with some daytime hours available. The YMCA offers competitive wages and free membership to employees.

Applications are available at the front desk or to schedule and interview, call (734) 261-2161.

Ext. 3325, or email evsey@ymcamedetroit.org

YOUTH BASEBALL TRYOUTS

Livonia Travel will be scheduling tryouts for next season's 12-year-old team. Many positions are available.

To schedule a tryout, call Bill Lems at (734) 261-4712.

Tryouts for a newly-formed Michigan Indians 12-and-under travel baseball team will be held at 1 p.m. Sunday, Sept. 9 at Massey Field in Plymouth.

The season will consist of approximately 50 games including the Little Caesars League, and tournaments. The Indians will also be representing the community in a tournament in Cooperstown, N.Y.

For more information, call Ben Kosmiski at (734) 416-1151 or email Bob_Cleary@rclearly79@mediaone.net.

Tryouts for the 13-year-old Michigan Lake Area Rams baseball team will be Sunday, Sept. 9, 16 and 23.

For more information, call Mark Falvo at (313) 537-3449 or Jack Falvo (248) 471-1748.

For more information about the WaCo Wolves' 2001 10-year-old travel baseball tryouts, call Tim Broughton at (734) 953-0786.

For WaCo Wolves 13-year-old tryouts, call Bill Hardin at (734) 516-3723.

The Michigan Rattlers are scheduling fall baseball tryouts for its 13-year-old travel baseball team for the 2002 season. The season consists of league, tournament and national play, running about 65 games.

Interested players and parents should call Jim Martin at (248) 477-9830.

WHALERS TICKETS

Individual game tickets for the Plymouth Whalers are now on sale at the Compuware Sports Arena box office. They may be purchased by calling (734) 453-8400 or by logging on to www.plymouthwhalers.com.

Ticket prices will remain the same for the third-straight year, with executive reserved seats at \$8 each and VIP tickets at \$12 each. The Whalers also offer a special Family Value Pack for certain games. The Family Value Pack includes four executive reserved tickets, four hot dogs, four soft drinks and two game programs for \$36.

The Whalers play most of their home games on Friday and Saturday nights, with the home season-opener scheduled for 7:30 p.m. Saturday, Sept. 15 vs the Erie Otters. Fans can come early for a pre-game celebration featuring Nickelodeon characters Angelica and Rocco, from Rugrats. Joining them will be Whalers' mascot Shooter, Lovely the Clown and Balloon Man Dan.

Pre-game festivities start at 6:00 p.m.

MOTOR CITY VOLLEYBALL

The Motor City Volleyball Club is running a fall training season from 6:30-9:30 p.m. Sept. 9 through Nov. 11 at Henry Ford Community College.

The cost is \$325. For more information, call Larry Wyatt at (734) 522-1680.

SOCCER SHOOT EVENT

The Livonia Parks and Recreation Department and the Livonia Elks Lodge will hold a Soccer Shoot Competition for youngsters 8-13 at 6 p.m., Wednesday, Sept. 12 at Bicentennial Park.

Winners from the competition, on fields 3 and 4 in back of the park, advance to the state contest in Big Rapids on Saturday, Oct. 13.

Boys and girls competition will be held in three age divisions, 8-9, 10-11 and 12-13. Ages are as of Aug. 1, 2001.

Registration is day of the event only.

The 8-9 age group gets three kicks at each of five variously sized goals while the other two age categories get 15 shots with points scored for hitting various sectors of the net.

For more information, call (734) 466-2410.

MOTOR CITY VOLLEYBALL

The Motor City Volleyball Club is running a fall training season from 6:30-9:30 p.m. Sept. 9 through Nov. 11 at Henry Ford Community College.

The cost is \$325. For more information, call Larry Wyatt at (734) 522-1680.

ADULT HOCKEY LEAGUES

Registrations are now being taken for the Fall and Winter Adult Hockey Leagues playing in the Plymouth Cultural Center, the Arctic Pond and the new Canton Ice Arena.

Leagues will be for over-21, over-30, over-40 and over-50 and will play from September

through March. Games will be played in the evenings.

For registration forms, see the web site at www.rspi.net.

Call John Wilson at (248) 471-0658 with questions or email him at john@rspi.net, or call the Arctic Pond at (734) 207-7663.

The Retirees' Hockey league for over-50 players is resuming drop-in play at the Arctic Pond Ice Arena in Plymouth. Cost is \$11 per game with play scheduled for 9 a.m. Tuesday and Friday mornings.

All Senior players are welcome. Free coffee and doughnuts are provided after the games.

Call John Wilson at (248) 471-0658 with questions or email him at john@rspi.net, or call the Arctic Pond at (734) 207-7663.

WOMEN'S SOCCER

The Canton Soccer Club and the Great Lakes Women's Soccer League are teaming up to form an eight-week recreational soccer league this fall.

All games will be played at 5 p.m. Sundays at Independence Park in Canton, beginning Sept. 9.

If interested, contact Becky Widlak at (734) 737-0137 or register on-line at www.GLWSL.com.

To submit items to the Sports Scene, write 36251 Schoolcraft Rd., Livonia, MI 48150, or send via fax to (734) 591-7279.

PLYMOUTH DISTRICT LIBRARY PUBLIC NOTICE

The Plymouth District Library Board will hold its REGULAR September meeting Tuesday, September 18, 2001 at 7:30 p.m. at 223 S. Main Street, Plymouth, Michigan 48170.

The Plymouth District Library will provide necessary reasonable auxiliary aids and services, such as signers for the hearing impaired and audio tape of printed materials being considered at the meeting, to individuals with disabilities at the meeting/hearing upon seven (7) days notice to the Plymouth District Library. Individuals with disabilities requiring auxiliary aids or services should contact the Plymouth District Library by writing or calling the following:

Barbara Kraft, Library Secretary
Plymouth District Library
223 S. Main Street
Plymouth, MI 48170
734-453-0750
X217

Publsh. September 9, 2001

L102068

CITY OF PLYMOUTH ORDINANCE NO. 2001-11

AN ORDINANCE TO AMEND CHAPTER 18, BUILDING AND BUILDING REGULATIONS, IN THE CODE OF ORDINANCES OF THE CITY OF PLYMOUTH FOR THE PURPOSE OF AMENDING ARTICLE XIII, KELLOGG PARK HISTORIC DISTRICT BOUNDARIES.

Section 1. The City of Plymouth ordains:
Article XIII, "KELLOGG PARK HISTORIC DISTRICT" in the Code of Ordinances of the City of Plymouth is hereby amended by modifying Section 18-639 and adding the following described text revisions.

Section 2. Modify Boundaries of District
Sec. 18-639. Boundaries of District
(deleted text shown as strike-through new text shown underlined in bold.)

(1) In Assessor's Plymouth Plat No. 8 Beginning at the southwest corner of Lot 216a thence northerly along the west line of Lot 216a to the northwest corner of said lot, thence easterly along the north line of Lots 216a, 215, 214 and 213 to the northeast corner of Lot 213, thence northerly along the west line of Lot 212 to the northeast corner of said lot, thence southeasterly along the north line of Lot 212 to the northeast corner of said lot, thence northerly across the Fralick Street right-of-way to the southwest corner of Lot 199, thence northerly along the west line of Lots 199, 198 and 197 to the northwest corner of Lot 197, thence easterly along the north line of Lot 197 to the southwest corner of Lot 196, thence northerly along the west line of Lots 196, 195, 194, 193 and 192a to the northwest corner of Lot 192a, thence northerly across Church Street right-of-way to a part of the northeasterly public park and the adjoining 1/4 of vacated Church Street on the north thereof "Assessor's Plymouth Plat No. 8" of part of the southwest 1/4 of section 26, part of the southeast 1/4 of section 27 and all of "Ella Safford's Subdivision" of part of said section 26 & 27, Town 1 South, Range 8 east, Plymouth Village (now city), Wayne County, Michigan, as recorded in Liber 64 of plats on Page 78, Wayne County Records, more particularly described as beginning at a point on the east & west 1/4 line of section 26 and the centerline of vacated Church Street distant south 88°11'00" west 41.17 feet from the intersection of the centerline of vacated Church Street with the centerline of South Main Street and proceeding thence along the northwesterly line of South Main Street south 34°54'30" west 251.47 feet; thence north 54°21'58" west 168.20 feet; thence along the westerly face of a stone wall along a curve concave to the east, radius 22.05 feet, central angle 93°22'28", chord bears north 07°37'15" west 32.11 feet, an arc distance of 35.87 feet; thence along the northwesterly face of said stone wall along a curve concave to the southeast, radius 167.50 feet, central angle 34°25'47", chord bears north 56°20'23" east 65.63 feet, an arc distance of 64.50 feet; thence along the northwesterly face of said stone wall north 73°33'16" east 58.55 feet; thence north 13°22'00" east 19.65 feet; thence along the east & west 1/4 line of section 26 and the centerline of vacated Church Street north 88°11'00" east 171.29 feet to the point of beginning, containing 0.7253 acres, subject to the rights of the public and of any governmental unit in any part thereof used, taken or deeded for street, road or highway purposes, subject to easements and restrictions of record thence southeasterly along the north line of Lot 192a to the northeast corner of said lot thence easterly across the Main Street right-of-way to the northwest corner of Lot 262a, Assessor's Plymouth Plat No. 9.

Section 3. Code Index (Modify as Required)

Section 4. Rights and Duties
Rights and duties which have matured, penalties which have incurred, proceedings which have begun and prosecution for violations of law occurring before the effective date of this ordinance are not affected or abated by this ordinance.

Section 5. Validity.
Should any section, clause or paragraph of this ordinance be declared by a Court of competent jurisdiction to be invalid, the same will not affect the validity of the ordinance as a whole or part thereof, other than the part declared invalid.

Section 6. Ordinances Repealed.
All other ordinances inconsistent with the provisions of this ordinance are to the extent of such inconsistencies hereby repealed.

Section 7. Effective Date
This ordinance shall become effective one day after publication.

DAVID McDONALD Mayor
LINDA LANGMESSER, City Clerk

Introduced September 4, 2001
Enacted September 4, 2001
Effective September 10, 2001
Publish September 9, 2001

B107946

PLANNING COMMISSION NOTICE CITY OF PLYMOUTH, MICHIGAN WEDNESDAY, SEPTEMBER 12, 2001 7:00 PM

A regular meeting of the Planning Commission will be held on Wednesday September 12, 2001 at 7:00 PM, in the Commission Chambers of the City Hall to consider the following:

PUBLIC HEARING

Proposed rezoning of various properties north of Ann Arbor Trail, Legal Description

The property to be considered for rezoning is situated in the area bounded by Ann Arbor Trail on the south, 150 feet west of Harvey Street on the west, 150 feet north of Church Street on the north and the CSX Railroad on the east. More particularly described as the following properties:

Number	Street	Property Number	Existing Zoning	Proposed Zoning
151	ADAMS	005 10 0088 000	RM 1	R 1
234	W ANN ARBOR TRAIL	006 07 0702 000	RM 2	RM 1
246	W ANN ARBOR TRAIL	006 07 0701 001	RM 2	RM 1
250	W ANN ARBOR TRAIL	006 07 0701 002	RM 2	RM 1
264	W ANN ARBOR TRAIL	006 07 0700 000	RM 2	RM 1
288	W ANN ARBOR TRAIL	006 07 0699 000	RM 2	RM 1
294	W ANN ARBOR TRAIL	006 07 0698 000	RM 2	RM 1
304	W ANN ARBOR TRAIL	006 07 0697 001	RM 2	RM 1
314	W ANN ARBOR TRAIL	006 07 0696 001	RM 2	RM 1
316	W ANN ARBOR TRAIL	006 17 0003 000	RM 2	RM 1
318	W ANN ARBOR TRAIL	006 17 0002 000	RM 2	RM 1
320	W ANN ARBOR TRAIL	006 17 0001 000	RM 2	RM 1
350	W ANN ARBOR TRAIL	006 17 0029 000	RM 2	RM 1
352	W ANN ARBOR TRAIL	006 17 0030 000	RM 2	RM 1
354	W ANN ARBOR TRAIL	006 17 0031 000	RM 2	RM 1
356	W ANN ARBOR TRAIL	006 07 0691 001	RM 2	RM 1
366	W ANN ARBOR TRAIL	006 07 0696 001	RM 2	RM-1
390	W ANN ARBOR TRAIL	006 18 0005 000	RM 2	RM 1
392	W ANN ARBOR TRAIL	006 18 0004 000	RM 2	RM 1
394	W ANN ARBOR TRAIL	006 18 0003 000	RM 2	RM 1
396	W ANN ARBOR TRAIL	006 18 0002 000	RM 2	RM 1
398	W ANN ARBOR TRAIL	006 18 0001 000	RM 2	RM 1
300	ANN ARBOR TRAIL CT	006 17 0007 000	RM 2	RM 1
304	ANN ARBOR TRAIL CT	006 17 0008 000	RM 2	RM 1
308	ANN ARBOR TRAIL CT	006 17 0009 000	RM 2	RM 1
310	ANN ARBOR TRAIL CT	006 17 0010 000	RM 2	RM 1
312	ANN ARBOR TRAIL CT	006 17 0011 000	RM 2	RM 1
321	ANN ARBOR TRAIL CT	006 17 0006 000	RM 2	RM 1
322	ANN ARBOR TRAIL CT	006 17 0012 000	RM 2	RM 1
323	ANN ARBOR TRAIL CT	006 17 0005 000	RM 2	RM 1
324	ANN ARBOR TRAIL CT	006 17 0013 000	RM 2	RM 1
325	ANN ARBOR TRAIL CT	006 17 0004 000	RM 2	RM 1
328	ANN ARBOR TRAIL CT	006 17 0014 000	RM 2	RM 1
332	ANN ARBOR TRAIL CT	006 17 0015 000	RM 2	RM-1
336	ANN ARBOR TRAIL CT	006 17 0016 000	RM 2	RM 1
340	ANN ARBOR TRAIL CT	006 17 0017 000	RM 2	RM 1
341	ANN ARBOR TRAIL CT	006 17 0028 000	RM 2	RM 1
344	ANN ARBOR TRAIL CT	006 17 0018 000	RM 2	RM 1
345	ANN ARBOR TRAIL CT	006 17 0027 000	RM 2	RM 1
347	ANN ARBOR TRAIL CT	006 17 0026 000	RM 2	RM 1
348	ANN ARBOR TRAIL CT	006 17 0019 000	RM 2	RM 1
349	ANN ARBOR TRAIL CT	006 17 0025 000	RM 2	RM 1
352	ANN ARBOR TRAIL CT	006 17 0020 000	RM 2	RM 1
355	ANN ARBOR TRAIL CT	006 17 0021 000	RM 2	RM-1
360	ANN ARBOR TRAIL CT	006 17 0022 000	RM 2	RM 1
364	ANN ARBOR TRAIL CT	006 17 0023 000	RM 2	RM 1
368	ANN ARBOR TRAIL CT	006 17 0024 000	RM 2	RM 1
708	CHURCH	005 10 0087 000	RM 1	R 1
808	CHURCH	008 06 0015 000	RM 1	R-1
834	CHURCH	008 06 0014 000	RM 1	R 1
897	CHURCH	006 02 0180 000	RM 1	R 1
854	CHURCH	008 06 0013 000	RM 1	R-1
210	ELIZABETH	006 07 0679 004	RM 2	RM 1
219	ELIZABETH	006 05 0007 000	RM 2	RM 1
239	ELIZABETH	006 05 0006 000	RM 2	RM 1
242	ELIZABETH	006 05 0009 000	RM 2	RM 1
259	ELIZABETH	006 05 0005 000	RM 2	RM 1
260	ELIZABETH	006 05 0010 000	RM 2	RM 1
299	ELIZABETH	006 05 0003 000	RM 2	RM 1
301	ELIZABETH	006 05 0002 000	B 2	RM-1
136	HAMILTON	006 07 0663 001	RM 2	R-1
148	HAMILTON	006 07 0665 000	RM 2	R-1
158	HAMILTON	006 07 0666 000	RM 2	R-1
168	HAMILTON	006 07 0667 000	RM 2	R 1
174	HAMILTON	006 07 0668 000	RM 2	R 1
180	HAMILTON	006 07 0669 001	RM 2	R 1
189	HAMILTON	006 08 0006 000	RM 2	R-1
190	HAMILTON	006 07 0670 000	RM 2	R-1
193	HAMILTON	006 08 0005 000	RM 2	R 1
196	HAMILTON	006 07 0671 000	RM 2	R 1
199	HAMILTON	006 08 0004 000	RM 2	R 1
217	HAMILTON	006 08 0003 000	RM 2	R-1
239	HAMILTON	006 08 0002 000	RM 2	R-1
257	HAMILTON	006 08 0001 000	RM 2	R-1
281	HAMILTON	006 07 0686 000	RM 2	R 1
311	HAMILTON	006 07 0687 000	RM 2	R 1
381	HAMILTON	006 18 0006 000	RM 2	RM 1
383	HAMILTON	006 18 0007 000	RM 2	RM-1
385	HAMILTON	006 18 0008 000	RM 2	RM 1
387	HAMILTON	006 18 0009 000	RM 2	RM 1
389	HAMILTON	006 18 0010 000	RM 2	RM 1

Number	Street	Property Number	Existing Zoning	Proposed Zoning
112	N HARVEY	005 10 0085 000	RM 1	R-1
122	N HARVEY	005 10 0084 000	RM 1	R-1
156	N HARVEY	005 11 0082 000	R-1	

Art from page C1

event”
Sara Frank likes exhibiting in the show because it's easier to browse through the 125 booths. Frank, a West Bloomfield artist, will bring tiles with themes ranging from insects, women and nursery rhymes to music, also mirrors with tile borders and tables with tile tops.

This is Frank's third year in the festival, and one of just six shows she will do in 2001. Most of her work comes from commissions for custom backslashes and fireplaces.

“The Detroit Festival of the Arts is small enough that people can see the art section without difficulty,” said Frank, who took her first ceramics class at Pewabic Pottery in 1995. “I personally enjoy the street performers. Last year they had life-size Slinky. I'm looking forward to seeing what they have this year.”

But the festivities don't end with the festival's programming. The International Institute is holding its 75th World Market at 111 East Kirby across from the Detroit Institute of Arts. Continuous folk dance performances, ethnic food, arts and crafts, and children's activities will introduce visitors to cultures from as far away as Ukraine, Greece and Scotland.

The World Market originated after immigrants, who came to Detroit to work in the factories, lost their jobs during the Depression. To help out, the women of the families brought treasured heirlooms, needlework, wood-carvings, jams and jellies to the International Institute to sell. Every year since then, the “American” community is invited to not only buy goods in the Institute's International Gift Shop but enjoy songs and dance from around the world.

“It's a chance to explain the importance of immigrants and to show we're all from one world,” said board member Eva Boicourt of West Bloomfield.

For more information about the International Institute's World Market call (313) 871-8600.

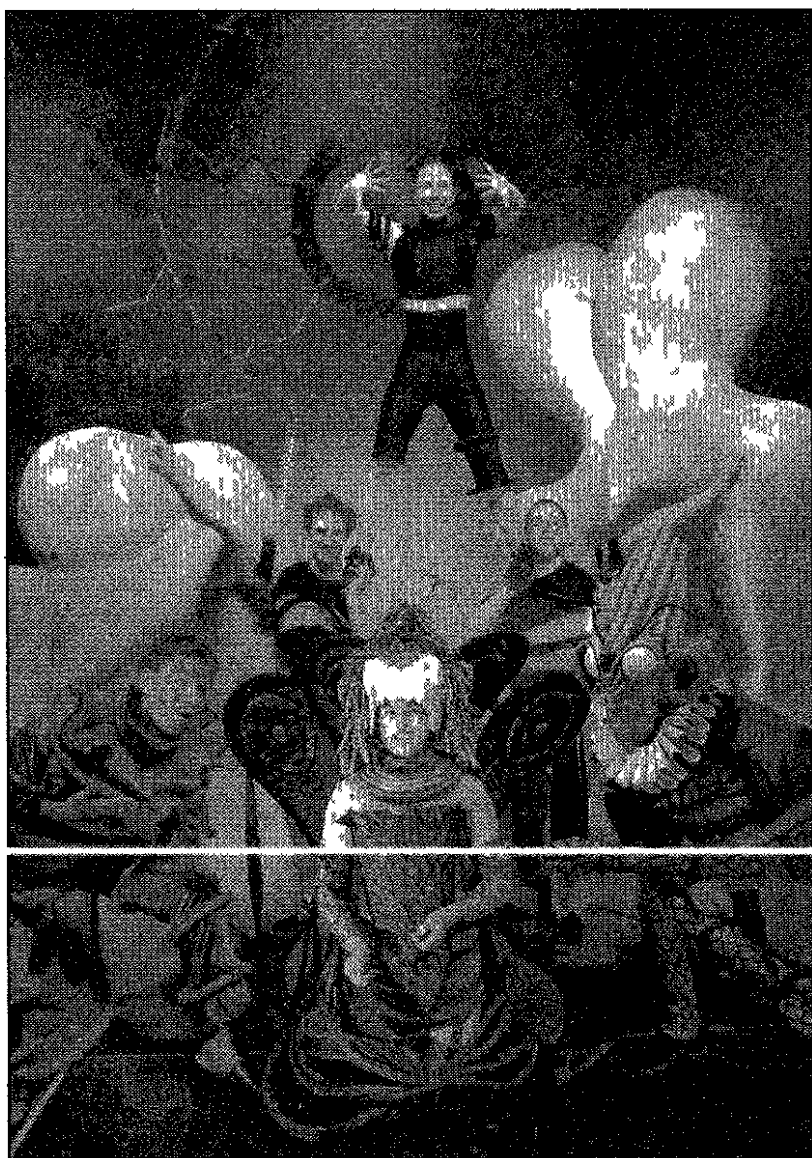

Shakespeare revisited: *Repercussion Theatre* returns to the festival with a new twist on Shakespeare's “*Twelfth Night*” 9 p.m. Friday-Saturday on the north lawn of the Detroit Institute of Arts.



Children's fair: Activities, provided by 60 organizations will keep kids busy at the Detroit Festival of the Arts.

DSO from page C1

what's happening. When I was in college you could hardly find a recording of the bass.”

Stephen Edwards is just as excited about Meyer's performance as Hutchinson because he thinks of Meyer as the “Michael Jordan of the double bass.” Still Edwards can't wait for his first rehearsal with Perlman.

“You know – he's Itzhak Perlman so when he suggests to a string player to do something you believe him,” said Edwards, a Beverly Hills resident who joined the DSO in 1972. “Anything he asks you to do, you know he can do. He has a wonderful ear in terms of color and taste. The opening concerts are going to be exciting. It's a blessing that he was able to fill in for Neeme.”

John MacAlwee couldn't agree more.

“It's very exciting because we're into the Perlman season,” said MacAlwee, vice president of marketing and communications. “We've been talking about this for a long time. It's nice when it finally arrives, but there's so many different concerts it's hard to pick a favorite. There's repertoire we haven't done in a while, *The Planets* by Holst, and recent work (*UFO*) by composer-in-residence Michael Daugherty. We have guest artists like Evelyn Glennie, one of the greatest percussionists in the world. She's hearing impaired and feels the music through her feet.”

■ ‘We have a lot of very good music scheduled. I personally love Stravinsky – all three ballets. We're going to miss Neeme but I'm quite pleased to be working with Perlman. It's a bonus.’

*Violinist Cathy Compton
Speaking of Itzhak Perlman*

“And it's nice to have Gunther Herbig return (Herbig conducted the DSO 1984-1990). We also have our pop series, a super jazz fall with Cassandra Wilson, the Afro-Cuban All Stars, and Herbie Hancock celebrating the 75th birthdays of John Coltrane and Miles Davis, and a fun concert with The Klezmatics (Oct. 13). Klezmer music is so popular all over the world. The concert is presented in partnership with the Jewish Community Center in West Bloomfield.”

MacAlwee could go on and on about the new season.

“We're doing three of Stravinsky's ballets *Rite of Spring* is one of the most important musical works of the 20th century. *Firebird* is always a favorite and shows the development of Stravinsky, and *Petrouchka*,” continued MacAlwee. “This is the third year of our Introduction to the Classics series with Tom Wilkins. It grows substantially every year. It's a great way for people not familiar with classical music and a lot of classical music enthusiasts to become

familiar with the music because the conductor talks about the piece.”

Violist Cathy Compton thinks “every concert has something for everyone.” She is most excited about playing the world premiere of *Episodes for Orchestra* by African-American composer Olly Wilson Feb. 1-3. Compton studied sight reading with Wilson at Oberlin Conservatory of Music.

“We have a lot of very good music scheduled,” said Compton, a Pleasant Ridge resident entering her 28th season with the DSO. “I personally love Stravinsky – all three ballets. We're going to miss Neeme but I'm quite pleased to be working with Perlman. It's a bonus. He's thrilled to be conducting pieces that are not violin concertos. You can see the pleasure in his eyes to be changing his repertoire. But since he's such a fine musician, anything he does is fine with me.”

Expressions from page C1

to Lin Baum show students the finer points of everything from figure drawing to portraiture. Jim Riopelle will demonstrate painting outdoors at an easel. Capture the spectacular fall color in Canton 10 a.m. to 3 p.m. Saturday, Sept. 29. Maps will be sent upon registration. The cost is \$30. VAAL members, \$35. Non-members VAAL offers reduced rates on all of its classes with a \$20 membership.

Looking for a challenge? Gladys Beall teaches a workshop on painting fall flowers on Yupo paper Saturday/Sunday Sept. 22-23.

“Yupo paper is a plastic,” said

Adams. “It really loosens up watercolorists because you have almost no control.”

To register, call Adams at (734) 455-9517.

D & M Studios

Donna Knight expects D & M Studios new home school classes on Monday to be a hit with kids and parents. The classes previously had been held on Friday only. They will be taught by Sharon Dillenbeck, Canton artist and studio owner.

“When kids come back from summer break they're so excited their faces light up,” said

Knight. “Sharon has new and innovative ideas for the preschool classes, but we have classes for ages 3 to 103 plus workshops for the Christmas holidays, an all-day paint workshop Nov. 23, and a Christmas card workshop. We also are carrying a bigger selection of art supplies including paint by number kits.”

For information, call (734) 453-3710.

Have an interesting idea for a story? Call arts reporter Linda Ann Chomin at (734) 953-2145 or send e-mail to lchomin@oehomecomm.net.

Hot Off Its Sold-Out Run in London's West End, the Wickedly Popular British Theatrical Sensation Comes to Ann Arbor!

SHOCKHEADED PETER
featuring the **TIGER LILLIES**

SEPTEMBER 12-15 Michigan Theater

The most imaginative, gruesomely enjoyable and award-winning show of the year. — DAILY MAIL

Combining the spirit of *The Rocky Horror Picture Show*, Tim Burton and the Grimm fairy tales, this hilariously gruesome “junk opera” stops in only three U.S. cities. Don't miss the event that is sure to have everyone talking!

Warning: May be too shockheaded for children under 9.

MEGAS SPONSORS
BORDERS **METRO TIMES**

ums Tickets: 734-764-2538 or visit www.ums.org

Crazy Al's Song Scramble

Unscramble the answer to the question, then listen Monday to Crazy Al's Radio Party at 8:00 A.M. to identify the backwards record. If you are correct you win a great prize!

Listen to Crazy Al's Radio Party WPON 1460 AM Mon.-Fri. 6:00 A.M. - 9:00 A.M. & 2:00 P.M.-4 P.M.
Call 248-332-1460

1. Lloyd Price had many hits, but only one reached the number 1 position and stayed there for 4 weeks back in May of 1959.

GSREGTA ELE

Crazy Al's Radio Party
Truly the greatest rock and roll show you've ever heard!
LISTEN TO RARE ROCK AND ROLL ON
WPON Radio Oldies 1460 AM
Oldies You Just Don't Hear Any Place Else!
Crazy Al's Radio Party Mon.-Fri. 6-9 a.m., afternoons 2-4 p.m.
LISTEN ON THE WEB www.wpon.com

Read HomeTown Life every Thursday

MESQUITE JUNCTION STEAKHOUSE

13800 Middlebelt • Livonia
734-762-4279

Voted People's Choice Winner! Taste of Livonia 2000

Come taste our great award winning **Steaks, Seafood & Ribs**

Under New Management
Open Mon-Thurs 11 am - 10 pm
Fri 11 am - 11 pm,
Sat 4 11 pm, Sun 2 - 9 pm

BIRMINGHAM BLOOMFIELD
ArtCenter
Fall Term 2001
SEPTEMBER 10-DECEMBER 8

It's time to nurture your creativity and take the art class you've been thinking about...

Art History	Metals	Watercolor
Auto Design	Mixed Media	Portfolio Prep
Calligraphy	Painting	Youth Ceramics
Ceramics	Pastels	Youth Drawing
Critiques	Photography	Youth Jewelry
Design	Polymer Clay	Youth Mixed Media
Drawing	Printmaking	Youth Painting
Fibers	Sculpture	Youth Photography
Jewelry	Art Trips & Tours	Adult & Child

Birmingham Bloomfield Art Center
1516 South Cranbrook Road
Birmingham, Michigan 48009
WWW.BBARTCENTER.ORG

Call to register now!
(248)644-0866

SPONSORED BY THE OBSERVER & ECCENTRIC NEWSPAPERS

MOSCOW STATE CIRCUS

October 26-28 On Sale Tomorrow 10 am

Friday, October 26 • 7:30 pm ALL TICKETS \$5!
Saturday, October 27 • 11 am, 3 pm & 7:30 pm
Sunday, October 28 • 1 pm & 5 pm

Tickets on sale at PalaceBoxOffice.com. The Palace Box Office and www.palaceboxoffice.com. Charge at (248) 645-6666. Discounts available for groups, kids and seniors. For more information call (248) 377-0100.

Noteworthy

Gallery exhibits, art shows, classical concerts

MAKING CONTACT: Please submit items for publication, at least two weeks in advance of the event, to Noteworthy, The Eccentric Newspapers, 805 E. Maple, Birmingham, MI 48009 or fax (248) 644-1314

ART SHOWS & FAIRS

ART ON CENTER
The galleries of downtown Douglas will be hosting this simultaneous art event Saturday Sept 15. The Nines Gallery 25 W Center in Holland, The Elephant's Trunk and The Lion House Studio 20 E Center Mixed Media 23 W Center Bud Baty Designs 32 E Center, and Luoma & Emily Art Gallery 202 W Center are participating (616)857 9997

ARTS & APPLES
This festival showcases more than 300 artists live entertainment and food for every taste at Rochester Municipal Park through Sunday Sept 9. Featuring the work of Rochester artist Rick Burger and chromogenic and silver gelatin prints by Barbara Abel (248)651 7418

BENEFITS

ART WORKS FOR LIFE
Silent and live auction of 150 pieces of original works by prominent area artists hosted by Midwest AIDS Prevention Project Saturday Sept 22. Complimentary hors d'oeuvres and wine tasting live music strolling fashion show and a tour of the Ford House featured. Reserve tickets by Sept 14 by calling Yvonne Greehouse at (248)545 1435 ext 13

DOWNRIVER COUNCIL FOR THE ARTS
The Home Gallery presents a fine-arts sale and exhibition through Sept 29 to support the Ashes to Action Fund which provides assistance to artists affected by the March 16 fire in Wyandotte. Artists wishing to participate in *Ashes + Action = Art* should call (734)287 6103

CALL FOR ARTISTS & AUDITIONS

COMMUNITY CHOIR
Schoolcraft College Community Choir is holding auditions Sept 11 in Room 310 of the campus Forum Building 18600 Haggerty Livonia. Call director Gerald Custer at (734)481 3453

CRAFTERS SOUGHT
Crafters are needed for the St Valentine Holiday Arts & Craft Shoppe on Saturday Nov 10 (313)255 6825

GENERAL MOTORS CHORUS
Accepting new members for the fall/Christmas season Sept 10 and 17th at 6:45 p.m. All new former and current members should report to the Lincoln High School chorus room at 22900 Federal Warren. The GEMEC is open to the public and participants must be 18 to join (810) 447 2319

HALLOWEEN HOCUS POCUS
Children ages 8-16 are invited to audition for Halloween Hocus Pocus at the Marquis Theatre 135 E Main Northville at 7 p.m. Sunday Sept 9 (248)349 8110

HOLIDAY ARTS & CRAFTS SHOW
Artists and crafters sought for this juried show at North Farmington High School Nov 17. No manufactured goods accepted. 32900 W 13 Mile Farmington Hills. Contact Dianne at (248)553-0913

HOLIDAY CRAFT FAIR
Crafters and artists are needed for this annual event held at the Auburn Hills Presbyterian Church Saturday Oct 13 3:56 PM Primary Street Auburn Hills (248)852 3889 or (248)299 3909

JACKSON CHORALE
Auditions for new members are at 8:30 p.m. Monday Sept 10. Open to men and women past high school age. Vocal Music Room Adams High School 3200 W Tienken Rochester Hills (248)651 3085

MICHIGAN CLASSIC BALLET
Auditions for the *Nutcracker* are Sept 9 (ages 6-9 12 p.m. ages 10-12 2:30 p.m. and 13 and up 3:40 p.m.) and Sept 12 (ages 10 and up 7:15 p.m.) at Geiger Classic Ballet Academy in Bloomfield Hills. Audition fee is \$15

VILLAGE MUSIC STUDIO
Rising Star Singers, community show-choir is auditioning youths ages 8-15 from 7:30 p.m. Tuesday Sept 18. Bring prepared song to sing, accompaniment provided. 130 E Liberty Plymouth. For more information call Norma Atwood at (734)354-9825

SINGERS SOUGHT
Farmington Community Chorus will hold new member auditions Tuesday Sept 11 beginning at 7:30 p.m. at the William Costick Activities Center on 11 Mile Road just east of Middlebelt in Farmington Hills. Contact Chorus Manager Kathy Hall at (248)471 4516

WRITERS CONFERENCE
Manuscripts and poetry will be accepted through Oct 5 for an individual critique at the 40th

Annual Writers Conference on the Oakland University campus near Rochester. Budding writers attending a Michigan college or university are invited to apply for a scholarship to attend the Oct 20 conference which offers an opportunity to learn from professional writers, agents and editors. Deadline for receipt of application materials is Sept 21 (248)370 3125

CLASSES

ART OF LIVING STUDIO
Offers classes in drawing scarf dyeing and awakening your artistic vision. Book conversation and poetry nights. 11 S Broadway Lake Orion (248)693 3632

ART MUSEUM PROJECT
Public non credit studio art classes and workshops are offered at the University of Michigan Dearborn 4901 Evergreen No 1165AB Dearborn (313)593 5058

BIRMINGHAM BLOOMFIELD ART CENTER
Fall course terms beginning Sept 10 through Dec 8 and includes All Levels of Drawing at the Museum Woodcut Printing and Creativity is Fun for preschool and kindergarten. 1516 S Cranbrook Birmingham (248)644-0866

COLLEGE FOR CREATIVE STUDIES
Accepting registrations for its fall continuing education classes which will begin in late September at the campus on Kirby and John R in Detroit and at the Civic Center in Novi. For a schedule or more information call (313)664-7456 or e-mail cce@ccsd.edu

PEWABIC POTTERY
Offering 12 week classes beginning Sept 10 in ceramics tile making wheel throwing salt firing. 10125 E Jefferson Detroit (313)822 0954

VISUAL ART ASSOCIATION OF LIVONIA
Classes in various arts forms at the Jefferson Center Room 16 9501 Henry Ruff Livonia. Call Mary Ann Adams at (734)455 9517

CONCERTS

COMCAST CONCERT SERIES
Comcast's Cool & Classy Concert Series begins 8 p.m. Sept 15 at the Detroit Opera House with the king of New York Cabaret Bobby Short special guest Jo Thompson and the JC Heard Orchestra. The series highlights pop jazz and cabaret's top performers. For tickets call (313)961 3500

DETROIT SYMPHONY ORCHESTRA
Detroit area singles can meet during a free classical music preview party 5:30-7:30 p.m. Monday Sept 10 at Mario's Restaurant 1477 John R in Troy. A classical series, *Brahms First* will be performed Sept 12 15 and 16 and an *Opening Gala Concert with Bernadette Peters* will be performed Sept 14. For tickets call (313)576 5111

ORCHARD LAKE SCHOOLS
Contemporary Japanese jazz pianist Keiko Matsui will highlight the sixth annual Jazz on the Lake Sunday Sept 9 on the campus of Orchard Lake Schools. Also starring Alexander Zojnic and Orchard Lake Schools student Angela Bofill. Located at Orchard Lake and Commerce roads in Orchard Lake (248)683 1750

DANCE

BALLET WORKSHOP
Suzanne Hawkins Ballet Workshop offers ballet classes for teens and adults in beginning through advanced levels on weekday mornings in Sterling Heights and Rochester. Also on Sunday mornings at 132 Varner Hall Oakland University Rochester campus (248)652 3003

DEBORAH CHASE SCHOOL OF DANCE
Accepting new students for a comprehensive program in dance art and musical theatre. 29820 Joy Livonia (734)513 2004 or 421 4212

DETROIT BALLET
Classes in child and adult classical ballet tap and jazz. Adult beginners welcomed. Classes offered at the Betty Johnston Dance Studio in Farmington Hills at Folsom and Nine Mile (248)474-3174

EISENHOWER DANCE ENSEMBLE
All levels of classes for recreational and professional students including modern ballet pointe tap and jazz for children ages 3 and older. 1541 W Hamlin between Crooks and Livernois Rochester Hills (248)852 5850

DEBBIE FELTON'S ACADEMY OF DANCE
Taking registrations for fall enrollment 16312 Middlebelt Livonia (734)524 0104

JEWISH COMMUNITY CENTER
Offering classes for preschool children at the Oak Park campus

15110 W Ten Mile (248)967 4030

METRO DANCE
Boys only classes in ballet tap and hip-hop. A pilates based conditioning class Tuesday evenings for ages 12 adult. Beginning through advanced adult tap and ballet adult jazz and hip-hop. Times and fee vary. 541 S Mill, Plymouth (734)207 8970

EVENTS

CHURCHILL HIGH
Accepting applications for the fall craft show Saturday Oct 20 8900 Newburgh Livonia (734)523 0022

CULTURAL ARTS AWARD
The sixth annual Birmingham Bloomfield Cultural Arts Award will be presented during the opening reception for the Annual Exhibition of the Birmingham Society of women painters 6:30 p.m. Sept 14 at the Birmingham Bloomfield Art Center 1516 Cranbrook Birmingham (248)644-0866

ART, MUSIC, FASHION AND FILM
Detroit Contemporary presents the premiere of its fourth season with an evening of art music fashion and film beginning at 5 p.m. Sept 15 with the opening reception for artists Mitch Cope Gerry Craig Sherry Gaines and Nelson Smith. Also features music performances a drive in theatre with live musical accompaniment and a strolling fashion show 5141 Rosa Parks, Detroit (313)898 4707

MEADOW BROOK HALL
Offers Dodge Brothers Motor Car Exhibition through Sept 30 and Tea on Tuesdays, the third Tuesday of each month, from 3 4:30 p.m. Reservations required (248)370-3140

ORIGINAL WORLD MARKET
The International Institute is celebrating its 75th Anniversary Original World Market Sept 14-16 featuring world class international performing groups arts and crafts booths ethnic foods children's activities craft demonstrations and exhibits and raffle and door prizes. Free admission 111 E Kirby Detroit (313)871 8600

FOR KIDS

BLUE LAKE FINE ARTS CAMP
Weekend camp for children 3-10 with Williams Syndrome Sept 14-16 300 E Crystal Lake Twin Lake (800)221 3796

VILLAGE MUSIC
Offers early childhood music classes for ages newborn to 8 years through the Kindermusik program 130 E Liberty Plymouth (734)354-9825

GALLERY EXHIBITS (OPENING)

AUCOURANT INTERIOR DESIGN STUDIO/GALLERY
Opens Sept 14 - *Split Self* a showing of the works of Lois Teicher nationally known Michigan artist on exhibit through Oct 19 23255 Woodward Ferndale (248)548 3770

CASS CAFE
Opens Sept 13 - *Deja Vu* an exhibition of recent work by Nancy Bonior Steve Foust Christine Hughes Germaine Keller Gary Mayer Kurt Novak and Ivy Rutzky which runs through November 4620 Cass Detroit and Grey Gallery 1 John R Sixth Floor Detroit (313)831 1400

DETROIT ARTISTS MARKET
Opens Sept 14 - Ritual featuring on site tattoo demonstration and more. Opening reception 7 10 p.m. Sept 14 4719 Woodward Detroit (313)832-8540

FARMINGTON ARTIST CLUB
Opens Sept 12 - B J Blackford works will be featured. Her great grandfather was Vincent van Gogh first cousin to the famous painter. Farmington Hills Library on 12 Mile Road next to post office (248)324 2525

HALSTED GALLERY
Opens Sept 13 - Photographs of Edward Curtis who captured the images of North American Indians from 1898-1920 runs through Nov 3 560 N Old Woodward Birmingham (248)644-8284

OAKLAND COUNTY GALLERY
Opens Sept 10 - *Hidden Talents Employee Art Show* runs through Nov 16 with an opening reception 5:30-8 p.m. Sept 10 Office of Arts Culture & Film in the Executive Office building 1200 N Telegraph Pontiac (248)858 0415

PEWABIC POTTERY
Opens Sept 14 - *Contemporary African American Ceramics and Incubation Series Part 4 Sarah Spencer White* runs through Oct 27. Opening receptions are 6:30 p.m. Sept 14. Meet artist Winnie

Owens Hart during an attending reception Sept 14 10125 E Jefferson, Detroit (313)822 0954

WAYNE STATE UNIVERSITY
Opens Sept 14 - *Up from the Streets Detroit Art from the Duffy Collection* is on display through Dec 21 in the Elaine L. Jacob and Community Arts galleries 480 W Hancock and 5400 Gullen Mall in Detroit (313)577 2423

GALLERY EXHIBITS (ON-GOING)

A.C.T. GALLERY
Through Oct 5 - *Photography Images from Six Detroit area Artists* 35 East Grand River Detroit (313)961-4336

ANN ARBOR ART CENTER
Through Oct 7 - *In Essence A Study in Abstract Art* featuring Michigan artists Karin Bodycombe Larry Cressman Richard Fairfield Barbara Costello and Karen Izenberg 117 W Liberty Ann Arbor (734)994-8004 ext 104

Through Oct 22 - Works of Ypsilanti artist Daniel Wheeler. His oils on canvas and boards will be on display at Workbench Furniture 410 N Fourth Ann Arbor

ART LEADERS GALLERY
Through Sept 30 - *Seduction* an exhibition of world renowned artist Royo featuring original oils and limited edition serigraphs. Fine art handblown glass and bronze sculpture also on display at this new location 33030 Northwestern Hwy West Bloomfield (248)539 0262

BIRMINGHAM BLOOMFIELD ART CENTER
Through Oct 5 - Robert Wilbert Watercolors Robinson Fine Arts Gallery at the BBAC 1516 S Cranbrook Birmingham

CPOP GALLERY
Through Sept 30 - Works by Winston Smith David Le Batard and Tony Agee 4160 Woodward Detroit (313)833 9901

FLATLANDERS ART GALLERY
Through Oct 13 - *Kevin Schroeder - Recent Work* 11993 E U S 223 Blissfield (517)486 4591

FORD GALLERY
Through Sept 15 - Eastern Silversmith's Guild Alumni Show Eastern Michigan University Ypsilanti (734)487 0465

FRAMES N ART
Through September - *Original Watercolors of Betty Sturley* 5889 Dixie Hwy Clarkston (248)623 1552

GALLERY 212
Through Sept 16 - *Guilty Pleasures* an all media group exhibition featuring works by Anthony Kahn John Dinsler Glen Barrack O Summers Rachel Wright Daniel N Marder and Mara Trachtenburg 207 W Liberty Ann Arbor www.gallery212.org

GATE VI GALLERY
Through Sept 14 - *Paintings and Pastels* by Penny Thorsen and Nomi Civic Center Group 45175 W Ten Mile Novi (248)347 0400

HABITAT GALLERIES
Through Sept 29 - Works of Bella Feldman and Emily Brock 7 N Saginaw Pontiac (248)333 2060

ELLEN KYROD ART GALLERY
Through Sept 25 - Two Women Exhibit featuring Eloise Brown Hill and Mary E Corbett (313)833 1300 ext 18

ROBERT KIDD GALLERY
Through Sept 29 - New paintings by Moe Brooker and glass sculpture by Christina Bothwell 107 Townsend Birmingham (248)842 3909

DAVID KLEIN GALLERY
Through Oct 20 - Latin American figurative artist *Fernando Botero Paintings Drawings and Sculpture* 163 Townsend Birmingham (248)433 3700

LAPEER ART ASSOCIATION
Through Sept 30 - Illustrator Fran Plazens and member show Farnsworth Gallery 241 Daley Lapeer (810) 667 3632

LAWRENCE STREET GALLERY
Through September - Three local artists are kicking off the fall art season at the gallery. Images by Juan - *Color Clay, Collage* features Pontiac artist Juan M Limon's photographs Orchard Lake clay artist Eva Monson and collages of Pontiac artist Jacqueline Sullivan a graphic designer for the Observer & Eccentric Newspapers 6 N Saginaw Pontiac (248)334-6716

MANISCALCO GALLERY
Through Sept 25 - *The Artists Among Us/Poets Among Us* features Wayne County poets who have created poems inspired by selected works of art 17329 Mack Detroit (313)886 2993

MEADOWBROOK ART GALLERY
Through Oct 7 - *New Generation Detroit* features contemporary art by eight new Detroit artists celebrating Detroit's 300th birthday 208 Wilson Hall Oakland University Rochester campus (248)370 3005

PAINT CREEK CENTER FOR THE ARTS
Through Sept 22 - *Made in Michigan* an exhibition of more than 50 artists in all media will be showcased in the First Floor Gallery Main Gallery and PCCA grounds 407 Pine Rochester (248)651 4110

THE PRINT GALLERY
Through Sept 15 - *Automotive Images in Art* featuring canvases silk screen prints and posters by various artists 29173 Northwestern Hwy Southfield (248)356 5454

REVOLUTION
Through Oct 20 - *Anne Wilson Edges and Stephen Tourlentes New Work* with artists receptions 5-7 p.m. Sept 14 23257 Woodward Ferndale (248)541 3444

THE SCARAB CLUB
Through Sept 16 - *Within These Walls* South Member Exhibition with an opening reception 6 10 p.m. Sept 7 217 Farnsworth Detroit (313)831 1250

SOUTHFIELD CENTRE FOR THE ARTS
Through Sept 29 - An exhibition of Haitian art and artifacts by Emily C Hall 24350 Southfield Rd in Southfield (248)424-9022

SYBARIS GALLERY
Through Oct 20 - *The Man Who Knew Too Much* a sculpture and jewelry exhibition by J. Fred Woell 202 E Third Royal Oak (248)544-3388

UNIVERSITY OF MICHIGAN MUSEUM OF ART
Through Nov 25 - *Donald Sultan The Smoke Rings* will feature large scale ink prints and small scale photographs in three of the museum's galleries 525 S State Ann Arbor (734)764-0395

WASHINGTON STREET GALLERY
Through Sept 15 - Barry Avedon professor of painting and drawing at Eastern Michigan University will have his works featured in *Painting and Drawing* 215 E Washington Ann Arbor (734)761 2287

THE WOODS GALLERY
Through Oct 11 - Palette and Brush Club Lower level of the Huntington Woods library 26415 Scotia Huntington Woods (248) 543 9720

ZEITGEIST GALLERY
Through October - *Two Painters Robert Hyde and Greg Stevens* with *Stone Sculpture - Ron Gabaldon* 2661 Michigan Detroit (313)965 9192

LECTURES

ACADEMIC FREEDOM
Vartan Gregorian president of Carnegie Corp of New York will deliver a lecture on academic freedom titled *Universities in the 21st Century: Penalties Challenges and Prospects* on Sept 11 at the University of Michigan 412 Maynard Ann Arbor (734)764 0303

DETROIT INSTITUTE OF ARTS
Artist Winnie Owens Hart will lecture at 2 p.m. Sunday Sept 16

MUSEUMS

CRANBROOK ART MUSEUM
Through Sept 23 - *Cranbrook in the City* *Verifying Visions With Detroit* presents the work of Academy of Art alumni and students. Through Sept 30 - *Shaping the Heart of Detroit* the Saarnen Family's plans for the Waterfront (248)645 3300

CRANBROOK INSTITUTE OF SCIENCE
Through December - An exhibit of Great Lakes fur trade with 18th and 19th century artifacts 39221 Woodward Bloomfield Hills 1-877 GO CRANBROOK

DETROIT HISTORICAL MUSEUM
Through Sept 9 - *Island in the City Belle Isle Detroit's Beautiful Island* 5401 Woodward Detroit (313)331 7760

DETROIT INSTITUTE OF ARTS
Building Detroit a look at the city's architectural achievements runs through Sept 30. Through Oct 14 - Gordon Newton *Works on Paper* a retrospective exhibition of the Detroit's Cass Corridor artist's 30 year career 5200 Woodward Detroit (313)833 4005

EXHIBIT MUSEUM OF NATURAL HISTORY
Through Nov 30 - Drawings from the collection of Karen Anne Klein 1109 Geddes Ann Arbor (248)647 7709

HENRY FORD MUSEUM
Presents *Photographer to the World The Detroit Publishing Company* through Jan 6 2002 featuring 19th and 20th Century photographs and color lithographs 20900 Oakwood Dearborn (313)271 1620

MUSEUM OF NEW ART
Opens Sept 14 - *DOCUMENTA USA* called the largest art exhibition in the world runs through Oct 27 1249 Washington Detroit (313)961 2845

UNIVERSITY OF MICHIGAN MUSEUM OF ART
Through Sept 23 - *In Human Touch Photographs by Ernestine Ruben* Through Oct 21 - *Albert Kahn Inspiration for the Modern* an architectural exhibit. Through Nov 21 - *Donald Sultan The Smoke Rings* Museum also features talks concerts tours art videos and more. 525 S State Ann Arbor (734)764-0395

CHARLES H. WRIGHT MUSEUM OF AFRICAN AMERICAN HISTORY
Through Sept 16 - *Detroit Collects Mayhew* Through Jan 13 2002 - *Jazz in Detroit Before Motown A Photographic History* tells the story of jazz in Detroit from 1920 1960 through photos maps and recorded music 315 E Warren Detroit (313)494 5800

THEATRE

BROADWAY ONSTAGE
I Hate Hamlet a comedy by Paul Rudnick runs through Oct 6 21517 Kelly Eastpointe (810)771 6333

CENTURY THEATRE
Fully Committed a comedy about a reservations clerk at a trendy overbooked eatery runs through Dec 31 333 Madison Detroit. For tickets call (313)963 9800

DETROIT PUPPET THEATRE
View Oh Ananse! a puppet show based on a West African folktale every Saturday in September at 2 p.m. 25 E Grand River Detroit (313)961 7777

GEM THEATRE
Dinner With Friends a comedy about friendship in the age of divorce runs through Dec 31 333 Madison Detroit. For tickets call (313)963 9800

AARON DEROY THEATRE
Nancy Gurwin presents *Joseph and the Amazing Technicolor Dreamcoat* which runs through Oct 7 Jewish Community Center campus 6600 W Maple West Bloomfield (248)352 7172

DUBOIS THEATRE
A Little Bit Blue an original comedy show written by local playwrights Marc Holland Mike Davis and Ramon Farhat runs through Sept 29 at the Canton High School theater (810)403-4746

WORKSHOPS

BIRMINGHAM BLOOMFIELD ART CENTER
Offers a Portfolio Workshop to high school students and adults interested in pursuing a career in the arts. 10 a.m. to noon Saturday Sept 15 1516 S Cranbrook Birmingham To register call (248)644-0866

MICHIGAN'S LARGEST

SPORTS CARD SHOW

SEPTEMBER 7-8-9

FRI 12-9 • SAT 10-8 • SUN 10-6

SPORTS CARDS • COMICS • MEMORABILIA • SUPPLIES & MORE!
ADMISSION ONLY \$2.00 PER CARLOAD!

BASEBALL HALL OF FAMER

STAN MUSIAL

SAT SEPT 8TH
1:00 PM - 3:00 PM
\$40.00 BALL OR
FLAT ITEM (up to 11x14)
\$80.00 ALL OTHER ITEMS
(Excluding Bat & Jersey)
\$150.00 BAT OR JERSEY

FORMER WRESTLING STAR

JIM 'HACKSAW' DUGGAN

SUNDAY SEPTEMBER 9TH
1:00 PM 3:00 PM
\$5.00 ANY ITEM

FORMER DETROIT BASEBALL STAR & 1984 WORLD SERIES CHAMP

SID MONGE

SATURDAY SEPTEMBER 8TH
3:00 PM 5:00 PM
\$3.00 ANY ITEM

I-75 & EUREKA RD.
(EXIT 36) TAYLOR
734-287-2000
GIBRALTARTRADE.COM

FREE

FRIDAY ADMISSION
WITH THIS COUPON
FRI DAY SEPT 7TH ONLY

Gibraltar

TRADE CENTER, INC.

OBSERVER & ECCENTRIC GUIDE TO THE MOVIES

National Amusements Showcase Cinemas

Showcase Auburn Hills 1.14 2150 N Opdyke Rd Between University & Walton Blvd 248-373-2660

NP ROCKSTAR (R) SUN 12:30 2:50 5:10 7:25 10:00 MON THURS 5:10 7:25 10:00

NP TWO CAN PLAY THAT GAME (R) SUN 1:15 3:15 5:15 7:30 9:45 MON THURS 5:15 7:30 9:45

Showcase Dearborn 1.8 Michigan & Telegraph 313-561-3449

Showcase Pontiac 1.5 Telegraph Sq Lake Rd W Side of Telegraph 248-332-0241

Showcase Pontiac 6-12 2405 Telegraph Rd East side of Telegraph 810-334-6777

Quo Vadis Warren & Wayne Rds 313-425-7700

MON THURS 4:30 7:00 9:25

SUNK 1:15 3:25 5:35 7:45 9:55 9:30 MON THURS 5:35 7:45 9:55

Showcase Westland 1.8 6800 Wayne Rd One blk S of Warren Rd 313-729-1060

Star Theatres The World's Best Theatres Bargain Matinees Daily 5:00-6:00pm

Star Great Lakes Crossing Great Lakes Shopping Center 248-454-0366

Star John II at 14 Mile 32289 John R Road 248-583-2070

Star John II at 14 Mile 32289 John R Road 248-583-2070

SUMMER CATCH (PG13)

12:40 3:10, 5:40 8:00 10:15 CAPTAIN CORELLI'S MANDOLIN (R) 4:10, 9:10

Star Rochester Hills 200 Barclay Circle 248-853-2268

Star Southfield 12 Mile between Telegraph and Northwestern off I-696 248-353-3378

United Artists West River 9 Mile 1/2 Block West of Middlebelt 248-788-6572

United Artists Commerce-14 3330 Springdale Drive 248-968-5801

Main Art Theatre III 118 Main at 11 Mile Royal Oak 248-342-0180

GHOST WORLD (R) (15 4:15) 7:00 9:45

THE DEEP END (R)

11:30 2:00, 4:30 7:00 9:40 AMERICAN PIE 2 (R) 12:00 2:30 5:00 7:20 9:50

Maple Art Theatre III 4135 W Maple West of Telegraph Bloomfield Hills 248-855-9090

Oxford 7 Cinemas L.L.C. Downtown Oxford Lapeer Rd (M 248) 628-7101 Fax (248) 628-1300

AMC Livonia 20 Haggerty & 7 Mile 734-342-9909

Ford Wyoming Drive-in Theatre Dearborn (313) 846-6910

Cinemark Movie 16 The Best Seat in Town 28600 Dequandre Rd Warren MI 810-558-7520

Waterford Cinema 16 7501 Highland Rd SE corner M 59 & Williams Lake Rd 24 Hour Movie Line 248-666-7900

Waterford Cinema 16 7501 Highland Rd SE corner M 59 & Williams Lake Rd 24 Hour Movie Line 248-666-7900

THE FAST AND THE FURIOUS (PG13)

11:40 1:45 4:45 6:10, 8:10 10:30 THE PRINCESS DIARIES (G) 11:10 1:40 4:15, 6:45 9:20

Birmingham Theatre 211 S Woodward Downtown Birmingham 644 FILM

AMC Livonia 20 Haggerty & 7 Mile 734-342-9909

Ford Wyoming Drive-in Theatre Dearborn (313) 846-6910

Cinemark Movie 16 The Best Seat in Town 28600 Dequandre Rd Warren MI 810-558-7520

Waterford Cinema 16 7501 Highland Rd SE corner M 59 & Williams Lake Rd 24 Hour Movie Line 248-666-7900

Waterford Cinema 16 7501 Highland Rd SE corner M 59 & Williams Lake Rd 24 Hour Movie Line 248-666-7900

Waterford Cinema 16 7501 Highland Rd SE corner M 59 & Williams Lake Rd 24 Hour Movie Line 248-666-7900

'Before Motown' celebrates Detroit's early jazz history

Before Motown: A History of Jazz in Detroit, 1920-1960 By Lars Bjorn with Jim Gallert University of Michigan Press, \$54.50 hardcover, \$24.95 trade paperback

BY HUGH GALLAGHER STAFF WRITER hgallagher@oe.homecomm.net

Ask anyone about music and Detroit and the first thing that pops to mind is Motown, that infectious, smooth, pop style of rhythm and blues that rivaled the British Invasion for popular music supremacy in the 1960s.

Detroit usually doesn't get noticed as a jazz center. Jazz is primarily associated with four cities - New Orleans, Chicago, Kansas City and New York. But while Detroit never produced the distinctive sounds that identify the music of these cities, it contributed to the shifting phases of jazz.

In addition to the rich vein of jazz talent provided the fledgling Motown Records with some of the best session musicians in the world.

'Before Motown: A History of Jazz in Detroit' is a labor of love by jazz fan and University of Michigan-Dearborn professor of sociology Lars Bjorn Bjorn, writing with jazz broadcaster Jim Gallert, tracks the history in jazz in the city from 1920s to the 1960s, exploring the bars, dance halls and small record labels that nurtured jazz.

The history is bolstered by numerous interviews with musicians and fans, clippings from newspapers of time (especially African-American newspapers), and great black and white photos. Many of the interviews were gathered by Gallert over the years he was host of WDET's, 'Jazz Yesterday' program.

Bjorn's expertise in sociology allows him to put the music in the context of social change from the migration of black families in the south to Detroit to the shifting relationship between blacks and whites. Bjorn traces the growth and spread of the black population through the city, and the rise of numerous venues that provided an outlet for jazz musicians.

As Bjorn points out Detroit was a significant player in the development of jazz in two periods, the 1920s and the 1950s, but the city was always a place

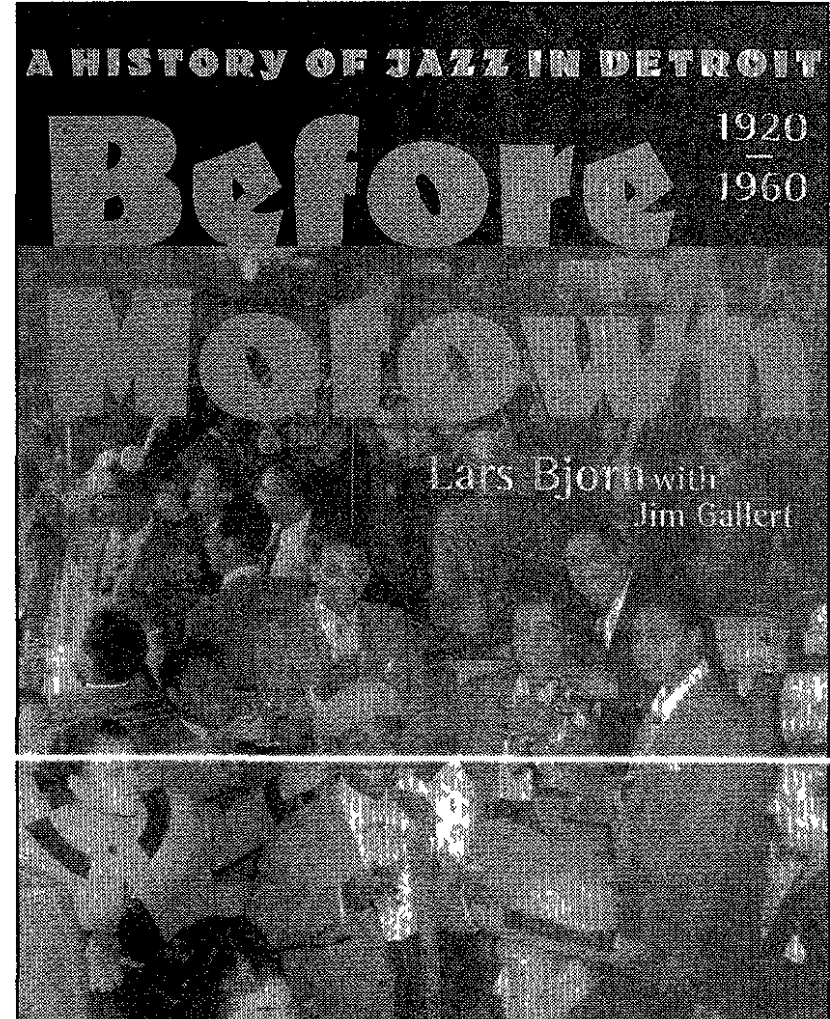

Sounds of the city: A sociology professor at University of Michigan-Dearborn, Lars Bjorn penned 'Before Motown: A History of Jazz in Detroit'

where musicians loved to play and a city that nurtured young talent. Cass Tech High School was especially important as a breeding ground for talent.

While Bjorn and Gallert write about white jazz musicians, clearly the focus, as it must be, is on black musicians in the context of the city's shifting race relations.

In the 1920s, two big bands arose as important national acts, one white, the Jean Goldkette Orchestra, and one black, McKinney's Cotton Pickers. Goldkette's orchestra featured Bix Beiderbecke, the white trumpet player who briefly rivaled Louis Armstrong.

Bjorn tracks the many bands that arose as jazz music went from being a novelty to becoming the popular music of the 1930s. Black and white bands each had their own clubs, saloons and dance halls. Detroit's Paradise Valley had a score of night spots featuring the new music.

National attention shifted more and more toward New York and away from Chicago and Detroit as the big bands of Duke Ellington and Benny Good-

man took center stage. But by the early 1940s, jazz took another turn with the creation of bebop. Bjorn and Gallert claim the 1950s as Detroit's most important period, both as a place for musicians to play and as a source of musicians.

The names a prominent jazz musicians to emerge from Michigan during this period confirms their view including the Jones brothers (Hank, Thad and Elvin), Tommy Flanagan, Pepper Adams, Kenny Burrell and Yusef Lateef. Bjorn and Gallert draw on the oral histories to show how several Detroit clubs became incubators for the new music including the Blue Bird and Baker's Keyboard Miles Davis came to live briefly in Detroit to escape his drug connections and play freely.

The book makes the connection between jazz, the blues and rhythm and blues. Many local jazz musicians brought their musical sophistication to the Motown sound.

This book combines social history, nostalgia and best of all dozens of personal memories to tell a forgotten jazz story.

Jazz symposium featured at museum

A Detroit Jazz History Symposium will be held 11 a.m. to 4 p.m. Saturday, Sept. 29, at the Charles H. Wright Museum of African American History, 315 E. Warren Ave., Detroit. The symposium is sponsored by the museum and the University of Michigan-Dearborn.

The symposium will feature lectures, panel discussions and live performances. The event is in support of the museum's current exhibition, 'Jazz in Detroit Before Motown 1920-1960.'

The day will begin with a lecture on the history of jazz in Detroit presented by Lars Bjorn,

professor, University of Michigan-Dearborn, and Jim Gallert, Detroit jazz historian, co-authors of the book, 'Before Motown: A History of Jazz in Detroit, 1920-1960.' They will include recorded music and photographs in their presentation.

Photographers Bob Douglas and James 'Beans' Richardson will be on hand to discuss their experiences and prolific work in capturing the music scene in post-World War II Detroit in the session, 'Photographing Detroit Jazz.'

A panel discussion will feature Detroit jazz musicians from the

1940s-50s including bassist 'Beans' Richardson, saxophonist George Benson, pianist Johnny Allen, bassist Will Austin and drummer Bert Myrick. Benson, Allen, Austin and Myrick will conclude the program with a performance.

The fee for the symposium is \$15 for non-members, \$10 for members and includes a luncheon and museum admission.

For reservations or more information on the symposium or the exhibit, call the museum at (313)494-5800, Ext. 0.

BOOK HAPPENINGS

Book Happenings features events at area bookstores, libraries and literary gatherings. Send news leads to Steve Kowalski, Eccentric Newspapers, 805 E. Maple, Birmingham, MI 48009, or fax them to (248) 901-2573 or e-mail to skowalski@oe.homecomm.net.

Baldwin Public Library in downtown Birmingham has the following event planned.

THROUGH SEPTEMBER The Children's Buggy Art Show, a collection of children's drawings and poems of insects, will be exhibited.

Barnes & Noble, at 2800 S. Rochester in Rochester Hills, has the following events planned.

THURSDAY, SEPT. 13 Writers' Group Workshop meets the second Thursday of each month at 7 p.m. Want to be a writer? Dying to be published? Glean words of wisdom and gather encouragement along the

way. Call Dee Eurs at (248)853-9939.

TUESDAY, SEPT. 18 Book signing and presentation by Karen Elizabeth Bush, author of 'First Lady of Detroit: the Story of Marie Therese Guyon, Mme Cadillac,' which recreates the life of a remarkable woman with historical detail and entertaining dialogue. Book appeals to young and old. 7 p.m.

THURSDAY, SEPT. 20 SciFi & Fantasy book Club meets for a discussion of John Cramer's book 'Einstein's Bridge, a hard or real science fiction read. 8 p.m.

SATURDAY, SEPT. 22 Presentation with Q & A followed by a book signing from Lylas G. Mogk, M.D., author of 'Macular Degeneration: The Complete Guide to Saving and Maximizing Your Sight.' 2 p.m.

TUESDAY, SEPT. 25 The Israel B. Richardson Civil War Roundtable, hosted by historian Bill Grandstaff, meets the

second Tuesday of each month. This month's topic centers on Abraham Lincoln. New members welcomed. 7:30 p.m.

Barnes & Noble, at 6800 Orchard Lake in West Bloomfield, has the following events planned.

WEDNESDAY, SEPT. 12 Author Arthur W. Wiggins, professor of Physics and Physical Sciences Department Head at Oakland University, will sign copies of his newest book, 'Quantum Leaps in the Wrong Direction.' Get the straight story on things like astrology, ghosts, psychic surgery and ESP. 7 p.m.

FRIDAY, SEPT. 14/SATURDAY, SEPT. 15 Hat's on Storytime. Wear your favorite chapeau to our swingin' sombrero storytime. We'll even make a funny hat for you to wear. And this time only, you can keep your hat on indoors. 11 a.m. each day.

ART BEAT

Art Beat features various happenings in the suburban art world. Send Wayne County arts news leads to Art Beat, Observer Newspapers, 36251 Schoolcraft Livonia MI 48150, fax them to (734) 591-7279 or e mail (as a text file) to lchomin@oe.homecomm.net

WRITING SEMINAR

Are you tired of writer's block? Need inspiration to pick up a pen or some tips to help write a story? Cheryl Vatcher can help you during a writing seminar offered 1 2 30 p m Monday, Sept 10 and 17 at the Plymouth Coffee Bean on Pennman (\$30), 1 3 30 p m Saturday, Sept 15 and 29 at the Alfred Noble Library 32901 Plymouth Road (\$42), and 1 2 30 p m Thursday, Sept 13 and 20 and 6 7 30 p m Friday, Sept 28 at LaMocha Coffee House, 7660 North Canton Center Road (\$30)

Vatcher, a Plymouth writer who earned a master's degree from University of Michigan's School of Education, has penned articles for several metro Detroit newspapers. To register, call (734) 414-8680

FARMINGTON ARTISTS MEETING

D. J. Paulson, great-granddaughter of Vincent van Gogh's first cousin, will present and in depth lecture on the life of the artist 8 p m Wednesday, Sept 12 at the Costick Activities Center in Farmington Hills

The evening begins with a Farmington Artists Club meeting at 8 p m. It is open to the public at no charge

For more information, call (248) 661-4863

OPENING RECEPTION

Meet Livonia artist Electra Stamelos at a reception 5 7 30 p m Friday, Sept 14 in the Alfred Berkowitz Gallery on the third floor of the Mardigan Library at the University of Michigan-Dearborn, 4910 Evergreen

The work will remain in the gallery through Friday, Oct 19. Stamelos is one of the artists in the University of Michigan-Dearborn's collection

For information, call (313) 593-3592

ART MARKET

The Northville Arts Commission holds its 15th annual Art Market 10 a m to 8 p m Saturday, Sept 15 and 11 a m to 5 p m Sunday, Sept 16 on Main Street in downtown Northville

A juried fine arts show the Market features photography, Victorian stained glass, furniture, fiber art, metal and sculpture, jewelry and paintings. It kicks off with the Victorian Festival which kicks off with a parade 6 30 p m Friday, Sept 14. For the next two days, the streets will fill with townspeople, artists and business owners who transform Northville into a Victorian village complete with period costumes, free horse and carriage rides, storytellers, strolling musicians and street entertainment

Founded in the early 1800s,

Northville came of age during the Victorian period. The festival, sponsored by the Northville Chamber of Commerce, celebrates the town's heritage. For more information, call the chamber at (248) 349-7640 or visit the Web site at www.northville.org

DETROIT FESTIVAL BUS TRIP

The cultural arts division of the cities of Farmington/Farmington Hills is hosting a bus trip to the Detroit Festival of the Arts Saturday, Sept 15. The bus leaves at 10 a m and returns at 4 p m to the Costick Center on 11 Mile, east of Middlebelt

The fee is \$10 adults, \$5 children. To register, call (248) 473-1800

More than 60 hands-on activities will keep the kids busy at the *Ville Detroit - A Children's Colonial Village* as they create miniature tall ships, test their skills in Colonial games, and make period arts and crafts. Other events include the comedy team Gould & Stearns who combine dialogue, slapstick, mime and song in "Fee Fie Fo Fun," a hilarious version of *Jack and the Beanstalk*

SINGING SHEPHERDS WANTED

ConLen Productions is seeking singers for a shepherds' chorus in the production of Gian-Carlo Menotti's *Amahl and the Night Visitors*. This one-act opera is sung in English with a Christmas theme

Performances will be held weekends between December and January. Rehearsals are scheduled for Sundays at Evola Music in Canton beginning 3-4 30 p m Sept 30. There is no audition

For more information, call Len Poma at (734) 459-2332

ARTIFACTS ART CLUB

Carol Taft will show slides and talk about mixed media at the Artifacts Art Club meeting 7 30 p m Tuesday, Sept 18 at the Livonia Civic Center Library, 32777 Five Mile, east of Farmington Road. The public is welcome

Artifacts members will show their work Monday, Sept 17 to Friday, Oct 12 at Gate VI Gallery in the Novi Civic Center, 45175 Ten Mile, between Taft and Novi roads

Hours are 8 a m to 9 p m Monday-Friday. Call (248) 347-0400 for weekend hours

RIISING STAR SINGERS

Village Music will be auditioning new members for the Youth Showchoir (ages 8-16), The Rising Star Singers, 7 8 30 p m Tuesday, Sept 18 at 130 East Liberty in Plymouth's Old Village

Bring a prepared song. Rehearsals will be held 7-8 30 p m Tuesdays. For more information, call director Norma Atwood at (734) 354-9825

Village Music Studio offers private lessons in piano, voice and dulcimer as well as Kindermusik classes for children from birth to age 7. Group piano classes, ages 5 to adult, are also available



Bus Trip: This tile by Sara Frank is one of the hundreds of art works visitors won't want to miss when they take a bus trip to the Detroit Festival of Arts. The cultural arts division of the cities of Farmington/Farmington Hills is hosting the excursion

CALL FOR ARTISTS

The Westland Chamber of Commerce is looking for professional art in all media by area artists for a silent auction to be held at Taste of the Arts 6 p m Tuesday, Nov 27 at the Hellenic Cultural Center on Joy Road in Westland

The third annual event is a fund-raiser for the Chamber and Family Resource Center in Westland. Last year about 600 people enjoyed food and beverages from 20 area restaurants, live entertainment, artwork by Wayne-Westland students, and a silent auction featuring about 40 artworks. This year's event will have a holiday theme

For information, call (734) 326-7222

ARTISTS NEEDED

North Farmington High School is looking for artists and crafters for its annual Holiday Arts & Crafts Show Saturday, Nov 17

This is a juried show. No manufactured goods. Media include pottery, silk flowers, dried flowers, baskets, candles, photography (other than Detroit), wood shelves or anything unusual. Other items wait listed at this point

For more information, call Dianne at (248) 553-0913

HISTORICAL SOCIETY CONFERENCE

On Friday-Sun-

day, Oct 5-7, the Historical Society of Michigan will present *Detroit's Story 300 Years of Opportunity, Diversity and Success*, a conference on Detroit's history. The conference brings together noted scholars, including the Honorable Damon J. Keith, U.S. District Court of Appeals, and Philip Mason, history professor at Wayne State University

The program will focus on opportunity, diversity and success. Tours of specific sites associated with the city's development will be available. Members of the historical and genealogical societies, educators and the community are invited to participate

Along with Keith and Mason, other speakers include Esther Gordy Edwards, Doug Fraser, Arthur Johnson, and Mary Ellen Riordan. Special programs will be held at the Detroit Historical Museum, Walter P. Reuther Library and the Museum of African American History

For more information or a registration flyer, visit the Web site at www.hsofmich.org or call the Historical

Society of Michigan at (734) 769-1828

ACTING CLASSES

Registration is currently underway for Redbud Productions' acting classes for adult actors, and high school and middle school actors. Taught by director/actress Loretta Grimes, the class concentrates on the techniques of Sanford Meisner. Sessions will include emotional work, improvisation and scene study

Classes begin Saturday, Sept 15 (1 30-3 30 p m adults, 3 30-5 30 p m high/middle school students) and run through Dec 1 in Ann Arbor. Tuition is \$100. Space is limited. Call (734) 663-7167

Grimes trained at the American Academy of Dramatic Arts in New York where she learned Meisner's technique. She encourages students to act moment-to-moment, recalling emotional images from their past to serve as a background for their characters' emotional state of mind

Schoolcraft College PRESENTS

Culinary Extravaganza 2001

A FOOD AND WINE EVENT
SUNDAY, SEPTEMBER 23, 2001
2:00 P.M. - 5:00 P.M.
Waterman Center

- ♦ **Chef Keith Famie**, cookbook author and a television Survivor®, will cook and sign his book.
- ♦ **Master Sommelier Madeline Triffon** of Unique Restaurant Corporation will conduct a wine tasting seminar
- ♦ Live auction includes such delicious items as jewelry, restaurant, gift and travel packages

The Extravaganza will raise funds for student scholarships and assist Schoolcraft students in reaching their career goals

\$40 per person, 2 for \$75.00 Charge to VISA, MASTERCARD or DISCOVER
Call 734-462-4670

Schoolcraft College is on the east side of Haggerty Road in Livonia between 6 and 7 Mile Roads. Signs will direct you through campus construction to parking and the Waterman Center

Participating restaurants, companies include:

American Harvest Restaurant	Essence Restaurant	Opus One
Arbor Brewing Company	Excalibur Restaurant	Over The Top Catering
Ashby's Sterling Ice Cream	Five Lakes Grill	Pelee Island Winery
Bonfire Bistro & Brewery	Great Oaks Country Club	Pillsbury
Busch's	Greektown Casino	Ritz-Carlton
Cadillac Coffee Company	Guernsey Dairy	Steve & Rocky's
Carmela Specialty	Henry Ford Museum	The Farm Restaurant
Food Distributors	L.A. Express	The Golden Mushroom Restaurant
Carver's Steak and Chops	La Shish Restaurants	Tom's Oyster Bar
Central Distributors of Beer, Inc.	Local Color Brewing Company	Tribute Restaurant
Cooker Bar & Grille	Loving Spoonful	Vent Uno (MGM Grand Detroit Casino)
Dearborn Hyatt	Mama Mucco's Pasta	Vine 2 Wine
Elite Catering Company	Michigan Grape & Wine Council	Zingerman's Bakehouse
Emily's	Michigan Star	Zoup
Epoch Event	Clipper Dinner Train	
	Morel's	
	Motor City Casino	

NEIL SIMONS Comedy Hit

THE SUNSHINE BOYS

The Sunshine Boys, starring Dick Van Patten & Frank Gorshin

Showtimes: Saturday September 15th 2:00 and 5:00 pm
 Sunday September 16th 4:00 pm

The Ford Community & Performing Arts Center
 15801 Michigan Avenue
 Michigan & Greenfield, Dearborn
313.943.2354

An evening that keeps you laughing and then leaves you moved. The NY Times

LOOK IN TODAY'S JOBS AND CAREERS CLASSIFIED SECTION FOR THESE COMPANIES...

FOR THESE COMPANIES...

Art Van	SYSCO Food Services of Detroit, Inc.	SPECIALTREE
City of Southfield	Oakwood	FLAGSTAR BANK
DAY	ROUSH	Panera
Standard Federal	Metro Times	BURGER KING
		OAKLAND COMMUNITY COLLEGE

They Are Hiring Now!

The right bra works wonders

CYBER SHOP



CARI WALDMAN

I never realized until recently how important the right bra is to looking good

Standing in front of a three-way, dressing room mirror, trying on blouse after blouse and one slinky T-shirt after another, I quickly decided it was time to not only invest in new fall clothes, but also toss out this summer's comfortable cotton sports bras and buy a new collection of undergarments

According to research, most bras wear out and function less optimally after six months of use

Furthermore, bras need a day of rest after wear to return to their original fit, say the bra police. Wearing the same bra over and over again puts stress on the garment's fabric and causes it to stretch and lose its fit more rapidly, the experts say

Okay, hopefully I've gotten you to ask yourself "When is the last time I had a really good fitting bra?" In any case, fall fashion is packed with body-clinging fabrics, so why not take inventory of your undergarments and learn more about achieving a good fit

General tips to get you started

■ To achieve good support, make sure your bra fits properly. You need to fit fully into the cup of your bra, and the cup needs to entirely support you. A common trick is to bend over, place all tissue into the cup, then stand and center yourself in each cup at the seam of the bra

■ For the best support and comfort, the back band of your bra should be anchored at or below your shoulder blades

■ If you wash your bras in the washing machine, place them in a mesh lingerie wash bag to protect them from being wrapped around the agitator or other clothing

Avoid putting your bras or panties in the dryer. The heat of the dryer breaks down Lycra, spandex and elastic so you will find yourself replacing undergarments more frequently

Here are a few tips aimed at fall fashion trends

■ Seamless style bras are a good bet for fall, as knits are popular

■ With low-cut and plunging necklines, it's always nice to get a little extra lift and cleavage. Try a lightly lined seamless and padded bra

■ To prevent blouses from pulling or gapping in front, try a "minimizer." They reduce the bust line by one or two inches and give you a rounded shape

Now that we've learned about proper fit and bra styles that suit fall fashion trends, grab a cup of tea and head for your computer. I found the experience of buying bras on-line to be a seamless fit with my busy life

Cari of West Bloomfield is a free lance stylist and writer. Please send your Internet shopping questions to Cari at OECSBERSHOP@AOL.COM

Click Pick:

www.bare necessities.com

Description: The site is broken down by category (bras, shape wear, panties and hosiery). It's also chock full of name brands like Calvin Klein and Maidenform

Navigation: You can browse by product, brand or bra size. Sizes range from 30A to 52I

The site loads quickly and is easy to navigate. The location for special offers and mail-in rebates is easy to spot. Currently, on-line shoppers who buy a Bah bra, get one free by mail. Also, visit the site's clearance area. While sizes are limited, the deals on such name brands as Chantelle and Ultimo are fabulous

Shipping: A flat shipping rate of \$4.95 is charged. You can feel secure about your purchases since there is a 100-percent guarantee on returns and exchanges. You will find a return form enclosed with your order, but shoppers are responsible for the cost of returning merchandise

Feminine Florence

Local clothier talks shopping, culture in latest travel book for women

BY NICOLE STAFFORD
STAFF WRITER
nstafford@oe.homecomm.net

Lynn Portnoy loves to dress the women who come to her clothing boutique

But dressing up is more than meets the eye at Lynn Portnoy Women's Clothier in Southfield

At the risk of sounding silly, it's a defiant assertion of womanhood, though Portnoy cares about fashion, the act of exalting the female perspective — and prodding women to experience the world through their eyes — is what drives her

As she drapes a "fabulous" Italian wool wrap over a pair of petite shoulders, yes, Portnoy is selling a stylish stole. But she's also peddling the splendor of being a woman

The same principle informs Portnoy's travel books, *Going Like Lynn: A Series of Liberating Travel Primers for Women*, the latest of which takes readers across the Atlantic Ocean to the Renaissance city of Florence

Portnoy is slated to sign copies of her latest primer at local Borders stores 2 p.m. Sunday, Sept. 16 at the Birmingham store, 7 p.m. Monday, Oct. 8 in Novi and 2 p.m. Sunday, Oct. 14 in Beverly Hills. However, *Going Like Lynn - Florence*, as well as Portnoy's guides to Paris and New York, sell at Borders stores and by direct order

"Most guide books are geared towards businessmen or are a more general source," says Portnoy, who traversed the globe all by her lonesome as a clothing buyer for Claire Pearson, a well-known metropolitan Detroit women's clothing boutique that did business in what is today the Somerset Collection

"I want a little hotel with a concierge who knows I've come home," says Portnoy, alluding to women's No. 1 worry about traveling alone: personal safety

But such hurdles are precisely why Portnoy, who's toiled around solo in such places as Afghanistan and Guatemala, writes travel books, arm them with knowledge and unleash the traveling fool in them all. This isn't a dress rehearsal," she comments, rather seriously. "What are they waiting for?"

So, rather than catalogue the major hotel chains, Portnoy ticks off a tiny list of small, neighborhood hotels — former palaces, mansions and villas in the case of *Going Like Lynn - Florence* — where the concierge is likely to be a member of the family that runs the hotel

Instead of a lengthy description of every major tourist attraction, Portnoy goes straight to the female heart: dining, culture and shopping, broken down into three chapters. In each, she describes her personal favorites and provides all the essential tourist information. But pay close attention, some of Portnoy's selections veer off the beaten path

Have you ever heard of Florence's cat houses?

Do you know where can you buy leather and feel spiritually nourished simultaneously? The answer to the last question is inside the S. Croce Church. "It's the only place I know where you can pray and shop," jokes Portnoy

As with all her guides, Portnoy weaves her recommended destinations into a time-efficient itinerary followed by a resource list to close the primer

Her signature instruction on how to pack a travel wardrobe in one bag follows the first chapter "Pre planning"

"I think I knew I was going to be a traveler when I had my first spunking," recalls Portnoy. "I dug up the rose garden because I wanted to see China. Children were told then that China was down there. And I invited



STAFF PHOTO BY JIM JAGDELD

World traveler: Lynn Portnoy, owner of Lynn Portnoy Women's Clothier in Southfield, introduces her latest travel primer for women, *Going Like Lynn - Florence*. She'll sign copies of the book at area Borders stores in September and October

all the neighborhood's children over to help dig." But fear not, Portnoy won't make you want to dig, just travel. To directly order any *Going Like Lynn* guide, call (888) 386-9688, visit www.goinglikelynn.com or visit Lynn Portnoy Women's Clothier, 29260 Franklin Road in Southfield

Retail, style and special store events are listed in this calendar. Please send information to Malls & Mainstreets, c/o Observer & Eccentric Newspapers, 805 E. Maple, Birmingham, MI 48009. By fax, (248) 644-1314. E-mail, nstafford@oe.homecomm.net. Deadline for publication is two weeks in advance.

MONDAY, SEPTEMBER 10

YARN GARMENT SHOW
The Knitting Room, 251 Merrill Street in Birmingham, hosts a samples show of garments made with fibers from Rowan Yarns featuring both current and new yarns, through Sept. 16. Store hours are 10 a.m.-5 p.m. Monday-Friday and 10 a.m.-4 p.m. Saturday. For additional information, call (248) 540-3823

WEDNESDAY, SEPTEMBER 12

ESCADA FOR FALL
Saks Fifth Avenue, the Somerset Collection in Troy, presents the Escada fall 2001 collection in an informal fashion show with light buffet lunch, noon, Escada Boutique, second floor. Tickets are \$25 and benefit the Michigan Chapter of the Arthritis Foundation. Please make reservations by Sept. 10 by calling (248) 424-9001, ext. 40

ANNUAL FASHION SHOW
Join fashion followers at the 12th Annual Birmingham Fall Spectacular featuring fall fashion from Birmingham merchants plus live and silent auctions, a strolling dinner and entertainment, 5:30-9:30 p.m., outside under tents between the Townsend Hotel and The Community House in downtown Birmingham. The event benefits the Beaumont Pediatric Cancer Survivors Scholarship Fund. General admission tickets are \$65 in advance and \$75 at the show. Patron seats are \$175 and benefactor tickets are priced \$250. For more information or to purchase tickets, call (248) 644-1700. Tickets may also be purchased at the following

ADDED ATTRACTIONS

Birmingham stores: Astrein's Jewelers, Tender and Imelda's Closet, all on Maple Road

THURSDAY, SEPTEMBER 13

CASHMERE TRUNK SHOW
Lynn Portnoy Women's Clothier, 29260 Franklin Road in Southfield, presents a trunk show of Forte Cashmere, through Sept. 15. Show hours are 11 a.m.-7 p.m. on Thursday and 11 a.m.-6 p.m. on Friday and Saturday. For more details, call (248) 353-2900

TRUNK SHOW
Sherrin's at the Orchard Mall in West Bloomfield features Skinz Designs in a trunk show with informal modeling, through Sept. 15. For more information, call (248) 626-7470

BRIDGE COLLECTIONS SHOW
Saks Fifth Avenue, the Somerset Collection in Troy, presents the Best of Bridge, a showing of fall 2001 sportswear collections, to benefit The Child Abuse and Neglect Council, 5 p.m. wine and hors d'oeuvre reception, 6 p.m. fashion show, Designer Bridge Sportswear, second floor. Tickets are \$35 and \$50. To make a reservation, call (248) 332-7173

FRIDAY, SEPTEMBER 14

JEWELRY TRUNK SHOW
PR Haag Jewelers in downtown Rochester presents a trunk show of Nagalle opal inlay jewelry through Sept. 15, 10 a.m.-9 p.m. on Friday and 10 a.m.-5 p.m. on Saturday. For additional information, please call (248) 652-3660

JEWELRY DESIGNERS VISIT
Jules R. Schubot Jewellers, 3001 West Big Beaver in Troy, welcomes jewelry designers Leo de Vroomen of

De Vroomen Designs and Gianni Stivanello of Ambrosi, along with their recent collections, at a champagne reception, noon-8 p.m. The designers and their collections will also be in the store from 11 a.m. to 5 p.m. Saturday, Sept. 15. For more details, call (248) 649-1122 or (800) SCHUBOT

SATURDAY, SEPTEMBER 15

HOMECOMING PREVIEW
Jacobson's stores in Birmingham, Livonia and Rochester Hills give teens a head start on shopping for homecoming with a Ms. J homecoming party event through Sept. 16. For more information, call the store near you: (248) 644-6900 in Birmingham, (734) 591-7696 in Livonia and (248) 651-6000 in Rochester Hills

BILL BURNS VISITS
Meet designer Bill Burns and view his fall collection at Nordstrom, the Somerset Collection in Troy, 11 a.m.-2 p.m. Event includes informal modeling and lunch in Studio 121, second floor. To make a reservation, call (248) 816-5100, ext. 1550

THURSDAY, SEPTEMBER 20

POWER CARD SHOPPING DAY
Purchase a power card for \$50 and enjoy a discount of 20 percent at Saks Fifth Avenue, the Somerset Collection in Troy (some restrictions apply). The event benefits the Junior League of Birmingham and Ilitch Charities for Children. Cards must be reserved by Sept. 10. For more information or to purchase a power card, call (248) 646-2613

BOBBI BROWN EVENT
Nordstrom, the Somerset Collection in Troy, presents the Bobbi Brown Great Faces event featuring personal appointments at the Bobbi Brown makeup counter. To schedule an appointment, call (248) 816-5100, ext. 1417

WHERE CAN I FIND?

This interactive feature is dedicated to helping readers locate retail merchandise that's difficult to find through reader feedback.

If you have a request or information about where a product is sold or service is available, call (248) 901 2555 and leave a message with your name and phone number.

Please be patient about your requests and feedback, we receive an overwhelming number of phone calls. If you don't see information about your request, we couldn't find it. Requests are published twice.

WHAT WE FOUND:

- Pine tar soap can be purchased at local Whole Foods stores and at Zerbo's in Livonia, call (734) 427-3144

- Pretty Feet products (now called Hand and Pretty Feet products) can be purchased at Warren Drugs in Farmington Hills, call (248) 855-1177

- Paper doll cut-outs can be purchased at Books Abound in Farmington, call (248) 477-8777

- Vel's soap, Fels Nappa soap and Kirk's Castile soap can be purchased at the IGA store on Orchard Lake and 10 Mile roads in Farmington

WHERE CAN I FIND?:

- A consignment shop that accepts and sells men's suits for Katherine, a resident of West Bloomfield

- A small, old-fashioned office supply or art supply store that carries good felt drawing pencils for Sylvia, a resident of Redford

- An Internet site where vacant prop-

erties for sale are listed for Ronald, who lives in West Bloomfield

- A store where an 80-inch round bed sheet can be purchased for Irene

- A store where Coty lipstick in the shade Plum Vine can be bought for Clare

- A store where a telephone for the hearing impaired or phone voice magnifier can be bought for Betty, who resides in Livonia

- A store where a red bowl from a nest of four Pyrex mixing bowls (#402) can be bought for Janet, who lives in Rochester Hills

- A store that sells old-fashioned shaving mugs for Paul, who resides in Farmington

- A restaurant that serves Finn & Hattie, a fish dish formerly served at Muer restaurants for Marilyn, a resident of Southfield

- A store that sells children's cassette tapes with recorded birthday messages for Anne, who resides in Redford

- A business in the Farmington area where home craft items are taken on consignment for Marian

- A store that sells Cope aspirin for Debbie

- A store where Heinz macaroni and cheese in a can be purchased for Virginia, who lives in Redford

- A store where the Get Sexy perfume can be purchased for Mary

- A store where purses by Ambassador can be bought for Jo, who resides in Canton

- A store where Finish or Calgonite dishwasher detergent is carried for Lorraine

- A store or business where a videocassette tape of the film *Tour of the White House with Jacqueline Kennedy* made in 1962 can be purchased for Joanne, a resident of Livonia

- A store where a videocassette tape of the children's animated film *Hug a Bunch* made in 1984 can be bought for Cindy

- A store that sells L'Origin perfume by Coty for Lois, who resides in Clarkston

- A store or business where table ware and kitchen pieces (dishes, salt and pepper shakers and cookie jar) in the pattern Blue Ribbon Goose can be purchased for Pat, who lives in Bloomfield Hills

- A store or business in the Southfield or Royal Oak area that buys used women's clothing or takes it on consignment

- A store that sells vinyl siding made by All Side in the color Glacier White for Steve

- A business or company that will repair a 1950s pinball machine for Carol

- A store that sells American Western or Northwest blue jeans (which were carried by Montgomery Wards) for Grace

- A store or business that sells or rents new or used 16-millimeter movie projectors (sound is optional) for Don

- A store that sells ladies shirtwaist dresses for Edith

- Compiled by Sandi Jarackas

a la carte

STUFF WE CRAVE

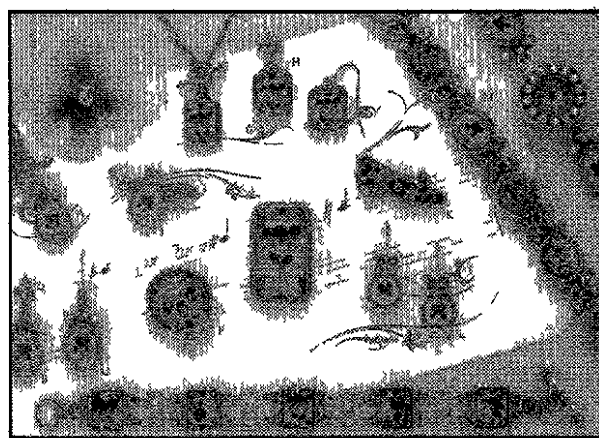

Touch of purple: Maximal Art introduces the *Pressed Pansy* Collection of jewelry. The handmade pieces are set in 14-karat gold plate with Austrian crystals and include earrings, pins, toggle bracelet and bracelet watch, \$28-250, available at Ribbons, Lori Karol and Savoir Faire in Birmingham and Paige Stanton Handmade in Franklin.

School wear: Hooded fleece tops and track pants scream cool comfort, \$26-28 at Mervyn's stores

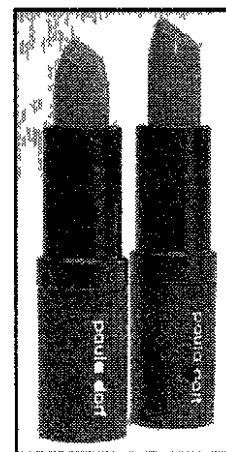

Anything but humdrum: Paula Dorf's lipsticks pump up a party feeling in shades such as *Holiday*, *Loopy* and *Luscious*, \$16 at local department stores

Tiffany & Co. hosts first in-store bridal show

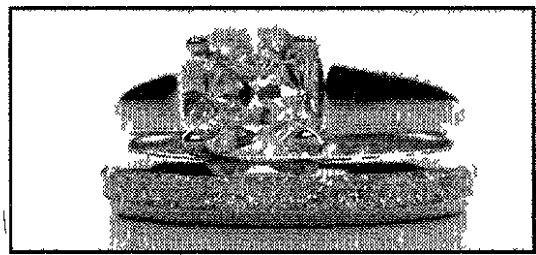

The ring: Tiffany & Co introduces LUCIDA, a new diamond cut, ring setting and band for the big day.

Future brides and bridegrooms are invited to attend The Tiffany Bridal show, Tiffany & Co's first in-store bridal event

Slated 6:30-8:30 p.m. Tuesday, Sept. 11 at the retailer's store in Troy at the Somerset Collection, it features three bridal seminars and a presentation of bridal fashions by Alvin's Brides

The evening begins with cocktails at 6:30 p.m.

Event seminars follow *A Guide to Tiffany Pearls* at 7 p.m., *Tiffany Tablesettings* at 7:20 p.m. and *Selecting Wedding and Social Stationery* at 7:45 p.m.

Information about wedding entertainment, catering, floral services and photography will also be available. Retail participants include Epoch Events Catering and Thrifty Florist/Nature Nook, BBJ Linens and Elegant Cakes by Josef's Bakery

Tiffany & Co. will offer engraving at no charge for attendant gifts and wedding bands purchased at the event

Also, one lucky bride will win a Tiffany bridal shower in a drawing

For more information or to make a reservation, call Margot Abramson at (248) 637-2800

Best sales in town

Calling all savvy shoppers!

If you come across a great sale or bargain that's slated to last through this week and next, let us know

Be sure to include the store name, its location and the merchandise on sale. Please be as specific as possible.

We'll publish the best of the best sales in town as information becomes available to us.

Send an e-mail to nstafford@oehomecomm.net or call (248) 901-2567



Five Star Expo

Participating Chambers: Garden City, Inkster, Redford, Wayne, and Westland

Joy Manor, 28999 Joy Road, Westland

Thursday, September 13, 2001 11:00 p.m. - 6:00 p.m.

Open to the public 2:00 - 4:00 p.m. - Admission \$2.00

Major Sponsors of this event:

Joy Manor-Westland, National Wholesale Printing-Plymouth, Observer & Eccentric Newspapers-Livonia, and Sign-A-Rama of Garden City

5-STAR LUNCHEON

THURSDAY, SEPTEMBER 13, 2001

12 NOON

Guest Speaker: Joe Caruso

of the Caruso Leadership Institute

Joy Manor, 28999 Joy Road, Westland

\$25.00 Members - \$30 Non-Members

Reservations required by September 10, 2001

Tickets may be purchased from any of the participating

Chambers of Commerce

Luncheon Sponsored by National City Bank

Business-to-Business Hors d'oeuvres Networking Event

THURSDAY, SEPTEMBER 13, 2001

4:00 - 6:00 p.m.

Joy Manor, 28999 Joy Road, Westland

\$20.00 Members - \$25 Non-Members

Sponsored by Fire Systems of Michigan, Inc

5:30 p.m.

MYSTERY GUEST DOOR PRIZE

Sponsored by Orin Jewelers

Contributing sponsors of this event:

VR Metro Mall
My Lady's Florist
Presbyterian Village of Redford
TDS Metro Com
Community Choice Credit Union
Dearborn Press & Guide
DeRos

Harry J. Will Funeral Home
National City Bank
Fire Systems of Michigan, Inc.
Michigan Community News
Orin Jewelers
Thomas J. Best/Wayne Oakland Building
Verizon Wireless

FIVE TOP REASONS TO ATTEND THE 5-STAR EXPO:

1. Increase your customer base!
2. Networking - Networking -Networking
3. Develop business relationships and new partnerships
4. Explore price and product comparisons
5. Discover new products and services available in your area

TRAVEL

Testing science centers for fun

BY ALICE RHEIN
STAFF WRITER
arhein@oe.com

Just like every living organism has its own unique characteristics, so do science centers. I did some experimenting this summer, traveling to five science centers, and have some interesting results to report. These are presented in no particular order.

New science center

It's an architectural example of phoenix rising from the ashes. The exposed ducts and elevators only add to the techno feel of the place, and, prase be, the equipment is all in working order - so far. That was the main criticism about the old center. Nothing worked. Here, lights blink, water flows, drums drum - you get the idea.

The New Detroit Science Center is based on the curriculum followed by Michigan science teachers. There is a section on waves and vibrations, which includes sound waves and our favorite light wave mnemonic ROY G BIV. The Daimler Chrysler Motion Laboratory gives demonstrations of principles of science, such as friction and kids can be chosen to glide along the floor in a hovercraft.

The IMAX Dome Theatre has

Toledo	www.cositoledo.org/
Ann Arbor	www.aahom.org/
Cranbrook	www.cranbrook.edu/institute
Detroit	www.sciencedetroit.org/
Cleveland	www.greatscience.com/

a new screen and a better sound system. And on the fourth floor is the special exhibition area.

I would hope the center is a work in progress, as there is little in the way of explaining the point of many of the experiments. Sure, you want to ignite the spark of curiosity in little minds, but don't leave them guessing. A few placards here and there to provide explanations and the New Detroit Science Center is well on its way to being a place where learning can be fun.

Cranbrook Institute

It's still the best place to take in the natural sciences. And no place can come close to rephrasing the beauty of its Bloomfield Hills grounds. Cranbrook offers those budding geologists plenty of rocks and minerals to view. Years ago it was pretty much a place where parents repeatedly told their children "do not touch." (Perhaps that was just

my parents.) But in recent years, more hands on exhibits have been added.

One of Cranbrook's gems is the planetarium and the programs offered for children in its theater. Little kids love the Young Stargazers program, where planets and stars come out in the simulated night sky.

Cranbrook also hosts traveling exhibits in its downstairs exhibition area.

Hands-On museum

OK technically it's not a science center, but this Ann Arbor icon has some of the most intelligent and well-explained displays I've seen. Want to know how your vocal system works to produce various vowel sounds? There's a gizmo here that shows you.

Yes, there's also the science center requisite - the tornado machine - but tucked away in an unassuming corner is the best explanation of the Bernoulli effect (it's what helps make planes fly) that I've ever seen.

What the Hands On has above other centers is the ability to explain complex science principles in simple to understand terms.

The museum's come a long way since it was a fire house. And an addition was added last year. The expanded preschool area includes water play, a two tier house and a baby area with all the latest in politically correct infant stimuli. But judging from the swarm of little ones one recent Saturday, they could have made the area twice as large.

Great Lakes Science

Perhaps it just couldn't live up to my expectations, since I had heard so much about the great

Cleveland science center, but I was disappointed. I should say there are a great number of innovative displays designed to help children learn about the conservation of the Great Lakes and that's a good thing.

But so much of the equipment wasn't in working order, despite the fact that there seemed to be plenty of staff. You know that because they all walk around in white lab coats.

The center boasts some great live programs throughout the day, and staff members seem genuinely interested in helping kids make sense of what's what.

Still, so many of the displays were simply a matter of push a button, watch, and move on. It's no wonder that there was a half hour lineup for kids to take a turn at hitting a baseball to see their speed. At least it's something both interactive and personalized.

COSI-Toledo

COSI is my favorite science center - and not just because it has an awesome toddler area with a treehouse to climb and an ambulance to drive.

COSI knows how to make science fun. Though it often hosts national exhibits, the beauty of COSI is that you never get tired of its permanent installations. And there are displays that interest people of all age levels, including those in the early throes of high school.

For most kids, the area that's always a draw is the sports center, where they can test their speed and skills at running, throwing, cycling, and playing virtual volleyball. Granted, COSI could do a little more here explaining the physics and body mechanics involved with just a few well-placed posters, but it's not all just for fun. The Life Force area lets kids be junior detectives while explaining medical concepts.

While every science center is designed for learning and fun, I've concluded they're not all created equal.



Just my imagination: COSI-Toledo lets kids use building blocks to create all sorts of things, including a makeshift drum set.

Electrifying: It's hard to resist the urge to be a mad scientist when confronted with the Plasma Ball at Cleveland's Great Lakes Science Center.



CGS
COMMON GROUND
SANCTUARY

Art in the Park benefits Common Ground Sanctuary's crisis services for youths, adults & families.

SATURDAY, SEPTEMBER 22, 10-6
SUNDAY, SEPTEMBER 23, 10-5

- * OVER 170 ARTISTS
- * FOOD & ENTERTAINMENT
- * FREE ADMISSION
PLUS FREE PARKING IN CITY DECKS
(12 HOURS SATURDAY ALL DAY SUNDAY)
- * ONE OF THE TOP-RATED SHOWS NATIONWIDE
- * CHILDREN'S AREA:
ART AND ACTIVITIES
- * SILENT AUCTION

SPONSORED BY:

FOR INFORMATION, CALL 248-456-8150
WWW.COMMONGROUND.SANCTUARY.ORG

A Money Market Bonus account is a safe place for your money. Especially when the market has such sharp teeth.

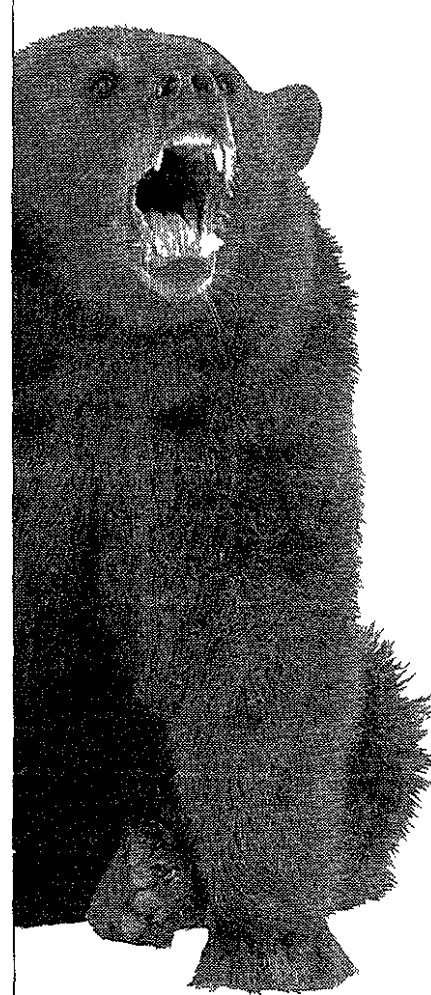

Bank One's Money Market Bonus

3.51%	3.30%
APY <small>on balances of \$20,000 or more</small>	APY <small>on balances of \$50,000 up to \$100,000</small>

Not only does our Money Market Bonus account give you immediate access to your money, but it's FDIC insured and has interest rates that are even higher than most money market accounts. At Bank One, there's nothing to be afraid of.

www.bankone.com

1-800-225-5623 for Personal Accounts
1-800-404-4111 for Business Accounts

Member FDIC. Available at Bank One. Michigan depositors only. Annual Percentage Yield (APY) shown is a valid through 9/16/01. Minimum deposit to open a Bank One Money Market Bonus account is \$500. Interest rates are variable and determined at Bank One's discretion. The current APY on balances up to \$1,000 is 1.10%, on balances of \$1,000 up to \$5,000 is 2.00%, on balances of \$5,000 up to \$25,000 is 2.40%, and on balances of \$25,000 up to \$50,000 is 2.90%. Fees could reduce earnings. Bank One reserves the right to limit the deposits to this account to \$1,000,000 per customer. Brokered deposits may not be accepted. Similar product available for businesses, but the APYs and balance limits may vary. © 2001 Bank One Corporation.

2 UNIQUE

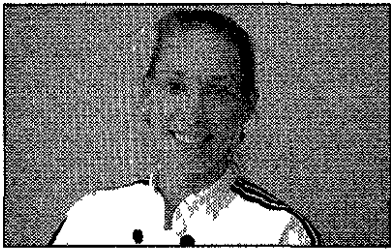

KELLI LEWTON

'Eat' your fruit and vegetables in unusual ways

Remember those words — "You have to eat your fruits and vegetables?"

Many health professionals suggest that we should eat seven servings of vegetables and two servings of fruit per day. It is common knowledge that on most days, the average American doesn't come close to that.

For centuries, fruit and vegetable juices were used for their therapeutic benefits, but that dietary choice was replaced with a lot of complicated recommendations from books, nighttime specials and talk shows. It would seem we are all just trying to figure out the big old jigsaw puzzle of nutrition.

No matter what your personal beliefs are, some of the most important core nutrition is alive in raw foods, juices and new, on the horizon, smoothies.

Many colors, content

Smoothies come in many shades of color and content. Some come alive with fun names like Peach-Keen,

Vaccinator, Love Potions and All Protein to name but a few. Smoothies are liquid concoctions containing raw fruits, vegetables or dairy products. They can include yogurts, ices, soy products, coffees and green teas. The possibilities are endless.

Smoothies and raw juices are often laced with "power-ups," such as ginseng, antioxidants, blue-green algae, protein powder and a ton of other herbs, minerals and powders. Smoothies are full of nutrients, and most are low to moderate in calories and fat.

They are assimilated quickly into the body system in their liquid form, which has huge diet and health benefits, and helps make smoothies a viable nutrition alternative for our fast-paced lives.

It's 'Super'

If you visit your local "true" smoothies and juice bars or pick up one of the better blender recipe books, you will stumble across listings of "Super Smoothies," boasting to do everything from cure your cold, freshen your breath, enhance your immune system, and even make your love life glow. Super Smoothies generally include additives such as ginseng, antioxidants, and protein powders, minerals and herbs.

I've been enjoying breakfast drinks every morning for nearly six years now (I call my smoothie the Over Thirty). It is loaded with protein powder, blue-green algae, vitamins, soy milk, and fresh fruit and juices. It helps, as the fast-paced restaurant world can often leave you on your feet for 10 hours at a time without even noticing that you have cooked all day but not attended to your own nutritional needs. Our smoothie bar serves up smoothies with the addition of an herb or supplement in one out of every two smoothie orders.

Smoothies are relatively easy to make at home. All you need is a blender and fresh ingredients, and your options are infinite. Smoothies

Please see 2 UNIQUE, D2

LOOKING AHEAD

What to watch for in Taste next week

- Rosh Hashanah
- National Breakfast Month

Learn ABCs of nutrition

Students can digest good eating habits



BY PEGGY MARTINELLI-EVERTS
SPECIAL WRITER

Packing your child's lunch for school can be thankless and daunting. Children are informed consumers and can be fussy about what they eat for lunch.

A great way to get children to eat their lunch is to include them in grocery shopping and food preparation. Sandy Rizzo of Rochester makes grocery shopping a family outing.

When we're in the market, my children help select cereals and other snacks, Rizzo said. This way they can enjoy treats, but in limited quantities.

Foods of choice

Let the children pick out the vegetables, fruits, grains, cheeses, meats and other lunch box ingredients.

Fourth-grade teacher Kathy Wochaska recommends keeping the size of the lunch in proportion to the size of the child.

"Some kids' lunches are huge," Wochaska said. "Parents would be shocked at what goes right into the garbage. They see an empty lunch box when the child gets home and assume their child ate everything." Whole pieces of fruit are generally too large for younger kids to finish. The fruit may be too difficult for small hands to peel or too large to eat.

Choose fresh fruits and vegetables that are cleaned and cut up, like carrot sticks or baby carrots, celery sticks, cucumber rounds, broccoli florets, green pepper rings, cherry tomatoes, apple wedges, melon balls, orange slices, or strawberries. Additional healthy choices include dried fruits, juice boxes, fruit cups and vegetable juice cocktails.

Last night's dinner is a great way to build today's lunch. Cold chicken, pizza, and salads are great for lunch and can be a creative way to use left-

overs. Also, last night's chicken can be turned into a tasty chicken salad or sandwich.

For Lake Orion resident Janet Barnard, chocolate is no longer a staple in the home. "Now that our children are getting older, we decided it was time to stop stocking up on junk food," Barnard said.

You can set a good example by eating nutritious foods yourself. Keep soda pop, sugary snacks, potato chips and other low nutrient foods out of sight of children.

Children do not like things that are too spicy, salty, soggy, squishy or tough. Also, those convenient all-in-one lunch meals are handy, but they are very expensive and often high in sodium and fat. Make the lunch yourself, and you'll spend less money and put together a more nutritious meal.

Let your kids know that a complete meal does not consist of a candy bar, potato chips and a pop. Ask your child to limit vending machine purchases and instead buy from the lunch line. Encourage them to choose more nutritious offerings, such as nuts, rather than chips or chocolate.

Keep food safety in mind by keeping hot foods hot and cold foods cold. Use a good quality Thermos for savory soups like chicken noodle or creamy vegetable, or macaroni and cheese and other hot foods. Use an ice pack or frozen juice box to keep meat, cheese and dairy foods cold.

Fun in a lunch box

You and your child will have fun making and eating these kid-friendly lunch box treats.

■ **Walking Sticks** Wrap slices of turkey or ham around a bread stick, carrot or celery stick. Wrap a pickle in a slice of ham.

■ **Pretzel Shish Kebobs** Alternate a frankfurter and cheese chunks on pretzel sticks.

■ **Fruit Kebobs** Alternate mini

marshmallows with fresh fruit chunks on skewers.

■ **Treasure Logs** Cut thin slices of meat and roll with a piece of cheese.

■ **Blue Suede Sandwich** Combine peanut butter with bananas, raisins, nuts, shredded apple or carrots. Spread onto bun, bread or bagel.

■ **Merry Go-Rounds** Spoon peanut butter on a thin apple slice.

■ **Jack O-Lantern Sandwich** Spread a round cracker, rice cake or piece of bread with cheese spread or grated carrots moistened with salad dressing. Decorate with raisin eyes and nose.

■ **Lotsa Pasta** Cook up fun shapes of pasta, toss in some cut up broccoli or shredded carrots, and mix in a little olive oil or Italian dressing.

■ **Trail Mix** Make your own using granola, mini chocolate chips, nuts, sunflower seeds, dried fruits, Goldfish crackers and pretzels.

■ **Peanutty rollups** Spread a lettuce leaf with peanut butter, place a carrot or celery stick in the middle, then, roll up the lettuce leaf.

Let your children know you are thinking about them by adding a love note, stickers or a special napkin to their lunch. Give kids information about food to inspire them to eat nutritiously. Explain how food makes their muscles and bones grow, and how it keeps them healthy.

Children should be empowered to make their own food choices and encouraged to eat a wide variety of foods.

Peggy Martinelli Everts, a Clarkston resident, is a registered dietitian and director of clinical operations for HDS Services, a Farmington Hills based food service and hospitality management and consulting company, specializing in food and nutrition service management for hospitals, long term care facilities, businesses, private clubs and private schools.

"PIGS" IN A BLANKET

1 package crescent rolls, pizza dough or buttermilk biscuits

Your choice of the following:
Lean ham slices
Muenster cheese or your favorite cheese
Mozzarella cheese, shredded
Tomato, thinly sliced
Scrambled eggs, cooked
Dill pickle slices
Bell pepper slices

Preheat the oven to 375°F. If using pizza dough, roll it out thinly and cut into 4-inch squares. If using biscuits, roll each biscuit until it is flat and about 1/4-inch thick. For crescent rolls, carefully unroll each triangle.

Place ingredients on the dough. Be sure they do not hang over the edges of the dough. Once assembled, place a second piece of dough on top and pinch to seal the edges. Transfer the "pig" to an ungreased cookie sheet.

Bake for 10-12 minutes until puffy and brown. (Pizza dough may take a little longer.) Serve immediately or cool, wrap, and refrigerate or freeze for later.

TURKEY STROLLERS

6 lawash, pita breads or flour tortillas
1/2 pound turkey breast, shaved
6 lettuce leaves, ridge removed
6 tomato slices
6 cucumber slices
12 sweet red pepper strips

Please see RECIPES, D2

Do you prefer Left Bank or Right Bank wines?

For two centuries the French region of Bordeaux has produced world-class red wines as blends of five varieties: cabernet sauvignon, merlot, cabernet franc, malbec, and petit verdot. But that's far too simplistic. Confirmed Bordeaux wine lovers know whether they are Left Bank or Right Bank.

What's the difference? Divided by two rivers, the Dordogne and the Garonne, Bordeaux literally has two banks, the Right with the major appellations of Pomerol and Saint-Emilion, and the Left, with the appellations of Saint-Estephe, Pauillac, Saint-Julien, and Margaux, generally grouped together under the name Medoc.

The two rivers make a significant impact on climate, soil, and grapes grown. Since the Medoc is also bordered on both sides by water, the Atlantic Ocean and the Gironde River, greater diversity is created. Wines from each bank have decided

personalities.

A recently released four-pack, Collection Baron Philippe of Bordeaux wines (about \$60) from Baron Philippe de Rothschild, has two Left Bank and two Right Bank wines that may help you to decide which bank you're on. Additionally, the four-pack is a savings of \$15 total, over buying each wine separately.

The similarity between all this and Left Brain and Right Brain is too close to ignore. If you don't already know, your answers to the following questions may help you to decide about your brain. We'll get to the wine in a minute.

■ Would you clear off a table before checking a French map to locate the Bordeaux region? Left yes, Right no



■ Do you remember what the sales person who sold you your last bottle of wine looked like? Left no, Right yes

■ Would you choose a wine because it had a catchy name or very attractive label? Left no, Right yes

■ If someone whistled a tune, could you guess what it is without hearing the lyrics? Left yes, Right no

What about the wines? OK, now you have a pretty good idea about your brain, so let's get back to the banks. From the Left Bank, the 1998 Baron Philippe de Rothschild Medoc is a blend of 55 percent cabernet sauvignon, 35 percent merlot, 5 percent cabernet franc, 3 percent malbec, and 2 percent petit verdot. It offers a rare opportunity to

Please see WINE D2

Wine Picks

We've tasted more Bordeaux wines from the 1998 vintage. Some are terrific bargains.

Since we're into this Left Bank/Right Bank thing, they are categorized that way and listed in our order of our preference. Sorry, Right Bankers, uh, right brainers, we have only one recommendation for you.

■ **Right Bank Chateau Puy-Blanquet** (\$20), a mellow style and good structure.

■ **Left Bank Chateau Meyney** (\$28) is typical of St.-Estephe with bigger fruit, more power, and ageability. Chateau Larose-Trintaudon (\$17) is softer on the palate with gobs of layered complexity. A great find at this price. Chateau Greysac (\$17) has excellent balance, but it's a little on the light side (however if you don't like big and bold, you'll really like it). Chateau Bel Air (\$15) has dark fruit complemented by intriguing olive notes and a nice grip in the finish.

Grill yellowfin tuna, then enjoy with salad

BY THE ASSOCIATED PRESS

Yellowfin tuna has pale-pink flesh and a more intense flavor than albacore. It's used in a low-fat recipe for grilled tuna featured in "Weight Watchers Great Cooking Every Day" (Hungry Minds, 2000, \$24.95).

GRILLED YELLOWFIN TUNA WITH CITRUS SALAD

- 1/2 teaspoon arrowroot
- 1/3 cup low sodium vegetable broth
- 1 medium pink grapefruit
- 1 medium orange
- 1 tablespoon minced jalapeno pepper (wear gloves to prevent irritation)
- 1 tablespoon roasted peanut oil
- Freshly ground pepper
- 1/4 teaspoon salt

- 1 pound trimmed yellowfin tuna fillet cut into 4 pieces
- 1/2 teaspoon finely grated lemon zest
- 1/2 teaspoon finely grated lime zest
- 1 cup very thinly sliced fennel bulb
- 1 red onion very thinly sliced
- 2 teaspoons chopped fennel tops

Dissolve the arrowroot with 2 teaspoons of the broth in a small bowl. Bring the remaining broth to a boil in a small saucepan. Stir in the arrowroot mixture and cook, stirring, until thickened, about 30 seconds. Remove from the heat and let cool slightly.

Using a sharp paring knife, slice away the top and bottom ends of

the grapefruit. Place on a cutting board on end and slice the rind away, removing all traces of pith. Working over a large bowl to catch the juices, cut the grapefruit sections out from between the membranes, letting each one fall into the bowl as you cut it free. Discard any seeds. Repeat with the orange.

Add the jalapeno and the juice from the citrus sections to the thickened broth. Whisk in the oil and season with pepper.

Spray the grill rack with nonstick spray and prepare the grill, or spray a nonstick ridged grill pan with nonstick spray and set over medium high heat.

Season the tuna with the salt and pepper. Grill the fish 5 inches from the heat, until opaque in the center, 2 to 3 minutes per side.

Meanwhile, warm the dressing. Add the grapefruit and orange sections and the lemon and lime zest, warm through (do not stir or the grapefruit will break apart). Divide and arrange the fennel on each of four plates and top with the onion. Arrange the citrus salad next to the fennel. Drizzle the plates with the dressing and sprinkle with the chopped fennel tops. Makes 4 servings.

WHAT'S COOKING

Send items for Taste calendar at least two weeks in advance of event to Ken Abramczyk, Taste Editor, Observer Newspapers, 36251 Schoolcraft, Livonia, MI 48150 or e-mail kabramczyk@oehomecomm.net. Send files in a text format.

FARMERS MARKETS

WILSON BARN

The Friends of Wilson Barn will host the 12th annual Farmers Market 8 a.m.-3 p.m. every Saturday until Sept. 30 at the Wilson Barn on the northeast corner of West Chicago and Middlebelt in Livonia. The market offers fresh produce, honey and a variety of crafts. Vendors pay \$10 a week for a 10-foot by 20-foot space. WIC Fresh Start coupons accepted. For information, call (734) 427-4311 or (734) 522-5039.

GREENMEAD

Greenmead's Country Market offers produce and items from farmers, gardeners, craftsmen, beekeepers and horticulturalists at Greenmead Historical Park, 8 Mile and Newburgh roads in Livonia 9 a.m.-2 p.m. on Thursdays until Oct. 11. Reserve a 10-by-20-foot space now, \$10 weekly or \$100 seasonally. Applications are available at the Greenmead

office at (248) 477-7375.

PLYMOUTH

Produce is available 7:30 a.m.-12:30 p.m. Saturdays through October at The Gathering on Penniman Avenue at Main Street in downtown Plymouth. Call (734) 453-1540.

NORTHVILLE

Market items are available 8 a.m.-5 p.m. Thursdays through October at the Northville Downs parking lot at 7 Mile and Sheldon in Northville. Call (248) 349-7640.

SCHOOLCRAFT COLLEGE

CONTINUING EDUCATION

Schoolcraft College begins another semester of continuing education classes in the culinary arts department 6-9 p.m. Tuesday, Sept. 11, when instructors will discuss vegetables and how to prepare them. Other evening classes in September include Pasta Cookery, Mondays, Sept. 17 and 24, and Basic Cooking Techniques for fish and shellfish, Tuesdays, Sept. 18 and 25. Classes scheduled in October are *Party 101: Basic Essentials to Create a Multitude of Dishes*, Tuesdays, Oct. 2 and 9, *Theme Dinners with the Chefs*, Thursday, Oct. 4, *Cooking Light*, Saturday, Oct. 6, *Thai and Vietnamese Cuisine*, Monday, Oct. 8,

Beyond the Basics: The Mediterranean Pantry, Tuesday, Oct. 16 and Beyond the Basics: The Italian Pantry, Tuesday, Oct. 23. For more information, call (734) 462-4448.

CULINARY EXTRAVAGANZA

Enjoy food from some of the area's finest restaurants at Schoolcraft College's Culinary Extravaganza 2001, 2-5 p.m. Sunday, Sept. 23 at the Waterman Campus Center, 18600 Haggerty, between Six and Seven Mile roads in Livonia. The event is the main fund-raiser for the Schoolcraft College Foundation. Proceeds contribute to student scholarships. Tickets are \$40 per person, two for \$75. Raffle tickets are \$5 or three for \$10. Both can be purchased by calling Schoolcraft's Development Office at (734) 462-4670. Visa, MasterCard, Discover and checks are accepted.

TREE HOUSE

The Tree House, 22906 Mooney, north of Grand River and one block west of Orchard Lake Road in Farmington, offers a raw living food course 7-9 p.m. starting Sept. 12, for seven consecutive Wednesdays. The vegetarian deli offers organic foods. The class costs \$95. Call (248) 478-0624 for information.

Mike's Marketplace

Your Meat & Deli Supermarket

OPEN MON-SAT 9-9 SUN 9-7

38000 Ann Arbor Rd. Livonia (734) 464-0330

"GREAT DEALS for GREAT MEALS"

(Sale starts Monday 9 a.m.)



FRESH GRADE A • 8 PC. CUT-UP FRYING CHICKEN

Limit 3 Pieces Only **77¢** LB.



MIKE'S FAMOUS STOREMADE STUFFED PORK CHOPS

Oven Ready! Only **\$1.77** LB.



USDA • BONELESS • ROLLED SIRLOIN TIP ROAST

Only **\$1.77** LB.



FRESH • STOREMADE • BONELESS STUFFED CHICKEN BREAST

Oven Ready! Only **\$1.77** LB.



USDA SELECT BONELESS SIRLOIN STEAKS

3-Steak Family Pack Only **\$2.77** LB.



"Fresh from the barrel" CENTER CUT CORNED BEEF BRISKETS

Only **\$3.77** LB.



MILD • DELICIOUS ORANGE ROUGHY FILLETS

Only **\$5.77** LB.

ANY SIZE PACKAGE...



FRESH GROUND CHUCK

Only **\$1.69** LB.



FRESH GROUND ROUND

Only **\$1.99** LB.



FRESH GROUND TURKEY

Only **\$1.69** LB.



FRESH GROUND SIRLOIN

Only **\$2.49** LB.

Summer Favorites!!



WESTBORN MARKET

<p>California SUGAR SWEET CANTALOUPE</p> <p>2/\$3.00</p>	<p>Michigan FRESH, CRISP CUCUMBERS</p> <p>4/\$1.00</p>
<p>Washington SWEET & CRISP GALA APPLES</p> <p>99¢ Lb.</p>	<p>Washington DELICIOUS BARTLETT PEARS</p> <p>69¢ Lb.</p>
<p>Colorful JUMBO HARDY MUMS</p> <p>3/\$15.99</p> <p><small>\$5.99 ea</small></p>	<p>Great Time to Plant! NURSERY STOCK</p> <p>50% OFF</p> <p><small>Fresh Cut Roses \$6.99 dozen</small></p>
<p>U.S.D.A. Choice BONELESS CHUCK ROAST</p>	
<p>GROUND ROUND</p> <p>\$1.89 lb.</p>	<p>\$1.99 lb.</p>
<p>BONELESS PORK ROAST</p> <p>\$3.69 lb.</p>	
<p>Healthy Choice HONEY TURKEY</p> <p>\$5.99 lb.</p>	<p>Hoffmans SUPER SHARP CHEESE</p> <p>\$4.59 lb.</p>
<p>Krakus POLISH HAM</p> <p>\$4.99 lb.</p>	
<p>COCA COLA PRODUCTS</p> <p>99¢</p> <p><small>2 Ltr. + dep.</small></p>	<p>GREAT CATCH FRESH CATFISH</p> <p>\$4.99 lb.</p>
<p>BAREMAN MILK</p> <p>\$1.99</p> <p><small>1 Gallon except chocolate</small></p>	

14925 MIDDLEBELT LIVONIA • 734-524-1000
Just South of Five Mile • (on the west side)
www.westbornmarket.com
We reserve the right to limit quantities. Prices good through Sept. 12, 2001.

Recipes from page D1

- 2 green onions, finely sliced
- 1/4 cup alfalfa sprouts
- Ranch or cucumber dill dressing

To assemble the sandwich, lay out the lavash loaves, pita bread or flour tortillas. Spread the lettuce leaf on the lavosh/pita/tortilla and place all other ingredients in a line from top to bottom, just slightly to one side of center.

Spread 1 to 2 tablespoons of dressing alongside the other ingredients from top to bottom. When all ingredients are in place, roll from the smallest side, tucking in as you roll it to the larger side. Cut size to match appetite. Roll in waxed paper and twist ends. Serve cold. Recipes courtesy of HDS Services of Farmington Hills.

2 Unique from page D1

would be a wonderful way to send our children's high sugar breakfast cereal packing, but your kids may not even realize these health benefits. (They would most likely trot off to school with stories of how their parents went 'over the edge,' allowing them to have fun fruit milk shakes for breakfast!)

However you choose to serve it up or buy it, smoothies pack those needed fruits, vegetables and dairy products. They are a good thing and good for you. Perhaps the memories for our

children will include the phrase "you have to eat or drink your fruits and veggies." Who knew getting our fruits and vegetables could tickle our tongues, too!

Chef Kelli L. Lewton is owner of 2 Unique Caterers and Event Planners in Bloomfield Hills and Aunt Olive's Good Food 2 Go in Birmingham. Lewton is a graduate of Schoolcraft College's Culinary Arts program. Look for her column in Taste on the second Sunday of the month. See recipes inside.

Wine from page D1

taste a Bordeaux Five and get a handle on your bank preference with a wine that can be enjoyed young as well as aged a few years.

Also from the Left Bank, the 1998 Baron Philippe de Rothschild Pauillac is a blend of 70 percent cabernet sauvignon, 20 percent merlot, and 10 percent cabernet franc. Pauillac is home to three of the world's most famous first-growth chateaux: Mouton Rothschild, Lafite-Rothschild, and Latour. Best enjoyed five to eight years post-vintage, you're going to want to taste this wine now to determine your bank preference.

Moving to the Right Bank, the 1999 Baron Philippe de Rothschild Pomerol is drinking well now, but will age. Brimming with opulent fruit as a blend of 70 percent merlot, 20 percent cabernet franc, and 10 percent cabernet sauvignon, it is a clear departure in the mellow spectrum from the Medoc wines which are leaner.

If you're watching the percentages in the blend, you're catching on to this Left Bank/Right Bank thing. The 1999 Baron Philippe de Rothschild Saint-

Emilion (Right Bank) with 80 percent merlot, 12 percent cabernet sauvignon, and eight percent cabernet franc is fruit-laden, balanced, and elegant.

Anything match up? Purchase the four-pack Collection and have some fun. Lately, wine is getting all too stuffy. Invite a few friends to dinner. All the wines will complement red meat, but differently. If you're vegetarian, kick up some vegetables with a great marinade, then grill them to caramelize the sugars for added flavor that will better match them to the wine.

First, have each person at the dinner party determine if he/she is left brained or right brained. Then proceed to Left Bank and Right Bank. Do they correspond? If not, hey, variety is the spice of life. The most important thing is, did you have some fun with wine?

The Healds are Troy residents who write about wine, spirits, food, and dining for the Observer & Eccentric Newspapers. To leave them a voice mail message, dial (734) 953-2047, mailbox 1864#.

Read At Home Thursdays



COMPUTER EXPRESS

Brings you
Reliable Motorcoach Service to

CASINO WINDSOR™

DEPARTURES FROM:
Bloomfield • Farmington • Novi
Hamtramck • Madison Heights • Southfield

5 DAYS A WEEK!
(Mon.-Fri.) Starting Tues., Sept. 11th

2 persons \$5.00 {including \$15.00 Meal Voucher or \$10.00 in coins}

Call 1-800-290-2957

Service provided by Commuter Express and is not affiliated with Casino Windsor. Trademark of the Ontario Lottery and Gaming Corporation used under license.



Apple crisp: You can make great, low-fat desserts with apples. The next time you go to a potluck dinner, bring an apple crisp.

AMERICAN INSTITUTE FOR CANCER RESEARCH

Enjoy a crisp fall with apples

Nothing tastes better than a crisp, juicy, crunchy apple when you're out hiking in the brisk autumn air or relaxing with a good book.

Whether you are picking your own apples in an orchard this fall or buying them at the market, this is the season to load up. The variety of ways you can use apples is endless - from smoothies and snacks to salads, side dishes, sauces and even entrées.

Americans can't seem get enough of this fiber-filled, nutritious fruit. Cultivated since ancient times and brought to the United States by the Pilgrims in 1620, today over 7,000 varieties of apples are grown in the United States - unfortunately, few of them are found in most supermarkets.

Red Delicious, the most popular variety, is great for eating out of hand or in uncooked dishes. Add sliced apples to low-fat yogurt or slip them into a sandwich. For a child's snack, slice an apple in half, scoop out the core and add peanut butter. Or make a smoothie by pureeing apples in a blender with bananas, juice and ice.

Combine sliced apples with canned sliced beets in a salad.

Mix chunks of apples with any mixture of leafy greens and drizzle with your favorite low-fat dressing. Add chopped apples to a pilaf or cooked mixed vegetable dish just before serving.

Other types of apples are better suited for cooking and baking, like Rome Beauty, Braeburn, Jonathan, Empire, McIntosh, Granny Smith and Golden Delicious. Add some during the last few minutes of cooking a stir-fry or a curry. You can also make great, low-fat desserts with these apples. Next time you go to a potluck dinner, bring an apple crisp and watch your friends indulge in a dessert that's a treat for their health as well as their tastebuds.

3/4 teaspoon ground nutmeg
3/4 tablespoons cold butter cut into small pieces

Preheat oven to 375° F. Coat 8 inch square baking dish with cooking spray.

Combine apples, raisins and apple juice in bowl, toss well and set aside. In another bowl, combine flour, rolled oats, brown sugar, cinnamon and nutmeg. With pastry blender or knife and fork, cut in butter until mixture resembles coarse meal.

Transfer apple mixture to baking dish. Sprinkle flour mixture evenly over surface. Lightly coat top with cooking spray.

Cover and bake 30 minutes. Uncover and bake for 20 minutes more or until apples are tender. Remove from oven and let stand on wire rack at least 20 minutes. Cut into squares and serve warm or at room temperature. Makes 6 servings.

Nutritional information per serving: 196 calories, 2 g fat (1 g saturated fat), 40 g carbohydrate, 2 g protein, 4 g dietary fiber, 20 mg sodium.

Recipe courtesy of the American Institute for Cancer Research

APPLE CRISP

Canola oil cooking spray
4 Granny Smith apples cored and cut into thin slices or bite size pieces
1/2 cup raisins
3 tablespoons apple juice
1/4 cup whole wheat flour
1/4 cup old fashioned rolled oats
1/4 cup brown sugar
3/4 teaspoon ground cinnamon

Pump up nutrition in smoothies

Recipes courtesy of Kellie Lewton. See related column on Taste front.

Pump up the nutritional value of your smoothie with any of the following additives: 1 tablespoon wheat germ, 1/4 cup bran cereal, 1 tablespoon protein powder, tofu, milk (substituted for part of juice) or lemonade, blackstrap molasses (extra iron), brewer's yeast (protein), pirulina or chlorella (supplements), Royal jelly or green tea.

GIDGET'S GO-GO CREAM

1 1/4 cup frozen Yogurt
10 ounces ice
3/4 cup orange juice
1/2 teaspoon vanilla
1 banana
2 ounces peaches
2 ounces oranges

Blend ingredients and serve

THE "OVER THIRTY"

1/2 cup soy milk
1/2 cup very berry soy milk
12 ounces ice
1/2 banana
1 ounce algae

1 ounce wheat grass
2 tablespoons flax seed oil
2 tablespoons antioxidants
2 tablespoons protein powder

Blend ingredients and serve

TEA-LICIOUS

1/2 cup soy milk
1/2 cup green tea
12 ounces ice
2 tablespoons honey
2 ounces orange
1 ounce peaches

Blend ingredients and serve

Bananas, dried plums and peanut butter team up

BY THE ASSOCIATED PRESS

Making sandwiches at high speed can still get results that rise above routine.

Without stretching the pantry budget, have a bit of fun with easy but imaginative combinations of ingredients. Try this one for the lunch boxes or for a fast, nutritious snack for anyone (and remember that dried plums are what you used to call prunes).

PEANUT BUTTER, BANANA AND DRIED PLUM SANDWICHES

(Preparation time 10 minutes)
4 slices whole wheat bread toasted
1/4 cup peanut butter
1 medium banana sliced
1/4 cup (about 2 ounces) quartered pitted dried plums
2 tablespoons honey
1/8 teaspoon ground cinnamon (optional)

On each of two bread slices, spread 2 tablespoons peanut butter. Top with banana slices and dried plums. Mix honey with cinnamon if desired. Drizzle honey over dried plums. Top each with remaining bread slices.

Makes 2 sandwiches

Nutrition information per 1 sandwich serving: 688 cal, 18 g fat, 0 mg chol, 423 mg sodium, 118 g carb, 9 g fiber, 16 g pro.

(Recipe from California Dried Plum Board)

We Have All Your B-B-Q Favorites!

Visit Our Website at: www.vintage-picnic.com

Picnic Basket MARKET PLACE
49471 Ann Arbor Rd.
(W. of Ridge)
459-2227

VINTAGE MARKET
29501 Ann Arbor Trail
(Just W. of Middlebelt)
422-0160
We now carry U.S. Grade A Amish Chicken

SALE STARTS MONDAY

Food Stamps & All Major Credit Cards Accepted Prices effective September 10 - September 16, 2001

<p>Hamburger from Ground Sirloin 5 lbs. or More Only \$1.99 LB</p>	<p>USDA Boneless Delmonico Steaks Only \$5.99 LB</p>	<p>US Grade A • Boneless • Skinless Chicken Breast Only \$1.99 LB</p>
<p>Lean & Meaty XXX Spare Ribs Only \$2.49 LB</p>	<p>USDA Boneless Rump Roast Only \$2.49 LB</p>	<p>US Grade A • Boneless • Butterfly Pork Chops Only \$2.99 LB</p>
WORLD'S BEST PARTY SUBS • CATERING • PARTY TRAYS • TOP QUALITY PIZZAS		
<p>Grabel Premium Corned Beef Only \$3.99 LB</p>	<p>Kowalski • Imported Polish Ham Only \$3.79 LB</p>	<p>Sour Cream Mac & Cheese Only \$2.29 LB</p>
<p>Our Own Rotisserie Roast Beef Only \$4.39 LB</p>	<p>Hoffmans Famous Dairy Fresh Super Sharp Cheese Only \$3.99 LB</p>	<p>12 Pack Bottles Only \$11.99 Tax & Deposit</p>
<p>Kowalski's Finest • Regular or Garlic Bologna Only \$2.99 LB</p>	<p>Real Tiger Cheese Only \$3.79 LB</p>	<p>Bud & Bud Light Budweiser \$11.99 Tax & Deposit</p>

Observer Fall Reader Promotion

READ YOUR HOMETOWN OBSERVER AND WIN!

When you subscribe to your hometown Observer now through September 30 you could win one of these exciting prizes!

- * **A WEEKEND** for two in Stratford, Ontario (October 6-7 only) with accommodations at The Victorian Inn, tickets to see Twelfth Night and Inherit the Wind and lunch at the exclusive Church Restaurant
- * **FOUR TICKETS** to any Ringling Bros and Barnum & Bailey Circus™ performance Wednesday through Sunday October 7-11 in Joe Louis Arena
- * **FOUR TICKETS** to any Disney on Ice Presents Three Classics featuring Walt Disney's Snow White and the Seven Dwarfs, 101 Dalmatians and Disney's The Little Mermaid playing Joe Louis Arena, Wednesday through Sunday, November 7-11
- * **FOUR VIP TICKETS** to any regular season home game of the Plymouth Whalers at Compuware Sports Arena in Plymouth and a \$50 gift certificate for dinner at the Ginopolis Parthenon restaurant located inside the arena

Entering is so easy!
Just call an Observer Customer Service Representative today to subscribe or renew and tell us you want to be part of **The Observer Fall Reader Promotion!**
Be sure to ask about our other reader premiums

Call The Observer
734-591-0500

(6 month subscription \$25.50 annual subscription \$51.00 Senior citizen rates available
Payment must accompany order Promotion ends Sept 30 Drawing will be held Oct 1
Winners will be notified by telephone Oct 1)

JOE'S PRODUCE

Michigan's Finest

Dole Italian Salad Mix
\$1.99 10 oz. bag

Dole Caesar Salad Mix
\$1.99 7.5 oz. bag

The Best of Michigan's Product!

<p>Michigan Locally Grown McIntosh Apples 69¢ lb.</p>	<p>California Ripe & Sweet Raspberries \$1.99 each</p>	<p>Michigan Red Haven Freestone Peaches 79¢ lb.</p>
<p>Michigan Locally Grown Tomatoes 69¢ lb.</p>	<p>Jumbo Michigan Eggplant 49¢ lb.</p>	<p>Michigan Super Sweet Variety Sweet Corn 10/\$1.99</p>
<p>Michigan All Purpose White Potatoes 99¢ 10 lb. bag</p>	<p>Michigan 1/2 Peck Tomatoes \$4.99</p>	<p>California Sugar Sweet Carrots 99¢ 3 lb. bag</p>
<p>Michigan Locally Grown Hardy Mums \$4.99 8 oz. pot.</p>	<p>Michigan 1/2 Peck Tomatoes \$4.99</p>	<p>Second Season Pansy Plant them this Fall, they will flower again in the spring</p>

Prices Good Through Sept. 13, 2001

SHOP JOE'S PRODUCE
for the freshest variety of fruits & vegetables!
— Proudly Serving Livonia Since 1945 —

33152 W. Seven Mile Livonia, Michigan 48152
(248) 477-4333

MEDICAL BRIEFS

Healthy hearts

"Good" and "bad" cholesterol, heredity, stress, diet, exercise - how do these factors impact your heart?

St. Mary Mercy Hospital in Livonia will offer several classes related to cardiovascular health from Sept. 20 to Nov. 29 to clarify the overabundance of heart health information available to consumers. The first class, "Take it to Heart," held from 7-9 p.m. in West Addition A, will assist in understanding and identifying personal risk factors for developing heart disease.

There is a fee. Participants can pre-register by contacting the Community Outreach Department at (734) 655-8940 or 1-800-494-1650 (out-of-area callers).

Volunteers needed

The American Cancer Society is looking for individuals interested in the fight against breast cancer to volunteer for the fourth annual "Making Strides Against Breast Cancer Walk" Saturday, Oct. 13, at Detroit's Belle Isle Park. A variety of volunteer opportunities are available. Call 1-800-ACS-2345.

Prescription program

Starting Oct. 1, 2001, the Elder Prescription Insurance Coverage will take effect. As of Sept. 20, 2001, the Michigan Emergency Pharmaceutical Program for Seniors will no longer exist.

The EPIC is a new state program that will provide a 12-month prescription benefit for eligible and enrolled low-income seniors, allowing more complete coverage than was previously available. The initial focus of EPIC will be on current MEPPS recipients and current Senior Prescription Drug Tax Credit Beneficiaries. However, other qualified older adults will be able to apply for assistance once these two priority groups have completed enrollment.

EPIC applications currently are being mailed out to MEPPS clients who have participated in MEPPS within the last 12 months, followed by Senior Prescription Drug Tax Credit Beneficiaries. Assistance is available to answer questions and fill out applications by appointment at the City of Westland's Friendship Center.

Open enrollment for all other potential participants will begin Jan. 1, 2002. Call (734) 722-7632.

Breast Health Expo

Saint Joseph Mercy Health System will present its annual Breast Health Expo 5:30-8 p.m. Wednesday, Oct. 3, at the Education Center at St. Joseph Mercy Hospital, 5301 East Huron River Drive, Ypsilanti.

A special presentation by Dr. Janet Osech, a full professor of surgery and epidemiology at Michigan State University who has spoken extensively on breast cancer throughout the country, will focus on medical education and public policy. She will discuss common concerns and misconceptions.

- The need for screening when there is no family history of breast cancer

- Why women should wait until age 40 for initial screening

- Differences between breast preservation treatment and mastectomies

- The need for radiation with a lumpectomy

- The need for mammograms for women over the age of 70

- Why the machine must squeeze so hard during mammograms

The SJMHS Breast Health Expo will also include health exhibits, door prizes and light refreshments. Admission is free, but reservations are required. Call the Saint Joseph Mercy HealthLine at (800) 321-2211.

We want your health news

There are several ways you can reach the Observer Health & Fitness staff. The Sunday section provides numerous venues for you to offer newsworthy information including Medical Databook (upcoming calendar events), Medical Newsmakers (appointments/new hires in the medical field) and Medical Briefs (medical advances, short news items from hospitals, physicians, companies).

We also welcome newsworthy ideas for health and fitness related stories. To submit an item to our newspaper you can call, write, fax or e-mail us.

CALL US:

(734) 953-2128

WRITE US:

Observer & Ecosonic Newspapers
(Specify Databook, Newsmakers or Briefs)
Attn: Renée Skoglund
36251 Schoolcraft Road
Livonia, MI 48150

FAX US:

(734) 591-7279

E-MAIL US:

rskoglund@oe.homecomm.net



Perfect shape: Susan Brady holds son Matthew as U-M orthotist Ammanath Peethambaran, who led the development of the Michigan Cranial Helmet, fits Matthew with his head-shaping baby helmet. Baby Matthew will wear the helmet 23 hours a day.

PHOTOS COURTESY OF UNIVERSITY OF MICHIGAN

RESHAPING soft skulls

BY MAUREEN MCGERTY
SPECIAL WRITER

One Michigan baby girl recently was diagnosed with a common positional head deformity and treated at the University of Michigan Health System's Orthotic & Prosthetic Center.

The flattening of Alexandra Case's head and her preference for sleeping on her right side led her mother, Cheryl Case of Auburn Hills, to seek medical assistance. Because the baby's skull and neck muscles were affected by her sleeping position, a diagnosis of torticollis was reached. The condition was corrected when Alexandra was fitted for a bi-valve cranial helmet developed by the center in Ann Arbor.

"She's doing really well with it," said Cheryl Case. "She's doing really well. It doesn't seem to bother her at all. She looks cute, like she's getting ready to play hockey."

Last spring, the Food and Drug Administration okayed the Michigan Cranial Helmet, a customized headgear designed for newborns and infants with cranial, or skull, malformations. Developed by the University of Michigan Health System and manufactured by Ann Arbor-based Danmar Products Inc., the bi-valve, or dual-sided, helmet guides the reshaping of a baby's skull.

Problems

Many common skull problems result from sleep or womb position, delivery, surgery or injury. The good news is they can be corrected.

"Because the bones have not hardened, there is still time," said U-M board-certified Ammanath Peethambaran, who led the helmet's design and development for the Orthotics & Prosthetics Center.

Pediatricians alert parents to babies' misshaped heads

Babies' skulls are soft and moldable through the first year, and sometimes beyond, when head bones begin to harden and fuse along junctures, or sutures, between the several bones of the skull.

Both fontanelle or "soft spots" - one front and one rear - vary in terms of how quickly they fuse. The posterior (rear) fontanelle may fuse before a baby is born or within one month. The anterior (front) fontanelle fuses in eight to 16 months.

"When a baby is born, there's going to be a lot of molding and adapting of the head shape to the birth canal," said Dr. Silvia Operti Considine, a pediatrician with Botsford General Hospital in Farmington Hills.

"As a pediatrician, I need to know if a birth was vaginal or a C-section. If there was a vacuum or forceps involved, it may make a difference on the head shape," she added. "Depending on the size of the birth canal, the head size has to decrease. The sutures are open and this gives flexibility to get smaller or narrower. You also have the pressure of the birth canal, be it a long or short delivery."

A newborn's skull may be altered during a hard delivery by the use of a vacuum, causing a localized hemorrhage occurring between a suture. "These are things temporarily changing the shape of a head. Keep an eye on them. As time goes by, even in the first two weeks, they're going to disappear."

An infant's preference for the right or left side is tied in with how feeding takes place. "If mom tends to prefer one side to another, the kids tend to have preference for positioning the head in one way, and flattening of the skull may occur." This may carry over to how a baby chooses to sleep.

The key to understanding the seriousness of skull malformations is symmetry of features.

"If you look from the top of the head and find a flattening of the frontal right part, you'll have a symmetrical flattening



Making the helmet

Development of what's now known as the Michigan Cranial Helmet began in 1994 at U-M's Orthotic and Prosthetic Center. To date, more than 1,200 infants have been fitted for the helmet.

"We take a mold of the child's head," said Mark Taylor, a board-certified prosthetist/orthotist who assisted Peethambaran with the helmet's development. "We modify that mold to make it symmetrical so that the child will grow into the mold."

Each bi-valve, or two-piece, helmet, which weighs just a few ounces, is custom-fit for each infant. Because it's made in two pieces, the helmet can be widened to allow for growth.

"They're made out of eighth-inch co-polymer, which is a plastic," Taylor said. "We use a quarter-inch alplast lining. Alplast is a foam padding that lines the helmet."

of the UMHS Department of Physical Medicine & Rehabilitation. When the child is born the head seems to be in a perfectly round shape, but once the child lays in the bed or on a surface, you may see that one area is flattened. It's like a balloon filled with water."

Once a helmet has been prescribed by a pediatrician, parents or caregivers may schedule an appointment at the center. After a mold is taken, it takes about a week to complete the fitting.

We've had patients as young as 12 weeks and as late as 12 months, Taylor said. Parents may expect a more symmetrical development of the skull. We can see change when an infant has had a growth spurt. If the child doesn't grow much, we'll see little change. Not all infants are the same.

If you put one of our helmets on a deformed head, the skull will grow into the void area near where the flatness is and then take the shape of the outer shell provided by the helmet, he added. The helmet does not apply any force on the head, but allows the skull to grow within the pre-shaped helmet."

Correcting other problems

Positional head deformities create cosmetic differences as well as face and jaw problems. These, in turn, may be responsible for eating and breathing difficulties that can occur as a child ages. Once skull bones harden and fuse together, their shape and position must undergo surgical correction.

Other FDA-approved helmet designs have been developed in Florida and Arizona.

U-M's bi-valve design is unique; other designs use a band style that fits an infant's head. Early research and development of similar projects began in the 1970s. Total cost of the Michigan Cranial Helmet is \$1,500 and includes evaluation, casting, lab work, fittings and follow-up visits. Be sure to check with your insurance provider about coverage.

Parents who have a prescription from a pediatrician or specialist may call the UMHS Orthotic & Prosthetic Center at (734) 973-2400.

of the left occipital part. It will be the shape of a parallelogram. These are things we monitor," Operti Considine said. Watch for eye and ear symmetry, also, she advised.

No need for alarm

Not every baby needs a molding or shaping helmet. Most flat spots go away on their own.

To help prevent sudden infant death syndrome, pediatricians advise parents to place sleeping infants on their backs, instead of their tummies. Babies who sleep on their backs may develop flat patches on their heads. As public awareness converges on both soft skull flattening and sudden infant death syndrome, many parents may be in a quandary about how to position their sleeping infants.

"If you bottle feed your baby with your left arm and you notice the right side of the head is flattening, alternate arms. You can also position a baby's head while sleeping to one side for one week and to the other side the next week."

"You can always have them facing the outside of the crib. As they get older, they tend to look to the side where there's more stimulation. Look for an improvement around six months."

More serious issue

If a more serious problem presents, the pediatrician will refer the infant to a specialist after a skull X-ray, MRI or both have been done. Sight, hearing and breathing problems may be involved.

Pediatric neurosurgeons and plastic surgeons then may become involved. Usually, it's a specialist who refers a patient to a clinic such as the UMHS Orthotic and Prosthetic Center to be fitted for a type of molding helmet if needed.

"Cranial stenosis is a relatively uncommon problem for the severe type, I think, one for every 2,000 live births," said Dr. Mark C. Watts, a pediatric neurosurgeon at Henry Ford Hos-

pital in Detroit. Most of the time, in cases where patients are thought to have cranial stenosis, it's really a positional problem."

Infants before they develop, can't move or support their heads or roll from side to side. Until they reach a certain stage of development, they're often lying on one side of their heads for a period of time, he said, and it tends to flatten.

Once mobile, with stronger neck muscles, babies find new positions, and the flattened spots reshape themselves. Positional flattening generally rights itself without intervention.

How can parents and caregivers discern between a common instance of flattening and a more serious problem?

"It's often difficult for parents and pediatricians to tell the difference," Watts said. "You often look for a couple of different things: the cheek is somewhat flattened, the nose deviates and the child just doesn't look symmetric in terms of the position and structure of the eye and nose."

Watts occasionally prescribes a shaping helmet for a patient who needs to have minor changes made in the shape of his or her head.

"Helmets can help round things out and make the child's head quite normal," Watts said. "At Henry Ford, we use them infrequently. We tend to let nature take its course. There's only a small number of kids who need helmets."

When a parent, caregiver or pediatrician suspects a problem, it's a good idea to regularly photograph your infant in the event comparisons need to be made by a physician or specialist in consultation. It's also a good idea, Watts said, to monitor the circumference of a baby's head during well-child check-ups.

Follow your child's milestones, Watts said. "Jot down when your child attempts to crawl, roll over, smile and coo and track with the eyes around the room."

If you observe a characteristic that seems different, check with your physician.

The ABC's of getting your ZZZ's

Good sleep hygiene for kids means good health

What better time than late summer or early fall to take a few tips from pediatric sleep experts and start the school year off on the right note? Now's the time to help children and adolescents make gradual changes to improve their sleep habits — and to take note of whether they have sleep problems that may warrant special attention.

Says Timothy Hoban, a pediatric sleep specialist in the Division of Pediatric Neurology at the University of Michigan Health System, the issue of "sleep hygiene" is crucial year round for kids, whose daytime alertness, school performance, growth and development can suffer without proper sleep. But many children and teens experience sleep disturbances that go uncorrected.

"If you look at the spectrum of problems that can affect sleep, I think it's probably the rare child who doesn't have occasional problems with insomnia, bedtime struggles, waking up groggy or oversleeping," he says. "It's a little tougher to estimate how frequent the more severe problems are," he adds, but if observant parents and doctors catch them, the disorders can often be treated successfully.

Parents of children with developmental issues, such as attention deficit hyperactivity disorder, mental retardation and autism especially need to pay attention to their children's sleep patterns, which are more likely to be disrupted because of their condition or medication, Hoban says.

But all parents should be aware that sleep problems aren't limited to adults. At the U-M's specially equipped Michael S. Aldrich Sleep Disorders Laboratory, Hoban and others study the sleep patterns of scores of children a year, using monitoring equipment to find evidence of everything from insomnia and sleep walking to breathing problems and narcolepsy. They and others are also discovering that kids and teens have much different sleep patterns than adults.

As children grow from infants to toddlers to preschoolers and kinder-



gartners, parents face a constant evolution of their children's sleep patterns. The newborn who needed 16 hours of sleep and naps interrupted by feedings develops quickly into a youngster who can sleep through the night but needs a nap or two to achieve their nine to 13 hours of needed sleep.

In these little ones, struggles at bedtime and nighttime waking are common as they try to exert their independence but still harbor some of babyhood's traits. Hoban advises parents to establish a pleasant bedtime routine at a regular time that includes such activities as brushing teeth and tucking in, but to set limits and respond consistently to demands, tantrums and stalling. Worries about the dark and monsters can be fought with nightlights and reassurances.

Parents should leave their children's room when bedtime comes, Hoban advises, to avoid having the child become too dependent on having a parent present in order to sleep, and to allow the child to develop his or her own "settling down" abilities.

Fighting daytime sleepiness

As children grow older their push for control over their sleep routines and their need to get up early and stay alert all day in school makes good sleep hygiene habits even harder to establish — but more important to stick to. If they aren't the child's

daytime behavior can be affected.

"It's becoming increasingly recognized that there are tired children in school, and that the tiredness may take different forms," Hoban explains. "It may not just be out-and-out sleepiness and falling asleep, but also being grumpy or irritable, or having problems sustaining attention."

School-age kids obtain less sleep than they did only a few years earlier, often getting by on eight to just over nine hours, which is often less sleep than required for optimal daytime alertness and performance. Their schedules increasingly become their own during the day and evening, so they may try to exert the same control at bedtime.

"This is a time when kids will sometimes push the limits," says Hoban. "We actually see some kids this age having problems of sleep deprivation, meaning that they may not allow themselves enough time for sleep." Parents who try to impose naps may even make the problem worse.

Sleep walking and talking or night terrors that provoke crying and screaming without waking or nightmares also arise more frequently at these ages. So can apnea, in which breathing interruptions during sleep can cause both physical and behavioral problems. Parents should consult their child's physician about these issues.

To confront sleep deprivation and other problems, Hoban advises a mix of common sense and scientific approach. "In general, we don't recommend too many stimulating activities just before bedtime, like video games and vigorous athletic pursuits. These can make it tougher for a young person to gear down and be in a relaxed, quiet state that's conducive to sleep. And we recommend trying to keep bed times relatively regular because it helps govern the body's circadian rhythm — the intrinsic brain activity that governs sleep."

Keeping the child's bed reserved just for sleeping instead of home-

work, reading and TV can also help, especially for kids who have insomnia or those whose circadian rhythms are changing. "If somebody is not feeling sleepy, they should get up, leave the bed, and be allowed to do something quiet until they feel drowsy," Hoban suggests.

Delayed sleep phase

As kids grow into adolescence, sleep deprivation and daytime sleepiness take center stage due to rebellion against parental control, packed school and activity schedules, and natural changes.

"Adolescents will very often have irregular sleep habits, staying up substantially later on weekends than on school nights and making it tough for the body to establish its own circadian rhythms," Hoban explains. "And teens may be balancing schoolwork, jobs and family activities that may have an impact on their evening time and bed time."

Teens are natural "owls," with a body clock that makes them alert and energetic during the evening and inclined to sleep later than younger kids and adults in the morning. Combine this with irregularity of bedtimes, and early school start times, and some adolescents develop something called "delayed sleep phase syndrome." Body rhythms keep such teens from being tired until the wee hours of the morning, and morning schedules prevent them from getting the eight to 10 hours of sleep their bodies would normally demand.

"There is increasing evidence in the medical literature that there is a substantial proportion of adolescents with this tendency," Hoban says. He notes that some school districts have started to change their high school start times to allow students to sleep later in accordance with their natural rhythms. Not enough evidence has come in to say whether or not this improves attendance and alertness, Hoban cautions, but studies are under way.

As much as possible teens should heed the advice given to their

Just the facts

■ The amount of sleep an individual needs each day varies from person to person, but generally is around 16 hours for newborns and around eight hours for adults.

■ Sleep is crucial for maintaining physical well-being, helping to regulate growth and possibly in helping imprint long-term memory.

■ Each night of sleep features a repeating cycle of stages, marked by shifts in brain and body activity. Dream-filled rapid eye movement, or REM, sleep, and four stages of light and deep non-REM sleep all occur in different amounts in children and adults.

■ In 1999, a survey found that 20 percent of kids under age 18 complained of being tired during the day, and 15 percent of kids reported falling asleep at school during the previous year.

■ Half of sleep time during infancy is REM stage, but by adulthood it's only about 25 percent.

younger siblings and try to get to bed around the same time each night after a "wind down" time of quiet activity. Anti-insomnia medication or herbs often help only temporarily and can't make up for bad habits.

Web information

■ UMHS Health Topics A to Z Normal Sleep Patterns in Children www.med.umich.edu/libr/child/child42.htm

■ UMHS Health Topics A to Z Sleep Disorders Clinic www.med.umich.edu/neuro/sleep.htm

■ American Academy of Child & Adolescent Psychiatry Children's Sleep Problems www.aacap.org/publication/factsfam/sleep.htm

■ National Sleep Foundation Sleep Tips for Teens www.sleepfoundation.org/PresArchives/seven.html

MEDICAL DATEBOOK

FIBROMYALGIA
The Fibromyalgia/Chronic Fatigue Support Group meets 7 p.m. the second Thursday of each month at the Livonia Civic Center Library on Five Mile Road, east of Farmington. Call (248) 346-3164.

MON, SEPT. 10
THYROID DISORDER SUPPORT
Meets at 6:30 p.m. in the Plymouth Library, 223 S. Main in Plymouth. The program will start at 7 p.m. and will feature Dr. Gary Weltman from Prime-care in Novi. Call Tracy Green at (734) 453-7945 or e-mail mtsg@mediaone.net.

TUE, SEPT. 11
BREAST CANCER
The Breast Cancer Support Group of St. Mary Mercy Hospital will meet from 7-9 p.m. Sept. 11 and Oct. 9 to help survivors address topics and concerns relating to breast cancer.

MOTHER-BABY POSTPARTUM
The Mother-Baby Postpartum Support Group of St. Mary Mercy Hospital will meet from 10-11 a.m. with a lactation specialist to talk about the postpartum period of adjustment. Infants welcome.

DIABETES EDUCATION SERIES
St. Mary Mercy Hospital is offering a series of classes entitled "Taking Charge of Living With Diabetes." The series is designed to help diabetics over age 18

with self-care and diabetes management. Five classes will be held from 7-9 p.m. on Sept. 11, 13, 18, 20 and 25. The classes are held in Pavilion A. To pre-register, call (734) 655-8940.

SEPT. 11 & 25
ANGELA HOSPICE
Ongoing support groups meet 1 p.m. and 6 p.m. the second and fourth Tuesday of the month at Angela Hospice, 14100 Newburgh Road, Livonia. Open to the public. Call Ruth Favor, bereavement coordinator, at (734) 464-7810.

WED, SEPT. 12
ARTHRITIS
St. Mary Mercy Hospital will present the Arthritis Foundation of Michigan's "Arthritis Self-help Course" during a series of three classes to meet on Wednesdays, Sept. 12, 19, and 26. Classes meet from 1-3 p.m. in the hospital's Pavilion Conference Room A. People with any form of arthritis or related diseases may attend. The seminar costs \$20 per person plus \$5 for a spouse, family member or a friend to attend with the registered participant. Pre-register by calling (734) 655-8940.

THUR, SEPT. 13
FIBROMYALGIA SEMINAR
Dr. Paul Masalkis of Lowen Chiro-

iropractic Clinic will present "Fibromyalgia - A Natural Approach" at 7 p.m. at the Farmington Community Library, 23500 Liberty Street, Farmington (near Police Department). For more information call (248) 474-6767.

ADULT CPR CLASS
On Sept. 13 and Sept. 19, St. Mary Mercy Hospital will offer CPR instruction by certified trainers. Classes meet from 6-9 p.m. in the hospital auditorium. The first class will focus on adult CPR and the second day will focus on CPR for infants and children. One-person rescue technique, and the Heimlich maneuver will be taught. Participants will receive a written exam and card. Pre-registration is required. Call (734) 655-8940 to register.

DIABETES CLASSES
The U-M Health System will offer free classes for African-Americans 18 years and older with diabetes. Learn about proper nutrition, exercise, medication, and prevention of kidney disease, blindness, amputations and other problems. Classes held 5:30-7:30 p.m. at New Hope Outreach Clinic, 229 Chapin Street (near Miller), Ann Arbor. More locations being added. Call 1-

800-529-5345
SAT, SEPT. 15
PROSTATE CANCER FORUM
The American Cancer Society hosts, "Let's Talk About It" at the Focus HOPE conference center in Detroit. Motivational speaker Les Brown will share the story of his personal battle with prostate cancer. Local medical professionals will talk about prostate cancer screening, complications and treatment options. The free forum is open to the public and lunch will be provided. The registration deadline is Aug. 24. Call (248) 557-5353.

SEPT. 17-21
PROSTATE SCREENINGS
Oakwood Healthcare System will offer free prostate screening tests for men who are 50+ years old, have a family history of cancer, or are 35+ and African-American or Hispanic. Screenings will take place at several locations. Appointments necessary. Call 800-543-WELL.

TUE, SEPT. 18
GRIEF RECOVERY WORKSHOP

Hospice of Washtenaw will host a five-week grief recovery workshop beginning Tuesday, Sept. 16 for five consecutive Tuesdays, ending Oct. 18. The workshops will help people who have lost loved ones adapt to the loss and develop new skills in coping. The workshop series is open to the public and there is no charge. It is recommended that participants attend all five sessions. All discussions are confidential. Registration is required. Call (734) 327-3409 for more information.

WED, SEPT. 19
MICHIGAN DYSLLEXIA SUPPORT
Parents, professionals, students and adults with dyslexia are invited to attend a presentation on maximizing audiobooks effectively and getting organized with homework. The group meets from 7 to 9 p.m. at the Michigan Dyslexia Institute, 30230 Orchard Lake Road, Suite 130, Farmington Hills. For more information call (248) 737-0044.

OSTEOPOROSIS DISCUSSION

Senior Health Services of Saint Joseph Mercy Health System of Ann Arbor will present "Senior Health Day" 1:30-2:30 p.m. at Canton Summit on the Park, 46000 Summit Parkway, Canton. Dr. Bharati Srivastava will present "Understanding Osteoporosis and What You Can Do To Reduce Your Risks." To register, call (734) 397-5444.

FIBROMYALGIA
Correct Care Chiropractic will present a free community workshop on fibromyalgia 7:30 p.m. at the Redford Community Center. Learn about non-drug solutions. Call (313) 537-8100.

THUR, SEPT. 20
CHEMICAL SENSITIVITY
Multiple Chemical Sensitivity Friends Support Group will meet 2-5 p.m. at the Good Food Company, 42615 Ford Road (1/2 mile west of I-275 at Kukkt), Canton. Public is welcome. Please come unscented. For more information or a newsletter, call 248-349-4972.

Arthritis Today
JOSEPH J. WEISS, M.D. RHEUMATOLOGY
18829 Farmington Road
Livonia, Michigan 48152
Phone: (248) 478-7860

ALCOHOL AND GOUT
Alcohol does not cause gout. Rather, heavy drinking affects the kidney's ability to rid the body of uric acid, which is the cause of gout. Uric acid results from the breakdown of protein in our body. It's a normal activity that the body regulates depending on intake of protein and the level of uric acid in the blood. The kidney contains special cells which secrete uric acid and excrete it into the urine. Alcohol impedes that process. If the body of uric acid builds up high enough, then gout results. Another way that alcohol can cause gout is by the impurities dissolved in the alcohol. In England in the 18th century, much of the wine consumed was sold in lead-lined casks. Lead-like alcohol interferes with the kidney's ability to excrete uric acid. The same set of circumstances existed in America during prohibition with the making of large amounts of bootleg, quinine-laced containing wine. Both in England in the 18th century and America in the twentieth century, the incidence of gout increased dramatically. You won't run the risk of being on an attack of gout if you don't drink in excess. The only exception are a few unlucky people who for reasons unknown are prone to gout attacks even with uric acid levels that are normal. In that unusual circumstance, even moderate drinking may slow the elimination of uric acid enough to precipitate an attack. You would be misguided to forswear wine in the belief that you would end your risk for gout. In most cases, attacks of gout have nothing to do with drinking. Of course, at times, sober judgment is in order in deciding how much you drink and when.

www.drjweiss.yourmd.com

Are You Suffering From Severe PMS SYMPTOMS?

	5	6	7	8
2 Anxiety				
9 Depression	13	14	15	
10 Severe Mood Swings	16	17	18	19
11 Irritability	23	24	25	26
	27	28	29	

•Females 18-40
•Who experience these symptoms one week before menstruation that interfere with normal functioning
•All qualified volunteers will receive study medication, study related health assessments and compensation for their time

Please contact PRC Research 866.841.9090 for details about this Study

PRC Psychopharmacology Research Corporation (PRC Research)
28300 Orchard Lake Road • Suite 150
Farmington Hills, MI 48334

Laser Hair Removal
A Craig Catell MD and Associates offer the latest advances in treatments and cutting edge laser technology. Let us put 20 years of experience in dermatology to work for you to ensure your complete satisfaction.

- SKIN DISEASES
- SKIN CANCER
- ACNE
- MOHS SURGERY
- PSORIASIS
- SCLEROTHERAPY
- BOTOX
- INJECTIONS
- LASER SURGERY
- COLLAGEN IMPLANT
- SPIDER VEIN TREATMENT
- ACID PEELS
- WRINKLES
- AGING SKIN

734-455-6881
990 W. Ann Arbor Trail • Plymouth
734-996-8757
706 W. Huron • Ann Arbor
www.craigcatell.com

CALENDAR

FOR ADDITIONAL LISTINGS CHECK HOMETOWNNEWSPAPERS.NET

AROUND TOWN

CAR WASH
The Canton High Cheer-leading Squad will be holding a car wash from 10 a.m. to 3 p.m. Saturday, Sept. 15, at the Classy Chassis Auto Wash on Canton Center Road. For further information, call Richard Reaume at 459-9285.

TINY TOTS PROGRAM
The Salvation Army is giving a Tiny Tots program on Sept. 10, at the Plymouth Salvation Army on South Main. The 3-year-old registration is still on. School begins Monday, Sept. 17. For more information call Peggy Blaisdel at (734) 459-1358.

WATER AEROBICS
Classes in water aerobics and hatha yoga being held at Medhealth Systems in Plymouth on Tuesday and Thursdays, beginning Sept. 11, for six weeks. Cost is \$40 per class. Call (734) 459-3831 for dates and times.

INLINE ROLLER HOCKEY
Fall leagues are open for all ages at Skatin' Station II in Canton. The 10-week session is \$120 with one game a week and includes skates for champion teams, a game jersey, ref fees and hockey stats, rosters, schedules, champion pictures will now be posted on the Web. Registration is going on now. Call (734) 459-6401 for more information.

PCAC AUDITIONS
Auditions for the Whistle Stop Players production of *Charlie and the Chocolate Factory* are ongoing. Audition workshop for ages 5 and up. Select one and come for the entire time 6:30-8 p.m. Sept. 9 or 13. Parent must sign child in for auditions. Production in December. Call Jennifer Tobin at (734) 416-4ART.

CUB SCOUT RALLY
Pack 854 is holding Rally Night at Miller Elementary School gym at 7 p.m. Tuesday, Sept. 18. Grades 1-5 are welcomed. Any questions, call Tom Johnson at (734) 453-7732.

HEART WALK
Join your friends and neighbors at the Metro Detroit American Heart Walk on Saturday, Sept. 22, at Oakland University. This is a one-mile or 2.5-mile route on a slightly hilly course and a festival area with fun for the entire family. For more information, call (800) 968-1793.

CANTON KID'S DAY
Oakwood Healthcare Center will celebrate kids at the annual kids day. The event runs noon to 4 p.m. Saturday, Sept. 15, at the center. This year's event features guests from the Detroit Rockers soccer team. Children and their parents can participate in an afternoon of festivities including free refreshments, games and prizes.

ART CLASSES
Plymouth Community Arts Council is offering classes including a Folk Art Series, Pottery, Preschool art, Art Club for fifth-graders and older and Sculpture classes. Also offering "School's Out" classes for those days when kids have a half day of school. Call (734) 416-4278 for further information and schedules.

ANTIQUICLINIC
Canton Historical Society is hosting DuMouchelle Antique Appraisal Clinic from 10 a.m. to 5 p.m. Sept. 29 at the Cherry Hill Methodist Church. Appointments necessary. The cost is \$9 per item/oral appraisal, \$12 per item/written appraisal.

Call (734) 453-5297 to schedule appointment time.

SUICIDE PREVENTION
Youth Suicide Prevention Week will be observed Sept. 16-21. The first event will be held on the steps of the Capitol in Lansing on Sunday, Sept. 16, by families who have lost a loved one to suicide. For more information or to participate, contact Glenda at (313) 561-2456.

LEAGUE MEETING
The League of Women Voters of Northwest Wayne County hosts a membership meeting at 7:15 p.m. Wednesday, Sept. 12, at the Civic Center Library on Five Mile. Laura Callow of ERAmerica will speak on new developments in the fight to pass the ERA, and a film will be shown. Paula Bowman (734) 669-5830 days or (734) 455-4726 evenings.

FLEA MARKET
Royal Holiday Clubhouse on Warren in Canton is holding a flea market 9 a.m. to 4 p.m. Saturday, Sept. 15.

MUSIC AUDITION
Village Music Studio auditioning members for the Rising Star Singers, a youth show choir. Auditions being held 7-8:30 p.m. Tuesday, Sept. 18. Bring prepared song to sing accompaniment provided.

AMERICAN CANCER WALK
On Saturday, Oct. 13, the American Cancer Society will host "Making Strides Against Breast Cancer" a walking event that celebrates breast cancer survivorship and promotes breast health awareness. Being held at Detroit's Belle Isle Park with registration beginning at 8:30 a.m. For more information, call (800) ACS-2345.

GENEALOGY CLASS
Northville Genealogical Society presents Tom Thompson, former president of Western Wayne Genealogical Society, holding a class on how to plan your research and the pitfalls he has uncovered in doing research for 25 years. This class is at 2:30 p.m. Sunday, Sept. 9, at the Northville District Library. For more information, call (734) 420-3622.

CRAFT SHOW
Crafters are needed for the 15th annual juried show from 9 a.m. to 4 p.m. Saturday, Oct. 20, at West Middle School in Plymouth. Call Terri at (248) 349-5344 for more information.

SYMPHONY AUDITIONS
Evola Music Center of Canton will host auditions for the Plymouth Symphony Orchestra from 4-8 p.m. Monday, Sept. 10. The Symphony is seeking experienced players with advanced musical skills for fall auditions for the 56th concert season. Contact personnel manager William Hulsker at (313) 640-1773.

MUSICAL STORIES
Engaging songs, instrument play, playful stories and little feet moving in time to music. September sessions, 4:15 p.m. Wednesday, Sept. 12, at the Great Harvest Bread in Northville, 9:30 a.m. and Tuesday, Sept. 18, at the Plymouth Coffee Bean in Plymouth. Call Evola Music (734) 455-4677 for classes or for a free brochure.

THEATER AUDITIONS
Auditions for *Charlotte's Web* will be held at the Marquis Theatre at 7 p.m. Sunday, Sept. 16. Children 8-16 years old can audition. Performers must prepare a song in their vocal range and bring their own sheet music. Performers must

Hollywood's Golden Era now showing



On screen: Movie-goers gathered at the Showcase Cinemas in Westland last week to watch the 1940s classic, "State Fair," on Silver Screen Wednesday. You can see a classic movie the first Wednesday of each month at 1 p.m. for only \$1 with free popcorn, drinks and other munchies. Next month's feature is "Annie."



STAFF PHOTO BY BRYAN MITCHELL

also prepare to read a poem no longer than two minutes. It does not have to be memorized. For more information call (248) 349-8110.

INFANT CARE CLASS
St. Mary Mercy Hospital will offer a two part infant care class. Sept. 6 and Sept. 13 designed for parents and caregivers of newborns and infants. Participants may attend one or both classes. Call (734) 655-1100 for further information.

COMPOSTER PROGRAM
Learn the how to's of Rouge River water quality protection through composting, yard waste reduction and gardening during Wayne County's Master Composter Program. The program runs 6:30-8 p.m. Thursdays through Oct. 11. The classes will be held at Summit on the Park in Canton. For further information, call (734) 326-3936.

FLEA MARKET
Livonia Historical Society presenting a flea market from 10 a.m. to 4 p.m. Sunday, Sept. 9, at Green mead Historical Park. Admission is \$1 for children under 12. Free food and refreshments available. For more information, call (248) 477-7375.

CRAFT SHOW
The Village Painters present The Treasure Chest Craft Show 2001, 10 a.m. to 5 p.m. Sunday, Sept. 9, at Central Middle School. Admission is \$2.

PLYMOUTH SYMPHONY LEAGUE
The Plymouth Symphony League is selling 2002 Entertainment books to support the orchestra's 2001-2002 concert season. Buyers ordering now will receive a free 2001 Values

Book, while supplies last. The 2002 book price has been reduced to \$30. To order, call (734) 451-2112.

TAI CHI CLASSES
Beginner classes start at 7 p.m. Monday, Sept. 10 in Livonia and Bloomfield Hills. Classes for seniors begin at 1 p.m. Wednesday, Sept. 12 at the Livonia location. For more information call the society at (248) 332-1281.

ICE HOCKEY LEAGUES
Leagues are now forming for kids 4-17 to play at the new Arctic Edge of Canton starting this fall. Applications are available through September in the Summit on the Park lobby or by calling the Canton Hockey Association at (734) 207-1002.

ANNIVERSARY PARTY
Bird Elementary School will celebrate 50 years of learning with a '50s style party and open house noon to 4 p.m. Saturday, Sept. 22, at the school, 220 Sheldon (northwest corner of Sheldon and Ann Arbor Trail). Parents, students, alumni, former administrators, teachers and support staff may attend. For more information, call the Bird School office at (734) 416-3100 or the Bird 50th hotline at (734) 454-0487.

ENTERTAINMENT BOOKS
Plymouth Community Chorus is selling 2002 Entertainment Books to pay for its charitable and educational activities. Buyers ordering now will receive a free 2001 Values Book, while supplies last. Price of book has been reduced to \$30. To order, call Stan at (734) 459-6829.

MAYBURY STATE PARK
Summer Evening Series 7 p.m. each Thursday. Each week a different topic is covered from Maybury's

natural or cultural history with hikes and slide programs. All programs are free however, a state park motor vehicle permit is required for entry to the park.

DUFFERS & DINERS
Sundays at the Golden Fox or Fox Hills through September. Eighteen holes at \$100/couple tee times, noon to 4 p.m. nine holes \$80/couple tee times 2-4 p.m. Price includes your choice of steak or chicken dinner, golf and cart. Please call for tee times (734) 453-7272.

BICYCLE RIDES
Bike tours throughout the Plymouth community, starting at 6 p.m. Mondays through October at the Comerica Bank on Ann Arbor Road, west of Sheldon. Find out how to bike to the area focal points while minimizing sharing the road with fast-moving motorists. For further information, call Alan VanKerckhove (734) 455-9144.

HISTORICAL MUSEUM
Hours for the Canton Historical Museum are 1-4 p.m. Tuesday and Saturday. Tours for school, Scouts or other groups may be arranged by calling (734) 397-0088.

VILLAGE MUSIC
Group classes in piano and hammer dulcimer for people ages 5 to adult. The complete Kindermusik curriculum is offered for newborns to children 7 years old. For information, call Norma Atwood at (734) 354-9825.

HATHA YOGA
Classes in Plymouth 7:30-9 p.m. Tuesdays, Wednesdays, and Thursdays. Call Cynthia Gray, (734) 420-2418, for further information.

RECREATION

The city of Plymouth is taking registration for its children's/tots gymnastics, dance, arts, Jump-A-Rama, tai kwan do, personal development, aerobics and more. For more information, call the recreation division at (734) 455-6620.

SKATING CLASSES
Learn to roller-skate at Skatin' Station II in Canton for children or adults, 7-8 p.m. every Sunday. The cost is \$6 per session or \$30 for six weeks. Little roller hockey leagues for all ages. Ten week session with one game a week for all ages. Call (734) 459-6401 for information.

CREATIVE MUSIC
The Creative Music Center of Plymouth/Canton has registration for its Kindermusik classes. Ages infant to seven years old. Classes are held at the First Baptist Church of Plymouth, 45000 N. Territorial (just west of Sheldon), beginning Sept. 4. For information, call Amy Brewer at (734) 513-5855 or (734) 207-8654.

CLUBS

FARM AND GARDEN
Plymouth Woman's National Farm and Garden Association will open its fall season at 12:30 p.m. Monday, Sept. 10, at the home of Joan Connor. Club members will pick the category for the Aisle of Wreaths at Cobo Hall, benefiting Children's Hospital. Call 340-2062 for further information.

MARSP
The Michigan Association of Retired School Personnel will host a luncheon at 11:30 a.m. Wednesday, Sept. 12 at the K of C Hall on Farmington Road in Livonia. Call (734) 421-1296 for reservations. The Silver Strings Dulcimer Society will present a program of folk music. New members welcome.

D.A.R.
The Plymouth-Northville chapter of D.A.R. will host a sandwich luncheon at noon Sept. 17 at the Northville Library. The program is "Museum Quilts" with speaker Laura Merwin. Call Shri Hering (734) 455-5525 for further information.

MOMS IN TOUCH
A fall rally from 9 a.m. to noon Friday, Sept. 28, at Huron Hills Baptist Church in Ann Arbor. Come be encouraged, and challenged by the difference you can make in the lives of children, teacher, administrators and other school staff. RSVP by Sept. 14 to Karen Jeffries at (734) 397-2771.

NACW
The September meeting of West Suburban Chapter of National Association of Career Women is at 11:45 a.m. Tuesday, Sept. 11, at Ernesto's in Plymouth. Cost is \$18 for members and \$22 for non-members. RSVP Brenda Durling (734) 462-4670.

MOMS CLUB
Western Wayne County stay-at-home mothers may meet at 10 a.m. the third Tuesday of each month. The group offer play groups, activities, outings and community service opportunities. Call Tamme at (734) 525-8955 for further information.

SINGLETONS
Single people ages 45 and older wishing further information regarding activities may write Dearborn-Livonia Singletons, P.O. Box 2175, Fort Dearborn Station, Dearborn, MI 48123. The next dinner social is at 5:30 p.m. Friday, Sept. 14, at Pick-A-

Bone on Six Mile in Livonia.

STAMP CLUB
Meeting at 8 p.m. the first and third Fridays of the month at the Plymouth Historical Society, 155 S. Main St., Plymouth.

PLYMOUTH CANTON JAYCEES
Looking for people 21-39 interested in making friends, helping with good causes and having a good time. The Jaycees meet at 7:30 p.m. every second Wednesday of the month at the Plymouth Township Clerk's Office. Call (734) 453-8407 or show up at the group's monthly meeting.

COMMUNITY DEMOCRATS
The Community Democratic Club meets at 7 p.m. on the third Wednesday of every month at UAW Local 845 Hall. Business meeting begins at 7:30 p.m. The club serves Canton, Northville, Plymouth and the Livonia 13th District. For further information, call Becky Tavarozzi (734) 398-5845.

TOASTMASTERS
Develop your public speaking, communications and leadership skills. Guests welcome. No pressure to speak. Being held at St. John Episcopal Church in Plymouth. This group meets at 7 p.m. every first and third Monday of the month. Please call (734) 459-0715 for more information.

WESTSIDE SINGLES
Westside Singles presents dances every Friday night at the Burton Manor. Doors open at 8 p.m., dressy attire. Bar D.J., 21 and older. Price is \$4 before 8:30 p.m. and \$6 after 8:30 p.m. Call (734) 981-0909 for further information.

K OF C BREAKFAST
The Knights of Columbus holds a breakfast buffet 8:30 a.m. to noon every Sunday at the Knights of Columbus Hall, 150 Fair St., Plymouth. All-you-can-eat buffet. Newly remodeled breakfast room. Call (734) 453-9833 for further information.

ARTS COUNCIL
Every second Tuesday at noon you may take your lunch and learn about art with the speakers from the DIA. The cost is \$5 for members and \$8 for others. Lectures are free to senior citizens. Winter 2001 classes for children-acting, singing, drawing, sketching and painting. For adults photography, drawing, sketching, watercolor, salsa dance, and figure drawing with models. Art or drama birthday parties or Scout workshops custom designed for each group (any age) at the Plymouth Community Arts Council. For information, call (734) 416-4278.

KIWANIS BREAKFAST CLUB
The Plymouth-Canton Kiwanis Breakfast Club meets 7 a.m. every Tuesday at the Plymouth Cultural Center, 525 Farmer, Plymouth. Guests are welcome. Call Charr Briggs at (810) 406-8489.

BNI
The Canton II Chapter of Business Network International (BNI) meets 7-8:30 a.m. every Wednesday at Roman Forum Restaurant, 41601 Ford, Canton. The Laurel Park Chapter meets 7-8:30 a.m. at Arche's Family Restaurant on Plymouth Road, east of Merriman, Livonia. The Plymouth Chapter meets every Thursday at the Plymouth Cultural Center, 525 Farmer, Plymouth. The Livonia Chapter meets 7-8:30 a.m. at Senate Coney Island on Plymouth at Stark, Livonia. Call the BNI regional office at (810) 323-3800.

CALENDAR FORM

The Plymouth and Canton Observers welcome Calendar items. Items should be from non-profit community groups or individuals announcing a community program or event. Please type or print the information below and mail your item to The Calendar, Plymouth and Canton Observers, 794 South Main Street, Plymouth, MI 48170, or by fax to 734-459-4224. Deadline for Calendar items is noon Thursday for the following Sunday's paper. Call 459-2700 if you have any questions.

Event: _____

Date and Time: _____

Location: _____

Telephone: _____

Additional Info.: _____

Use additional sheet if necessary

WJR 760am QUALITY OF LIFE SYMPOSIUM

SUNDAY, SEPTEMBER 16th

PRESENTED BY



WRIGHT FILIPPIS

TROY MARRIOTT, 200 W. Big Beaver (east of I-75)

SESSION ONE. PREPARING FOR THE FUTURE 9AM-NOON

- 8:30** REGISTRATION Refreshments
- 9:00** **INTRODUCTION** Marie Osborne, WJR News Anchor/Reporter
- 9:10** **ADVANCES IN MEDICAL TREATMENT EXTENDING LIFE & QUALITY OF LIFE**
Joel Steinberg, M.D., Assistant Prof Of Internal Medicine, WSU, Program Director for Geriatric Medical Fellowship Program
- STOPPING THE CLOCK THROUGH EXERCISE**
Bruce Deschere, M.D., MSBA, Pres Univ Physicians Services, Inc., Professor of Family Medicine, WSU
- 10:00** **HELP AVAILABLE THROUGH MEDICARE/MEDICAID ASSISTANCE PROGRAM**
Sarah Slocum, Director, M M A P
- 10:30** **FINANCIAL IMPLICATIONS OF LONGER LIFE SPANS**
Stephen Moses, Pres, Center for Long Term Care Financing
- 11:00** **PLANNING FOR THE FUTURE**
Stacey Cassis, First VP State Sales Mgr, Standard Financial Services
- 11:30** **ESTATE PLANNING**
P Mark Accettura, Estate Planning Attorney, Author "Lost and Found Finding Self-reliance After the Loss of a Spouse"
- 12:00** Q & A / Breakaway

SESSION TWO: RESOURCES AVAILABLE 1PM-4PM

- 12:30** REGISTRATION Refreshments
- 1:00** **INTRODUCTION** Marie Osborne, WJR News Anchor/Reporter, & Dell Warner, Seniors Reporter, WDIV-TV 4
"Body and Mind", Writer, Detroit Free Press
- 1:10** **BARRIER FREE LIVING IN HOME EQUIPMENT**
Dori Zavis, Dir. of Sales & Mkg., Caring Solutions
- 2:00** **MANAGING CAREGIVER CONFUSION**
Sanford Linden, Pres., Professional Parent Care
- 3:00** **PHYSICIANS HOUSE CALLS PAID BY MEDICARE**
Eric Baron, M.D., Founder & Medical Dir., House Call Physicians, PC
- 3:00** **LONG TERM CARE INITIATIVE**
Brenda Fink, Acting Dir. Long Term Care Initiative, Mich. Dept. of Community Health
- 3:30** **ASSISTED LIVING / LONG TERM CARE**
Judith G Caroselli, RN, CNHA, Dir of Operations, Westland Convalescent
- COMMUNITY SERVICES FOR CANCER PATIENTS AND THEIR FAMILIES**
Nancy McHugh, Reg. Dir. Community Outreach, Barbara Ann Karmanos Cancer Institute
- HOSPICE CARE**
Dorothy Deremo, Pres & CEO / Hospice of Michigan
- 4:00-5:00** Q & A / Breakaway



BON SECOURS NURSING CARE CENTER & ASSISTED LIVING COMMUNITY



Life is our life's work. www.pfizer.com

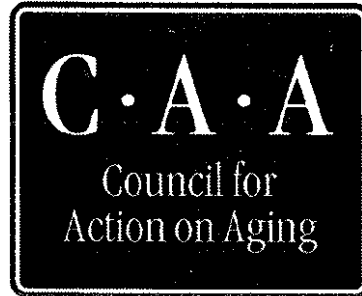

C.A.A.

Council for Action on Aging



CENTER FOR LONG-TERM CARE FINANCING



Blue Cross Blue Shield Blue Care Network of Michigan

Nonprofit corporation and independent licensee of the Blue Cross and Blue Shield Association

WAYNE STATE UNIVERSITY PHYSICIAN GROUP



Standard Financial Services A Division of AEN AMRO Financial Services, Inc



More for Our Community, Easy for You!

Introducing Two Great Ways We're Helping Our Schools and Communities!

We're proud to bring you two new and easy programs to benefit your favorite community organizations and local schools. Participation is FREE. Just sign up for your Serving You More key tag at any of our stores! We'll give back a portion of **all** your purchases* to benefit the community groups and schools you've selected.

**There are no receipts to collect,
no vouchers to purchase - we do the work!**

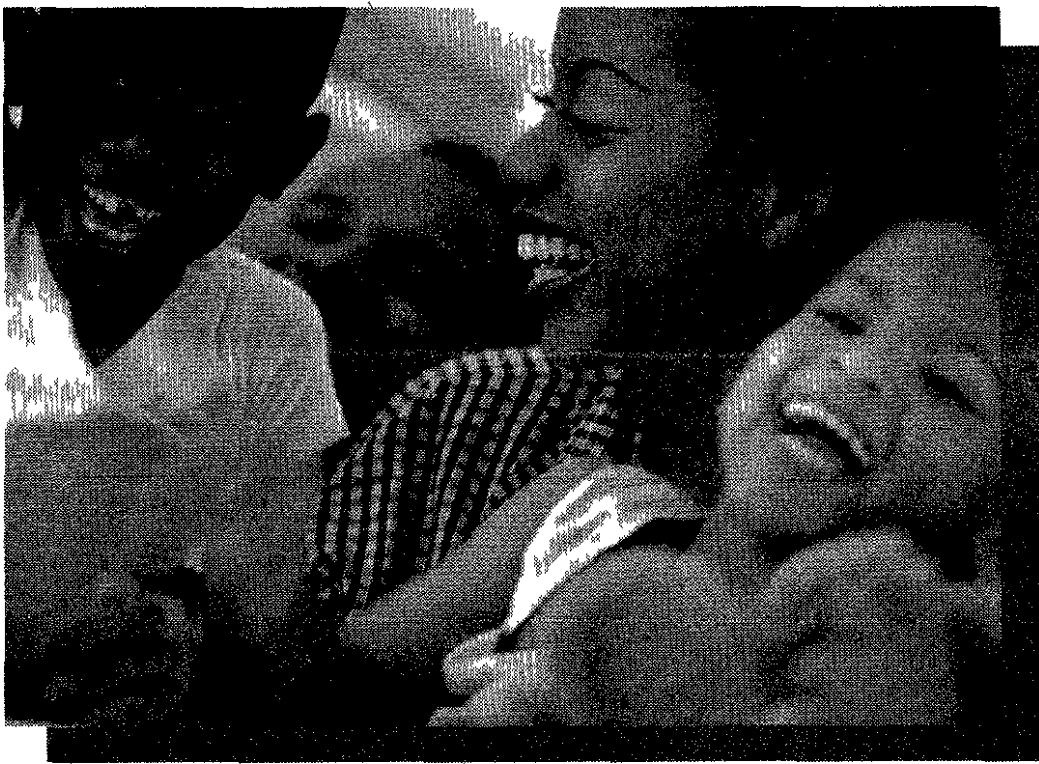

Help Your Favorite School Earn Equipment

Each time you have your Serving You More key tag scanned at our checkout from September 9, 2001- March 23, 2002, the public or private school of your choice will be awarded credit based on the amount of your purchases*.

- All schools, both public and private, kindergarten through 12th grade, are eligible to participate.
- Contributions are automatic. You or your schools do not need to collect receipts, keep track of purchases, etc. We do that for you!
- Your school can then use this credit to purchase educational equipment and supplies.
- Schools earn credit based on **all** your purchases* in our stores.

*Excludes purchases of alcohol, tobacco, prescription drugs, postage stamps, money orders, lottery tickets, gift certificates, city trash bags and tags.

See our stores for details.



Holiday Market

520 S. Lilley • Canton • (734) 844-2200



The Serving You
More Program

3934UN9/01

PDF 00006

Observer & Eccentric

REAL ESTATE

observer-eccentric.com

Your classified ad is automatically posted on the internet! Visit us today

303 Open Houses
Novi
Open Sun 1-4
Don't miss your chance at this stunning 5,621 sq ft home...

303 Open Houses
S Lyon
OPEN SUN 1 4
25522 Sawgrass Ct Tangle wood Sub S of 10 Mile W of Beek 2 story end unit Granite & maple 3 bedrooms 2 1/2 baths...

305 Birmingham/Bloomfield
BEVERLY HILLS updated 3 bedroom all brick fireplace landscaped lot great kitchen \$297,000...
BIRMINGHAM Great location great condition! Many updates 2 full baths 1 w/Whirlpool Call for details \$189,900...

308 Canton
CONTEMPORARY COUNTRY!
Updated 3 bedroom 2 bath ranch over 2 acres Tennis court in law guest quarters double deck w/ hot tub & pool much more! Call Debbie Loe at 888 600 2923...

314 Farmington/Farmington Hills
BIG FAMILY HOME IN FARMINGTON
5 bedroom home 2 car garage full basement All new mechanics major updates Walking distance from Elmeria Taylor School award winning Farmington School District Large family room deck and beautifully landscaped...

319 Hamburg
CAPE COD in quiet sub 2 bedrooms 2 Baths 1700sqft New in 95 oak throughout Loft overlooks great room with vaulted ceilings, Fieldstone fire place Sprinklers deck & much more! \$227,000 734-844-3974

325 Livonia
BEAUTIFULLY MAINTAINED 4 Bedroom Colonial in great Livonia sub Updates throughout including kitchen roof furnace & hot water heater Family room w/gorgeous stone fireplace Basement 2 Car attached garage \$294,900 Call Carol White Century 21 Hartford South Inc 313 618 0225

325 Livonia
OPEN SUNDAY 1 4
38545 Tuscany Ct S of 5 Mile E of Hagerty Sharp Livonia Colonial with many updates! \$249,850
GAIL TURNER (248)973 0057
Real Estate One...
43155 Main St Ste 2300 Novi

334 Plymouth
PLYMOUTH JUST LISTED!
Great starter home! 3 bedroom brick ranch with attached garage & full basement on large lot Bring your decorating ideas and make this home a beauty! Hard wood floors under carpet All appliances stay! Immediate occupancy Offered at only \$179,900!

OPEN SUNDAY 1-4
LIVONIA Immediate occupancy on this beautifully updated Burton Hollow Colonial Many recent updates including family room addition featuring vaulted ceiling with skylights and canyon stone fireplace New cedar deck vinyl siding & windows furnace water heater and central air 35037 Ellen St of 6 Mile off Wayne Go E on Bristol to Edgewood to Ellen Ct Call Lou Ronayne at (248)735 5477 KELLER WILLIAMS REALTY

OPEN SUNDAY 1 4
29242 Guy St Spacious 4 bed room 2 1/2 bath Colonial master bedroom bath 2 1/2 car attached garage formal dining breakfast library attached garage 1st floor laundry \$239,900 248 354 6708
SOUTHFIELD Open Sat Sun 12 5 25946 Acaola 5 bedroom 2 1/2 bath colonial family room with fireplace formal dining breakfast library attached garage 1st floor laundry \$239,900 248 354 6708

BIRMINGHAM Open Sun 1 4
New construction Victorian style for the 1st century! Offering mixed textures & old world craftsmanship with a zen feeling Architect designed & built 2680 sq ft \$669,000 867 Davis (248) 342 8656
FRANKLIN Bingham Farms Design/build from \$675,000 \$2,000,000 Wooded lots w/walk out to Howard Stanley Custom Homes 248 137 4000 248 683 9950 248 300 5850

OPEN HOUSE SUNDAY 9 9 01
14pm N of Geddes & W of Lantana Corner 3 bedroom 2 1/2 bath Cape Cod Part finished basement 2 Car garage \$259,900 Call Tim Courtney (ATCRIP)

FREE! SEARCH over 500 homes for sale in Farmington/Farmington Hills online at www.LvngInFarmingtonHills.com
\$3,000 MOVES you in! 3 Bed room 2 bath brick ranch Flr finished basement 2 car garage Florida room reduced to \$165,900 PHAVIA O Down Towns Call Larry VanZandt (734) 459-8222 Re/MAX Great Lakes

OPEN SUN SEPT 9 14PM
OPEN FOR ADMIRATION!
Be the first to see this beautiful 4 bedroom 3 1/2 bath 2 story home in desirable San Marino Park Subdivision! Limestone floors greet you as you enter the foyer of this lovely 2 263 sq ft home Home features a lovely kitchen and eating area with tiled counter tops and limestone floors formal dining room living room family room with gas fireplace 1st floor laundry partially finished walkout lower level and 3 car attached garage! Huge deck and in-ground pool perfect for entertaining on a large scale and beautifully landscaped yard that overlooks 8 acre common park area for an added bonus! Hartland Schools \$338,000 Take Me 59 West of US-23 to South on Westview Trail then follow open signs to 1792 Parkridge Court

OPEN SUN SEPT 9 14PM
NEARLY AN ACRE
with trees & ponds Westside 3 bedrooms 1500+ sq ft 2 car garage New white kitchen & base \$249,900 248 553 0219 www.hno.com ID# 12919

ROSEDALE GARDENS
Lovely 3 bedroom 2 bath colonial on a lot and a half! Covered ceilings and hardwood floors 2 car garage Wonderful living space with living dining and family rooms plus part of the basement finished \$324,900
BY OWNER 36228 Northfield Betsy E Newburgh 3 bedroom brick ranch, basement 1028 sq ft numerous updates \$159,900 (734) 261 9880

SEeing is Believing!
Looking for that special place to call home? Look no more This lovely colonial is turn key 4 bedrooms 3 baths 2 lavs Formal living dining library Fabulous kitchen w/dual gas fireplace oak cabinets expanded island pantry & hardwood flooring Stone cook top microwave included 4 car garage Spacious! Wonderful lot almost an acre Price at \$559,500
Diane Howard
Real Estate One... (313)201-5757
a mail therelopro@aol.com

OPEN SUNDAY 1 5
15046 Robinwood
Four bedroom 2 bath home updated kitchen baths & windows 2 car attached garage must see \$234,900 734-420 3430

WEST BLOOMFIELD
ALL SPORTS LAKE
Open 1 4
Custom renovated in 1999 Approx 3500 Extensive use of granite marble and stone 2 story entrance 4 bed rooms 3 baths large master bedroom walk in closet 2 person jacuzzi Must Sell! No reasonable offer refused \$799,900
Call FRANCES GANTZ (248) 642 8100 CENTURY 21 Town & Country

OPEN HOUSE SUNDAY 9 9 01
14pm N of Geddes & W of Lantana Corner 3 bedroom 2 1/2 bath Cape Cod Part finished basement 2 Car garage \$259,900 Call Tim Courtney (ATCRIP)

OPEN SUN 1 4
30150 West gage N/13 Mile E/Ochard Ln Large colonial on nearly 1 acre lot includes 4 bedrooms 2 1/2 baths and 3 fireplaces Basement sub in room hardwood floors and much more \$379,900 (21059411)

OPEN SUN 1 4
30150 West gage N/13 Mile E/Ochard Ln Large colonial on nearly 1 acre lot includes 4 bedrooms 2 1/2 baths and 3 fireplaces Basement sub in room hardwood floors and much more \$379,900 (21059411)

OPEN SUN 1 4
30150 West gage N/13 Mile E/Ochard Ln Large colonial on nearly 1 acre lot includes 4 bedrooms 2 1/2 baths and 3 fireplaces Basement sub in room hardwood floors and much more \$379,900 (21059411)

OPEN SUN 1 4
30150 West gage N/13 Mile E/Ochard Ln Large colonial on nearly 1 acre lot includes 4 bedrooms 2 1/2 baths and 3 fireplaces Basement sub in room hardwood floors and much more \$379,900 (21059411)

OPEN SUN 1 4
30150 West gage N/13 Mile E/Ochard Ln Large colonial on nearly 1 acre lot includes 4 bedrooms 2 1/2 baths and 3 fireplaces Basement sub in room hardwood floors and much more \$379,900 (21059411)

REDFORD
OPEN HOUSE
14 Sunday
15936 Kinloch
S on 5 Mile past Inkster left on Kinloch
Updated kitchen and bath 3 bedrooms open floor plan family room with half bath all appliances included immediate occupancy

PLYMOUTH CONDO
Open sun 12 5 768 York 2 bedroom 2 1/2 bath Gas fireplace 2 1/2 car garage Large private decks master bedroom overlooks woods All appliances included garage \$162,900 734-451 8890 Stufeldt@earthlink.net

PLYMOUTH
GORGEOUS HOME
Definitely done right! Four bedroom lot with updated home Maple kitchen hardwood floors new windows roof siding furnace A/C Finished basement 2 car garage S/S M/W/Hagerty Follow signs Open 1 4 ANITA BOWERS (734)416 1229 COLDWELL BANKER® Coldwell Banker Preferred (734)416-1212

NEWER BUILT
3 Bedroom brick ranch 1800 sq ft w/finished walkout another 1600 sq ft 6 baths attached garage loaded w/appliances 2 car access to all sports lake \$234,900 Call Larry VanZandt 248 473 6205 Re/MAX Great Lakes

OPEN SUN 1 5pm 1800
sq ft ranch 4 bedroom w/finished walk out basement 1 acre \$262,000 4071 Basin By owner (610) 227 3254

OPEN SUN 1 4
30150 West gage N/13 Mile E/Ochard Ln Large colonial on nearly 1 acre lot includes 4 bedrooms 2 1/2 baths and 3 fireplaces Basement sub in room hardwood floors and much more \$379,900 (21059411)

OPEN SUN 1 4
30150 West gage N/13 Mile E/Ochard Ln Large colonial on nearly 1 acre lot includes 4 bedrooms 2 1/2 baths and 3 fireplaces Basement sub in room hardwood floors and much more \$379,900 (21059411)

OPEN SUN 1 4
30150 West gage N/13 Mile E/Ochard Ln Large colonial on nearly 1 acre lot includes 4 bedrooms 2 1/2 baths and 3 fireplaces Basement sub in room hardwood floors and much more \$379,900 (21059411)

OPEN SUN 1 4
30150 West gage N/13 Mile E/Ochard Ln Large colonial on nearly 1 acre lot includes 4 bedrooms 2 1/2 baths and 3 fireplaces Basement sub in room hardwood floors and much more \$379,900 (21059411)

REDFORD
OPEN HOUSE
14 Sunday
15936 Kinloch
S on 5 Mile past Inkster left on Kinloch
Updated kitchen and bath 3 bedrooms open floor plan family room with half bath all appliances included immediate occupancy

REDFORD
OPEN HOUSE
14 Sunday
15936 Kinloch
S on 5 Mile past Inkster left on Kinloch
Updated kitchen and bath 3 bedrooms open floor plan family room with half bath all appliances included immediate occupancy

WESTLAND
Livonia Schools
3 bedroom brick ranch base ment quiet sub Updated kitchen & 1 1/2 bath w/walk out landscaping 2 1/2 car garage Asking \$180,000 Open Sun 1 4pm 8600 Cardwell 734 422 1027

CLARKSTON
Nestled on ten secluded acres of wooded lake front Living room 2 bedrooms 2 1/2 baths office den family room w/fireplace 2 car garage \$379,000 (248) 620-9988

DEARBORN
DEARBORN HEIGHTS
BY OWNER 3 bedrooms 2 baths leaded glass windows hardwood floors Open Sun 1 4pm 23124 Beech Dearborn 313 565 2493

CLARKSTON
Nestled on ten secluded acres of wooded lake front Living room 2 bedrooms 2 1/2 baths office den family room w/fireplace 2 car garage \$379,000 (248) 620-9988

CLARKSTON
Nestled on ten secluded acres of wooded lake front Living room 2 bedrooms 2 1/2 baths office den family room w/fireplace 2 car garage \$379,000 (248) 620-9988

CLARKSTON
Nestled on ten secluded acres of wooded lake front Living room 2 bedrooms 2 1/2 baths office den family room w/fireplace 2 car garage \$379,000 (248) 620-9988

CLARKSTON
Nestled on ten secluded acres of wooded lake front Living room 2 bedrooms 2 1/2 baths office den family room w/fireplace 2 car garage \$379,000 (248) 620-9988

CLARKSTON
Nestled on ten secluded acres of wooded lake front Living room 2 bedrooms 2 1/2 baths office den family room w/fireplace 2 car garage \$379,000 (248) 620-9988

REDFORD
OPEN SUN 1 5
STOP PAYING RENT!
This great newly decorated 3 bed room 1 full 2 half bath brick ranch with 2 fireplaces has too many extras to list Some updates include new windows doors and floors Corner recently located close to I 96 it won't last at this price \$164,900 14114 Garfield N of Schoolcraft E of Beech Daily or by appointment (313) 533-8579

WESTLAND
Livonia Schools
3 bedroom brick ranch base ment quiet sub Updated kitchen & 1 1/2 bath w/walk out landscaping 2 1/2 car garage Asking \$180,000 Open Sun 1 4pm 8600 Cardwell 734 422 1027

CLARKSTON
Nestled on ten secluded acres of wooded lake front Living room 2 bedrooms 2 1/2 baths office den family room w/fireplace 2 car garage \$379,000 (248) 620-9988

CLARKSTON
Nestled on ten secluded acres of wooded lake front Living room 2 bedrooms 2 1/2 baths office den family room w/fireplace 2 car garage \$379,000 (248) 620-9988

CLARKSTON
Nestled on ten secluded acres of wooded lake front Living room 2 bedrooms 2 1/2 baths office den family room w/fireplace 2 car garage \$379,000 (248) 620-9988

CLARKSTON
Nestled on ten secluded acres of wooded lake front Living room 2 bedrooms 2 1/2 baths office den family room w/fireplace 2 car garage \$379,000 (248) 620-9988

CLARKSTON
Nestled on ten secluded acres of wooded lake front Living room 2 bedrooms 2 1/2 baths office den family room w/fireplace 2 car garage \$379,000 (248) 620-9988

CLARKSTON
Nestled on ten secluded acres of wooded lake front Living room 2 bedrooms 2 1/2 baths office den family room w/fireplace 2 car garage \$379,000 (248) 620-9988

CLARKSTON
Nestled on ten secluded acres of wooded lake front Living room 2 bedrooms 2 1/2 baths office den family room w/fireplace 2 car garage \$379,000 (248) 620-9988

ROYAL OAK
OPEN SUN 12 4
16724 Beech Daily Clean updated kitchen & bath 3 bed room glass block windows in basement 1 1/2 baths garage formal dining room & much more \$128,500 ERA Country Ridge Realty (248) 474-3303

ROYAL OAK
OPEN SUN 12 4
16724 Beech Daily Clean updated kitchen & bath 3 bed room glass block windows in basement 1 1/2 baths garage formal dining room & much more \$128,500 ERA Country Ridge Realty (248) 474-3303

ROYAL OAK
OPEN SUN 12 4
16724 Beech Daily Clean updated kitchen & bath 3 bed room glass block windows in basement 1 1/2 baths garage formal dining room & much more \$128,500 ERA Country Ridge Realty (248) 474-3303

ROYAL OAK
OPEN SUN 12 4
16724 Beech Daily Clean updated kitchen & bath 3 bed room glass block windows in basement 1 1/2 baths garage formal dining room & much more \$128,500 ERA Country Ridge Realty (248) 474-3303

ROYAL OAK
OPEN SUN 12 4
16724 Beech Daily Clean updated kitchen & bath 3 bed room glass block windows in basement 1 1/2 baths garage formal dining room & much more \$128,500 ERA Country Ridge Realty (248) 474-3303

ROYAL OAK
OPEN SUN 12 4
16724 Beech Daily Clean updated kitchen & bath 3 bed room glass block windows in basement 1 1/2 baths garage formal dining room & much more \$128,500 ERA Country Ridge Realty (248) 474-3303

ROYAL OAK
OPEN SUN 12 4
16724 Beech Daily Clean updated kitchen & bath 3 bed room glass block windows in basement 1 1/2 baths garage formal dining room & much more \$128,500 ERA Country Ridge Realty (248) 474-3303

ROYAL OAK
OPEN SUN 12 4
16724 Beech Daily Clean updated kitchen & bath 3 bed room glass block windows in basement 1 1/2 baths garage formal dining room & much more \$128,500 ERA Country Ridge Realty (248) 474-3303

ROYAL OAK
OPEN SUN 12 4
16724 Beech Daily Clean updated kitchen & bath 3 bed room glass block windows in basement 1 1/2 baths garage formal dining room & much more \$128,500 ERA Country Ridge Realty (248) 474-3303

337 Royal Oak/Oak Park-
Huntington Woods

JUST LISTED
CHARM & CHARACTER
best explain this warm and com-
fortable home located within
walking distance of downtown
Royal Oak. Many updates in-
cluding all mechanicals, 3
bedrooms 1 bath + must see!
\$184,900 ECH 18UNI
(248)968-1400

338 Salem/Salem
Township

GORGEOUS
Custom built Contemporary 4
bedrooms 2.5 baths on private
3.5 acres w/wooded back yard
3 car garage 2nd story private
curved staircase fireplace in
living room & family room central
air motivated seller says bring
offers Asking \$550,000 (BRNSAL)
Call **ROBERT CUFFE**

REMERICA
INTEGRITY REALTORS
734-525-4200

339 Southfield-Lathrup

OPEN SUN 1-4
2155 S. Tuller Court
N of 11 E off Lahser
Contemporary 3 bedroom 1 1/2
bath ranch w/wood deck overlooking
spacious yard C/A fireplace 2
car attached garage \$145,000
Call Carolyn Winokowsky
248-991-2003
Prudential Chamberlain Stehli

SOUTHFIELD BY OWNER
Colonial S of 12 E of Lahser
2841 sq ft 5 bedrooms with 2
master suites 3 full baths
upstairs +2 half baths down lots
of large closets Large living
family & dining rooms Updated
kitchen 2 car side entry garage
w/wood fireplace in living room
w/wood cabinets finished basement
New heater c/a & windows
Large deck beautifully landscaped
scaped automatic sprinkler
system & large storage shed
\$299,500 (248) 352-9892

SOUTHFIELD
Reduced Completely re-
vated Farm House w/3
1/2 baths & 1st floor
laundry New windows
roof & oak cabinets Deck
covered front porch & 2 car
garage \$103,000 (BY273)
CENTURY 21 TODAY
(734)462-9800

340 South Lyon

**IMMEDIATE
OCCUPANCY**
Stunning Eaton
Colonial
Model Home at
The Estates of
Trotters Pointe
Now Available

- 4 bedrooms 2 1/2 baths
- First floor study
- w/wooded French doors
- Huge kitchen w/ island
desk breakfast nook
w/French door to backyard
- Family room w/cathedral
ceiling bay window
& fireplace
- Spacious master suite
w/ walk in closet &
maste bath w/ corner
jetted tub
- 3 Lyon Schools adjacent
to High School
- Exceptionally priced at
\$324,975

For more information &
directions please call
248-466-4979

Open until 11:6

Toll Brothers
Real Estate

**NEVER BUILT 3 BEDROOM
RANCH**
2 Car attached garage 2 full
baths full basement many
updates 0 Down FHA/VA
Terms \$178,900
Call Larry VanZandt
248 473 6205
Re/Max Great Lakes

OPEN SUN 1 4 900 Stony
S/11 Mile & W/Martindale Sharp
colonial in family sub 3 bed
room \$216,500 248-486-5332

WARM COMFORTABLE
4 bedroom 2 1/2 bath historical
gem built during Martin Van
Buren's presidency 1837 2 por-
geous acres Restored to
museum quality yet truly func-
tional \$339,000

Delaney
(248) 349-6200
www.jadelaney.com

341 Troy

BIRMINGHAM SCHOOLS 3
bedroom 2 full bath frame home
on 3/4 acre secluded lot great
for developer (248)646-8127

COLONIAL 4 bedroom 2 1/2
baths Nice park setting
\$289,000 248-528-2012

1141 NICKLAUS golf course
community in the heart of
Golf Trail Sub Fabulous 3 bed
room 2 1/2 bath all brick ranch
featuring library that could be
4th bedroom grandiose finished
basement w/wet bar neutral
interior with new Berber car-
peting 2 way fireplace & much
more Golf Trail Sub offers a
private park including soccer field
volleyball tennis and basketball
courts Only \$280,000 Appoint-
ments only 248-766-8020

TROY'S FINEST 3 bedroom
2 1/2 bath c/a alarm in ground
sprinklers professional land
scape partial finished base-
ment \$329,000 (248) 879-0833

342 Waterford/Union
Lake/White Lake

ALLSPORTS LAKE 3600 sq ft
deck & much more Only
\$147,300 Rates are low buy
now Call GERT (734) 459-3600
Realty Executives West

WESTLAND GREAT BUY
Lots of extras Second full bath
New kitchen and baths 2 Car
garage full finished basement
only \$122,700 Seller may help
w/closing

CALL GERT
(734) 459-3600
Realty Executives West

WESTLAND
MINT CONDITION
OPEN SUN 1 4
33418 FERNWOOD
Newer 2 Story Open floor plan
front dining area oak kitchen
w/ island finished basement
deck & much more Only
\$147,300 Rates are low buy
now Call GERT (734) 459-3600
Realty Executives West

342 Waterford/Union
Lake/White Lake

**LAKE FRONT LIVING AT ITS
BEST!** You must get inside to
appreciate this beautiful
home on Lake Onal Living room
with vaulted ceiling fireplace
and full wall of windows to enjoy
the lake views! Dining room has
downhill to one of the many
decks 3 bedrooms 2 baths full
finished walkout lower level
includes 4th bedroom and large
family room 2 car attached
garage and Huron Valley
Schools \$289,000

ENGLAND REAL ESTATE
(248) 474-4530

342 Waterford/Union
Lake/White Lake

WHITE LAKE NEW HOME
10380 North Ridge Ct (M 59 S
on Teggederine E on Elizabeth
Lk Rd S on Oxtow Lk Rd)
Over 2600 sq ft custom built 2
story 4 bedroom 2 1/2 bath
basement \$334,900 Open
Sun Noon-4 or call for appt
Todd Glenn Holmes
248 620 2122

344 W. Bloomfield-
Orchard Lk/Keego

W BLOOMFIELD OPEN SUN
1000 4pm Listing
Reduced \$25,000 to \$375,000
3179 sq ft top of the line inside
& out 5 yrs old all the extras
w/ Bloomfield Schools Bring all
offers \$250,000 2 wks 5340
Cherry Blossom Circle (Hiller &
Greer) (248) 682-4669

**WEST BLOOMFIELD
BEAUTY**
Unique 4 bedroom Colonial with
Hammond Lake access
Updated flooring windows C/A
roof sump pump kitchen &
bath Entertainer's dream!
\$300,000

DENISE MCGUIGAN
REMERICA HOMETOWN III
(313) 796-1436

345 Westland/Wayne

BEAUTIFUL
3 bedroom brick ranch with 1 1/2
car garage fireplace in living
room suzuzi in bathroom deck
& pond in backyard & more!
\$145,900 (67PAR)

REMERICA
734-525-4200

SPACIOUS & BEAUTIFUL
Built in 1900 this Victorian style
home offers 1900 sq ft +/- 3
bedrooms 2 1/2 baths living
room family room dining room
partially finished basement nat-
ural wood throughout New roof
2000 Outside painted in 2000
Newer furnace and A/C unit last
4 years 10x10 1st floor laundry
sweeper refrigerator dishwasher
freezer stay New 220V line in
house One of Wayne's finest A
real must see home \$124,900
(356EL)

**COLDWELL
BANKER**
Coldwell Banker Preferred
(734) 459-6000

JUST REDUCED!
Country Ranch in The City Spa-
cious 3 bedroom ranch with
family size kitchen large master
bedroom with private bath 2 full
baths total Open & airy layout
Huge cedar kitchen island
garage on big wooded lot JUST
waiting to move in Asking
\$189,900 (734) 722-8634

OPEN SUNDAY 1-4 32074
Fairchild S of Chery Hill W of
Merriman Sharp 3 bedroom
ranch with remodeled kitchen &
bath central air finished base-
ment 2 car garage newer win-
dows \$136,000 Call Don Boone
(356EL)

CASTELLI 734 525 7900

OPEN SUNDAY 2 4 8411
Gilmran N of Ann Arbor Trail
W of Inkster Fantastic 4 bed
room home with a family room
fireplace 2 full baths central air
basement 2 car garage over
1600 sq ft \$168,900

LARGER 3 bedroom brk
Ranch w/in a spacious kitchen
central air w/wood windows
shk occupancy \$74,900

SHARP 3 bedroom brk
Colonial with a family room
fireplace updated kitchen 2 1/2
bath central air basement and
first floor laundry attached 2
car garage many extras newly
listed at \$259,900

CASTELLI 734 525 7900

TWO FIREPLACES
Just listed beautiful brick ranch
with aluminum trim in near per-
fect condition Offers a large
family room with fireplace plus
fireplace in living room 3 bed
rooms 2 car garage with
attached workshop windows
nice updates A must see at
\$129,900 (Harrison)

4 BEDROOM RANCH
Large kitchen updated last year
newer ceramic bath updated
shingles finished basement
deck and 2 car garage Priced to
sell at \$127,900 Call us today!
(Staubert)

Call Jim Mike &
Chuck Anderson
Century 21 Dynamic
(734) 728-7800

UPGRADES THROUGHOUT
this beautiful 2 bedroom Ranch
Large lot for all your outdoor
activities 2 Car garage Home
Warranty \$114,900

734 464-6400
Century 21 Hartford South
www.c21.hs.com

3250 sq ft custom walk out
separate 900 sq ft RV garage
\$1 375 000 517 548-3509

LAKELAND
1500 sq ft 3 bedroom 2 bath
home 3 car garage on Huron
River chain on Strawberry Lake
Large lot underground sprin-
klers landscaped totally remod-
eled 1991 2 large decks
\$375,000 (810) 231-9005

PORT AUSTIN (Broken Rocks)
Enjoy spectacular sunsets &
sunsetts from this lovely year
round home in the prestigious
gated community of Broken
Rocks 75 Lake Huron beach
frontage 3 bedrooms 2 baths
sauna living room kitchen
cathedral ceiling family room
fireplace Large multi level deck
\$300,000 248 644 4823

342 Waterford/Union
Lake/White Lake

WOODED LAKEFRONT!
Wooded lakefront, 1 000 acre
lake bordered by National
Forest \$47,000 8 Daily
Lake Realty TOLL FREE
888 805 5320
www.louklake.com

W BLOOMFIELD Prime lot
on serene Green Lake Spacious
home with many upgrades
\$1.5 million (248) 360 6499

348 Wixom/Walled Lake/
Commerce

WEST BLOOMFIELD
All SPORTS LAKE
Open 1 4
Custom renovated in 1999
Approx 3 000 Extensive use
of granite marble and stone
2 story entrance 4 bed
rooms 3 baths Large
master suite walk in closet 2
person jacuzzi Must Sell
No reasonable offer refused
\$799 900

Call FRANCES GANTZ
(248) 642 8100
CENTURY 21
Town & Country

**WE always find the best stuff
in our Classifieds!**

348 Wixom/Walled Lake/
Commerce

COLONIAL hardwood floors
fireplace open plan neutral
decor 3 car deck sprinklers
2 300 sq ft Walled Lake
Schools \$315 000
(248) 980 4223

COMMERCE TWP 1995 2
story 3 bedroom 2 1/2 bath full
basement 25 car attached
wooded private cul-de-sac many
extras \$259 000 248-980-3720

348 Wixom/Walled Lk/
Commerce

WALLED LAKE 2 bedroom
many updates new roof new
siding 1 car garage \$132 500
(248) 489 9077

WIXOM Beautiful custom built
4 bedroom 2 1/2 bath First floor
laundry C/A on premium lot w/
over sized 2 car garage Profes-
sionally finished basement
\$279 000 Call 248 624-4052

349 Ypsilanti/Belleville

BELLEVILLE 4 bdrm 2 1/2
baths 2475 sq ft backs to
woods 2 story great room built
2000 \$255 000 (734) 325 2440

Van Buren
BETTER THAN NEW!
1998 Built 4 bedrooms 3 full
baths tons of upgrades finished
basement w/in law quarters and
2nd kitchen massive new deck
hot tub marble fireplace 2 5 car
garage & much more \$239 900
Diane Braykovich at RE/MAX
300 Inc (248) 348 3000 ext
234

352 Livingston County

BRIGHTON AREA New Con-
struction 1800 sq ft Colonial
\$179 900 \$210 000 Hardwood
floors fireplace 3 bedroom 2 1/2
bath 1st floor laundry 1/2 acre
lot paved roads & sewers
Close to town immediate
Occupancy 810 225 8944

WINNING COMBINATION
convenience comfort and
country peace & quiet with this
spacious TN level nestled on
2 7/8 private acres Home offers
scenic views paved drive large
open living area w/wooded
private kitchen dining area
leads to large deck 23x24 party
sized Great Room family room
for relaxing and 2nd kitchen for
possible in law quarters 2 car
attached garage Fenton
Schools \$224 623

ENGLAND REAL ESTATE
(248) 474-4530

352 Livingston County

AUBURN HILLS
**WESTBURY
VILLAGE**
Luxury Townhomes
From \$1160/mo
2 & 3 Bedrooms 2 1/2 baths
1500 sq ft private entrance
plus welcome all appliances
includes microwave washer
& dryer
Short term and corporate
housing available

MOVE IN TODAY!!
Call for our
fabulous special!!
(248) 852-7550
On Squirrel Rd
Just S of M 59

352 Livingston County

BIRMINGHAM 2 bedroom
downsize Hardwood floors
Freshly updated Move in MINT
\$150 000 248 581 5444

BIRMINGHAM CONDO
Rare 2 bedroom end unit with
garage & amenity Classic
Townhouse style lots of recent
updates Walk to park New
kitchen hardwood floors thru
out Secured parking garage
basement & 1 car garage
\$121 900

FRANK BURKETT
KELLER WILLIAMS REALTY
810 360 5041

354 Oakland County

ADDISON TWP 3 bedroom
brick ranch 3 acres newly
remodeled Call for information
& appt (810) 795 4614

CLAWSON CUTIE Great
family home 4 Bedroom 1 1/2
bath family room basement &
garage Updated kitchen &
bath New carpet windows &
tile Clean well maintained
Immediate occupancy Home
warranty included Call Tess
Mickelsen Century 21 Hartford
South Inc 313 657 5700

**INKSTER DELIGHTFUL 3 bed-
room 2 bath bungalow**
w/Westland/Wayne schools
updates throughout Finished
basement 2 Car garage close
to park Home Warranty \$115,000

734 464 6400
Century 21 Hartford South
www.c21.hs.com

OAKLAND TWP By owner
Home on 4 acres \$299 000
Call (248) 608 8036
www.in.co.mi/413789

357 Wayne County

ROMULUS OPEN HOUSE
Sunday 9 00 11 4pm 3 bed
room 1 1/2 bath Tri level Base
ment garage with heated
workshop \$119 900 Call Mar
Lagrow (AMLMPE)

REMERICA
HOMETOWN
(734) 459 6222

**TAYLOR IMMEDIATE OCCU-
PANCY** for this well maintained 3
bedroom Ranch Lots of updates
throughout partially finished
basement w/krotry pit & wet
bar 2 Car garage \$117 900

358 Lakefront/
Waterfront Homes

BENNETT LAKE 80 ft of
lakefront on all sports private
lake with access to Lobdell
and Housington 1 000 acres
in all 3 bedroom 2 bath
home w/lots of updates
Owner transferred and ready
owned \$285 000 Call Diane
Dell
(810) 735 1762
(734) 927 1417

CANTON CONDO
The Light of Pleasant Run
Beautiful 3 bedroom Cap Cod
immediate occupancy Golf
pool library great location
\$255 000

DENISE MCGUIGAN
REMERICA HOMETOWN III
(313) 796 1436

CANTON Lower end unit 2
bedrooms 2 baths All apps
anose Ask for Jean 734-297-5106
or 734-844-3517

358 Lakefront/
Waterfront Homes

LAKEFRONT LUXURY CONDO
2 bedroom 2 full bath jazz
skylights cathedral ceilings
attached garage full basement
security system all kitchen appli-
ances \$240 000 248-613-9337

Canton
OPEN SUNDAY 1 4
43584 Yorkville
N/Palmer E/Sheldon Living is
easy in this 2 bedroom 1 1/2 bath
condo is light & bright a great
finished room in basement
Attached garage \$187 000
JUDY POWELL
734-651 1643

Real Estate Inc.
38705 7 Mile Livonia

FARMINGTON HILLS Senior
complex 2 bedrooms 2 baths
all appliances enclosed porch
private entrance ground floor
\$129 900 734 286-9334

358 Lakefront/
Waterfront Homes

**WHITEHORSE
LAKEFRONT**
Outstanding 1997 built 4600
sq ft brick ranch w/views of
lake from most every room!
Offering the finest amenities
thru out home has great
room w/fieldstone fireplace
formal dining room library &
fabulous kitchen w/granite
countertops appliances &
2 way fireplace to dining
room Three bedrooms
master ste w/fireplace &
glamour bath Finished walk
out lower level has family
room w/fireplace game room
and patio decks 3+ car
garage \$748 900 (HO525)

Century 21
CENTURY 21 TODAY
(734)482 9800

358 Lakefront/
Waterfront Homes

FARMINGTON HILLS
New townhome built in 2000
Contemporary 1 1/2 story hard-
wood floors in dining/kitchen 2
bedroom 1 1/2 bath gas fireplace
deck appliances included many
upgrades must see! Open
Sunday 1 4 Asking \$195 000
Motivated seller 734-972-4183

N W LIVONIA
1 2 & 3 bedroom units Priced
from \$84 000 to \$124 900 0
Down financing available
Call Larry VanZandt
248 473-6205
Re/Max Great Lakes

LIVONIA 2 bedroom upper
level condo carpet pool new
carpet in unit laundry
w/appliances available now!
\$105 000 (734) 416-5219

NORTHVILLE HIGHLAND
Lakes condo 3 bedroom 1 1/2
bath c/a fireplace \$149 900
By appt (248) 349 9381

NOVI By Owner Olde Orchard
Condo 3 bedroom 1 1/2 baths
1200 sq ft basement Imme-
diate occupancy Needs cosmetic
TLC \$135 000 248 428 6646

NOVI Open Sun 1 4 31036
Silverdale S/14 E/Novi Won-
derful 4 bedroom 2 1/2 bath
detached condo w/2386 square
feet Built in 1995 View of wet
lands & trees to 3rd level Base-
ment 2 Car attached garage
\$299 900 Call Joe Consiglio
Century 21 Hartford South Inc
313 680 3525

NOVI 2 200 Sq ft 2 Bedrooms
2 baths Chiefs kitchen w/granite
countertops and breakfast nook.
Formal living and dining room
Separate den plus a year-round
sun room new w/interior paint
Spectacular wooded and water
views From \$305 000 Contact
Bob Bowden w/The Farmtown
Group @ 248-348-8866

REDFORD TWP 1 bedroom
upper Quiet community
\$54 900 313 937 0109

SOUTHFIELD A terrific buy on
this custom condo at the Arbor
Over 1800 sq ft 3 bed 2 bath
master bedroom suite w/full bath
& walk in closet 2nd Bedroom
(office or den) 2nd full bath
marble foyer & extra large living
room Secured parking garage
under building For recorded info
24 hrs call 1-888-526-9395 ext
2303 Clark & Fron

SOUTHFIELD 2 bedroom 2
bath 30236 Southfield Rd Bat
12 & 13 Mile \$79 000/best Call
(248)661 2232 (248)884-3036

SOUTH LYON Mint condition
3 1/2 bedroom ranch style fea-
tures neutral decor 2 full baths
huge master Florida room w/
door/walk to patio finished
basement & 1 car garage
\$121 900

FRANK BURKETT
KELLER WILLIAMS REALTY
810 360 5041

WALLED LAKE 2 bedroom 1
1/2 bath condo Beautiful fin-
ished basement \$139 500
Call (248) 324 2876

W BLOOMFIELD Greenpointe
condo Updated master ranch
3 1/2 bedroom 3 full baths must
see \$310 000 (248) 861 7490

WESTLAND 1997 desirable
end unit 2 bedroom 2 1/2 bath
finished walk out basement
central air 1 car garage fea-
ture wooded view \$152 900
Call for Appt (734) 326 2322

WESTLAND Detached condo
in Tri Oaks built in 1991 pre-
mium lot 1200 sq ft 2 bed-
rooms 2 baths utility room on
1st floor huge basement dues
\$145 Asking \$196 000 Call
Joanne at (734) 459 0863

WESTLAND Near Canton
\$126,400 513-934-9348 Details
http://home.att.net/~jeanneemr

Westland
OPEN SUN 1 4
7365 Kingston Ct End unit
Townhouse style condo Livonia
Schools 2 bedroom 2 1/2 bath
fireplace in living room walk in
closets newer paint & carpet heat
major appliances Home War-
ranty provided \$143 900
ERA Country Ridge Realty
(248) 474-3303

358 Lakefront/
Waterfront Homes

**WHITEHORSE
LAKEFRONT**
Outstanding 1997 built 4600
sq ft brick ranch w/views of
lake from most every room!
Offering the finest amenities
thru out home has great
room w/fieldstone fireplace
formal dining room library &
fabulous kitchen w/granite
countertops appliances &
2 way fireplace to dining
room Three bedrooms
master ste w/fireplace &
glamour bath Finished walk
out lower level has family
room w/fireplace game room
and patio decks 3+ car
garage \$748 900 (HO525)

Century 21
CENTURY 21 TODAY
(734)482 9800

371 Apartments
For Sale

20 UNITS Wolverine Lake Super
area Great income Many
updates never any vacancies
\$1 475 000 248 386 8494

372 Condos

ADAMS WOODS CONDO
End unit ideal location in sub
Large wooded beautiful Bloom-
field Hills schools Open House
Sat & Sun 1 5pm \$255 900
Won't last (248) 852 2979
1151 Hillpointe Circle

372 Condos

AUBURN HILLS
**WESTBURY
VILLAGE**
Luxury Townhomes
From \$1160/mo
2 & 3 Bedrooms 2 1/2 baths
1500 sq ft private entrance
plus welcome all appliances
includes microwave washer
& dryer
Short term and corporate
housing available

MOVE IN TODAY!!
Call for our
fabulous special!!
(248) 852-7550
On Squirrel Rd
Just S of M 59

372 Condos

BIRMINGHAM 2 bedroom
downsize Hardwood floors
Freshly updated Move in MINT
\$150 000 248 581 5444

BIRMINGHAM CONDO
Rare 2 bedroom end unit with
garage & amenity Classic
Townhouse style lots of recent
updates Walk to park New
kitchen hardwood floors thru
out Secured parking garage
basement & 1 car garage
\$121 900

FRANK BURKETT
KELLER WILLIAMS REALTY
810 360 5041

WALLED LAKE 2 bedroom 1
1/2 bath condo Beautiful fin-
ished basement \$139 500
Call (248) 324 2876

W BLOOMFIELD Greenpointe
condo Updated master ranch
3 1/2 bedroom 3 full baths must
see \$310 000 (248) 861 7490

WESTLAND 1997 desirable
end unit 2 bedroom 2 1/2 bath
finished walk out basement
central air 1 car garage fea-
ture wooded view \$152 900
Call for Appt (734) 326 2322

WESTLAND Detached condo
in Tri Oaks built in 1991 pre-
mium lot 1200 sq ft 2 bed-
rooms 2 baths utility room on
1st floor huge basement dues
\$145 Asking \$196 000 Call
Joanne at (734) 459 0863

WESTLAND Near Canton
\$126,400 513-934-9348 Details
http://home.att.net/~jeanneemr

Westland
OPEN SUN 1 4
7365 Kingston Ct End unit
Townhouse style condo Livonia
Schools 2 bedroom 2 1/2 bath
fireplace in living room walk in
closets newer paint & carpet heat
major appliances Home War-
ranty provided \$143 900
ERA Country Ridge Realty
(248) 474-3303

372 Condos

BLOOMFIELD THE HEATHERS!
NE listing
Private entry 2nd floor unit
Deluxe master suite P vate
2nd Deluxe suite to Perfect
neutral move in condition 1
car garage \$254 000
Real Estate One 248-644-4700
Kathleen Robinson
(248)561 1210

BLOOMFIELD HILLS Telegraph
& Square Lake 2 bedroom 2
bath lake access carpet pool
Completely remodeled Beautiful
location \$130 000
248-431 7375

BLOOMFIELD HILLS Presti-
gous 1 bedroom condo 1 7/8
Square Lake \$81 900 Option to
rent \$800/mo 810 986 4508

372 Condos

**BRIGHTON BUILDER
CLOSEOUT**
Last detached condominium
in the prestigious Oak Pointe
Community with 36 holes of
golf all sports lake and
Country Club 2000 sq ft 1 1/2
story with 1st floor master
suite granite countertops
etc priced to sell at
\$299 900 Immediate Occu-
pancy! Phone 248 446 3911
or 248 350-9090

CANTON CONDO
The Light of Pleasant Run
Beautiful 3 bedroom Cap Cod
immediate occupancy Golf
pool library great location
\$255 000

DENISE MCGUIGAN
REMERICA HOMETOWN III
(313) 796 1436

CANTON Lower end unit 2
bedrooms 2 baths All apps
anose Ask for Jean 734-297-5106
or 734-844-3517

374 Manufactured
Homes

DON'T RENT!
INVEST
IN YOUR OWN HOME
FARMINGTON HILLS
\$465/mo
includes house
payment & lot rent
248-474-6500
10% down \$287/mo
for 360 mths @ 11% APR

Little Valley
Open 7 days

NORTHVILLE CROSSINGS
New Palm Harbor Home 1 600
sq ft set up never lived in 3
bedroom Great Opportunity
\$99/mo lot rent 1 year save
\$1 000 e (800) 742 0704
\$1 000 e

AMERICAN HOMECHOICE

NORTHVILLE 1997 Friendship
3 bedroom 2 bath \$4 500 cash
back! \$47 900 (248)466 4091

374 Manufactured
Homes

\$589 PER MO
INCLUDES LOT RENT!!!
NEW DOUBLE WIDE
5 bedroom
3 bath homes in 3
different communities
Immediate occupancy
Call Today 248-380-9550

374 Manufactured
Homes

\$399 PER MO
INCLUDES LOT RENT!!!
NEW
3 bedroom homes
in 3 different
communities
Immediate occupancy
Call Today 248-380 9550

AMAZING 2 bedroom 1 bath
w/wooded porch All appli-
ances only \$4500 Mobile Home
Brokers 734 697 2433

DOUBLE WIDE only \$19 900 3
bedrooms 2 baths C/A fireplace
on the porch Vacant Mobile
Home Brokers 734 697 2433

NEW HOMES & SITES
Immediate Occupancy
Westland Meadows Westland
734-729 5500

PATRIOT 1995 14 x 60
2 bedroom 1 bath appliances
\$17 900 (248) 474 2131
Flamingo MHC lot #H27

SOLID CLEAN HOME

APARTMENTS

Your classified ad is automatically posted on the internet!
Visit us today

observer-eccentric.com

400's Real Estate For Rent

400 Apartments/Unfurnished	420 Halls/Buildings
401 Apartments/Furn shed	421 Res dence To Exchange
402 Condo's/Townhouses	430 Garage/M/ n Storage
403 Duplexes	440 Wanted To Rent
404 Flats	441 Wanted To Rent
405 Homes	450 Resort Property
406 Lakefront/Waterfront	451 Furniture Rental
407 Homes Rental	456 Rental Agency
408 Mobil Home Rentals	457 Property Management
409 Mobil Home Sites	458 Lease/Option To Buy
410 Southern Rentals	459 House Sitting Service
411 Time Share Rentals	460 Convalescent/Home
412 Vacation Resorts/Rentals	461 Health Care
413 Living Quarters To Share	461 Foster Care
414 Rooms	464 Misc To Rent

Real Estate for Rent

#400-498

400 Apartments/Unfurnished

ARGENTINE/FENTON (7) 2 Bedroom apt s on Silver Lake Rd overlooking pond & scenic woodlands. Newly renovated & redecorated new appliances fixtures flooring kitchen & baths. Leasing starting from \$675/mo includes heat.

SILVER LEAF APARTMENTS 8434 Silver Lake Road (810) 735-1170

BIRMINGHAM Apt to Sublet to March 2 bedrooms air \$720/mo includes water (248) 822-9112

BIRMINGHAM 1 & 2 bedroom carpeted air carport \$650/mo + 13th mo free Call Ann after 6pm 248-647-8469

BIRMINGHAM Maple Road and Columbia near 248-642-8685

400 Apartments/Unfurnished

Canton Brand New 1, 2 & 3 Bedroom Apartment Homes! Now Pre Leasing for Fall

- Canton/Plymouth Schools
- 24 hr fitness center
- Washer/Dryer option
- Private entrance
- Berber style carpet

Canton Club (734) 398-8000

Over the RIVER and next to the GOLF COURSE! FAIRWAY CLUB APARTMENTS FREE Heat, Water & Golf Remodeled Kitchens Great Views (734) 728-1105 EHO

Canton TOWNHOUSES Spacious 2 Bedroom \$640 * \$200 Rebate for new residents only call for details CANTON GARDEN APARTMENTS (734) 455-7440

FARMINGTON HILLS MAPLE RIDGE APTS 23078 Middlebelt Rd 12 bedroom central air \$565/\$665 248-473-5180

400 Apartments/Unfurnished

Country Corner Apts Spacious 1 2 & 3 bedroom apartments & townhomes From \$795 Heat included Formal dining room carport balcony health club pool close to Birmingham Let us fax you our brochure 248-647-6100 1-800-369-6666 30300 Southfield Rd Between 12 & 13 Mi

Farmington Hills BEAT THE HEAT AND TAKE ADVANTAGE OF DIAMOND FOREST COOL SUMMER SPECIALS

DIAMOND FOREST A Cut Above The Rest Exceptionally spacious one and two bedroom apartment homes

- Individual entrance
- In home washer/dryer
- Window blinds
- Fully equipped kitchen with dishwasher & microwave
- patio/balcony
- coated ceilings
- covered parking
- running track pool jacuzzi tennis courts

NO PET RESTRICTIONS 23140 Halsted Road Between Nine Mile & Grand River 1 mile east of I 275 Hours Mon-Fri 10-7 Sat 10-5 Sun 12-5 (248) 471-4848 Email diamondforest@bleznak.com www.diamondforestapartments.com

Farmington Hills HAPPINESS IS Moving into a cozy 1 bedroom apartment Verticals & Carport included Starting at \$570 Cedarbrook Apts 248-478-0322

GARDEN CITY 2 bedroom Includes heat water stove refrigerator \$600 + deposit 313-645-0348 313-561-8871

GARDEN CITY Ford/Memman 2 bedrooms (1 up) free heat water laundry No pets \$750/mo *security Lease 313-274-4822

KEEGO/SYLVAN LAKEFRONT Two Lakes Two bedrooms Too Nice to Miss Heat/water included Carport W/Blomfield Schools Rent \$850/mo Buy \$129,900 (248) 682-7896

400 Apartments/Unfurnished

BEST LOCATIONS, VALUES, LIFESTYLE

PLYMOUTH HILLCREST CLUB APARTMENTS

Near Plymouth/Haggerty Roads Spacious 1 & 2 bedrooms From \$600 Incl Heat • Near Hines Park • Spa k ng Pool • Renovated Apartments Available

888-221-2698 M-F 9-5:30 (closed Sat) 10-3 SUN 12-3

WESTLAND HUNTINGTON ON THE HILL

On-Arbor Trls west of road 1 & 2 Bedroom apartments From \$580 Incl Heat • Near Hines Park • Central air • Ce ng Fans • Dishwashers • Swimming Pool

888-221-2504 M-F 9:30 AM - 10:30 PM, SUN 12-3

NOVI WATERVIEW FARMS APARTMENTS

Entire View Rentals: 7th between West & Bask 1 and 2 Bedrooms From \$540 • By Walley Lake • Patios/Balconies • Pool

888-221-2425 M-F 9:30 AM - 10:30 PM, SUN 12-3

CANTON/PLYMOUTH FRANKLIN PALMER APARTMENTS

On Palmer between Lley & Sheldon Spacious 1 & 2 bedrooms STARTING AT \$575 FREE HEAT 734-397-0200 M-F 9-5 SAT 10-2 SUN 12-3

MORE LOCATIONS! 248-569-8880

GARDEN CITY FORD/MIDDLEBELT AREA

Spacious 1 bedroom Apts Amenities Include • Owner Paid Heat & Water • Central Air • Intercom System • Garbage Disposal • Laundry Facilities • Window Treatments/Min Blinds

FROM \$490 MONTHLY GARDEN CITY TERRACE (734) 522-0480

400 Apartments/Unfurnished

LIVONIA 1 bedroom 1 1/2 bath private entry in quiet neighborhood next to Livonia Main Library \$800/mo 734-427-9082

Livonia FRANKLIN SQ APTS FROM \$590 (HEAT INCLUDED) 1 & 2 Bedroom Apts AFFORDABLE LIVING Great location much more! 5 MILE & MIDDLEBELT 734-427-6970

Livonia HIDDEN TREASURE Heat & water included 1 bedroom \$720 2 bedroom \$820 Immediately available *1 mo free on 12 mo lease* Call Apartment Search 734-981-7200

Livonia LOOK SAVE \$400 OFF YOUR MOVE-IN! • 2 Bedroom/2 Bath • Large 1 Bedroom • Extra Storage • Pet Friendly • Lighted Carpets Incl • Glittering Pool • 24/hr Fitness Center • Quiet Secluded Area

WOODRIDGE APARTMENTS

(Middlebelt Road Between 6 & 7 Mile) (248) 477-6448 E mail woodridge@bleznak.com www.woodridgeapartments.com

LIVONIA'S FINEST LOCATION

Meridian Rd corner of 7 Mile Near Livonia Mall Deluxe 1 & 2 Bedrooms 2 Baths Starting at \$695 Includes Patio or balcony carpeting vertical blinds deluxe appliances pool

MERRIMAN WOODS APTS

248-477-9377 810-775-8206

MOVE-IN \$400 OFF* ALL MONTH 2 Bedroom Apartments

PLUS • Free Heat* • Free Carport • 24 hr workout facility • Sauna • Livon a Schoo s • Beautiful Landscaped Grounds

CALL TODAY! (734) 459-6600 * on select units

NORTHVILLE 1 bedroom apt \$620/mo \$200 off 1st mo rent 1/yr lease 248-348-9250

PLYMOUTH 1 & 2 Bedroom large size quiet buildings heat included starting at \$605 00 per month with 1 yr lease 734-459-9507

400 Apartments/Unfurnished

Madison Heights GREAT APARTMENTS GREAT LOCATIONS Rent includes Heat and Vertical Blinds 6 month or 1 year lease Well maintained Newly decorated

Features • Air conditioning • Refrigerator and range • Smoke detectors • Laundry facilities • Extra storage • Swimming pool • Cable available

1 & 2 Bedroom Apts. LEXINGTON VILLAGE Small Pet Section From \$540 1 75 and 14 Mile opposite Oakland Mall 248-585-4010

PRESIDENT MADISON APTS. From \$585 1 block east of John R just south of Oakland Mall 248-585-0580

HARLO APTS. From \$555 Warren MI West side of Mound Rd just north of 13 Mile Opposite GM Tech Center 810-939-2340

North Royal Oak 1 & 2 Bedroom Apts Features available include microwave dishwasher and individual entrance Rent from \$610 includes heat & water Located on 13 Mile Rd west of Woodward near Beau mont Hospital Oakwood Villa Apartments 248-549-0214

NORTHVILLE/NOVI AREA Short term lease available 2 bedrooms 2 bath Private area near woods (517)688-5107 GM Tech Center

Northville Novi Road North of 8 Mile TREE TOP APARTMENTS • Stunning 1 bedroom w/den • Carport included • Washer/Dryer included • Wooded Streamside Setting • From \$825 Heat included

For an appointment please call 248-347-1990 EHO

NOVI Extremely large 1 & 2 bedroom apartments feature spacious rooms and closets oversized patios/balconies deluxe kitchens vertical blinds central air covered parking for select units. The area's best value from only \$680 EHO

TREE TOP MEADOWS 10 Mile & Meadowbrook (248) 348-9590

It's all about results!

Classifieds Work!

"It's All About Results" 800-579-SELL (7355)

Celebrate the BEAUTY, SPACE and VALUE at

BROOKDALE APARTMENTS

22250 Swan Road
Nine Mile Road just west of Pontiac Trail

Choose an apartment home with:

- ★ Spacious Floor Plans
- ★ Private Balconies
- ★ Brand New Fitness Center
- ★ A Pet-Friendly Environment

Save Up To \$1100 With Our Move-In Special

(248) 437-1223
Fax (248) 437-1100
e-mail brookdale@bleznak.com
www.brookdaleapartments.com

WESTHAVEN MANOR Retirement Community

► Lovely Apartments
► Scheduled Transportation
► Meals served every day (optional)
► Activities Coordinator
► Pets Welcome

All Residents 55 and Older
34601 Elmwood, Westland
734/729-3690
TDD 1-800/649-3777
Equal Housing Opportunity

ENJOY LIFE at Franklin River

Huge One/Two Bedrooms
Walk in Closets
Extra Wide Windows
Vertical Blinds
Free Carport

Specials
Stop In Or Call Today!
248-356-0400
On 12 Mile East of Telegraph

FARMINGTON HILLS 6 MONTH SUMMER SPECIAL \$580/mo 1 large bedroom unfurnished WALNUT CREEK APTS 248-473-1395

FARMINGTON Chatham Hills APARTMENTS

1 and 2 Bedroom Apartments Available

- Olympic Size Indoor Heated Pool
- Attached Garages
- Fully Renovated Apartments Available
- Microwave
- Central Air

CALL NOW (866) 207-5328 toll free

NOVI RIDGE APARTMENTS AND TOWNHOMES

3 great specials to choose from!

6-9 MONTH LEASE No Premium \$500 OFF Move-In Costs Security Deposit \$500	12 MONTH LEASE 1 Month FREE Security Deposit \$99	18 MONTH LEASE 3 Bedroom townhomes \$900-\$1500 OFF Security Deposit \$99
---	---	--

- Attached 1 or 2 car garages
- Modern equipped kitchens
- Washer & dryer hookups in townhomes
- Laundry facilities in every building
- Community clubhouse with fitness center & sauna
- Refreshing swimming pool
- Tennis courts
- Beautiful wooded grounds
- Pets welcome
- Conveniently located near major commercial, educational and recreational sites

23640 CHIPMUNK TRAIL • NOVI, MI 48375 • 248-349-8200 • FAX 248-349-8891
On 10 Mile between Meadowbrook & Novi Rd. • E-MAIL noviridge@bleznak.com • www.noviridgetownhomes.com

WAYNEWOOD Apartments

There is no place like home... at WAYNEWOOD Apartments

734-326-8270

Apartment Homes from \$600!

- Free heat & water
- Patio or balcony
- Dishwasher
- Plus much more!

Open 7 Days!

Located on Wayne Road 1/2 mile south of Warren Road

Concord Towers

MADISON HEIGHTS/TROY/ROYAL OAK

Experience the Quiet, Convenience and Affordability of Concord Towers Apartments

We're minutes from Oakland Mall movie theaters several restaurants and I-75 and I-696 Our spacious and affordable apartment homes have plenty of room for everyone to be very comfortable Our distinctive one and two bedroom floorplans offer ceramic tile baths large living areas and all concrete construction for quiet living

Come Home to Concord Towers for Location, Quality and Affordability. 6 Month Leases Available

One bedroom from \$555
Two bedrooms from \$615

Features: • Storage in each apartment • Fully equipped kitchen with dishwasher & disposal • Fully carpeted • Cable TV available • Laundry on each floor • Central air • 24 hour emergency maintenance • Lighted carpets • Intercom entry system • Elevators

DIRECTIONS: We are located at 14 Mile and I 75 next to the Abbey Theater and directly across from Oakland Mall

Concord Towers Apartments

OFFICE HOURS: Mon-Fri 10-5 • Sat 10-1
(248) 589-3355

32600 Concord Dr. • Madison Heights

Luxury Apartment Living

<h3>Auburn Hills</h3> <p>ADAMS CREEK apartments 1 & 2 bedroom apartment homes Washer and Dryer Close to shopping/dining and entertainment</p> <p>From *735* a month (248) 853-5599 On Adams Rd between South Blvd and Auburn Rd</p>	<h3>Novi</h3> <p>SHOREBROOKE Spacious 2 & 3 bedroom townhomes Attached garage in select homes Excellent Novi schools</p> <p>From *1195* a month (248) 471-7470 Located on Haggerty Rd South of 10 Mile Rd</p>
<h3>Canton</h3> <p>SUMMIT CREEK Luxury 1 2 & 3 bedroom apartment homes Attached 1 or 2 car garage Plymouth/Canton schools</p> <p>From *1095* a month (734) 398-5300 Located on Canton Center Rd North of Mich Ave</p>	<h3>Novi</h3> <p>Wexford 2 & 3 bedroom townhomes Finished walkout in select homes Close to Twelve Oaks Mall and Novi Town Center</p> <p>From *1295* a month (248) 669-1050 At the corner of Novi Rd and 13 mile Rd</p>
<h3>Canton</h3> <p>WYNDCHASE Spacious 2 & 3 bedroom townhomes and apartments Garage Plymouth/Canton Schools</p> <p>From *1295* a month (734) 844-2400 Northeast corner of Cherry Hill & Haggerty Rd</p>	<h3>Novi</h3> <p>MAIN STREET VILLAGE 1,2 & 4 bedroom apartments and townhomes Attached 1/2 car garages Close to Twelve Oaks Mall Novi Town Center and Vic's Market</p> <p>From *1250* a month (248) 349-8400 Located off Grand River at Novi Rd</p>
<h3>Commerce/Novi</h3> <p>BRIARCLIFF VILLAGE 1 2 & 3 bedroom apartment homes 1/2 car attached garages Close to Novi Town Center and Twelve Oaks Mall</p> <p>From *1195* a month (248) 669-5900 On 14 Mile Rd East of Novi Rd</p>	<h3>Rochester Hills</h3> <p>NORTH RIDGE OF ROCHESTER 1 & 2 bedroom terraced apartments and townhomes Fireplace in select homes Close to downtown Rochester</p> <p>From *760* a month (248) 651-1091 Located on Avon Rd between Rochester Rd and Livernois Rd</p>
<h3>Downtown Northville</h3> <p>MAIN CENTRE Luxury 1 & 2 bedroom & loft apartments Close to shopping/dining and entertainment Located in downtown Northville</p> <p>From *950* a month (248) 347-6811 At the corner of Main and Center Streets, Northville</p>	<h3>West Bloomfield</h3> <p>COVE Luxury 2 bedroom apartment homes Attached garage Easy access to I 696 & M 5 connector</p> <p>From *1225* a month (248) 661-5870 On 14 Mile Rd just West of Halsted</p>

EOE www.singhapartments.com

THE APARTMENT SPECIALISTS

Bring in this ad for discount prices.

COUPON EXPIRES 9/30/01

<h3>Westland Parkcrest Apts</h3> <p>Designed with ROOMATES in MIND! Across from Meijers</p> <p>Livonia Schools (734) 522-3013</p>	<h3>Garden City Village Apts</h3> <p>FREE HEAT HUGE Bathrooms Bordering Westland</p> <p>(734) 425-0930</p>
<h3>Wilderness</h3> <p>SPACIOUS!! 2 B drms 1000 sq ft CARPORTS POOL WASHER & DRYER made unit</p> <p>Livonia Schools (734) 425-5731</p>	<h3>Luna Apts</h3> <p>Centrally Located to WESTLANDS shopping & business</p> <p>(734) 425-0930</p>
<h3>Carriage House</h3> <p>Enjoy quiet living! "Park Like" 1 & 2 Bedrooms</p> <p>(734) 425-0930</p>	

REDUCED PRICES ON ALL LOCATIONS!

734-451-5213 ginascap@aol.com

Concord Towers Apartments

Experience the Quiet, Convenience and Affordability of Concord Towers Apartments

We're minutes from Oakland Mall movie theaters several restaurants and I-75 and I-696 Our spacious and affordable apartment homes have plenty of room for everyone to be very comfortable Our distinctive one and two bedroom floorplans offer ceramic tile baths large living areas and all concrete construction for quiet living

Come Home to Concord Towers for Location, Quality and Affordability. 6 Month Leases Available

One bedroom from \$555
Two bedrooms from \$615

Features: • Storage in each apartment • Fully equipped kitchen with dishwasher & disposal • Fully carpeted • Cable TV available • Laundry on each floor • Central air • 24 hour emergency maintenance • Lighted carpets • Intercom entry system • Elevators

DIRECTIONS: We are located at 14 Mile and I 75 next to the Abbey Theater and directly across from Oakland Mall

Concord Towers Apartments

OFFICE HOURS: Mon-Fri 10-5 • Sat 10-1
(248) 589-3355

32600 Concord Dr. • Madison Heights

400 Apartments/Unfurnished

NOVI 2200 Sq ft 2 Bedrooms 2 baths Separate den plus a year round sun room filled with natural light Spectacular wooded and water views Short term leases available Great opportunity for corporate stay as well From \$1900/Mo Contact Cheri 248-348-7595

400 Apartments/Unfurnished

PLYMOUTH SQUARE APARTMENTS
Spacious 1 Bedroom from \$625 C/A Of Ann Arbor Rd 1 blk W of Sheldon 734-455-6570

400 Apartments/Unfurnished

Romulus RENOVATION BLOWOUT!
1/2 MONTH FREE
1 Bedroom from \$630 2 Bedroom from \$715

400 Apartments/Unfurnished

Westland Park Apts
Across from Garden City Park
Spacious 2 bedroom 1 1/2 bath 936 sq ft \$615
700 sq ft \$540

402 Condos/Townhouses

CLAWSON
N of 14 Mile & E of Crooks
Spacious 2 bedroom 1 1/2 bath townhouse Full basement with washer/dryer hookups fenced yard vertical blinds covered parking 1 cat OK with fee \$875 EHO Call weekdays for appointment
The Benecke Group
248-642-8686

405 Homes

AAA CREDIT or BAD CREDIT
Buy the home of your dreams for \$0-\$2850 down!
FOR THE LOWEST RATE IN TOWN
Call
ROBERT CLOUD
1-877-997-1608
Fairway of America Inc

405 Homes

FARMINGTON HILLS 2 bed room ranch on 3/4 acre large kitchen Available 9 15 \$875/mo 248-348-5100
RICHTER & ASSOC

405 Homes

PLYMOUTH 3 bedroom 1 bath C/A partially finished basement 2 1/2 car garage Available now! \$1,295
248-348-8189 #720
RICHTER & ASSOC

406 Lake/Waterfront Home Rentals

CLARKSTON/WATERFORD
New house 3 bedroom Many features \$3000/mo Option to buy (248) 623-0956

ORCHARD WOODS
Orchard Lake Rd Near Telegraph
One bedroom in quiet well maintained apt community Carpet Blinds & Heat Starting At \$495
248-334-1878

PLYMOUTH 1 bedroom heat included balcony storage air carpeted 1 Yr lease & security No pets \$550 248-474-2674

PLYMOUTH Cozy quiet 1 bedroom w/replace close to park & downtown No pets no smoking \$650 248-486-9393

PLYMOUTH Huge 1 bedroom 1 1/2 bath w/basement Washer/dryer hook up No pets no smoking \$675 248-486-9393

402 Condos/Townhouses

FOXPOINTE TOWNHOUSES
Beautiful 1500 sq ft 2 bed room 2 1/2 bath townhomes featuring large eat in kitchen walk in closets full size washer and dryer and storage area Car ports pool and tennis courts starting at just \$1225 per month
Call (248) 474-1127 or visit us daily at 26375 Halsted between 11 and 12 Mile in Farmington Hills

405 Homes

AUBURN HILLS 3 bedroom ranch fireplace fireplace 2 car garage \$900
RENTAL PROS (248)373-7373

405 Homes

BELLEVILLE Ranch w/3 bed room garage 2 1/2 bath Available 10 1 \$995
248-348-8189 #708
RICHTER & ASSOC

405 Homes

BERKLEY Charming 3 bed room 2 bath air 3 car garage fenced \$1450 Available Oct 1 (248) 224-9982

406 Lake/Waterfront Home Rentals

COMMERCIA LAKE
Super setting sandy all sports beach 2 bedrooms 2 full baths lots of glass for great view New Euro kitchen attached garage option possible \$1500

PLYMOUTH MANOR
PLYMOUTH HOUSE APARTMENTS
Newly Renovated 1 & 2 Bedrooms
734-455-3880

PLYMOUTH TWP 1 studio \$110/wk 1 Bedroom \$160/wk includes all utilities Country setting (313) 393-6396

\$ SPECIAL \$400* off
*on select units
Woodland Villa
Livonia Schools 2 Bedroom Apts Super Closets
Breakfast Bar Appliances Pool Laundry Facilities Lock Doors Intercom Cable Ready
Central Heating & Air Conditioning
Security Deposit \$400.00
734-422-5411
Warren Rd between Wayne & Newburgh
www.paragonapartment.com

WESTLAND WAYNE/FORD RD AREA
• Gas Heat No Charge
• Air Conditioning
• Laundry Facilities
1 & 2 BEDROOMS
1 BEDROOM START AT \$515 MONTHLY
(734) 721-0500

405 Homes

BIRMINGHAM Adams/Lincoln 2 bedroom 4 appliances large kitchen basement fenced yard a/c \$990 248-685-0190

405 Homes

BIRMINGHAM Adams/Lincoln 2 bedroom 4 appliances large kitchen basement fenced yard a/c \$990 248-685-0190

405 Homes

BIRMINGHAM Adams/Lincoln 2 bedroom 4 appliances large kitchen basement fenced yard a/c \$990 248-685-0190

405 Homes

BIRMINGHAM Adams/Lincoln 2 bedroom 4 appliances large kitchen basement fenced yard a/c \$990 248-685-0190

406 Lake/Waterfront Home Rentals

HOWELL Crooked Lake 3 bedroom brick 1 1/2 car garage 1 1/2 mo security Year lease Avail Sept 1 (517)545-8403

PLYMOUTH TWP 1 studio \$110/wk 1 Bedroom \$160/wk includes all utilities Country setting (313) 393-6396

Rochester Square Apts.
Located in Downtown Rochester
1 & 2 Bedrooms Avail
• Heat included
• Dishwasher
• A/C & Ceiling Fans
• Picnic area on Paint Creek
(248) 652-0543
Mon-Fri 9:30-6 Sat 10-4

FRANKLIN AREA WEATHERSTONE TOWNHOMES
Spacious 2 & 3 bedroom Townhomes Large eat in kitchen fireplace basement security system 2 car attached garage Secluded wooded setting convenient location
FROM \$1545/mo
Northwestern across from Franklin Racquet Club
CALL TODAY 248-350-1296

WESTLAND
Western Hills Apts
\$399 Moves You In 12 Month Lease Only 1 BEDROOM FROM \$540 2 BEDROOMS FROM \$605
FREE Heat & Water
734-729-6520
We're located on Cherry Hill between Wayne & Newburgh

405 Homes

BIRMINGHAM Arts & Crafts era home 2 bedrooms oak arched wood floors covered porches C/A full attic & base ment storage All appliances Pets welcome 1208 Emmons \$1250/mo 248-645-0459

405 Homes

BIRMINGHAM 3 bedrooms remodeled bath hardwood floors 2534 Buckingham \$1300 248-586-1308

405 Homes

BIRMINGHAM 1085 Bird 2 bedroom remodeled 1 car garage hardwood floors basement \$1075 248-618-8496

405 Homes

BIRMINGHAM Bungalow all appliances basement garage fenced new carpet \$900 RENTAL PROS (248)373-7373

406 Lake/Waterfront Home Rentals

INDIAN RIVER Luxurious accommodations for golf outing color tours holidays skiers Lakeland top lodge sleeps 16 4 bedrooms 4 baths hot tub sauna game room www.shuttledodge.com Call (888) 892-1297

PLYMOUTH Old Village Second floor Studio w/ small kitchen bath & appliances Washer/dryer available \$420 248-486-9393

PLYMOUTH TWP 1 studio \$110/wk 1 Bedroom \$160/wk includes all utilities Country setting (313) 393-6396

WESTLAND
Western Hills Apts
\$399 Moves You In 12 Month Lease Only 1 BEDROOM FROM \$540 2 BEDROOMS FROM \$605
FREE Heat & Water
734-729-6520
We're located on Cherry Hill between Wayne & Newburgh

405 Homes

BIRMINGHAM Arts & Crafts era home 2 bedrooms oak arched wood floors covered porches C/A full attic & base ment storage All appliances Pets welcome 1208 Emmons \$1250/mo 248-645-0459

405 Homes

BIRMINGHAM 3 bedrooms remodeled bath hardwood floors 2534 Buckingham \$1300 248-586-1308

405 Homes

BIRMINGHAM 1085 Bird 2 bedroom remodeled 1 car garage hardwood floors basement \$1075 248-618-8496

405 Homes

BIRMINGHAM Bungalow all appliances basement garage fenced new carpet \$900 RENTAL PROS (248)373-7373

405 Homes

BIRMINGHAM Arts & Crafts era home 2 bedrooms oak arched wood floors covered porches C/A full attic & base ment storage All appliances Pets welcome 1208 Emmons \$1250/mo 248-645-0459

406 Lake/Waterfront Home Rentals

INDIAN RIVER Luxurious accommodations for golf outing color tours holidays skiers Lakeland top lodge sleeps 16 4 bedrooms 4 baths hot tub sauna game room www.shuttledodge.com Call (888) 892-1297

\$200.00 Back to School Shopping Spree
Northville-Great Location
• 1 & 2 bedrooms
• Full size washer/dryers
• Vertical mini blinds
• Pool/Jacuzzi/Tennis Court
• Private entrances
• Fireplaces
• Carports
• Small pets welcome!

WESTWOOD VILLAGE APARTMENTS
(734)459-6600

S-T-R-E-T-C-H YOUR DOLLARS!
Get more luxury more comfort more convenience for less than you ever imagined! It pays to visit
WESTWOOD VILLAGE APARTMENTS
(734)459-6600

405 Homes

BIRMINGHAM Arts & Crafts era home 2 bedrooms oak arched wood floors covered porches C/A full attic & base ment storage All appliances Pets welcome 1208 Emmons \$1250/mo 248-645-0459

405 Homes

BIRMINGHAM 3 bedrooms remodeled bath hardwood floors 2534 Buckingham \$1300 248-586-1308

405 Homes

BIRMINGHAM 1085 Bird 2 bedroom remodeled 1 car garage hardwood floors basement \$1075 248-618-8496

405 Homes

BIRMINGHAM Bungalow all appliances basement garage fenced new carpet \$900 RENTAL PROS (248)373-7373

405 Homes

BIRMINGHAM Arts & Crafts era home 2 bedrooms oak arched wood floors covered porches C/A full attic & base ment storage All appliances Pets welcome 1208 Emmons \$1250/mo 248-645-0459

406 Lake/Waterfront Home Rentals

INDIAN RIVER Luxurious accommodations for golf outing color tours holidays skiers Lakeland top lodge sleeps 16 4 bedrooms 4 baths hot tub sauna game room www.shuttledodge.com Call (888) 892-1297

DEARBORN HEIGHTS AREA
Beautiful 1, 2 & 3 Bedroom 2 BEDROOM, 2 BATH VILLA
• 24 Hour Gatehouse
• Dishwasher
• Vertical Blinds
• Air Conditioning
• Fitness Center
• Tennis Courts
• Swimming Pool
• Furnished Apts Available
Open 7 Days Mon-Fri 9:00am-9:00pm Sat 9:00am-5:00pm Sun 12:00pm-5:00pm
BEECH DALY SOUTH OF CHERRY HILL
313-562-3988

DEARBORN HEIGHTS AREA
Beautiful 1, 2 & 3 Bedroom 2 BEDROOM, 2 BATH VILLA
• 24 Hour Gatehouse
• Dishwasher
• Vertical Blinds
• Air Conditioning
• Fitness Center
• Tennis Courts
• Swimming Pool
• Furnished Apts Available
Open 7 Days Mon-Fri 9:00am-9:00pm Sat 9:00am-5:00pm Sun 12:00pm-5:00pm
BEECH DALY SOUTH OF CHERRY HILL
313-562-3988

WESTWOOD VILLAGE APARTMENTS
(734)459-6600

405 Homes

BIRMINGHAM Arts & Crafts era home 2 bedrooms oak arched wood floors covered porches C/A full attic & base ment storage All appliances Pets welcome 1208 Emmons \$1250/mo 248-645-0459

405 Homes

BIRMINGHAM 3 bedrooms remodeled bath hardwood floors 2534 Buckingham \$1300 248-586-1308

405 Homes

BIRMINGHAM 1085 Bird 2 bedroom remodeled 1 car garage hardwood floors basement \$1075 248-618-8496

405 Homes

BIRMINGHAM Bungalow all appliances basement garage fenced new carpet \$900 RENTAL PROS (248)373-7373

405 Homes

BIRMINGHAM Arts & Crafts era home 2 bedrooms oak arched wood floors covered porches C/A full attic & base ment storage All appliances Pets welcome 1208 Emmons \$1250/mo 248-645-0459

406 Lake/Waterfront Home Rentals

INDIAN RIVER Luxurious accommodations for golf outing color tours holidays skiers Lakeland top lodge sleeps 16 4 bedrooms 4 baths hot tub sauna game room www.shuttledodge.com Call (888) 892-1297

DEARBORN HEIGHTS AREA
Beautiful 1, 2 & 3 Bedroom 2 BEDROOM, 2 BATH VILLA
• 24 Hour Gatehouse
• Dishwasher
• Vertical Blinds
• Air Conditioning
• Fitness Center
• Tennis Courts
• Swimming Pool
• Furnished Apts Available
Open 7 Days Mon-Fri 9:00am-9:00pm Sat 9:00am-5:00pm Sun 12:00pm-5:00pm
BEECH DALY SOUTH OF CHERRY HILL
313-562-3988

DEARBORN HEIGHTS AREA
Beautiful 1, 2 & 3 Bedroom 2 BEDROOM, 2 BATH VILLA
• 24 Hour Gatehouse
• Dishwasher
• Vertical Blinds
• Air Conditioning
• Fitness Center
• Tennis Courts
• Swimming Pool
• Furnished Apts Available
Open 7 Days Mon-Fri 9:00am-9:00pm Sat 9:00am-5:00pm Sun 12:00pm-5:00pm
BEECH DALY SOUTH OF CHERRY HILL
313-562-3988

WESTWOOD VILLAGE APARTMENTS
(734)459-6600

405 Homes

BIRMINGHAM Arts & Crafts era home 2 bedrooms oak arched wood floors covered porches C/A full attic & base ment storage All appliances Pets welcome 1208 Emmons \$1250/mo 248-645-0459

405 Homes

BIRMINGHAM 3 bedrooms remodeled bath hardwood floors 2534 Buckingham \$1300 248-586-1308

405 Homes

BIRMINGHAM 1085 Bird 2 bedroom remodeled 1 car garage hardwood floors basement \$1075 248-618-8496

405 Homes

BIRMINGHAM Bungalow all appliances basement garage fenced new carpet \$900 RENTAL PROS (248)373-7373

405 Homes

BIRMINGHAM Arts & Crafts era home 2 bedrooms oak arched wood floors covered porches C/A full attic & base ment storage All appliances Pets welcome 1208 Emmons \$1250/mo 248-645-0459

406 Lake/Waterfront Home Rentals

INDIAN RIVER Luxurious accommodations for golf outing color tours holidays skiers Lakeland top lodge sleeps 16 4 bedrooms 4 baths hot tub sauna game room www.shuttledodge.com Call (888) 892-1297

ARMENIAN SENIOR CITIZEN TOWER
located in Dearborn offers:
• Heat & Water included
• Newly renovated kitchens & baths
• Cable ready on is
• Wall to wall carpet
• Security entrance
• Elevator
• Bus service to & from shopping area
• Community room & activities
• Senior (62 or older) program
313-336-7404
Call between 10am & 4pm, Monday-Friday

ARMENIAN SENIOR CITIZEN TOWER
located in Dearborn offers:
• Heat & Water included
• Newly renovated kitchens & baths
• Cable ready on is
• Wall to wall carpet
• Security entrance
• Elevator
• Bus service to & from shopping area
• Community room & activities
• Senior (62 or older) program
313-336-7404
Call between 10am & 4pm, Monday-Friday

THREE OAKS APTS
WATTLERS (17 Mile) Btwn Crooks & Livernors 248-362-4088
• All electric kitchen
• Neutral Carpet
• Vertical Mini Blinds
• Storage Room
• Free Carport
• Pool Fitness Room & Tennis Courts
• Security deposit \$400
Ask About Our Specials!

405 Homes

BIRMINGHAM Arts & Crafts era home 2 bedrooms oak arched wood floors covered porches C/A full attic & base ment storage All appliances Pets welcome 1208 Emmons \$1250/mo 248-645-0459

405 Homes

BIRMINGHAM 3 bedrooms remodeled bath hardwood floors 2534 Buckingham \$1300 248-586-1308

405 Homes

BIRMINGHAM 1085 Bird 2 bedroom remodeled 1 car garage hardwood floors basement \$1075 248-618-8496

405 Homes

BIRMINGHAM Bungalow all appliances basement garage fenced new carpet \$900 RENTAL PROS (248)373-7373

405 Homes

BIRMINGHAM Arts & Crafts era home 2 bedrooms oak arched wood floors covered porches C/A full attic & base ment storage All appliances Pets welcome 1208 Emmons \$1250/mo 248-645-0459

406 Lake/Waterfront Home Rentals

INDIAN RIVER Luxurious accommodations for golf outing color tours holidays skiers Lakeland top lodge sleeps 16 4 bedrooms 4 baths hot tub sauna game room www.shuttledodge.com Call (888) 892-1297

CANTON
SPACIOUS 1 & 2 BEDROOM
• Washer/Dryer hook up
• Self-cleaning oven
• Vertical Blinds
• Swimming Pool
• New Fitness Center
• Pets Welcome
• Furnished Apts Available
From only \$635
Autumn Ridge APARTMENTS
Cherry Hill at I 275
734-397-1080
Open 7 Days Mon-Fri 9am-5pm Sat 9am-5pm Sun 12-5pm

CANTON
SPACIOUS 1 & 2 BEDROOM
• Washer/Dryer hook up
• Self-cleaning oven
• Vertical Blinds
• Swimming Pool
• New Fitness Center
• Pets Welcome
• Furnished Apts Available
From only \$635
Autumn Ridge APARTMENTS
Cherry Hill at I 275
734-397-1080
Open 7 Days Mon-Fri 9am-5pm Sat 9am-5pm Sun 12-5pm

WEST BLOOMFIELD
GET \$1,000 IN LEASE BUCKS!
Condo style 1 bedroom w/den & 2 bedrooms w/1 or 2 baths free touring private entrances attached garages full size washer/dryers in laundry room abundant storage & excellent West Bloomfield location
1 bedroom from \$848 2 bedroom from \$975
Call today for details (800) 566-8634
villagegreen.com EHO

405 Homes

BIRMINGHAM Arts & Crafts era home 2 bedrooms oak arched wood floors covered porches C/A full attic & base ment storage All appliances Pets welcome 1208 Emmons \$1250/mo 248-645-0459

405 Homes

BIRMINGHAM 3 bedrooms remodeled bath hardwood floors 2534 Buckingham \$1300 248-586-1308

405 Homes

BIRMINGHAM 1085 Bird 2 bedroom remodeled 1 car garage hardwood floors basement \$1075 248-618-8496

405 Homes

BIRMINGHAM Bungalow all appliances basement garage fenced new carpet \$900 RENTAL PROS (248)373-7373

405 Homes

BIRMINGHAM Arts & Crafts era home 2 bedrooms oak arched wood floors covered porches C/A full attic & base ment storage All appliances Pets welcome 1208 Emmons \$1250/mo 248-645-0459

406 Lake/Waterfront Home Rentals

INDIAN RIVER Luxurious accommodations for golf outing color tours holidays skiers Lakeland top lodge sleeps 16 4 bedrooms 4 baths hot tub sauna game room www.shuttledodge.com Call (888) 892-1297

W. BLOOMFIELD
FROM ONLY \$605
Orchard Lake & Middlebelt
BLOOMFIELD ON THE GREEN
• 1 & 2 Bedroom Apts
• Air Conditioning
• Pets Welcome
• Dishwasher
• Microwave
• Vertical Blinds
• Carports Available
• 2 Pools
• Fitness Center
• Furnished Apts Available
248-682-2950
OPEN 7 DAYS • MON-FRI 9am-9pm • SAT 9am-5pm • Sun 12-5pm

W. BLOOMFIELD
FROM ONLY \$605
Orchard Lake & Middlebelt
BLOOMFIELD ON THE GREEN
• 1 & 2 Bedroom Apts
• Air Conditioning
• Pets Welcome
• Dishwasher
• Microwave
• Vertical Blinds
• Carports Available
• 2 Pools
• Fitness Center
• Furnished Apts Available
248-682-2950
OPEN 7 DAYS • MON-FRI 9am-9pm • SAT 9am-5pm • Sun 12-5pm

WESTLAND BARCLAY HOUSE APTS
Extra large 1 bedroom Quiet clean Air heat appliances included \$500 810 229 8748

405 Homes

BIRMINGHAM Arts & Crafts era home 2 bedrooms oak arched wood floors covered porches C/A full attic & base ment storage All appliances Pets welcome 1208 Emmons \$1250/mo 248-645-0459

405 Homes

BIRMINGHAM 3 bedrooms remodeled bath hardwood floors 2534 Buckingham \$1300 248-586-1308

405 Homes

BIRMINGHAM 1085 Bird 2 bedroom remodeled 1 car garage hardwood floors basement \$1075 248-618-8496

405 Homes

BIRMINGHAM Bungalow all appliances basement garage fenced new carpet \$900 RENTAL PROS (248)373-7373

405 Homes

BIRMINGHAM Arts & Crafts era home 2 bedrooms oak arched wood floors covered porches C/A full attic & base ment storage All appliances Pets welcome 1208 Emmons \$1250/mo 248-645-0459

406 Lake/Waterfront Home Rentals

INDIAN RIVER Luxurious accommodations for golf outing color tours holidays skiers Lakeland top lodge sleeps 16 4 bedrooms 4 baths hot tub sauna game room www.shuttledodge.com Call (888) 892-1297

W. BLOOMFIELD
FROM ONLY \$605
Orchard Lake & Middlebelt
BLOOMFIELD ON THE GREEN
• 1 & 2 Bedroom Apts
• Air Conditioning
• Pets Welcome
• Dishwasher
• Microwave
• Vertical Blinds
• Carports Available
• 2 Pools
• Fitness Center
• Furnished Apts Available
248-682-2950
OPEN 7 DAYS • MON-FRI 9am-9pm • SAT 9am-5pm • Sun 12-5pm

W. BLOOMFIELD
FROM ONLY \$605
Orchard Lake & Middlebelt
BLOOMFIELD ON THE GREEN
• 1 & 2 Bedroom Apts
• Air Conditioning
• Pets Welcome
• Dishwasher
• Microwave
• Vertical Blinds
• Carports Available
• 2 Pools
• Fitness Center
• Furnished Apts Available
248-682-2950
OPEN 7 DAYS • MON-FRI 9am-9pm • SAT 9am-5pm • Sun 12-5pm

WESTLAND BARCLAY HOUSE APTS
Extra large 1 bedroom Quiet clean Air heat appliances included \$500 810 229 8748

405 Homes

BIRMINGHAM Arts & Crafts era home 2 bedrooms oak arched wood floors covered porches C/A full attic & base ment storage All appliances Pets welcome 1208 Emmons \$1250/mo 248-645-0459

405 Homes

BIRMINGHAM 3 bedrooms remodeled bath hardwood floors 2534 Buckingham \$1300 248-586-1308

405 Homes

BIRMINGHAM 1085 Bird 2 bedroom remodeled 1 car garage hardwood floors basement \$1075 248-618-8496

405 Homes

BIRMINGHAM Bungalow all appliances basement garage fenced new carpet \$900 RENTAL PROS (248)373-7373

405 Homes</

FINE HOMES & ESTATES



WEST BLOOMFIELD Views are stunning from this 4 bedroom, 3 bath colonial, completely rebuilt. All sports Cass Lake and lot frontage \$925,000 (65ISL) 248-642-8100



BLOOMFIELD Lovely soft contemporary sits on private 1.35 acre wooded lot. 4 BR, 3.2 BA finished walkout with rec room and possible 5th BR, 1st floor MBR, deck off kitchen/DR overlooking yard \$799,000 (80LON) 248-642-8100

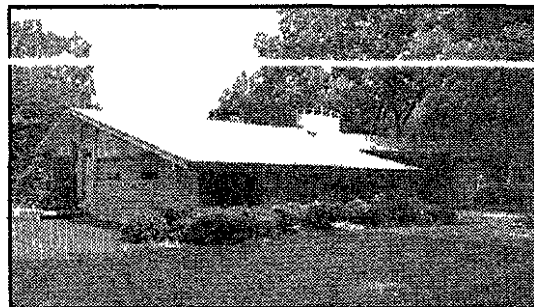

BLOOMFIELD Fabulous acre+ lot in an exceptional tranquil sub. Great walkout lower level, 1st floor laundry and very good open floor plan. Redecorate or rebuild lake privileges on Lower Long Lake \$534,900 (28MYS) 248-642-8100



WEST BLOOMFIELD Magnificent Chelsea Park home. 4 bedroom, 2 1/2 bath, built in '97 overlooking pond. 2 story ceilings and 3 car garage \$529,900 (53CLA) 248-642-8100



ORION Private retreat. Acreage on all sports Elkhorn Lake. Spectacular 4 bedroom, 3 1/2 bath, 1st floor master suite, large country kitchen with fireplace and Corian Florida room, full stone wall fireplace in great room \$595,000 (44CLA) 248-652-8000



ROCHESTER Luxurious spacious new home features 9 ceilings, gourmet kitchen with hardwood floors and white cabinets, library master suite with whirlpool tub and sitting room, 2 bedrooms share Jack-n-Jill bath \$519,900 (35KNO) 248-652-8000

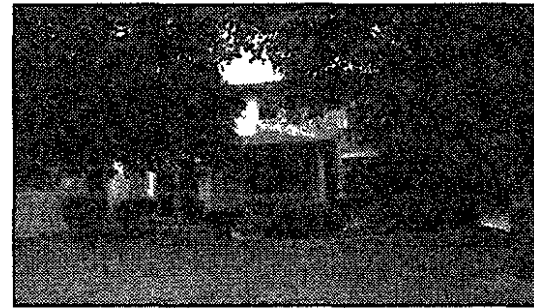

ROCHESTER HILLS Move-in condition. Updated and upgraded features on this lovely executive home. Circular staircase, 4 bedrooms, 2 1/2 baths, 2 tiered deck set on large private lot. Convenient to I-75 and M-59 \$384,900 (45STA) 248-652-8000



BIRMINGHAM Sharp. Very nice home in the heart of town. Beautiful hardwood floors, formal dining room, huge master with bath, cedar closet and lots of storage. Family room with gas fireplace, studio ceiling and doorwall \$339,899 (98HEN) 248-652-8000

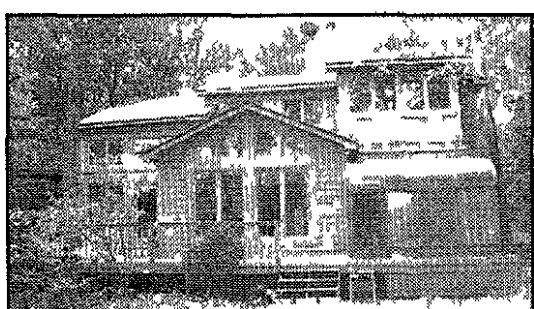

CASS LAKEFRONT! Fabulous 3 bedroom, 2 bath home. This home complete with charm. Updates galore! You must see this one! 1 year Home Warranty \$599,000 (49CHE) 248-626-8800



GORGEOUS NEWER HOME Well located in prestigious sub. Stunning 2 story foyer, high ceiling FR, hardwood foyer, kitchen, carpet, Jack & Jill bath, Dual staircase, MBR w/WIC, jetted tub, 4 BR, 3 1/2 BA colonial \$519,880 (30HED) 248-626-8800



FABULOUS COLONIAL 4 BR, 3 1/2 BA located in Chelsea Park. You won't go wrong with a wooded lot on a cul-de-sac location. Neutral and tastefully decorated. Finished walkout, 3 car garage. Why build when you can have all this? \$589,000 (65PEM) 248-626-8800



ALL SPORTS LAKEFRONT Designer decorated, pristine 4 bedroom lakefront home with top-scale touches like large view deck and entertainment area, 2 car garage, large rooms and walk-in closets, 2 fireplaces and office \$449,900 (48BIS) 363-1200

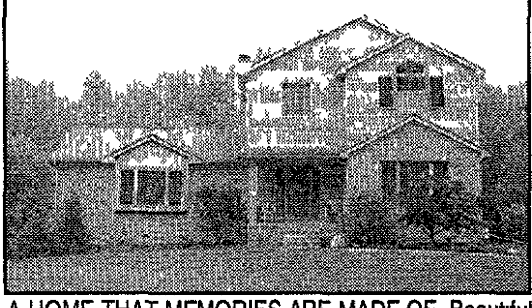

A HOME THAT MEMORIES ARE MADE OF Beautiful well appointed newer home with 3 BR, 3 BA, huge 3+ car garage and full basement, custom cabinets, hardwood and ceramic floors, vaulted ceilings. Approx 1/2 acre lot \$379,900 (87TRE) 363-1200



ELEGANT 1870 COLONIAL Change in our lives is inevitable, and yet we strive to create things that last. A comfortable and beautiful home that brings happiness and fulfillment. 4 BR, 3 BA, gourmet kitchen w/Corian FR, library and 3 car garage \$699,900 (35CEN) 248-349-5600



NORTHVILLE TWP FARMHOUSE Approx 100 year old home on 1 1/2 acres! 3 bedrooms, 2 baths and room to room! Newer vinyl siding, A/C and copper plumbing. Fireplace in living room with parlor, Mud room \$329,900 (00SEV) 734-455-5600

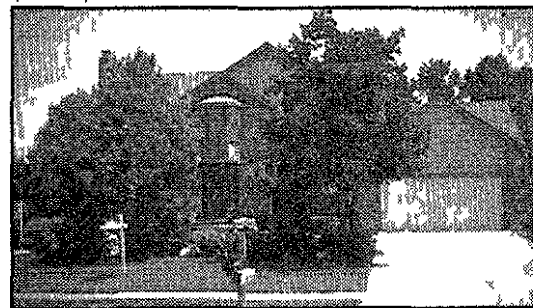

THIS HOUSE HAS IT ALL AND MORE! 4 BR, 2 1/2 BA, lovely large kitchen w/cherry cabs, 1st floor laundry, 3 fireplaces, finished basement, glass block windows, Newer Andersen windows, Nice back yard and large deck to commons \$407,500 (10NOR) 734-455-5600



CLASSIC HOME EXEMPLARY UPGRADES! 2 story foyer, Hardwood floors in foyer, kitchen, powder room, Formal DR, FR w/tray ceiling, crown moldings, library w/built ins, Gourmet kitchen w/custom cabinets, desk bay window \$519,900 (21HIL) 734-455-5600



MAGNIFICENT ESTATE ON 10 ACRES! Rolling land and 2 ponds! Spectacular 2 1/2 story brick home. Finished walkout w/full studio apartment, FR with great view! 2 fireplaces, 3rd floor study/loft, Glorious master suite with spa and 2 walk in closets and fireplace \$840,000 (72GRA) 734-455-5600

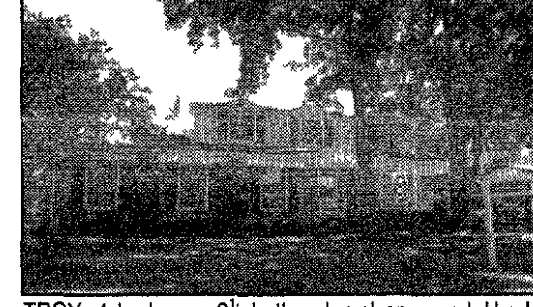

TROY 4 bedroom, 2 1/2 bath colonial on a park-like lot with library, dining room, 1st floor laundry and family room with cathedral ceilings. Newer roof and many windows. Troy schools. Immediate occupancy \$359,900 (16PAR) 248-524-1600



BLOOMFIELD HILLS Elegant entertaining in this 1st floor master condo with 3 bedrooms, 2 1/2 baths, 2 car attached garage, basement and bright kitchen with view of the courtyard. Library with fireplace \$459,900 (27ARB) 248-524-1600



WATERFORD All sports lakefront home with 1st floor master bedroom, library, finished walk out basement and 3 car garage all on approximately one acre lot with dock. Private road. Don't wait! \$579,800 (72WIL) 248-524-1600



ROCHESTER HILLS Stunning inside and out. 4 bedroom, 2 1/2 bath colonial with spacious formal dining room, large master suite and gorgeous island kitchen. Large paver patio with pond from walk out basement \$329,900 (59DEV) 248-524-1600

America's #1 CENTURY 21 Firm!



HIGHLAND TOWNSHIP'S MOST DESIRABLE COMMUNITY Prestwick Village with luxurious golf course front ranch with finished LL. Impressive list of custom options. Gorgeous master suite overlooks in-ground pool \$795,000 (64PER) 248-626-8800



A DREAM COME TRUE 4 bedroom, 4 1/2 bath custom estate home in Bogie Lake Estates. Gourmet kitchen w/hardwood floors & granite countertop, crown molding, 2 fireplaces, custom bar, huge garage approx 1 acre on golf course \$549,900 (00COO) 363-1200



GOLFER'S PARADISE Gorgeous golf front custom contemporary 4/2 1/2, 1st floor MBR w/2-way FP, White kitchen, butler's bar, cathedral ceiling in GR w/power chandelier, lift 3+ car garage, FFL library/study, A/C sprinklers \$519,900 (95PPE) 363-1200



FANTASTIC 1989 BUILT COLONIAL that is totally new inside and out and ready to move into. The 4 BR, 2 1/2 BA home is located at the entrance of a cul de sac setting. Finished lower level w/playroom and separate office/exercise room \$369,900 (60LIT) 248-349-5600



FOXPOINTE COLONIAL 4 bedroom, 2 1/2 bath, great room, sunroom/family room, 3 car garage, partially finished walk-out lower level, large deck, private yard with fish pond. Plymouth-Canton schools. Very impressive \$485,000 (38FOX) 248-349-5600

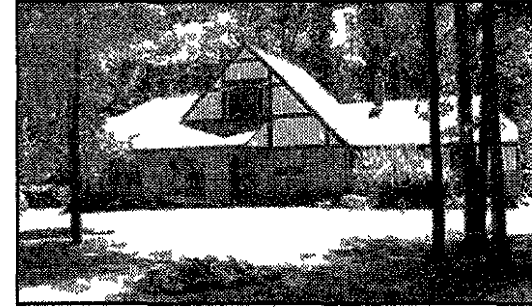

COUNTRY SETTING/WOODED Heavily wooded paradise only begins to describe this custom built Tudor tucked away in a very secluded setting. Professionally finished lower level, Florida room, 2 way fireplace, Charming & updated \$312,900 (15NIN) 248-349-5600

294 E. Brown, Birmingham (248) 642-8100 | 4820 Rochester Road, Troy (248) 524-1600 | 2600 Union Lake, Commerce Twp. (248) 363-1200 | 722 W. University, Rochester (248) 652-8000 | 7125 Orchard Lake, West Bloomfield (248) 626-8800 | 705 S. Main St., Plymouth (734) 455-5600 | 175 Cady Centre, Northville (248) 349-5600

Website: <http://www.century21town-country.com>

• Complete Home Marketing Plan • Home Warranty Program • Local & Regional Multiple Listing Services
• Full-Service Relocation Services 1(800)448-5817 • Financing Services (810) 264-5400



NEW HOMES & REAL ESTATE

Sunday, September 9, 2001

RealEstate Ad Index

CLASSIFICATION	NUMBER
Real Estate For Sale	300-388
Homes For Sale By City	304-348
Homes For Sale By County	352-357
Misc Real Estate	358-388
Commercial/Industrial	390-398
Real Estate For Rent	400-444

Our complete index can be found inside this section

HOME SEEKER'S CHECK LIST

- SELLER DISCLOSURE STATEMENT (REQUIRED BY LAW)
- LEAD DISCLOSURE STATEMENT (REQUIRED BY LAW)
- HOUSE SPEC SUMMARY SHEET (ROOM DIMENSIONS ETC)
- SCHOOL DISTRICT SERVICING NEIGHBORHOOD (WHERE EXACTLY ARE BUILDINGS BUS PICK UP)
- AGE OF MAJOR MECHANICAL/ STRUCTURAL COMPONENTS (FURNACE HOT WATER HEATER SHINGLES ETC)
- APPLIANCES INCLUDED?
- PROPERTY TAXES (BASED ON SELLING PRICE, NOT CURRENT RECORDS)
- MUNICIPAL SERVICES PROVIDED (TRASH COLLECTION LEAF PICK UP SNOW REMOVAL LIBRARY)
- CONDITION OF NEIGHBORING PROPERTIES

lets you view property listings on your home computer!
REALnet
REALnet is the address used by Observer & Eccentric advertisers.

Access REALnet at
<http://oeonline.com/REALnet.html>
To order Observer & Eccentric On Line call 734 953 2297 and get the software that will open the doors to REALnet

See our New Homes Directory for the latest in home construction

Canton condos avoid cookie-cutter look

Nearly a third of the 88 attached condominiums at Morgan Creek in Canton have sold since the models there opened four months ago.

And for good reasons, too, according to folks affiliated with Curtis Building and Kaftan Enterprises, which have teamed to shape the community on Cherry Hill between Lilley and Sheldon roads.

"The quick and easy answer is our units are marketable to anybody," said Craig Menuck, partner with Curtis Building. "We have younger married couples, older married couples with children. We have singles. The intention has proven true. It's tailored for anybody."

"Making it affordable has only helped," Menuck added.

Base prices start at \$186,990 for a two-story of 1,303 square feet with two bedrooms and 2-1/2 baths and go up to \$203,990 for a story-and-a-half with three bedrooms, 4-1/2 baths and 1,000 square feet of living space.

"I think it's a very good value for Canton," said Jeffrey Kaftan, vice president with Kaftan Enterprises. "We built the same product in Saratoga Farms in Farmington Hills in 1997. We sold 155 units in less than two years."

There are other pluses to the development.

Open space

"Based on what you get nowadays where they kind of squeeze more units on less land, here, it's less dense," Kaftan said.

"We do have a 20-acre nature preserve back there and little Morgan Creek," said Art Anderson, sales representative. "We're going to put a little bridge up."

"It's an excellent location," Anderson added. "It's five minutes from the expressway system, 20 minutes from the airport. We're split between Ann Arbor and Detroit."

"You have all the services in the community near, whether it be health care or shopping," he said.

Then, there's the reputation of the builders, Anderson added. "That in itself draws the public."

Curtis has been around 57 years, Kaftan 35, the principals said.

A pair of two-story plans, each with a two or three bedroom option, and a first floor master that can be built as a three bedroom or two bedrooms with loft, are available.



Morgan Creek: Purchasers of these attached condominiums can select either a two-story or story-and-a-half look with two or three bedrooms.

A two-car garage, first-floor laundry, basement, 2-1/2 baths (with pedestal sink in the powder room), range and dishwasher in the kitchen, ceramic or wood flooring in the foyer and half bath, and carpeting throughout are standard features at base price in all three.

A 10-year warranty is provided on basement waterproofing.

A gas-vented fireplace (\$2,570), air conditioning (\$2,550) and a 12-by-12 deck (\$2,825) are upgrades.

The story-and-a-half, available as an end-unit only, has been built as a model.

The home contains a great room with sloped ceiling, kitchen/nook with island, and master with cathedral ceiling, walk-in closet and shower on the main floor.

Two bedrooms and a full bath with combination tub/shower are upstairs.

Base price is \$203,900. The model has about \$10,000 worth of upgrades.

Loft option

The same home is available with a loft replacing one of the upstairs bedrooms. The trade off is 99 less square feet overall and a flat ceiling in the

master for a base price reduction of \$3,000 from the three-bedroom plan.

Landscaping is included. Brick and vinyl siding are primary exterior materials.

Homes are clustered together in groups of two to five per building.

Morgan Creek is served by city water and sewers. It's within the Plymouth Canton school boundaries. There are no sidewalks.

The property tax rate is \$31.83 per \$1,000 of state taxable value, half of sales price for new construction. That means the owners of a \$195,000 home there would pay about \$3,100 the first year.

The monthly association fee which includes water, is \$118.

Tom and Kim Digho ordered a two-story and moved a wall between the kitchen and family room to add a three-way fireplace.

"I liked the plan for what we could do with it," Tom said. "I personally know the builder and developer. The customer also comes first with them."

"Canton is a booming area," he added. "It will be quiet serene with the woods and 20 acres (natural area)."

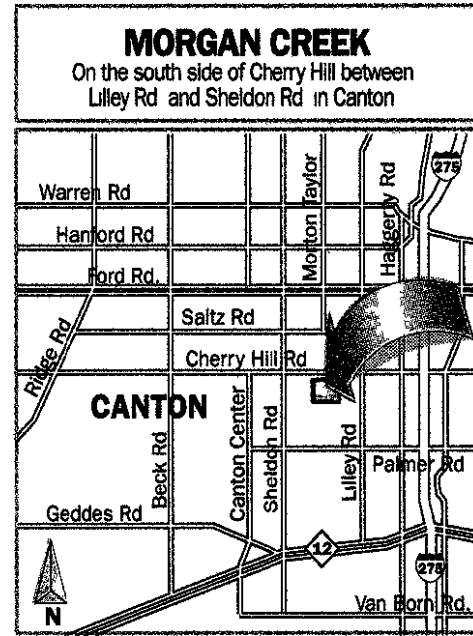

The sales models/office at Morgan Creek (734) 983 9111 is open noon to 6 p.m. daily closed Thursdays

hometownnewspapers.net

Barry Jensen, Editor 734-953-2125

bjensen@homecomm.net

OPEN HOUSES OF THE WEEK

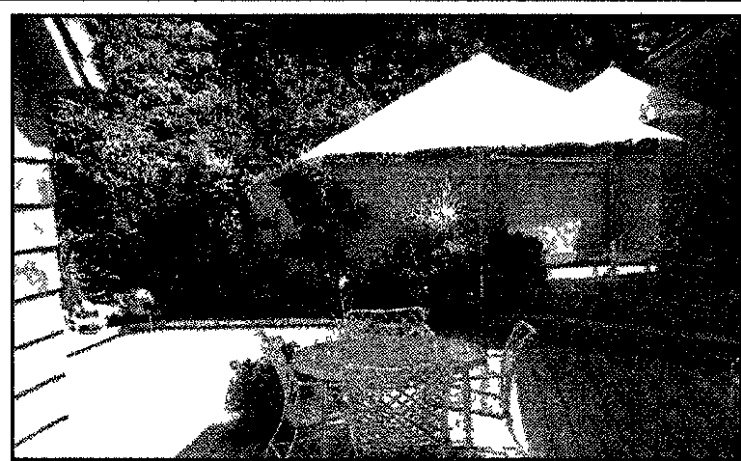

945 Bloomfield Woods Drive Bloomfield Hills N. of Long Lake, W. off Woodward

OPEN SUNDAY 1-4:00
\$1,490,000

Private Retreat in the City

If you want a serene atmosphere this site condominium is the one. Surrounded by trees and lush landscaping, all views from every window are spectacular. Upon entering the gate you are greeted by an azure exercise pool in the midst of decking, flowers, and greenery. Step into the home and you'll find soaring light-filled rooms exquisitely decorated and maintained.

The house has a comfortable 4,000 sq ft on three levels with an attached garage. All required facilities are on the entry level: large entryway master bedroom suite, library, open kitchen, spacious dining area, living room with custom fireplace, laundry room and garage. Five sliding glass doors and three private decks invite you outdoors. The master suite consists of a king sized bedroom with fireplace, dressing room with a skylight, double

basin vanity for her, single basin for him, four closets, fully tiled bath with Jacuzzi tub and separate shower, and a private outdoor sunning/meditation court.

The lower level is a walkout with two bedrooms, family room with fireplace, island kitchenette/bar, exercise area, two storage rooms, utility room, and fireproof vault/wine cellar. This level can be closed off and has a private entrance. The third level is for guests with a bedroom bath, two closets and attic storage.

There are so many special touches to this home. One of the developers of Bloomfield Woods selected this site for himself and put only the "best" in his home from the specially commissioned Glen Michaels fireplace wall structure to the New Zealand wool carpet to the "Caribbean Clear" silver/copper ionizing system which makes the pool chlorine free. Everything has been carefully planned and thought out. Please don't miss spending part of your afternoon at this quiet retreat in the City of Bloomfield Hills.

For information call

RONNI KEATING
248-330-9750 or 248-644-7000
Web Site: www.ronnikeating.com
Snyder, Kinney, Bennett & Keating, Inc.



Hickory Ridge Condominiums for Senior Citizens Cluster Ranch Condos Approx. 1,200 sq. ft.

Starting in the \$150's
Standard items include:

- ◆ Full Basement
- ◆ 10' x 12' deck
- ◆ Hi-efficiency furnace & water heater
- ◆ Merrill cabinets
- ◆ Tile in bathrooms & foyer
- ◆ Dishwasher & hood fan
- ◆ 1st floor laundry w/tub
- ◆ Cathedral ceiling in great room & master bedroom
- ◆ Low-E insulated windows
- ◆ 1/2-HP garage door opener
- ◆ Gutters & down spouts
- ◆ 2 full baths
- ◆ 3 Dimensional Shingles
- ◆ Brick on all 4 sides
- ◆ Attached Garage
- ◆ Delta kitchen & bath fixtures
- ◆ Phone & cable jacks
- ◆ Gas line for stove & dryer
- ◆ Copper line for ice maker
- ◆ Kwikset TiTAN lock sets
- ◆ Carpet on basement steps
- ◆ Tyvek house wrap
- ◆ Underground sprinkler system & professional landscaping
- ◆ Insulated garage door
- ◆ Individual mail boxes
- ◆ Full glass w/brass storm door
- ◆ Air conditioning

CALL
LARRY HENNEY
(734) 432-1010

Models open daily 1 p.m. - 5 p.m. Closed Thursdays
(734) 422-2577

Located in North Dearborn Heights on Inkster Road between Ford & Warren



RE/MAX



Custom Homes Feature Luxury Amenities

"Distinctive Details"

The basic fundamental of all Cambridge Homes custom homes is superior craftsmanship, from the solid foundation to the hand-rubbed finishes, only the highest quality materials and fixtures are selected. Attention is paid to the smallest of details, nothing is overlooked. The result the home you've always imagined, a home of comfort, style and elegance.

Now, Cambridge Homes is collaborating with some of the finest architects and interior designers in the area to work with homebuyers in designing one-of-a-kind homes for their newest development Bellagio in Oakland County's premier gated community of custom homes. Each unique home reflects the personality of its owners, creating a prestigious neighborhood rich with architectural diversity.

After years of appreciating old world craftsmanship, Mark and Eric Guidobono of Cambridge Homes are bringing the grandeur and classic beauty found in European architecture to Bellagio. Distinctive elements, including carved lime

stone facades, blacksmith-crafted ironwork accents, and leaded glass windows are reminiscent of magnificent country estates. Modern luxuries are available as well. A home theater, wine cellar, solarium, and indoor pool are all possible amenities in your Bellagio home.

Over the past 20 years, Cambridge Homes has become an expert at making the design/build experience exciting and positive by focusing on homeowner participation. We've made a commitment to individuality, quality and creativity, says Mark. As evident in their previous custom home projects and in their Woods of Edenderry development in Northville, these are not your average home builders, they are inspired craftsmen. Bellagio is certain to be their ultimate accomplishment.

Reservations are now being accepted. For more information, contact:
Cambridge Homes
(248) 348-3800

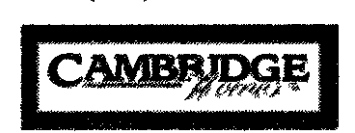

Think about investing tax rebate on home

You probably have recently received or soon will get a tax refund. Here's a not-so-subtle reminder from your local retailer: "We will cash your tax rebate check, free of charge, with any purchase."

Despite the blizzard of ad pitches trying to tell you where to spend your tax rebate, of course it's up to you.

"With these tax rebates ranging from a maximum of \$300 to \$600, just one stop at the home improvement center is enough to make the money disappear," says Richard Roll, president of American Homeowners Association. "But homeowners have ways to invest it that could yield positive benefits in their homes or communities."

How much money can you expect, and when? According to the IRS, the refund checks range from up to \$300 for a single taxpayer, \$500 for heads of households and \$600 for a married couple filing jointly.

Checks started hitting the mail in late July. Depending on the taxpayer's Social Security number, all will have been mailed by late September, most at mid-

Local charities are making a case for making a little money go a long way.

United Way, for example, says that \$600 provides 3 1/2 months of transportation for six elderly and disabled people for medical appointments and grocery shopping, or a year of academic support to prevent an at-risk youth from dropping out.

Some retailers are offering to cash IRS checks with any purchase from the store. If you cash in at the local home improvement center, consider investing in energy efficiency. You could lower your utility bills and help improve the environment at the same time.

Proper insulation cuts down on both heating and cooling costs and offers the additional benefit of noise control. Air leaks around windows and doors can account for up to 30 percent of a home's wasted energy.

Proper caulking and weather-stripping can help increase energy savings by up to 10 percent, while storm windows and doors or double-paned windows can cut heat loss at those sites in half.

Buying energy-efficient fluorescent light bulbs also cuts your electricity consumption substantially.

For more information on any aspect of buying or owning a home, go to www.realhome.com or www.ahahome.com.

The Weekly Do-It-Yourselfer

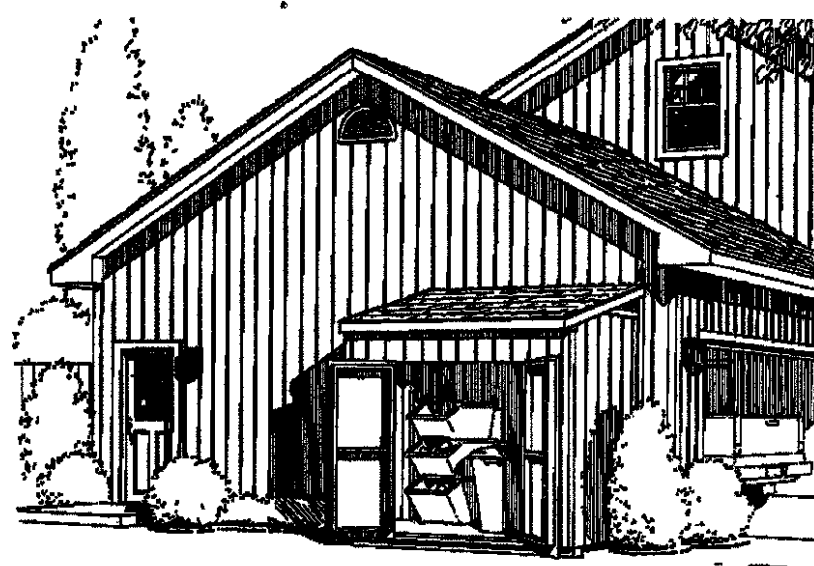

Lean-To Shed

So recycling has finally arrived. Now, how do you store the recyclables? The featured Lean-To Shed can solve this problem, easily and conveniently. Or, maybe, you just need a storage area for the children's bicycles or the lawn mower and yard tools. This easy-to-build shed is worth your consideration.

There is an optional screened vent at the gabled ends. The large double door gives you easy access. It is a free

standing design, yet it can be attached to your home. Two complete sets of the plans are included: one for you or your builder and one for the building department. Plans include clearly labeled, detailed drawings along with full framing instructions. Illustrations are drawn three dimensionally with full elevations and cross sectional diagrams. Step-by-step comprehensive instructions are included, as is a full materials list.

Send me the Project Plan #90031 Construction Package (ready-to-build blueprints). Includes 2 prints and complete materials list . . . \$15.40.

Name _____
 Address _____
 City _____ State _____ ZIP _____
 Phone () _____

Fill out info above and make check or money order payable to and send to The Garlinghouse Co., Dept OEC, 174 Oakwood Drive, Glastonbury CT 06033

Communities of Distinction

CA. KIME INC.

1 Van Buren Twp. Greenbriar

Single Family Homes from \$173,990
 1600-2300 sf
 3 & 4 Bedrooms
 80 foot lots

Call Mark 734-697-4094
 Located on the Southeast Corner of Belleville Road & Van Born Road



2 Van Buren Twp. Wildbrook

Single Family Homes from \$193,990
 1900-2400 sf,
 3 & 4 Bedrooms
 80 foot lots

Call Linda 734-697-1555
 South side of Savage Road between Haggerty & Martinsville Roads

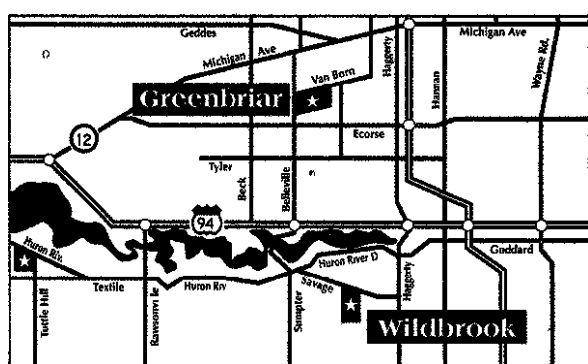

Visit our website at cakime.com



Unmistakably Robertson Brothers...

Come Experience **Golf Course Community Living** Nestled in a **Secluded Setting**

Condominiums in Canton

Specializing in creating lifestyles you can live in— for over 55 years.

We've saved the best for last — only 30 condominiums remain!

All the remaining condominiums back up to a golf course wetlands area or pond. Standard features include a full basement two-car attached garage, first floor laundry room, a large deck, central air and more. Floor plans range in size from 1,700 to 2,100 square feet. Two of the three floor plans have a first floor master suite. Don't miss out on this great opportunity to live in one of Canton's most unique communities!

The Links West of Pheasant Run

Priced from the mid \$200,000's to the low \$300,000's
 Call (734) 394-0442 for more information

Robertson Brothers Rb
 Community Builders

www.robertsonbrothers.com
 Open Thursdays • Brokers Welcome
 Open Daily Noon to 6pm

Equal Housing Opportunity
 Prices and availability subject to change without notice

55 New Homes Built by the Professional Master Builders of Building Industry Association of Southeastern Michigan.

Visit These Builders August 23 - September 23 or online at www.builders.org

Showcase of **DISTINCTIVE Homes**

CITY	BUILDER	PRICE	PHONE	CITY	BUILDER	PRICE	PHONE
NORTHWEST				CENTRAL (continued)			
Howell/Brighton	Ivanhoe-Huntley	\$269,900	(248) 626-1109	Farmington Hills	Millicreek Building Co.	\$539,800	(248) 442-2566
Hartland	Paradigm Building Co., Inc.	\$383,700	(617) 545-1509	Novi	Singh Homes, L.L.C.	\$550,000	(248) 471-6844
Fenton	Paradigm Building Co., Inc.	\$399,000	(610) 923-5446	West Bloomfield	Ivanhoe-Huntley	\$582,900	(248) 626-1180
South Lyon	Homestowne Building Co.	\$399,900	(248) 446-1439	Novi	John Richards Homes	\$987,000	(248) 380-8882
SOUTHWEST				Bloomfield Hills	BRG Custom Homes	\$1,686,000	(248) 659-3880
Ypsilanti Township	Curtis/Greene Farms, L.L.C./Livona Builders	\$231,900	(734) 482-1220	Novi	Cambridge Homes	\$3,280,000	(248) 348-3880
Belleville	Kheder Development, Inc.	\$235,900	(734) 698-5888	DOWNRIVER			
Van Buren/Belleville	Homestowne Building Co.	\$248,900	(734) 698-7490	Trenton	Unland Corp	\$209,385	(734) 671-5600
Canton	Ivanhoe-Huntley	\$418,700	(734) 687-3590	Brownstown	Westminster Abbey Homes	\$252,890	(734) 783-5851
Ann Arbor	Cohenhomes.com	\$415,000	(734) 976-1150	Brownstown	Fountain Homes	\$259,900	(734) 379-2507
Canton Township	Curtis-Kirkway, L.L.C.	\$443,045	(734) 844-2230	NORTHEAST			
Plymouth	Huntington Park Homes of Plymouth L.L.C.	\$463,800	(734) 454-5518	Davison Twp	Country Club Meadows	\$174,800	(810) 664-9888
Northville Township	Wineman & Komer Bldg Co./Curtis Bldg Co./Millicreek Bldg Co	\$864,900	(734) 667-3400	Richmond	Garden Grove Park Dev. Corp	\$183,500	(810) 727-6400
Northville	Cohenhomes.com	\$1,200,000	(734) 420-1147	Richmond	Swan Creek Homes Dev. Corp	\$209,000	(810) 727-6400
CENTRAL				Oxford	MJC/Ivanhoe-Huntley	\$234,900	(248) 236-9332
Royal Oak	MacLish Building	\$348,900	(248) 624-3244	Chesterfield	Cantara Homes, Inc.	\$299,000	(810) 948-3752
Westland	Singh Homes L.L.C.	\$338,900	(248) 624-8600	Lake Orion	Wineman & Komer Building Co	\$320,775	(248) 381-2623
Commerce	Homestowne Building Co.	\$348,900	(248) 366-1980	Washington Twp	Saylor Building Company	\$331,000	(248) 624-2850
White Lake	Heritage-Nissan Homes L.L.C.	\$350,000	(248) 698-3011	Oxford	Boulder Pointe Homes	\$409,800	(248) 989-4180
Rochester	Orloff Homes	\$378,900	(248) 801-3539	Independence Twp	Cohenhomes.com	\$475,000	(248) 922-9270
White Lake Township	Cohenhomes.com	\$405,000	(248) 688-1714	Oakland Twp	The Beneficio Group	\$539,000	(248) 814-7880
Farmington Hills	Homestowne Building Co.	\$408,900	(248) 665-2812	Metamora	Mt. Christe Estates	\$695,000	(248) 989-0400
West Bloomfield	Ivanhoe-Huntley	\$464,000	(248) 788-9585	Clarkston	Thomas Seboid & Associates & Victor Properties	\$710,000	(248) 922-9100
Novi	Singh Tollgate Revenues L.L.C.	\$499,900	(248) 926-8866	Independence Twp	John Richards Homes	\$778,850	(248) 383-4425
UNITY PARK - PONTIAC				Clarkston	Thomas Seboid & Associates & Victor Properties	\$1,289,000	(248) 922-9100

Home Builders Care: Unity Park

Partners in revitalizing an older neighborhood in Pontiac

As part of the nationwide Home Builders Care program, Building Industry Association of Southeastern Michigan has partnered with Standard Federal Bank and Lighthouse Community Development to build ten new homes in Unity Park, an older neighborhood in Pontiac. BIA has provided \$25,000 in funding for the program, as well as gathering the professional master builders to construct the homes and publicizing their efforts in the Showcase of Distinctive Homes.

Pontiac	Ambassador Building Co.	\$120,000	(248) 920-8080 x2400	Pontiac	Russo Building Co.	\$120,000	(248) 920-8080 x2400
Pontiac	Carabelli Construction Inc.	\$120,000	(248) 920-8080 x2400	Pontiac	Saylor Building Co.	\$120,000	(248) 920-8080 x2400
Pontiac	Kelray Construction Inc.	\$120,000	(248) 920-8080 x2400	Pontiac	Skyler Group	\$120,000	(248) 920-8080 x2400
Pontiac	Kelray Construction Inc.	\$120,000	(248) 920-8080 x2400	Pontiac	Skyler Group	\$120,000	(248) 920-8080 x2400
Pontiac	PAZ Homes	\$120,000	(248) 920-8080 x2400	Pontiac	West Construction Services	\$120,000	(248) 920-8080 x2400

Sponsored by:

www.builders.org

Guide explains financial aspects of home ownership

Buying a home is a major investment that requires a lot of decision-making. But the decisions don't stop once you've moved in.

What type of homeowners insurance will best suit your needs? What if you need some extra cash down the line - should you use your home to apply for a line of credit? How does it work?

Here's some help for each step of the way.

Get the facts on everything from buying your home and insuring it to applying for a home equity line of credit with a new package of publications from the Federal Consumer Information Center.

Learn about mortgage insurance, how to qualify for a low down payment loan, and how to calculate how much home you can afford with How to Buy a Home With a Low Down Payment from the Mortgage Insurance Companies of

America and the Cooperative State Research, Education and Extension Service of the United States Department of Agriculture.

Use the guide's handy worksheet to evaluate your financial resources and determine what kind of house fits your budget. Once you've found your dream home, get the facts on insuring it with Twelve Ways to Lower Your Homeowners Insurance Costs from the Insurance Information Institute.

Find out how taking steps as simple as raising your deductible or upgrading your door locks can reduce your insurance costs.

If you're considering applying for a home equity line of credit, use When Your Home Is on the Line What You Should Know About Home Equity Line of Credit from the Federal Reserve Board to find out which plan is best for you.

Learn about how a home equity line of credit works, the costs involved, how home equity plans are repaid, and how they compare to second mortgage loans.

This guide also includes a checklist to help you compare plans and a helpful glossary of terms.

Learn more with the "Your Home and Money" package. This package costs \$1 and there are three easy ways to get it:

■ Call toll-free (888) 8 PUEBLO. That's (888) 878-3256, weekdays 9 a.m. to 8 p.m. and ask for the "Your Home and Money" package. Have your credit card handy.

■ Send your name, address and a check or money order for \$1 to Your Home and Money, Pueblo, CO 81009.

■ Visit www.pueblo.gsa.gov and read or print these and hundreds of other FCIC publications for free.

Prep work precedes painting

BY POPULAR MECHANICS FOR AP SPECIAL FEATURES

Painting windows requires special preparation and techniques because of their glass and open-and-close operation.

To protect the glass, you can use masking tape or a wipe-on protective film that's dispensed much like deodorant.

Another option is to skip this step and scrape off any paint from the glass with a razor. It's a case of spending your time masking or scraping.

Apply the tape or film only after thoroughly dusting the corners of each window pane. The crevice tool of a vacuum works well to do this.

If you paint the windows without tape or film, you can use a trim guard to protect the glass area. These come either as a triangular shaped piece of metal or a metal strip with a plastic handle. On bare wood windows, allow some paint to seal against the glass.

When it comes to removing hardware, punts will tell you to remove

it before painting. But this is not always practicable.

If a window lock is covered by several layers of paint but works properly, decide how much time you want to spend on the window. You will crack the existing paint if you remove the lock, and this also leaves a dent in the paint the shape of the lock. Unless you replace it with the same type, you will have to sand away the paint buildup in this area. If the hardware is not painted, it may be easier to remove it rather than paint around it.

Paint windows from the inside out. Begin painting the thin vertical and horizontal dividers between the panes in double hung windows. The same holds true for casement windows.

If your window has a removable window grille, take it out for a much easier job. Use a 1 1/2 inch-wide sash brush, and don't drag your brush back across the edge because this will cause a run in the paint.

If you are painting a double hung window and the upper sash is mov-

able, reverse the position of the inner or lower sash and the outer or upper sash. Paint the lower half of the outer sash first, then paint the inside sash. But don't do the top edge where the lock is. Save that until last.

Return the sashes to their normal positions, but don't close the window completely. Then paint the top of the outer sash and the top edge of the inner sash.

Switch to a 2 1/2-half-inch wide brush and paint the window frame from the inside out, moving the sash cord, if there is one, out of the way to avoid getting paint on it.

Next, paint the window casing. Cut in a nice, clean line where the casing meets the wall. Then paint the sill and the apron, which is the trim beneath the sill. When the paint is dry, scrape it off the glass with a razor scraper. Run the scraper down the joint between the glass and frame, then scrape away the paint working toward the sash.

BIRMINGHAM'S FASTEST-SELLING LUXURY CONDOMINIUMS

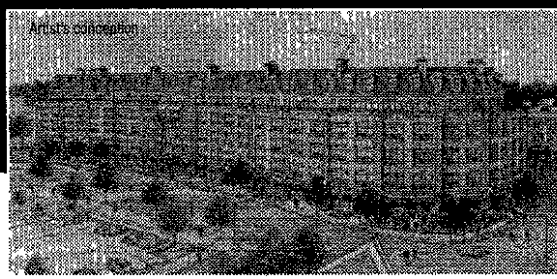

The Willits

Almost 70% Sold—Now Selling Final Phase!

Downtown Birmingham's only full service building is just steps away from shops, restaurants, parks and theatres. Plus, The Willits offers the discriminating buyer the space and ceiling heights to create a sumptuous, custom designed residence. Unparalleled luxury abounds with gourmet kitchens, luxurious master baths and private balconies on select penthouses. Fabulous amenities include elegant lobby, concierge, 24 hour security, health club with Swimex® and heated, secured parking with storage.

Two-level Penthouses
(ranging from 2635 to over 3800 square feet)
Priced from \$1.9 million*

Luxury Condominiums
(ranging from 1788 to over 2900 square feet)
Priced from the low \$700,000's*

Visit our Residential Marketing Center next to Smith & Hawken at 236 West Maple. Open from 10pm - 6pm daily or call (205) 593-0855.

Robertson Brothers **Rb** Community Builders

in partnership with **PALLADIUM** The Palladium Company

www.robertson-brothers.com



*Prices and availability subject to change without notice.

Phase II NOW OPEN

NOVI'S PREMIER CONDOMINIUMS

From The Low 200's



Combining the peaceful, relaxed ambiance of country living with nearby city conveniences, a Meadowbrook Townhome condominium is a very special place to call home. Select from over 17 spacious two-, three-, and four-bedroom floor plans, even a first-floor master suite option. Each home features an attached two car garage, full basement and many luxurious touches and special conveniences.

Come home to Meadowbrook Townhomes!

Call today! **248.349.6900**

Meadowbrook Townhomes

29215 Meadowbrook Road • Novi, Michigan 48377
fax: 248.926.5462

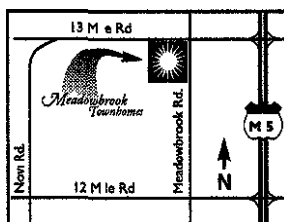

Sales Office Hours
Mon Tues Wed Fri
2pm - 7pm
Sat Sun 1pm - 5pm
Located 1/2 mile east of Novi Road at Thirteen and Meadowbrook

FRAM American EQUAL HOUSING OPPORTUNITY PDF L108084

Welcome Home...

As Little As \$526 per month*



- 1200 sq ft to 2300 sq ft
- 2-5 Bedroom Floorplans
- Country Kitchens
- GE Appliance Packages
- 5 Year Home Warranty
- Custom Decors
- Financing Available

Spec Homes and Model Homes Now Open!
Minutes from I-275, I-96, US 23 and M 14

- Featuring Award-Winning Palm Harbor Homes
- SE Michigan's Exclusive Palm Harbor Retailer
- *Energy Star Award
- National Housing Quality Award 2001

\$99/month rent for one full year through American HomeChoice.

Palm Harbor Homes American HomeChoice 001
DATE _____
PAY TO THE ORDER OF *AHC Customer*** \$ *3100.00*
AMOUNT *Three Thousand One Hundred no/100*
John Gaiduna
American HomeChoice

Model Showcase Now Open!
These American HomeChoice Affiliate Communities Offer the Finest Amenities:

- Beautiful Clubhouse
- Swimming Pool
- Exceptional Landscaping
- Large, Sodded Homesites

American HomeChoice
1-800-742-0704

* Based on \$60,000 home with 10% down, 360 months and approved credit.
** Palm Harbor Homes/American HomeChoice rebate check only available at affiliate AHC communities to apply to lot rent only.

Small apartments ideal for student housing

Student housing is increasing in demand and the Wild Wood (408-30) would be ideal.

It is a four-unit building with each unit containing 923 square feet. The unit is two-story and may require a parking area as none of the units comes with a garage.

There is a large bike storage area, easily placed on either end or placed on both ends with the revision of the plans. The facade of the unit is simple with a picket railing across the face of the second floor.

Each unit contains the same basic floor plan.

They have, however, been mirrored in two of the units, making the dining rooms back-to-back. The front door opens facing the living room in each unit. On two of the units the kitchen is on the right and a half bath and stairway is on the left. The other two units are just opposite.

Past the kitchen is a dining room that blends into the living room. Under the stairs is a storage closet with the water heater tucked away.

The living room has sliding doors that open onto the back yard.

Upstairs are two bedrooms with a bath between. The stairs and the bath are reversed in two of the units to match the downstairs.

Bedroom 1 is the larger of the two bedrooms with a wall closet running the length of the entire wall. The bathroom has a tub and single sink. A linen closet is in the hall. Bedroom 2 has a corner wall closet with a raised built-in cabinet and shelf.

This quad is so simply designed that it would be ideal to be part of an apartment complex. While the apartments are not large, they are ideally sized for students or lower income housing. It should also be economic to build and doesn't require a large amount of lot space.

For a study plan, including scaled floor plans, elevations and an artist rendering, send \$24.95 to Landmark Designs, 33127 Sogunaw Road E., Cottage Grove, OR 97424. Please specify plan name (Wildwood) and the number (408-30).

A catalog featuring hundreds of home plans is available for \$12.95, or save by ordering both for \$29.95. For faster processing, call (800) 562-1151 or visit www.landmarkdesigns.com.

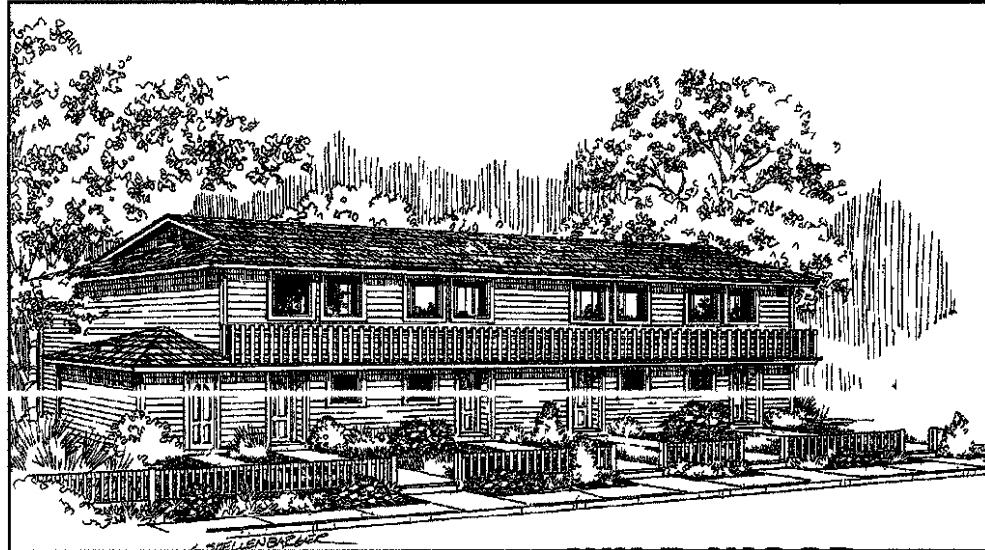

WILD WOOD (408-30)
OVERALL DIMENSIONS 71'-6" X 30'-0"
LIVING 923 square feet/unit

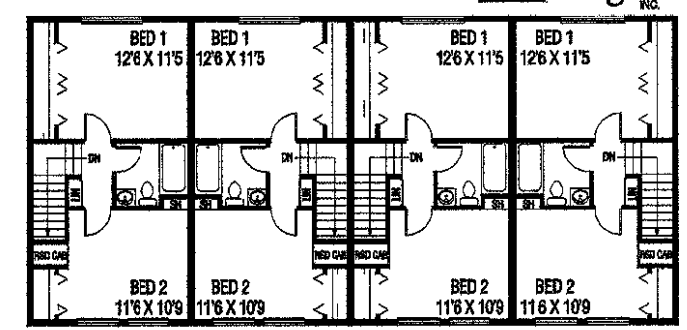

FIRST FLOOR PLAN
480 SQ. FT./UNIT

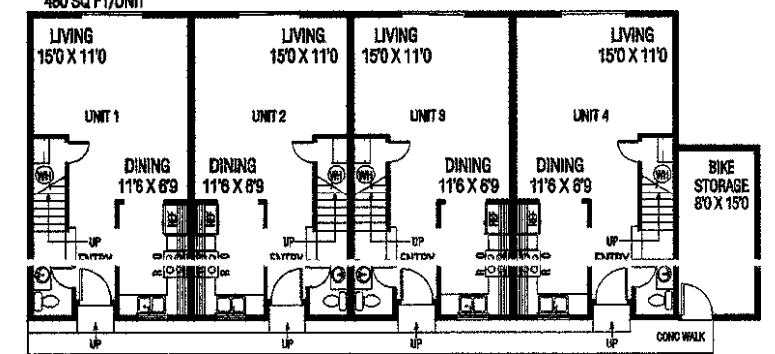

Enjoy spas that come in all shapes and sizes

BY JAMES AND MORRIS CAREY
FOR AP NEWSFEATURES

It has been only about 40 years since hot tubs were nothing more than wooden barrels filled with hot water. Then they got bigger, and were equipped with water jets and air jets. Later they were made of molded plastic instead of wood. When that happened a new industry developed almost overnight.

As spa industry growth continues, the consumer is left with the "how-do-I-choose-the-right-one" question. We can help.

The spa experience is without a doubt enjoyable and therapeutic. According to Jeff Kurth, chairman of the National Spa and Pool Institute (NSPI) and

CEO of Marquis Spas, "A spa provides buoyancy that eliminates 90 percent of the force of gravity on the human body. Heat dilates blood vessels and increases the flow of nutrients to damaged muscle tissue while flushing out toxins that make you feel sore. The hydrotherapy part also helps to massage the toxins out of the muscles."

Kurth further commented, "Depending on the size, number, type and location of the jets, various types of massage can be achieved."

We agree that you really can feel the results. And the stress relief is pronounced.

Why get a fancy spa as opposed to one with fewer or

smaller pumps and fewer jets? The more options, the better your chance of finding comfort and satisfaction for the whole family. Not every jet pattern in every location of a given spa will please everyone. Some will feel only OK, others will work wonders. Someone else in your family might find the greatest comfort in the position you like the least. The more options you have, the better served you and your family will be.

Today spas are available with up to three motors — just to pump water through the jets. Multiple controls and multiple compartments make it possible for one person in the family to have a vigorous massage while

others can enjoy other options.

Possible features

■ An airtight spa cover. A good one reduces energy loss when the spa isn't in use. Our favorite is vinyl-encased foam with a tapered top. Make sure it is an ASTM listed locking safety cover. A locking top will keep energy in and toddlers out.

■ Solid insulation between the spa and the skirt. Fully insulated units are more energy-efficient.

■ A built-in ozonator can reduce the amount of chemicals needed to kill bacteria in the water. If you are allergic to chlorine or bromine, an ozonator can be used in conjunction with sil-

ver, which is a natural bactericide.

■ Two filters are better than one. Units with multiple filters clean faster and better.

■ Measure the horsepower of the pumps, the number of jets, the number of controls and the number of stations. These are key elements to comfort in a spa.

■ Check with your doctor and your insurance carrier. Some insurance companies will cover the cost of a home spa. If you have no insurance coverage, check with your accountant to see if you can deduct all or part of the cost of your spa from your income taxes.

■ Spas, like swimming pools, can be used year-round. But as

we know, swimming pools are best on hot days. This is not necessarily so with spas. We think spas are most fun when it's cold. There is nothing like sitting in a spa on a cool fall or winter early morning looking up at the stars.

The National Spa and Pool Institute helps set safety standards, and Underwriter's Laboratories (UL) tests spas for safety. Only those products approved by UL should be used. Folks with a heart condition or high blood pressure should check with their doctor before using a spa.

For more home improvement tips and information visit our Web site at www.onthehouse.com.

PREMIER MORTGAGE LENDERS

Truth in Lending

www.premierlender.com/detroit

ADVERTISEMENT

Michigan Mortgage Reality Check

Consumer Mortgage Advisory #6: The Good Faith Estimate.

Before you complete that mortgage application and pay the fee, get a "good faith estimate." This discloses your interest rate, term, all costs and fees, amount of cash you will need at closing, and the annual percentage rate. It must be very close to accurate at the time of your application. That's the law.

U.S. Averages

Rates at a Glance

30-yr fixed mortgage	7.02%
15-yr fixed mortgage	6.63%
Adjustable mortgage	6.20%
FHA insured mortgage	7.13%
Fed funds	3.58%

Finance Rates

Prime Rate	6.50%
Discount Rate	3.00%
90-day T-Bill	3.36%
6 mo T-Bill	3.28%
1 yr T-Bill	3.38%
2-yr T-Note	3.61%
10-yr T-Bond	4.79%
30 yr T-Bond	5.37%

SOURCE: THE MEYERS REPORT & FEDERAL RESERVE STATISTICAL RELEASE H.15

ECONOMIC CALENDAR

This week's releases

Sep 6	Bureau of Labor Statistics Unemployment Insurance Weekly Claims Report
Sep 7	Department of Labor The Employment Situation
Sep 7	Department of Agriculture U.S. Export Sales
Sep 7	Department of Commerce Selected Economic Indicators
Sep 10	Federal Reserve Board Selected U.S. Interest Rates
Sep 10	Department of the Treasury 13 & 26 Week Treasury Auction Results

Membership Qualifications

- All lenders must:
1. be a chartered bank, savings association or credit union,
 2. or have been in business for at least five years and have successfully closed 5,000 loans,
 3. must not have hidden fees or excessive fees, as determined by MCG from a survey of participating lenders.

MEYERS ON MORTGAGES

by GARY S. MEYERS

YOUR CREDIT AND BUYING A HOME

Will bad credit two years ago keep you out of the housing market? Does a real estate agent have a right to see your credit application? Today The Meyers Report gets answers to readers questions from the experts.

Q. We are purchasing a home. The seller's real estate agent asked my bank for a copy of the mortgage loan application. Do they have a right to see that? Why would they want to look at it?

A. Usually the seller's agent asks for a pre-approval letter, not the application itself. It's against the law for a lender to disclose debt to a third party without the borrower's approval. Your loan application has information about your debt.

"We, as bankers, know how private this information is," Tom Drozd residential mortgage originator for Archer Bank, said. "If I was the borrower, I would say no and tell them to call my banker. My banker will tell the real estate agent whether or not he thinks the loan will go through."

Q. When I was a college student my credit rating went from good to bad. During the last two years, since I have been out of school, I have tried to keep current with all of my bills, such as telephone, rent and utilities. I want to buy a house in the next two to three years and was wondering if I continued my path of keeping my bills current, will my past credit problems have a big effect when I go looking for a mortgage? The credit card bills I got in school, I haven't paid in five years thus far.

A. You will have to pay off all your outstanding collections, Rick DeLeon, branch manager for Allied Mortgage Capital Corporation, said. Most lenders look for 24 months of a clean history, providing you have no bankruptcies or foreclosures in

your past. That is time enough to re-establish your good credit. If you have cleaned up your bills, you may qualify for an FHA loan. For more details, check out Allied Mortgage's web site www.nolandlord.com.

Q. My wife and I had a bankruptcy that was discharged two and a half years ago. It was only on credit card debt. We reaffirmed our house and two car loans. We want to start looking at a new house, but are unsure how this will affect getting a new mortgage.

A. "The bankruptcy does not prevent you from getting a new mortgage," Jeff Bock, retail manager for North American Mortgage, said. "Your rate and loan to value will fluctuate depending on how the rest of your credit report looks." Lenders will be looking for stability — how you have repaid other creditors, your earnings, and if your mortgage has been paid on time.

Most lenders will not process a loan less than two years after a Chapter 7 bankruptcy is discharged. A few will take an application as little as one day later, but require the borrower have at least 20 percent down. If someone has filed for a Chapter 13 bankruptcy, the borrower will be required to pay off his/her debts out of the loan first.

Q. My husband and I are trying to get a mortgage to buy a new home in the Plainfield, IL area. We already own a home and plan on selling it. The money we make from the sale will be used toward a down payment on a new home. We have had credit problems — been late on our mortgage and car payment, but not all the time. My husband has been at his job for 23 years and earned \$74,000 last year. I have been at my job for four years and earned

\$10,000 last year. We know we can afford a house, but our credit problems are holding us back.

A. There is some good news for you, said Michael Niecestro, sales manager at Midwest Funding and a 20 year veteran of the mortgage business. Your job stability and the location in which you are house hunting are on your side. Plainfield is an "FHA Municipality." If you are planning to borrow at least \$209,000 you may qualify for an FHA new construction mortgage.

"FHA is more liberal when it comes to underwriting guidelines and doesn't look at credit scores," Niecestro said.

Instead it puts more emphasis on whether the buyer is current on credit debt, ability to pay back the mortgage, and the down payment.

You already know that your late payments can be a problem for other conventional loans. When lenders run a credit report they look for a credit score of at least 620, Niecestro said. The score will take into account such things as the amount of open credit, as well as past judgments, bankruptcies, and collections. You said you were sometimes late on your mortgage payments. Lenders do not like to see 30 to 60 day late payments unless the borrower has had a clean history for the last 12 months. Credit scores do fluctuate month to month. Therefore, if for some reason you have a lower score, you can raise it fairly quickly by bringing credit balances down and keeping payments current.

Gary S. Meyers is President and CEO of Meyers Communications Group Inc. and Founder of The Meyers Report. He is a Nationally Syndicated Columnist and Economist. Mr. Meyers can be reached at gmeyers@meysersnetwork.com (c) 2001 Meyers Communications Group Inc. 847 205 9222

Michigan Averages

This week Program	Avg Rate*	Avg APR*	Disc pts.	Ong fee	Mo pmt.	Income required
30-Yr. fixed	7.00%	7.14%	0%	0%	\$665	\$26,612
15-Yr. fixed	6.31%	6.49%	0%	0%	\$860	\$34,433
5/1-Yr. ARM	6.38%	6.59%	0%	0%	\$623	\$24,954

SOURCE: The Meyers Report 1 847 205 9222

PDF1087088

Attention Readers
Place a Garage Sale Ad and be eligible to win a \$50 gift card from Meijer, Inc.
MEIJER
One winner per week! Winner's name will be published every Thursday in this section

DATA ENTRY
Production Operators
Experienced Accurate Fast
Must be steady, dependable...
We received 40 to 50 resumes on this ad and are very happy with the wonderful response!
W.V. Dearborn
HOME TOWN CLASSIFIEDS WORK!

Observer & Eccentric

CLASSIFIEDS

It's all about RESULTS!

Part of The HomeTown Communications Network™
www.observer-eccentric.com

IT'S EASY TO FIND IT BUY IT SELL IT IN THE CLASSIFIEDS



IT'S EASY TO PLACE YOUR CLASSIFIED AD JUST CALL, FAX or E-MAIL



OAKLAND COUNTY 248-644-1070
WAYNE COUNTY 734-591-0900
ROCHESTER AREA 248-852-3222
CLARKSTON WATERFORD 248-475-4596
TOLL FREE 800-579-SELL
FAX YOUR AD 734-953-2232

24 HOUR VOICE MAIL and E-MAIL
BOOKMARK OUR WEBSITE
www.observer-eccentric.com

DEADLINES:

For Placing, Canceling or Correcting of Liner Ads.

Publication Day	Deadline
SUNDAY REAL ESTATE	5:00 P.M. THURSDAY
SUNDAY ISSUE	5:00 P.M. FRIDAY
THURSDAY	5:30 P.M. TUESDAY

Walk-In Office Hours:

Monday - Friday 8:30 am - 5:00 pm

OBSERVER SALES OFFICE
36251 Schoolcraft, Livonia, MI 48150

ECCENTRIC SALES OFFICE
805 East Maple, Birmingham, MI 48009

Policy

All advertising published in The Observer & Eccentric is subject to the conditions stated in the applicable rate card copies of which are available from the Advertising Department. Observer & Eccentric Newspapers 36251 Schoolcraft Road, Livonia, MI 48150 (734) 591-2300. The Observer & Eccentric reserves the right not to accept an advertiser's order. Observer & Eccentric Ad Takers have no authority to bind this newspaper and only publication of an advertisement shall constitute final acceptance of the advertiser's order.

Please Check Your Ad

The Observer & Eccentric will issue credit for typographical or other errors only on the first insertion of an advertisement. If an error occurs, the advertiser must notify the Customer Service Department in time to correct the error before the second insertion.

Home & Service Guide #001-245	Real Estate For Sale #300-389	Commercial Industrial Sale or Lease #389-398	Real Estate For Rent #400-498	HELP WANTED Employment/Institution Services #500-598
Announcements #600-698	Merchandise #700-778	Garage Sale Moving Sale #711-713	Animals Pets/Livestock #780-798	Automotive Recreational Vehicles #800-899

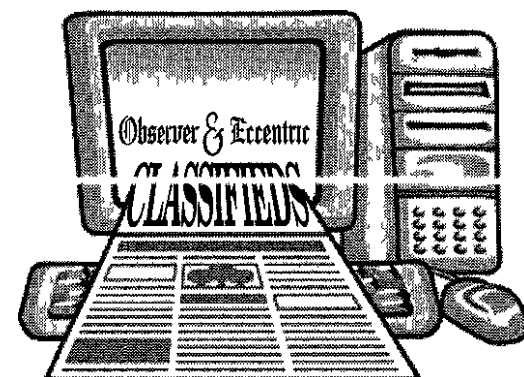

All Our Ads Are Online!
You can place your ad 24/7
Sure to be a Favorite Site



Helpful Hints:

For the best results when writing your classified ad put yourself in the readers/buyers shoes. Describe the items for sale or job opening by including details that would attract your friends. Avoid abbreviations. Include a phone number and best times to call. Include price/salary range and benefits. Include an e-mail address if possible because

your ad also appears on our internet site. Use key wording for easy searching and reading. List age, brand, style and condition of items. Don't be afraid to ask our friendly, professional staff for help. Remember you want results so the more you tell and the more people your ad reaches the more responses you will receive. **Call us today, we can help you!**

RUN IT UNTIL IT SELLS!

1-800-579-SELL

Give your Observer & Eccentric Classifieds a call today and we'll tell you how to "Run it Until it Sells!"

Applies only to all transportation classifications.

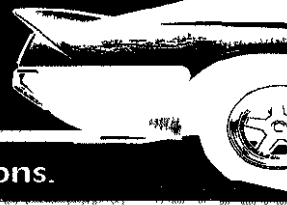
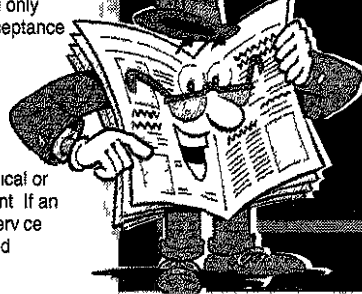

300's Real Estate

303 Open Houses	344 West Bloomfield/Orchard Lake/Keego Harbor
304 Ann Arbor	345 Westland/Wayne
305 Birmingham/Bloomfield	348 Wyom/Walled Lake/Commerce
306 Brighton	349 Ypsilant/Belle Isle
308 Canton	352 Livingston County
309 Clarkston	353 Macomb County
311 Dearborn/Dearborn Hgts	354 Oakland County
312 Detroit	356 Washtenaw County
314 Farmington/Farmington Hills	357 Wayne County
317 Garden City	358 Lakefront/Waterfront Homes
318 Grosse Pointe	359 Other Suburban Homes
319 Hamburg	360 Out of State Homes/Property
320 Hartland	361 Country Homes
321 Highland	363 Farms/Horse Farms
322 Holly/Fenton	364 Real Estate Services
323 Howell	370 New Home Builders
325 Livonia	371 Apartments For Sale
326 Midford	372 Condos
327 New Hudson	373 Duplexes & Townhouses
328 Northville	374 Manufactured Homes
329 Novi	375 Mobil Homes
331 Onon Township/Lake Onon/Oxford	376 Homes Under Construction
333 Piquette	377 Lakefront Property
334 Plymouth	378 Lake/River Resort/Property
335 Redford	379 Northern Property
336 Rochester/Auburn Hills	381 Southern Property
337 Royal Oak/Oak Park/Huntington Woods	382 Lots & Acreage/Vacant
338 Salem/Salem Township	383 Time Share
339 Southfield/Lathrup	384 Lease/Option To Buy
340 South Lyon	385 Mortgage/Land Contracts
341 Troy	386 Money To Loan
342 Waterford/Union Lake/White Lake	386 Money To Borrow
	387 Real Estate Wanted
	388 Cemetery Lots

303 Open Houses

ANN ARBOR Schools Open Sun 2-5 4918 Hickory Pointe Blvd 3 bedroom 2 1/2 bath 2157sqft New in 2000 Cape Cod with large walk out basement overlooking park. Cattedrinal ceilings hardwood floors premium upgrades Immediate occupancy \$274,900 734 340 3308 734 657 8661

3 bedroom 2 bath 1.5 car garage new roof & windows \$119,500 20510 Olympia 8 Mile & Beech 313 541 0988

BELLEVILLE Open Sun Sept 9 1-4pm 15205 Haggerty Rd 5 bedroom farm house \$279,900 Angela Nattro & Co Real Estate Nancy Stoddart (734) 267 3625

BERKLEY 4113 Thomas Open Sun 9-9 10.4 Charming value packed 3 bed 1.5 bath bungalow Newer furnace C/A windows roof Beautiful hardwood floors freshly painted kitchen w/new lighting & vinyl floor large master w/newly built closet Professionally finished basement w/glass block windows & built in bar Wood porch in front 3 season porch in rear beautiful new patio & landscaping fenced in backyard 1 car garage w/opener all appliances included \$174,900 Call for appt 248-435 5993

BEVERLY HILLS Birmingham schools Open Sunday 1-4 15690 Kirkshire 14 Mile and Greenfield 3 bedroom ranch updated kitchen new addition (dining room) updated bath fireplace hardwood floors partial basement 1st floor laundry move in cond \$209,000 (248) 647 2933

BEVERLY HILLS 3 bedroom 2000 sq ft brick ranch w/1 car garage w/opener all appliances included Open Sun 2-5 21880 Hampton 3 blocks N of 13 Mile E of Lahser \$349,900 248 646 1018

303 Open Houses

Beverly Hills OPEN SUNDAY 1-4 JUST LISTED! Totally updated Ranch! Open floor plan hardwood floors French doors to deck & nicely landscaped fenced yard 1.5 car garage Quiet street \$168,900 Call Bernadette 248 875 6020 Real Estate One...

OPEN SUN 2-4 BLOOMFIELD 'THE HEATHERS' Desirable lower unit overlooking the 2nd fairway Light bright open move in condition 1 car garage \$244,900 1961 Eagle Pointe N/Square lake Rd E/Copyke Real Estate One 248-644-4700 Kathleen Robinson (248)561 1210

BRIGHTON Open Sun Sept 9 1-4pm Ultimate wooded paradise w/der 1.17 acre 2457sqft 2 story 3 car garage Total privacy front & back \$394,900 Buyer Agents OK 810-494 8999

BRIGHTON OPEN SUN 12-4 6378 Oakdale 2150 sq ft Fondia Lake access 1st floor Hardwood floors \$169,000 (810) 225 0038

Brighton OPEN SUNDAY 2-4 4651 Brookwood Meadows Price reduced on this gorgeous 4 bedroom 3 1/2 bath home on 1.94 acres Complete 2 bed room in law apartment in walk out lower level \$389,900 All offers will be seriously considered Maryanna Teleso 734-645 3065 or 734-741 4149 Edward Surovel Realtors

OPEN SUNDAY Sept. 9 2:00-4:00

10256 Sarah Jean Pickney M 36 South on Howell West on Mower 3499 sq ft 4 bedroom 3 1/2 bath ultimate luxury on 10 pristine wooded rolling private acres \$439,000 (212)933 Kathy Toth 734-669-0337 team@aaarealtor.com REMAX Community Assoc 2699 Oak Valley Dr. Ann Arbor Each Office Independently Owned and Operated

TROY RARE OPPORTUNITY

Well established small business & custom built home on almost 2 acres Strong income Dog & cat boarding with grooming salon Home is approx 4000 sq ft and includes nanny in law apt 4 bedrooms 1 1/2 baths full basement granite pool plus more Serious Inquiries Only \$850,000 Will pay realtor's selling commission! 248-879-0420

Classifieds Work!

Help-U-Sell REAL ESTATE
(734) 454-9535

Sellers Save Thousands In Commissions & Keep The Equity You've Earned!

- Canton/Plymouth
- Livonia
- Westland
- Wayne
- Garden City
- Farmington Hills
- Dearborn Heights
- Dearborn
- Redford
- Belleville

Open Houses

Open Sun 1-4 3392 Creeks Bend, Canton Built in 1999 large colonial with huge yard family room Finished basement \$244,900
Open Sun 1-4 35249 Winslow Wayne Gorgeous country colonial corner lot oak kitchen FR w/fireplace 3 season room \$164,900
Open Sun 1-4 33976 Currier Wayne 3 bedroom bungalow large master bedroom 1.5 baths Part finished basement Asking \$94,900
Open Sun 1-4 11107 Van Buren Belleville 3 bedroom ranch 2.5 car garage all appliances stp updated bath roof doors & more \$129,900
Open Sun 1-4 45452 Holmes Canton Sunflower ranch with 2.5 baths garage basement Great Rm w/fireplace 1800 sq ft \$239,900

Other Available Homes

42567 Lilley Pointe Canton 2 bedroom Condo with 2 full baths white kitchen Master bdrm w/bath Great condition \$127,900
41776 Wild Turkey Ct Canton 1998 built 2 bedroom Condo 2.5 baths master suite 1st floor laundry Asking \$199,900
23325 Mystic Forest Novi Newer built 4 bdrm colonial backs to breath taking nature preserve many amenities \$389,900
2541 Rhead Circle Westland 1300+ sq ft ranch with open floor plan full basement vaulted ceiling fireplace garage \$174,900
5010 Williams Wayne Almost 1400 sq ft 3 bedroom Brick Ranch Family Rm & LR 2 car garage Asking \$137,900
12615 Mercedes Redford Updated 3 bedroom Ranch 1.2 acre lot Investment property or starter home Asking \$92,900
7744 Appoline, Dearborn 1700 sq ft, 2 1/2 story 3 bedrooms finished basement 2nd story porch 2 car garage \$194,900
46489 Killarney Circle Canton 2 possible 3 bdrm ranch in the Links open concept beautiful decor 2 car garage \$264,900
5029 Palmer Dearborn 3 bedroom 2 1/2 car garage bungalow style home basement well updated \$124,900
11783 Grayfield Redford 3 Bedroom ranch 2 car garage, finished basement Needs a little work \$125,000
8886 Floral, Livonia Newer construction 1996 country colonial 3 BR 2.5 baths basement & garage \$198,900
6735 Schaller, Garden City 3 bedroom brick ranch, new windows plumbing & paint Full basement Imm poss \$142,900
35274 Wallace, Westland Excellent starter 2 possibly 3 bedroom ranch Full basement garage new windows \$104,900
24778 Donald, Redford 3 bedroom brick ranch Large lot finished basement w possible 4th BR 1.5 baths \$144,900
31547 Rush St, Garden City 3 bedroom 1450 sq ft walkout basement updated bath, 2 car garage \$144,900
7729 Capri, Canton 3 bedroom ranch 2.5 baths 1700 sq ft 2 car garage basement family rm w/fpl \$232,900
1517 Berkshire Westland 3 bdrm ranch fireplace in living room. Just move on in 2 car garage. Backs to park \$119,900
2305 Treadwell Westland 3 bedroom brick ranch 2 car attached garage Family Rm w/fireplace 1.5 baths \$152,900
17133 Brady Redford Sharp 3 bed oem ranch newer roof windows furnace & more Basement & garage \$104,900
2115 Ellsworth Westland Updated 3 bedroom ranch, newer AC & furnace & more gorgeous oak kitchen, 2.5 car attached garage \$89,900

Gentry Real Estate, Inc. (248) 887-7500

2550 E. Highland Rd., Highland



CHARMING HOME
3 bedroom home in the heart of South Lyon New kitchen with new appliances Beautiful hardwood floors Fresh paint Walk to town shops and school Motivated seller Price reduced to \$168,500 (R 092)



ALL SPORTS WALLED LAKE WATERFRONT
Updated and adorable describes this 2 bed room 1 bath ranch home New central air 13 x6 mud room with pantry and closet fenced yard and secluded deck to add to your comfort Enjoy the water and sunsets from your umbrella table on large platform at end of new dock \$204,900 (R 090)



ENJOY LAKE PRIVILEGES
Privileges on beautiful Mandon Lake complete the package of this deal! This immaculate updated 3 bedroom ranch features an open floor plan with neutral decor A privacy fence surrounds large yard w/mature trees Owner will entertain all offers \$129,800 (R 012)



HOME ON ACREAGE
Over 10 fabulous acres of huge hardwoods and rolling hills is the setting for this 1300 sq ft 3 BR ranch w/full walkout basement Two barns to satisfy any need are 20 x30 w/2 stalls and 30 x40 Don't miss out call now on this hard to find commodity! \$224,900 (R 094)

Policy

All advertising published in The Observer & Eccentric is subject to the conditions stated in the applicable rate card copies of which are available from the Advertising Department. Observer & Eccentric Newspapers 36251 Schoolcraft Road, Livonia, MI 48150 (734) 591-2300. The Observer & Eccentric reserves the right not to accept an advertiser's order. Observer & Eccentric Ad Takers have no authority to bind this newspaper and only publication of an advertisement shall constitute final acceptance of the advertiser's order.

Please Check Your Ad

The Observer & Eccentric will issue credit for typographical or other errors only on the first insertion of an advertisement. If an error occurs, the advertiser must notify the Customer Service Department in time to correct the error before the second insertion.



RealEstateOne.com 734-455-7000



We open doors for you!

Table of real estate listings with columns for location (e.g., Belleville, Redford, Plymouth), property details, and contact information.

See you next month!

e-mail - plymouth@realestateone.com

Grid of 303 Open Houses listings, including details for Canton, Farmington Hills, and Livonia properties.



Real Estate One Does It Again!! The #1 Virtual Tour Provider in Michigan More Tours...Of More Homes...Than Anyone Else



THE REAL ESTATE ONE FAMILY OF COMPANIES: REAL ESTATE ONE • RALPH MANUEL ASSOCIATES • JOHNSTONE & JOHNSTONE

Large grid of real estate listings with photos, descriptions, and contact info for various properties in Detroit, Livonia, Farmington Hills, and Northville.

LIVONIA OFFICE • (734) 591-9200 • 38705 SEVEN MILE RD., STE 150



Thomas Ervin
Let's Talk About Real Estate

"BUYER'S REMORSE"

There is a rather common phenomenon known as buyer's remorse. Often occurring after the purchase of a big ticket item, it involves a feeling of panic that perhaps you acted too quickly in making a recent purchase and paid too much for the item.

This feeling is often related to the purchase of a car or home. After the euphoria of a purchase wears off, panic begins to set in. In the purchase of real estate, it usually happens about three days after signing the agreement of sale. Here are some factors that cause buyer's remorse.

You had to Compete With Another Buyer For The House

If you are in competition with another buyer, you may get emotionally involved in the competition only to question your buying decision after the battle is decided in your favor. You may wonder why the other buyer was willing to give up in the bidding. The thing to remember is that the property meets your needs and is the right buying decision for you.

A Trusted Friend Or Relative Questions the Purchase

It is not unusual for a buyer to take a trusted friend or relative for a ride by the house shortly after negotiating its purchase. If this person tells you that he or she would not have bought this house or would not have paid the price you paid, you could begin to have serious doubts. The important point to remember is this situation is that real estate is a very personal choice. If it appeals to you, that is all that counts. Also, your friend or relative may or may not be as aware of current real estate prices as you are.

ADVICE: Don't allow buyer's remorse to get the best of you. It happens to most people in varying degrees after a major purchase.

Visit Tom's website at www.tomervin.com

PUBLISHER'S NOTICE

All real estate advertising in this newspaper is subject to the Fair Housing Act which makes it illegal to advertise any preference, limitation or discrimination based on race, color, religion, sex, handicap, familial status or national origin or an intention to make any such preference, limitation or discrimination. Familial status includes children under the age of 18 living with parents or legal custodians, pregnant women and people securing custody of children under 18.

This newspaper will not knowingly accept any advertising for real estate which is in violation of the law. Our readers are hereby informed that all dwellings advertised in this newspaper are available on an equal opportunity basis. To complain of discrimination call HUD toll free at 1 800 689 9777. The toll free telephone number for the hearing impaired is 1 800 368 9719.



303 Open Houses

LIVONIA OPEN SUN 12-2

17961 Floral (N. of W. Inkster) Brick ranch on 1/2 acre lot. Updates galore! 2 1/2 car garage, newer roof, garage door, furnace, C/A. Clean neutral decor and newer carpet throughout. Perfect to retire or first time buyers! Offered at only \$154,900.

DEBORAH DeLaROSA
RE/MERICA HOMETOWN III
(734) 459 9898 ext 264
deborah@deborahsells.com

LIVONIA OPEN SUN 1-4

14243 Newburgh W/Newburgh S/Schoolcraft. Sprawling 3 bed room 2 1/2 bath ranch w/almost 1800 square feet on half acre landscaped lot w/wrap around cedar deck. Updates throughout. Family room w/fireplace. 2 Car attached garage. Call Joe Consiglio Century 21 Hartwood South Inc. 313-660 3525

LIVONIA RANCH completely updated. Super clean and nice. Open house Sunday Sept 09 1pm-5pm 31647 Perth (248) 305 9242

303 Open Houses

Milford OPEN HOUSE TODAY

Noon to 5pm
New Home with Private Lake Frontage in Milford!
IMMEDIATE OCCUPANCY

This 4 bedroom 2 1/2 bath estate home site on a one acre site with private Stonebridge Lake frontage. Home features 9 first floor ceilings, conservatory addition, master bedroom suite w/private bath and roman tub, family room w/woodburning fireplace, central air, hardwood floors and full walk-out lower level with 9 walls and rough plumbing prep for bath. Home located in a spectacular lake community with beach, picnic and park areas and walking trails.

Exceptionally priced at \$498,975

For more information & directions please call 248 684 2111

NORTHVILLE HILLS GOLF CLUB

INVESTOR

Resort-Class Lifestyle!

OPEN SUN 1-4

Don't miss your chance at this stunning 3800 sq ft colonial home with 4 bed rooms & 3 1/2 baths in Northville's prestigious new Northville Hills Golf Club community. This home features beautiful brick exterior with signature millwork throughout, 9 first and second floor ceilings, gourmet island kitchen with appliances and granite countertops, included master suite with private walk in closet, 3 car side entry attached garage, first floor laundry and much more! **HOMEOWNER WILL ENJOY ONE YEAR GOLF PASS** plus access to the clubhouse, swim & fitness center, tennis and Northville schools. Minutes from downtown Northville. Please come by 45443 Tournament Drive for your tour. Asking \$689,975. Valerie at (734) 254 9100

NORTHVILLE OPEN SUN 9/9

1:10-4pm 4 bedroom, 2 1/2 bath, 2800sq ft. pillar colonnet on quiet cul de sac, totally private wooded yard w/irround pool, finished basement, 20659 Lexington Ct 1 block S of 8 Mile W of Taft \$378,000 (248) 349 5244

303 Open Houses

Northville GORGEOUS HOME ON PREMIER GOLF COURSE

IN NORTHVILLE
One Yr Golf Membership included!!!
Immediate Occupancy

Open Sunday, Sept. 9, 1-4

Spectacular views await you from this stunning 4 bedroom 3 1/2 bath home in Northville. This home features beautiful brick exterior with signature millwork throughout, 9 first floor ceilings, two-story living room with floor to ceiling windows overlooking an ARNOLD PALMER SIGNATURE GOLF COURSE gourmet kitchen with granite countertops and island, cooktop, separate family room with vaulted ceiling and a first floor master suite with private bath and individual closets. Second story features dramatic balcony overlook & 3 secondary bedrooms, complete landscaping and a ONE YEAR GOLF MEMBERSHIP INCLUDED. This fairway home is part of the Golf Club community in prestigious Northville minutes from I-96 and M 14. Please come by 15332 Bay Hill Drive for your tour. Asking \$514,975. MARC or TERESA at 734-667 6600

Northville OPEN SUNDAY 12-4

Edenderry 17482 Stonebrook TOM GRIFFITH Coldwell Banker Preferred (734)416-1241

NOVI OPEN SUN 1-5

Custom Built 3 bedroom 2 1/2 bath ranch 1st floor laundry basement oversized 2 car garage 40906 Villagewood N of 9 Mile & E of Meadowbrook Ask For Ralph 248 314-1455

OPEN SUNDAY 1-3PM

Dramatic 3 story 5 bedroom 3 1/2 bath home in Plymouth's prestigious Walnut Creek. Stately residence with the finest amenities. Many recent updates! \$499,900
NANCY PETRUCELLI
COLDWELL BANKER
SCHWEITZER BAKE
For more info & directions call Shelley at 734-797 1497

REDFORD Open Sun 1-4

17719 Indian 3 bedroom broad front bungalow Realtors welcome. Paving 3 1/2. Very motivated (313) 794-2350

CROSSWORD PUZZLER

ACROSS

- 1 An — and a leg
- 4 Prevent
- 9 Dept of Justice branch
- 12 Roman three
- 13 Stop
- 14 Ancient bird
- 15 — and shakers
- 17 Papeete's locale
- 19 Man's nickname
- 21 Artificial language
- 22 Persistence of Memory painter
- 25 Tel Aviv locale, for short
- 27 Philbin co-ho
- 31 Guido's high note
- 32 " — — Sue"
- 34 Smallest St.

DOWN

- 1 Direct at
- 2 River (Sp)
- 3 Roman 1004
- 4 Land measure
- 5 Lobby
- 6 Apele (abbr)
- 7 Q-U linkup
- 8 Word with jerk or sheet
- 9 Part of TGIF
- 10 Plant life

Answer to Previous Puzzle

DIN AFTER OMA
ETO MIAMI RAE
CAVIAIR SOCCER
CHEF TO
HERE ALB MAIL
EST PLAUSIBLE
AT ARA REC OD
DEODORANT AVG
SELL MIS FREE
IS LIMA
JABBAR DETOUR
ONO FEVER PRO
TOY ELISE TIC

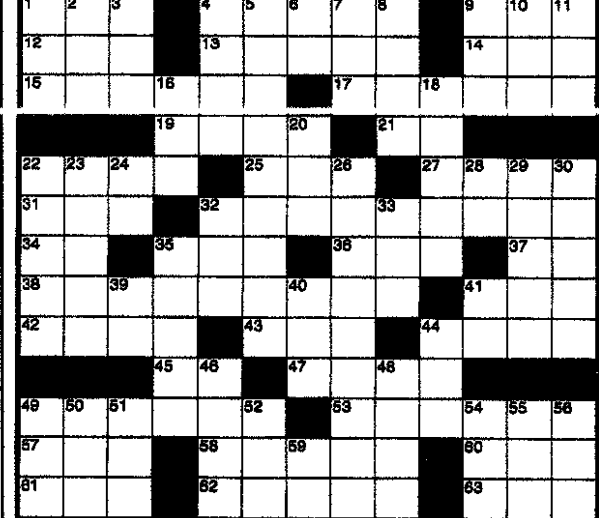

REALTOR Compliments of the BBRSOAR

Birmingham • Bloomfield • Rochester • South Oakland • Association of REALTORS

STUMPED? Call for Answers • Touch-tone or Rotary phones 95¢ per minute • 1-900-454-3535 ext code 708

Classifieds Work!

CENTEX HOMES INTRODUCES

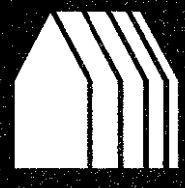

CTX MORTGAGE

WITH **4.97%*** APR FINANCING

THE SELECTIVE GROUP
Builders of Fine Homes & Communities
A Division of CENTEX HOMES

GREAT LOCATIONS... GREAT HOMES... GREAT RATES!*

CANTON

Vistas II
OF CENTRAL PARK
Condominium Homes

from the **\$250's**

(734) 340-3700
West side of Beck, 1/2 mile South of Cherry Hill

THE VISTAS OF
Central Park
Condominium Homes

from the **\$270's**

(734) 340-2097
West side of Beck, 1/2 mile South of Cherry Hill

Cobblestone Ridge
SOUTH
Single Family Homes

from the **\$300's**

(734) 981-9580
Sales Office off Ford Rd between Beck & Canton Center Rd

The Woods
OF CENTRAL PARK
Single Family Homes

from the **\$400's**

(734) 667-4000
On Denton South of Cherry Hill Model Open During Construction

*Buyers must qualify and use CTX mortgage. Offer available for a limited time only. Offer available on select homes only. Offer available in select communities only.

*Note: rate and annual percentage rate based on \$200,000 loan with 10% payment with a 30 year amortization. 4.785% note rate with 4.97% APR for first year, 5.785% note rate with 6.0% APR for second year, 6.785% note rate with 7.01% APR for the third year. Rate is fixed at 6.785% for the remaining term of contract.

FARMINGTON HILLS

Hickory Oaks
Single Family Homes

from the **\$500's**

(248) 626-0770
Model on Maple between Orchard Lake and Farmington Rd

HARTLAND

Autumn Woods
Single Family Homes

from the **\$200's**

(810) 632-2095
Located on Highland Rd (M59) West of US 23

HOWELL

Hampton Ridge
Condominium Homes

from the **\$120's**

(517) 540-1099
Located off Latson Rd North of Grand River (Use Exit 141 off of 96 West)

The Landings
OF ROLLING RIDGE
Condominium Homes

from the **\$170's**

(517) 552-4000
On the North side of Grand River just West of Latson Rd (Use Exit 141 off of 96 West)

Rolling Ridge
Single Family Homes

from the **\$180's**

(517) 545-9047
Located off Latson Rd North of Grand River (Use Exit 141 off of 96 West)

SOUTH LYON

Tanglewood
HOMES OF GRENELEFE
Single Family Homes

from the low **\$300's**

(248) 486-1900
Located on 10 Mile Rd 3 1/2 miles West of Beck

Tanglewood
CONDOS OF GRENELEFE
Condominium Homes

from the **\$300's**

(248) 486-1900
Located on 10 Mile Rd 3 1/2 miles West of Beck

SUPERIOR TOWNSHIP

Brookside
Single Family Homes

from the **\$170's**

(734) 480-3300
On South side of Goddess between Prospect & Harris

WARREN

Heritage Pointe
Single Family Homes

from the **\$160's**

(810) 427-6379
Off 10 Mile Rd., West of Schoenherr Rd

WEST BLOOMFIELD

Maple Creek
Single Family Homes

from the **\$600's**

(248) 626-0770
On Maple between Orchard Lk & Farmington Rd

Equal Housing Opportunity Open Daily 12-6 • Brokers Always Welcome

Home improvement 101: Get details in writing

BY HOME SERVICE STORE
FOR AP WEEKLY FEATURES

Before the euphoria of a home building job dissolves into a "we said-you said" spat between homeowner and contractor, a home repair expert suggests both sides can minimize miscommunication with a series of simple steps, including a clearly written contract.

"Usually somewhere between what was said and what was heard lies the breakdown in communication," said Jeff Polakiewicz of the Home Service Store. "What it should tell homeowners is that everything should be in writing. It's really the only way to do business."

In Polakiewicz's view, better contractors will initiate a contract conversation with homeowners, followed by ample give-and-take before agreeing to a mutually acceptable contract.

■ 'Usually somewhere between what was said and what was heard lies the breakdown in communication.'

*Jeff Polakiewicz
Home Service Store*

While Polakiewicz doesn't routinely see intentional contractor miscommunication in his role as a home repair project manager for the Home Service Store, he does see instances where contractor language is sometimes "over the head" of homeowners.

Often, the contractors assume that homeowners understand what they say, but homeowners are too embarrassed to ask what the terms, definitions and acronyms mean.

"I tell people to speak up when

they are unclear about anything," Polakiewicz said.

He suggests homeowners let the written contract do the talking. Payment terms, inspections, and estimated start and finish dates should be in writing. Items relating to schedules are frequent sore points. "In my experience, the homeowner is most disappointed when the job isn't done on time," said Polakiewicz. "They may rave about the job, but they'll say, 'Yeah, but it took too long.'"

Standard fill-in-the-blank contracts available at most office supply stores can give homeowners an idea about contract structure. Contractors may be required to have contracts on hand that can be tailored to fit the job.

Yet homeowners fail to head off a major source of miscommunication — and irritation with the quality of work — by not

checking contractor references. "It's the biggest mistake homeowners make. People should check references, but most of the time they don't," said Polakiewicz. "What I tell people is to check the contractor's last three jobs."

"Get the addresses and go see their work. You don't want to see what he did three years ago, but what he did the last three weeks," he said.

Polakiewicz said homeowners who have had work done by a contractor are usually glad to share information about contractor performance. If the homeowner had a good experience, they "go above and beyond to say good things." But when their answers are short and clipped, it's a sure sign the job didn't go well.

Contractors can take additional steps to improve communication.

"A contractor who is honest will tell the customer, 'This is what I thought I heard you say' right from the start," said Polakiewicz.

He points to kitchen makeovers as an example.

"Many times customers say, 'I want this and this and this,' but they don't know all the minutia it takes to finish the kitchen. I literally ask them how they cook, how they entertain and what they eat," said Polakiewicz. "It helps people identify how the kitchen should really work because blueprints don't always tell the whole story."

The interpretation of homeowner needs is critical to a job done right and on time. "The toughest thing for the contractor is identifying exactly what the customer wants," said Polakiewicz. "The homeowner is excited once the contractor's truck is in the driveway and

they have grandiose visions, and if their expectations aren't met, things can go sour in a hurry." Computer renditions or elevation drawings can aid homeowner understanding of how the finished job should appear.

Sometimes communication can be too positive, said Polakiewicz.

"Anytime a contractor says 'yes, yes' to your questions just to get the job, they aren't as forthcoming as they can be," he said. "Homeowners need someone to challenge their thinking so they can get the results that match their expectations."

The Home Service Store manages home maintenance, repair and improvement tasks in more than 130 markets nationwide and can be found at www.TrustHSS.com

Kitchen reflects style as well as a place to cook

BY CAROL MCGARVEY
BETTER HOMES AND GARDENS BOOKS
FOR AP WEEKLY FEATURES

The kitchen has form as well as function.

If you are building a new home or remodeling an existing room, you can take advantage of myriad choices in cabinets, appliances, countertops and flooring choices. If you are freshening up an existing space and working around fixtures you may or may not have cho-

sen, there are many opportunities for new looks, too.

What is your style? A new book, "Better Homes and Gardens Kitchen Decorating Ideas & Projects" (Meredith Books, \$14.95 soft cover), will help define your look.

For example, if you favor American or French Country, butter yellow paint, French blue cafe curtains, and cane chairs or stools will help give a South-of-France look.

Paint can be your key to offering a background palette to set the scene. Perhaps a vibrant kitchen color will give a playful look. Or enliven a neutral color repeated from the dining room with a dramatic accent.

Storage is a key element in kitchen design, and open and closed are the defining choices. If new cabinets are in your plan, consider a combination of dark and light wood finishes, or of painted and stained. It's OK to mix glass-door cabinets with open shelving. These days, rules of the past are to be broken.

For extra storage, hang a plate rack to give more cabinet space. Purchase a cart on casters with open shelving for storing often-used pieces.

These tips might help make

the most of available kitchen space.

■ If there's room, bring in a case piece, such as a formal secretary for a convenient desk area.

■ To maximize space in a small kitchen, choose white paint, distressed finishes or light wood, such as maple, to keep a small area as open as possible. Minimize countertop accessories to avoid visual clutter. Leave windows uncovered, if possible.

■ Built-ins sized to specific needs, such as space for a portable television or microwave oven, are a must in a compact kitchen.

■ For simple freshening up, paint the walls or cabinets for an instant update.

■ For new countertops and flooring, common choices are

laminated, solid-surface material, tile and granite. To stretch your budget, combine two different materials. For example, granite is durable, but granite tile is lower in cost.

■ Energize a plain tile backsplash and counter with decorative tiles and insets.

■ Rule of thumb: Darker wood surfaces make a room look cozier, and white and light surfaces make the space seem larger.

■ For a clean, unified look, pair commercial-quality stainless steel countertops with stainless steel appliances. Visual warmth can be added with accessories such as pot-

tery and textured baskets.

■ When the family and friends want to gather 'round the kitchen, lack of seating might be a problem. Here are some alternatives: An L-shaped banquette, a lunch counter, area with small chair seating, a tiny bistro table and chairs, and pull-up stools around a center work island.

Light reveals flaws

A table lamp sitting next to a wall shines critical light on the nearby surface and it will show even the smallest imperfections. Lumps, bumps, paint runs and nail heads, even tiny specks throw big shadows when critical light spills flush across a wall.

Pros often use critical light to catch flaws because a drywall finish job typically looks great until it's painted and illuminated

with critical light. Then the awful truth comes out, especially if the paint is glossy.

Pros avoid this by sanding and continually checking with a critical light from various angles. They use a high-power flashlight or a high-intensity lamp (that projects hard-edged shadows), sanding and tweaking until it's super smooth. Then they paint.

Sanding and checking with a light is critical.

\$154,300 U.S. * = (\$242,900 CDN.)

Extraordinary Buying Power! (in Windsor)

Minutes from Downtown Detroit!

Immediate Occupancy!

East Tower West Tower

Open House this Weekend!

From the incomparable riverfront view overlooking Belle Isle every detail defines a new benchmark in luxury living at The Gates of Glengarda.

GLENGARDA WINDSOR
www.glengarda.com

SALES CENTRE 4955 Riverside Dr E (519) 948-5211
Daily Noon-4pm • Closed Friday • Evenings by appointment

Toll Free (877) 948-5211 ext. 42

Bob Redler
Birkers Protected

200 RIVER PLACE LOFTS LUXURY LOFTS

OFFERING THE FINEST APPOINTMENTS:

- Unique Curved Entry Wall
- Maple Flooring Slate Flooring
- Interior Brick Walls
- Wood Beam Ceilings
- Exposed Ductwork
- Spacious Living and Dining Area
- Contemporary Kitchen with Complete Modern Appliance Package
- Soaring Windows
- Fine Tiled Baths
- Laundry with Washer and Dryer
- Gas Fireplaces with Slate Hearth

LOFTS PRICED FROM \$200,000 TO \$500,000

STROH RIVER PLACE DISTRICT
800.678.0406
www.farbmanliving.com

Century 21 Associates

Old Village REALTY
(734) 737-9400
"The Team You Need To Know"

Real Estate Sales & Service

995 N. Mill St. Plymouth, MI

Equal Housing Opportunity

MYSTIC FOREST ESTATE SIZE LOTS ANN ARBOR, MICHIGAN

25 HOMESITES ON 46 ACRES

- > Underground Utilities
- > Trail System
- > Lower Level Walk-Outs
- > Lots From \$120,000
- > Ann Arbor Schools
- > 18 Acres of Open Space

Plymouth Road West of Ford Road 1/2 Mile on North Side

Phone **1-248-344-9660**

WEB SITE mysticforesthomes.com

RICHARD E GILBERT
BUILDER INQUIRIES WELCOME

Luxurious Estates In Beautiful Metamora Township
20 Minutes from DaimlerChrysler Headquarters I-75 and M-59

MOUNT CHRISTIE ESTATES

Sophisticated Country Lifestyle... with All Suburban Conveniences

Luxurious custom estate homes nestled around the mountains of a former ski resort for incredible year-round views of the rolling hills of beautiful Metamora Township known throughout the country for spectacular equestrian estates and lush green meadows where horses romp playfully through the grass.

Mount Christie Estates offers a luxurious and sophisticated country lifestyle, close to all the conveniences of Oakland County's most desirable suburbs including Auburn Hills Birmingham Bloomfield Rochester and Troy. The exclusive Somerset Collection is only 35 minutes away.

MANY OUTSTANDING AMENITIES:

- Large estate-sized custom building sites each with interesting and unique geographical features to really "showcase" your beautiful custom home
- Private equestrian club with swimming pool tennis courts barn stables pasture paddocks and miles of scenic trails for riding hiking and skiing
- Spectacular outdoor entertainment decks overlooking rolling wooded landscape ravines ponds and natural wildlife
- Lower level walkouts with high ceilings bay windows and French doors opening onto landscaped brick patios
- Spacious floor plans 3,000-7,000 square foot
- Large elegantly appointed master suites with fully equipped "spa" type baths
- Gourmet kitchens • Multiple fireplaces • Three car garages

Spectacular homesites from \$138,000 to \$300,000
Luxurious custom homes from \$600,000 and up
See for yourself where your dreams can come true.

(248) 969-0400
Broken hills protected. Qualified builders welcomed.

Mount Christie Estates... An "Elegant" Country Lifestyle

"Big City Elegance Country Charm"

The Enclave
Elegant & Spacious Condominium Living

The Enclave combines the luxury and convenience of a modern city with the peaceful satisfaction of country life. Behind the security of the 24-hour gatehouse lies your escape from the ordinary.

- Idyllic surroundings • Vast elegant interiors • Indoor pool saunas spa fitness
- Civilized community • Shopping movies restaurants

"You Deserve Life in The Enclave"

Two bedrooms, two baths • Chef's kitchen with breakfast nook • Formal living and dining rooms
Separate den plus a year round sunroom filled with natural light • A cosmopolitan home spanning roughly 2,200 square feet in the midst of a tranquil country setting

Priced From \$305

Access The Enclave via Twelve Oaks Mall • 43050 Twelve Oaks Crescent Suite 1011 Novi Michigan 48377
Model Open Daily • (248) 348 8866 • Fax 348 0610 • www.enclavecondos.com

Classified Advertising

JOBS & CAREERS

South District Library
223 S. Main Street
Plymouth, Mich. 48170
500-599

Sunday, September 9, 2001

Classified Ad Index

CLASSIFICATION	NUMBER
■ Employment	500-599
■ Announcements	600-690
■ Merchandise	700-754
■ Autos/RVs	800-876
■ Autos By Make	834-874
■ Boats, Motors	802
■ Motorcycles, Mini Bikes	807
■ Trucks	822

Our complete index can be found on the second page of Real Estate section

TO PLACE AN AD

DIAL CLASSIFIED DIRECT

Wayne County	(734) 591-0900
Oakland County	(248) 844-1070
North Oakland County	(248) 475-4596
Rochester/Rochester Hills	(248) 852-3222
Fax your ad	(734) 953-2232

Walk-In Office Hours:
Monday - Friday, 8:30 am-5 pm
After Hours: Call (734) 591-0900 to use our 24-Hour Voice Mail System

Deadlines: For placing, cancelling or correcting of line ads.

Publication Day	Deadline
Sunday	5:30 P.M. Fri.
Sunday Real Estate	5:30 P.M. Thurs.
Thursday	5:30 P.M. Tues.
Thursday Real Estate Display	5:30 P.M. Mon.

You can view the Observer & Eccentric Jobs and Careers on the web at:

<http://www.ceonline.com>

CAMPUS JOBS

A campus job is convenient, rewarding

BY DIANE GALE ANDREASSI
SPECIAL WRITER

Juggling a load of college classes and working is tough, but finding a job on campus can make it easier. Mervat Kashou, the mother of three children, 13, 12 and 10, praises the benefits of a college campus job. She spent five years working at various jobs at Schoolcraft College while she completed an associate's degree in office information systems. Currently, she works as an assistant in the learning assistance center at the school. "It's very convenient to work and go to class," the Livonia resident said. "They're very flexible with my hours and they can work around my schedule. And if you have to leave for your kids, it's not going to be a problem." Rachel Holden, 18, works in career planning and job placement at Schoolcraft, and is taking a full load of classes while working toward an associate's degree in liberal arts. In fact, she said, her schedule is so flexible that if she has 90 minutes between classes she can go to work and get paid instead of trying to wile away the time.



STAFF PHOTO BY BRYAN MITCHELL

Close at hand: Mervat Kashou has found that working on campus at Schoolcraft College was a convenient way to study and earn some money.

The Westland resident and John Glenn High School graduate usually puts in about 13 1/2 hours weekly doing basic office work, like typing, filing, answering phones and copy machine work.

"I don't have to drive anywhere else to go to work," she said. "I just walk across campus."

Kashou and Holden are among college students who say their jobs offer convenience, special learning experiences and a chance to make important acquaintances that might help them in their careers.

"There are all sorts of student assistant jobs that are available to people who qualify and they really are pretty good learning opportunities for students, particularly in office positions where they can get a lot of experience and take on some good responsibilities," explained George Cartsonis, Oakland Community College director of communications.

Oftentimes, these college positions are their first jobs and they learn basic work ethics, like punctuality, appropriate behavior and how to relate to co-

workers and clients.

One of the biggest and most obvious benefits of working on campus, Cartsonis said, is the chance to defray some of the costs of taking classes and buying books.

"Plus it looks very good for them on their resumes to be able to say that you've worked at a college," he said. "The most important thing is to acclimate students to the work environment, because it's the most valuable experience they can get. We're very pleased to make these opportunities available to students."

Since there's a high turnover rate among student employees, the college office and department managers expect constant retraining responsibilities on their part. These bosses likely won't be as frustrated with people staying a short time as managers in other places of employment.

"We understand that if someone has an important test that means a lot that they might not be able to work," Cartsonis said. "That presents an opportunity for another student to

Please see **CAMPUS G2**

Follow the 3 E's for career decisions

Q. I want to help my 15-year-old daughter make some career decisions.

What fields will be open to college graduates in five to seven years?

A. All of them. I haven't seen one "Field Closed" sign lately. The best early career decisions are those in which factors such as earnings, potential, security, projected growth and parental aspirations are relatively secondary. Truly successful people have figured out the primary issue - what they love doing - and have pursued that vocation with persistence and vigor. Of course, we have to sprinkle in a little reality here. The NBA and rock super stardom are long shots. Better have a Plan B. Vocational consultants agree, however, that people who enjoy their work are often more energetic, productive and creative. As a result, they are sought after, make more money and, eventually, make their parents proud. Unfortunately, most young people make far-reaching career decisions out of ignorance. Dad wants Junior to be a doctor (lots of dough). Uncle Ralph encourages him to get a job in a union shop (it's your only security). Then again, the lawyers on TV seem to be having lots of fun.

School counselors usually aren't equipped to help either. The student to counselor ratio is often astronomical and there isn't time for a lot of focused, individualized attention.

Give your daughter the three E's: Exposure. Most kids make career decisions based upon what they think a job entails. They make assumptions based on hearsay or images manufactured in Hollywood. But visits to the plant floor or the offices of friends in

Please see **DECISIONS, G2**

Observer & Eccentric

EMPLOYMENT

Your classified ad is automatically posted on the internet! Visit us today

500's Employment

500 Help Wanted-General	532 Students
501 Help Wanted Computer/Info Systems	534 Jobs Wanted Female/Male
502 Help Wanted Office Clerical	536 Childcare Services Licensed
503 Help Wanted Engineering	537 Childcare/Babysitting Services
504 Help Wanted Dental	538 Childcare Needed
506 Help Wanted Medical	540 Elderly Care Services
508 Help Wanted Food/Beverage	550 Summer Camps
510 Help Wanted Health & Fitness	560 Education/Instruction Business & Professional Services
512 Help Wanted Sales	564 Financial Services
520 Help Wanted Part Time	566 Secretarial Services
524 Help Wanted Domestic	570 Attorneys/Legal Counseling
526 Help Wanted-Couples	572 Tax Services
530 Entertainment	574 Business Opportunities

Policy

All advertising published in The Observer & Eccentric is subject to the conditions stated in the applicable rate card. Copies of which are available from the Advertising Department, Observer & Eccentric Newspapers, 36251 Schoolcraft Road, Livonia, MI 48150. (734) 591-2300. The Observer & Eccentric reserves the right not to accept an advertiser's order. Observer & Eccentric Ad Takers have no authority to bind this newspaper and only publication of an advertisement shall constitute final acceptance of the advertiser's order.

Please Check Your Ad

The Observer & Eccentric will issue credit for typographical or other errors only on the first insertion of an advertisement. If an error occurs the advertiser must notify the Customer Service Department in time to correct the error before the second insertion.

HELP WANTED
Employment/ Instruction Services
#500-598

500 Help Wanted General
ACCOUNTANT
Farmington Hills property management company seeking an inquisitive individual with 2-3 yrs of experience as a financial analyst. Analytical & spreadsheet analysis skills a must. Benefits include competitive salary (\$5K-40K), medical/dental & 401K. Forward resume to: Financial Analyst Position, P.O. Box 339687, Farmington Hills, MI 48333. Fax: 248-737-1457.

500 Help Wanted General
ACCOUNTANT
For quality oriented CPA firm. Minimum 3 yrs public accounting experience. Will consider major part time. Flexible hours. E-mail resume to: jsc@chapnickcpa.com. Or fax: (248) 855-7781.

500 Help Wanted General
ACCOUNTANT LARGE
Insurance corporation seeks qualified individual for our expanding accountant department. Position requires 3 to 5 years experience in an insurance environment. Responsibilities include account analysis, tax and budget compilation and financial reporting. CPA required. Send resume including salary history to Controller at: Jobs@BurnsWilcox.com. Fax: 248-932-8040.

500 Help Wanted General
ACCOUNTANTS
The Farmington Hills based CPA firm of Boyes Wright Pittman & Co P.C. is seeking experienced and/or entry level accountants. Bachelor Degree in Accounting is required. Demonstrated technical/accounting experience in the private or public sector is preferred. However, academically qualified applicants are welcome to submit a resume. BWP is a full service Accounting and Computer Consulting firm to small and medium size businesses. This opportunity offers a competitive compensation and benefit package. Please respond to: Brenda Schulmeister, BWP P.O. Box 2719, Farmington Hills, MI 48333-2719. Fax your resume: 248-855-4387. E-mail: bschulmeister@bwpco.com

500 Help Wanted General
ACCOUNT EXECUTIVE
Hometown Newspapers has a full time sales position available for an outgoing, energetic team player to join our outside advertising sales staff in our Novi location. Qualified candidates will possess an Associate's degree prior sales experience, excellent customer service skills and computer knowledge. Must have dependable transportation. We offer base salary plus commission and excellent benefit package. Please mail or fax resumes to job code Sales to: Hometown Newspapers, 323 E Grand River, Howell, MI 48843. Fax: (517) 548-5545. E-mail: mbartlett@hnt.com

500 Help Wanted General
ACCOUNT EXECUTIVE/ EVENT SALES
HSS Rentex Special Events is looking for a dynamic motivated individual. Previous sales or event exp a plus. Salary Determined by exp. 401k w/ company match, health, dental vision. EOE. Apply to: HSS Rentex Special Events, Abruzzi, Dr. 734-728-9225 or Email resume to: partyrentals@rentex.com

500 Help Wanted General
ACCOUNTING SPECIALIST
Oakland Community College is currently accepting applications for the position of Accounting Specialist in the Financial Services Department at the District Office. MINIMUM QUALIFICATIONS: Associate's Degree in Accounting, no substitutions permitted. Successful completion of Clerical Skills Battery Computer keyboard proficiency of 60 wpm. Ability to work as a team player in a multi-cultural diverse working environment (more detailed information is available for this position on the OCC web site at occ.cc.mi.us). Applicants MUST complete an application form. Requests for applications will be accepted through 5:00 p.m. on Monday, September 24, 2001. Contact the OCC Job Hotline at (248) 341-2023 and refer to Position 01C55-10842. OCC is an Affirmative Action/Equal Opportunity Employer.

500 Help Wanted General
ACTIVITY ASSISTANT
Part time position available for long term assisted living facility for religious women. Salary negotiable with education & experience. Send resume to: McAuley Center Attn C Nguyen, 28750 11 Mile Rd Farmington Hills, MI 48336.

500 Help Wanted General
Act Now! INSPECTORS/ PACKAGERS
Immediate openings for day and afternoon shifts. No experience needed. Must be able to work 40 hrs per week. Call today work tomorrow. (248) 477-0513. ARCADIA

500 Help Wanted General
AIR FREIGHT
Est. air freight/expressing Co seeking customer service oriented OPS Agent. AF exp & computer skills are required. Send resume to: Personnel 29101 Airport Dr, Romulus, MI 48174. Fax: 734-946-1443.

500 Help Wanted General
ALL POSITIONS AVAILABLE
New co in Plymouth looking for young minded hard working men & women for full positions. * Flexible hours for students * • \$400 Per Week • Bonus/Incentives • Paid Vacations • Scholarships. Applicants must work well with opposite sex. Call 734-737-8905 for immediate interview.

500 Help Wanted General
ANIMAL SHELTER ADOPTION COUNSELOR
The Michigan Humane Society has immediate full time openings at the Westland Shelter. Strong customer service and communication skills a must. Prior animal handling skills a plus. However, will train. Five days a week including Saturdays. Benefits include paid medical/dental. Apply in person at 37255 Marquette Rd Westland, MI.

500 Help Wanted General
AQUATIC COORDINATOR
See website localjobs.com Reference #2132 for details Farmington YMCA

500 Help Wanted General
APARTMENT MANAGER
For Detroit property. Must have experience in property management. Please fax resume to: 248-352-2837. EOE

500 Help Wanted General
APPLIANCE REPAIR (WILL TRAIN)
\$700/wk + benefits. Opportunity to earn \$1400/wk. 734-523-0016.

500 Help Wanted General
ARCHITECTURAL/ INTERIOR DESIGN FIRM
Has immediate CAD position for person w/strong ACAD skills. FT/PT. Fax: (248) 855-7744. Email: howard@daviddesign.tv

500 Help Wanted General
ASPHALT PAVING
Well established co seeking experienced personnel in all phases of asphalt paving. Drivers license required. Health dental 401k & paid holidays. 734-722-5650.

500 Help Wanted General
ARTISTICALLY INCLINED
If you enjoy using your creative abilities such as painting ceramics, nail art, floral arrangements and other types of crafts etc. then come down and apply for a chance to work in a job that will challenge you! WE WILL TRAIN \$8.00 per hr to start. Overtime and Saturday work required during peak seasons. Raises and promotions based on job performance. We offer a good benefits package as well as advancement potential. Casual attire. Apply in person: North American Photo, 27451 Schoolcraft at Inkster, Livonia, Mich.

500 Help Wanted General
ASSEMBLY & LIGHT PACKAGING
Mon - Fri. Days & afternoons. No heavy lifting. Livonia location. 313-319-6884. Acoloché Staffing.

500 Help Wanted General
ASSEMBLY & MOLDING OPERATORS
Injection molder located in Canton has an opportunity for assembly & molding operators for 2nd shift. Excellent pay & benefits. Please fax resume to: 734-451-9713 or mail to: P.O. Box 51580, Livonia, MI 48150.

500 Help Wanted General
AUTO BILLER
For fast growing dealership. Temporary position. Dealership exp preferred but will train. Forum Chrysler Jeep Dodge. Contact Ann (810) 714-3300.

500 Help Wanted General
ASSEMBLY
Argent Automotive Systems Inc. producer of self adhesive die cut components is looking for part time Assemblers. Please inquire at: 41131 Vincetti Ct Novi, MI 48375. 248-473-0500.

500 Help Wanted General
ASSISTANT MANAGER TRAINEES
Heslop's. Qualified applicants will possess strong leadership abilities & retail background. \$24,000 to start. Fax resumes: 248-344-4342 or mail to Heslop's, 22790 Heslop Dr, Novi, MI 48375. Attn: Personnel.

500 Help Wanted General
AUTOMOTIVE BRAKE & FRONT END TECHNICIAN
Busy auto repair facility seeking state certified tech. Top commission 401k, medical benefits, w/earnings between \$50,000-\$85,000/year. Nov Motive Inc. 21530 Novi Rd between 8 & 9 Mile. Call 248-349-0290.

500 Help Wanted General
AUTO BODY SHOP ASSISTANT MANAGER
Experience preferred. Will train. Night individual. Reply to: Box #1250, Observer & Eccentric Newspapers, 36251 Schoolcraft Rd, Livonia, MI 48150.

500 Help Wanted General
Auto BODY MEN
Large Lincoln Mercury dealership looking for qualified individual. Plenty of work. Great pay. Full benefits and pension plan. Steering and suspension experience a plus. Apply in person: 32000 Ford Rd, Garden City.

500 Help Wanted General
AUTO BODY SHOP
Immediate openings for: • TECHNICIANS • PAINTERS • PORTERS. For large GM dealership. Techs & painters should have a minimum of 5 years experience. Porters must have good driving record. We offer excellent pay & benefits. Apply in person at: DON MASSEY, 40475 Ann Arbor Rd, Plymouth.

500 Help Wanted General
AUTO BODY TECHNICIAN
Busy DRP Shop. Paid vacation. 401k. Full Benefits. Keford Collision, 39588 Grand River, Novi, MI (248) 478-7815.

IMAGINE THIS SALES CAREER

- Customers want your help
- No prospecting - customers come to you
- No manipulating - just help customers
- No pressuring - you're on the customers side
- The better you help people the more \$ you make
- High commissions with integrity
- High tech combined with high "touch"
- Top rental consultants earn \$40,000+
- Teamwork, benefits, training pay

Send Fax or Email resume to: RC Resumes, D.B., 28557 Woodward Ave • Berkley, MI 48072. Fax: 248-414-9557. Email: dbretz@ApartmentSearch.com

IMMEDIATE OPENING IN CANTON & ROYAL OAK

8 Metro Area Locations / SPECTRUM Apartment Search

Vice President & General Manager

Hometown Communications Network Inc. is seeking outstanding candidates for the top executive position in its largest subsidiary, The Observer & Eccentric Newspapers, headquartered in Livonia, Michigan. The O&E publishes 16 twice weekly state and national award winning community newspapers as part of Hometown's total 69 weekly twice weekly and daily community newspapers with a combined circulation of 800,000.

Preferred candidates will have at least a bachelor's degree with five or more years of significant accomplishments in newspaper management and a record of achievements that demonstrates the skills needed to lead the O&E through a climate of change with progressive results.

The position includes full P&L responsibilities for the O&E and several other newspapers in an affiliated property and has the support of dedicated employees in every department of the company. A very competitive cash and benefits compensation package will be available to the successful candidate.

Reply in confidence to: David Karapetian, Vice President Human Resources, Hometown Communications Network, 36251 Schoolcraft Road • Livonia, MI 48150. Email: dkarapetian@homecomm.net. Fax: (734) 591-9424.

Campus from page G1

take his place"
 At Schoolcraft College there are some 200 students who work on campus in a plethora of jobs, like office work, as a cashier in the bookstore, in the culinary arts department working on special events or in the physical education building directing visitors to classes and activities.
 The pay range is just as diverse as the job responsibilities starting at \$6 and rising to about \$10 hourly depending on how long they've worked on the campus and on the complexity of the job.
 "The college understands that you are a student first and an employee second," explained Donna Nordman, Schoolcraft College coordinator of placement services.
 Besides saving gas and time driving to a job, Nordman tells students there are other benefits.
 "Instead of going to class and going home, you become very acquainted with other classes, other resources and other opportunities," she said.
 "They get to meet more people who might give them information about their career paths."
 Supervisors don't view student employees as workers, Nordman said, but as teaching opportunities.
 "It's not like you're going to go into an off campus job and someone will say 'You didn't do that right.' They're going to say 'Here let me show you that again.'"
 Nordman recalled a student who worked part-time on the Schoolcraft switchboard. She graduated with a liberal arts degree and landed a job with a consulting firm.

"Much of her customer service experience she learned was on campus on switchboard," Nordman said.
 Most of the student jobs at Madonna University require good communication and computer skills, explained Ingrid Kroeger, assistant director of career services. Jobs range from helping students trouble shoot problems in the computer lab; transporting media services equipment, shelving books and helping students in the library, and working in video communications.
 Pay rates begin at \$5.15 hourly and rise to reflect experience and skills. Raises are administered regularly.
 Students who work in the computer lab get the extra perk of learning a number of programs.
 "The staff is giving them additional training," Kroeger said.
 "The students really do get to know a lot of the faculty and staff. So the students get a good feel for the university beyond just coming and going."
 Bob Thomas, Oakland University director of placement and career services, tells freshmen who are looking for work to consider doing something on campus, especially during the first 12 to 18 months.
 It's a chance to learn how the university works and how to navigate through the system.
 "It's an opportunity to get good work ethics in a learning environment and they can make a connection with the university," Thomas said. "When you come on campus as a freshman you don't know anybody."

Decisions from page G1

different professions create real knowledge. Summer work can clarify likes and dislikes. Groups like Junior Achievement and Explorers provide hands-on experience. Vocational testing (in a private setting) can point to fields worth investigating. The more varied the exposure, the better.
 Encouragement. Use your powers of observation to articulate what your child likes to do. On the other hand, be slow to conclude that any one field would be inappropriate. Often, one bad or frustrating experience will turn a kid off to an occupation that might have been perfect. Once a passion is expressed, reinforce it. Ask questions about related activities and studies. Express pride in your child's knowledge and progress.
 Energy. Don't watch passively and hope that things "turn out." Do something. Extend yourself to pay for lessons or books. Initiate and review projects seriously. Together, identify and talk to professionals in the field. Visit campuses.
 Just be careful not to let it become your thing. In a teenager's mind, there is a fine line between encouragement and pressure. Also, be willing to abandon a vocational idea once enough information has been gathered and processed. Helping your daughter figure out what she doesn't want to do is important, too.

George Hayes is an outplacement consultant and regular columnist. Contact him through www.emplexcorp.com

Observer & Eccentric EMPLOYMENT

Your classified ad is automatically posted on the internet! Visit us today

<p>500 Help Wanted General</p> <p>AUTO BODY TECHNICIAN For Westside Ford dealership. Excellent pay plan & benefits including Blue Cross/Blue Shield dental prescription 401K life & disability insurance 5 day work week. Call Blackwell Ford at (734) 453-1100</p>	<p>500 Help Wanted General</p> <p>Automotive Appointment Coordinator Jaguar of Troy is looking to fill a very unique/important position in our busy service department. We are seeking an energetic individual with great people skills. Previous dealership experience helpful. Candidates must possess strong communication and organizational skills with attention to detail while being able to handle a fast paced environment. We offer a competitive pay plan that includes BC/BS life 401(k) and CSI bonus. Contact us at 248-614-3183 or fax or e-mail resume to FAX# 248 643 7980 jvwalsley@jaguarofroy.com</p>	<p>500 Help Wanted General</p> <p>AUTOMOTIVE LOCKOUT SPECIALIST Assist stranded customers who have locked their keys in their vehicle. Candidate must possess customer service experience, clean driving record and good oral and written skills. No experience necessary as will train. WE offer paid training and medical and life insurance. Full time shifts available including weekends. Drug free work environment. Call (313) 336 5880</p>	<p>500 Help Wanted General</p> <p>AUTOMOTIVE WARRANTY ADMINISTRATOR Jaguar of Troy has an immediate opening for a qualified and professional individual. Candidates must be highly organized with interpersonal skills to deal with the volume created by being the #1 Jaguar dealership in the country. ADP experience is a plus. We offer a very competitive wage with benefits that include BC/BS life 401(k) and CSI bonus. Contact us at 248 614 3183 or fax or e-mail resume to jvwalsley@jaguarofroy.com</p>	<p>500 Help Wanted General</p> <p>Automotive Technician Opportunity of your lifetime! Livonia family owned & operated repair facility that's been in business for over 22yrs. Needs One quality technician. If you want work we've got plenty! If you have exp. of a master tech you can write your own paycheck. WE OFFER Quality repairs Top wages Paid vacation after 1yr. Uniforms. We pay for your health insurance & provide low cost insurance for your family. Work Mon - Fri 8 to 6pm. Co paid continued technical education. Provided our teeny loaner cars to customers, if car not completed on done day. THINGS WE DON'T DO Work cheap just for a sale. Don't work on "JUNK". Don't tolerate childish attitudes. Don't hire too many techs so nobody makes money. If you're this person don't hesitate to call Joe at (734) 522 7333 during hours of operation or fax resume to 734-522-7583. REMEMBER, Your Future Is In Your Hands.</p>	<p>500 Help Wanted General</p> <p>AUTO SERVICE PORTER Joe Panian Chevrolet has an immediate opening for a part time morning Service Porter. Must have excellent driving record. Please apply in person to Ron Griffin Service Manager. Joe Panian Chevrolet Medium Duty Truck Center 28111 Telegraph Southfield</p>	<p>500 Help Wanted General</p> <p>Banking Positions Flagstar Bank is still expanding rapidly and seeking growth minded candidates to fill the following positions in Detroit and surrounding areas: Traditional Branch Teller and Customer Service Representatives These positions involve direct customer contact handling their financial transactions. Requires excellent customer service skills. Previous banking experience required for customer service rep position. We offer an excellent benefit package including health dental and life insurance company matching 401(k) paid vacations holidays and tuition reimbursement. Career advancement opportunities available! To apply for these exciting opportunities please call 1 877 632 8403 Equal Opportunity Employer</p>
--	---	---	--	---	--	--

COOKER NOW HIRING ALL POSITIONS

Jim and Jill

Apply Anytime!

Competitive Wages • Flexible Schedules • Great Benefits

<p>LIVONIA 38703 Seven Mile Road (734) 462-3650</p>	<p>CANTON 41980 Ford Road (734) 981-6595</p>	<p>NOVI 39581 Twelve Mile Road (248) 380-2600</p>
--	---	--

ROUSH INDUSTRIES JOB FAIR
 SATURDAY, SEPT 15, 2001 from 10AM-3PM, 28400 Plymouth Rd Livonia, MI
 Roush is hiring We have current openings in the following positions:
 ■ AUTO MECHANICS ■ DIESEL MECHANICS ■ SHEET METAL FABRICATORS ■ INSTRUMENTATION TECHNICIANS ■ WIRE LAB TECHNICIANS ■ VEHICLE BUILD COORDINATORS
 Maps and directions on our website. Competitive wages. Full company-paid benefits package. Bring your resume to our Job Fair or send it to Roush Industries 11851 Market Street Livonia, MI 48150 Fax 734 779 7804 Email careers@roushind.com website www.roushind.com EOE

AUTO PARTS COUNTERPERSON
 Westside Ford dealer is accepting applications for an experienced parts person. Competitive pay and benefits. Apply in person to Jim Clark Parts Mgr. BLACKWELL FORD 41001 Plymouth Rd Plymouth Twp

AUTO PORTER
 Help wanted Auto Porter part time 5 days 20 hours per week, \$7.00 per hour must pass drug screening must have good driving record. Call Marv Yager at Hines Park Lincoln Mercury (734) 453-2424 ext. 248 or apply in person at 40601 Ann Arbor Rd in Plymouth

AUTO PORTERS
 Joe Panian Chevrolet has an immediate opening for a full time New Car and Truck Department Porter. Must have excellent driving record. Please apply in person to Tom Amdt New Car Manager. Joe Panian Chevrolet Medium Duty Truck Center 28111 Telegraph Southfield

BARTENDERS WANTED Earn up to \$250 per shift. Make \$\$\$ get Trained Fun Exciting Environment. Call 800-806-0085 ext 201

FIRST FEDERAL OF MICHIGAN

THE Observer & Eccentric NEWSPAPERS

It's all about RESULTS! Part of HomeTown Communications Network™

HomeTown Newspapers

Fall Job Fair

Burton Manor, Livonia
 Wednesday, September 19, 2001 • 11 a.m. - 6 p.m.

Take advantage of this great opportunity to check out a new job. Talk to recruiters from throughout the metropolitan area who are eager to discuss a new career or a career change with you.

You'll have access to a wide range of jobs and meet a lot of friendly people who are interested in you and your career goals. Appropriate business attire appreciated.

Participating companies include

Absopure Water ■ Apple Dental & Implant Center ■ Comcast Cable Communications ■ Dearborn Federal Credit Union
 Enterprise Leasing Company of Detroit ■ Fifth Third Bank ■ First Federal of Michigan ■ Flagstar Bank, FSB
 Henry Ford Museum & Greenfield Village ■ H&R Block Financial Advisors, Inc. ■ HomeTown Newspapers ■ Interfirst Wholesale Mortgage Lending
 Kinko's ■ The KPM Group ■ Marquette Management ■ Mattress & Futon Shoppes ■ Observer & Eccentric Newspapers
 Payroll 1, Inc. ■ Plastipak Packaging ■ Providence Hospital & Medical Centers ■ Red Wing Shoes
 Sears Roebuck & Company ■ Snelling Personnel Services ■ Staff Pro America ■ TCF Bank ■ United Parcel Service
 ■ Virginia Tile ■ Westland Convalescent Center

Banking ■ Finance ■ Engineering ■ Management
 Office Clerical ■ Computers ■ Healthcare ■ Manufacturing
 Sales ■ Retail ■ Skilled Trades and more

Find your dream job!

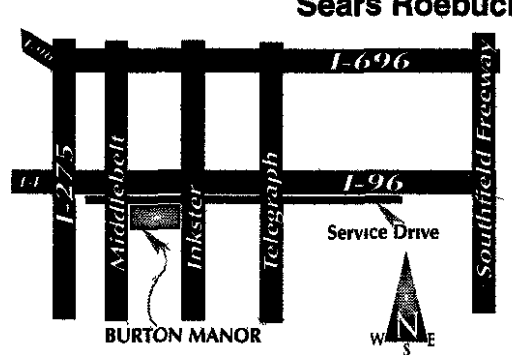

Attention Readers

Place a Garage Sale Ad and be eligible to win a \$50 gift card from Meijer, Inc.



One winner per week! Winner's name will be published every Thursday in this section

Observer & Eccentric

CLASSIFIEDS

It's all about RESULTS!

Part of The HomeTown Communications Network™
www.observer-eccentric.com

IT'S EASY TO PLACE YOUR CLASSIFIED AD JUST CALL, FAX or E-MAIL



IT'S EASY TO FIND IT BUY IT SELL IT IN THE CLASSIFIEDS



- OAKLAND COUNTY 248-644-1070
- WAYNE COUNTY 734-591-0900
- ROCHESTER AREA 248-852-3222
- CLARKSTON, WATERFORD 248-475-4596
- TOLL FREE 800-579-SELL
- FAX YOUR AD 734-953-2232

24 HOUR VOICE MAIL and E-MAIL
BOOKMARK OUR WEBSITE
www.observer-eccentric.com

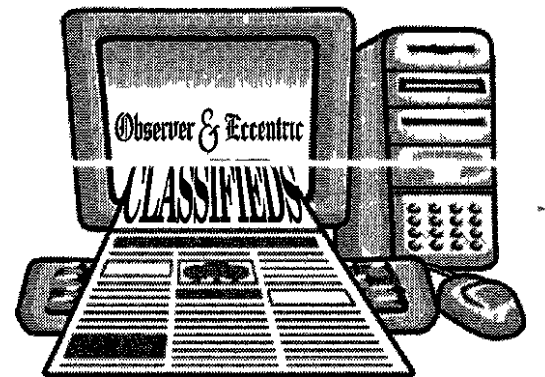

All Our Ads Are Online!
You can place your ad 24/7
Sure to be a Favorite Site

WE HONOR



DEADLINES:

For Placing, Cancelling or Correcting of Liner Ads.

Publication Day	Deadline
SUNDAY REAL ESTATE	5:00 P.M. THURSDAY
SUNDAY ISSUE	5:00 P.M. FRIDAY
THURSDAY	5:30 P.M. TUESDAY

Walk-In Office Hours:

Monday - Friday 8:30 am - 5:00 pm

OBSERVER SALES OFFICE
36251 Schoolcraft, Livonia, MI 48150

ECCENTRIC SALES OFFICE
805 East Maple, Birmingham, MI 48009

Policy

All advertising published in The Observer & Eccentric is subject to the conditions stated in the applicable rate card copies of which are available from the Advertising Department. Observer & Eccentric Newspapers, 36251 Schoolcraft Road, Livonia, MI 48150 (734) 591-2300. The Observer & Eccentric reserves the right not to accept an advertiser's order. Observer & Eccentric Ad Takers have no authority to bind this newspaper and only publication of an advertisement shall constitute final acceptance of the advertiser's order.

Please Check Your Ad

The Observer & Eccentric will issue credit for typographical or other errors only on the first insertion of an advertisement. If an error occurs the advertiser must notify the Customer Service Department in time to correct the error before the second insert on.

Home & Service Guide #001-245	Real Estate For Sale #300-389	Commercial Industrial Sale or Lease #389-398	Real Estate For Rent #400-498	HELP WANTED Employment/Insurance Services #500-598
Announcements #600-698	Merchandise #700-778	GARAGE SALE Garage Sale Moving Sale #711-713	Animals Pets/Livestock #780-798	Automotive Recreational Vehicles #800-899

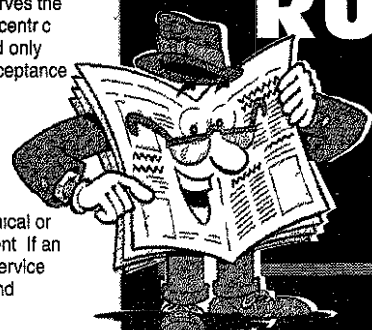

RUN IT UNTIL IT SELLS!
1-800-579-SELL

Give your Observer & Eccentric Classifieds a call today and we'll tell you how to "Run It Until It Sells!"

Applies only to all transportation classifications.

Helpful Hints:

For the best results when writing your classified ad, put yourself in the readers/buyers shoes. Describe the items for sale or job opening by including details that would attract your friends. Avoid abbreviations. Include a phone number and best times to call. Include price/salary range, and benefits. Include an e-mail address if possible, because your ad also appears on our internet site. Use key wording for easy searching and reading. List age, brand, style and condition of items. Don't be afraid to ask our friendly, professional staff for help. Remember you want results, so the more you tell and the more people your ad reaches, the more responses you will receive. **Call us today, we can help you!**

500 Help Wanted General

TELLERS
STANDARD FEDERAL BANK member ABN AMRO Group has immediate openings for full time and part time Tellers. Light typing, good math aptitude and customer service skills required. Must also have one year of cashier experience. We provide the training you'll need helping you learn valuable business skills that can lead to advancement.
In addition to learning valuable job skills, you'll also receive competitive pay and an attractive benefits package. Part time employees working 20 or more hours per week are eligible for medical coverage paid holidays on days regularly scheduled to work. Full time assistance and paid vacation. Pay rate is \$9.50/hour.
Please bring your resume. Human Resources Representative will be available.
Tuesday Sept 11 10am to 2pm at
940 E Long Lake Rd Troy MI
Or send your resume to
STANDARD FEDERAL BANK
Human Resources Dept
2600 W Big Beaver Rd Troy MI 48064
Fax (248) 837-2759

BUYER
Northwest area medium sized company seeking a responsible experienced individual. Duties will include sourcing/procuring issues analyzing quotations negotiating prices & terms with suppliers. Responsible for annual market tests. Must have excellent verbal/written & interpersonal skills. Forward resume & salary requirements to
Attn: HR Department
12285 Dixie
Redford MI 48239
Fax 313 531 5243

BUYER TRAINING
\$35K/yr + Benefits & Parks Degree + 1.2 yrs buying experience preferred. Must have excellent math skills. Award winning co. in Beauty Industry Farmington/Novi area. FEE PAID Employment Center Agency (248) 569 1636

CABLE TV Installers
Need dependable hardworking people to run cable TV wiring. Opportunity for advancement. Must have valid drivers license & good work references.
Call (313) 255 3142

CARETAKER COUPLE needed for upscale apt. complex in Livonia position requires one person for Full Time maintenance (must have own tools) as well as one person full time for Leasing. Benefits include spacious two bedroom private house excellent salary. Blue Cross. Please call Clarence (248) 851 9954 ext 226 or Kathy (734) 981 6460

CARPENTER & HELPERS for small remodeling company. Drywall experience. Full time good pay. 248 478 0816

CARPENTERS WANTED
Familiar with minimum 2 years experience. New construction and some remodeling.
734 328 0836 or 734 635 1606

CARPENTERS 1 yr Rough framing • Foreman positions available • 100% medical & dental • Pension plans 401K + 5 Paid holidays (734) 944 1011

CARPET CLEANERS
Top level cleaning Technician leading to Shift Supervisor. Benefits. Experience worth money! Call for appt (734) 425 4813

CARPET/WINDOW CLEANERS
\$12/hr + benefits. Will train. Good driving record a must. 40+ hrs/wk 734 285 6211

CASE ADMINISTRATOR
The office of the chapter 13 Standing Trustee located in Downtown Detroit has immediate opening. Responsibilities include Data input review and analysis of legal pleadings attend hearings respond to inquiries on cases. Excellent verbal and written communication skills and computer experience necessary. Legal (bankruptcy) background a plus. Salary range \$15-\$18 per hour. Salary commensurate with experience. Excellent fringe benefits including 401K, medical, dental, optical, life and disability. Please submit resume & salary requirements to
Chapter 13 Trustee
Attn Nancy Chapman
535 Griswold Suite 1230
Detroit MI 48226
Fax 313 965 1940 or Email nancy@det13ksc.com

CASHIER
for large hardware store in Wayne Full or part time. Competitive wages 734 721 7244

CHEMIST
Leading analytical laboratory has an immediate full time opening in their GC (gas chromatography) department. Position requires high school diploma and some college chemistry. Experience in OSHA/NIOSH methods and computer applications is a plus. Will train the right candidate. Send resume in confidence to: Ms. C. Kapsanis Clayton Group Services Inc 22345 Roethel Drive Novi MI 48375
fax number (248) 344 2855 or email to ckapsanis@claytongrp.com
No phone calls please EOE/AEE/M/F/H/V

LITTLE TOTS
is seeking responsible energetic and nurturing caregivers to work w/young children from 2:30 pm Mon-Fri To apply please call 734 591 6440

CHILD CARE PROFESSIONALS NEEDED
Learn While You Earn! The Learning Tree offers employees an Education reimbursement program and on site training. Along with 401K Retirement Plan, Medical/Dental Benefits, Paid Vacation/Holidays and Personal Days. Raise reviews by yearly Bonus Program.
Call 734 525 5767 or apply in person

LEAD CHILDCARE PROVIDERS
Needed for our All Day Pre school and School Age programs. Applicants must have completed CDA credential or 12 semester hours of credit in Early Childhood \$8.45-\$9.65/hr
SUBSTITUTES/CHILDCARE PROVIDERS
Needed for Preschool and School age Programs. Applicants must be at least 18 yrs of age with high school diploma or GED. Experience preferred but will train \$6.15-\$7.13/hr
Qualified applicants should apply in person at the Dearborn Public Schools Human Resources Department 18700 Audette Dearborn (313) 730 0580 EOE/AEE

CLEANING FLOATER
30-40 hrs/wk. Eves. Must be reliable \$9/hr Farmington area. Call 248-615-3554

CLEANING OFFICES
Novi Farmington & Southfield 2 1/2+ hrs eves. Mon-Fri 248 615 3554

CHEMIST
Leading analytical laboratory has an immediate full time opening in their GC (gas chromatography) department. Position requires high school diploma and some college chemistry. Experience in OSHA/NIOSH methods and computer applications is a plus. Will train the right candidate. Send resume in confidence to: Ms. C. Kapsanis Clayton Group Services Inc 22345 Roethel Drive Novi MI 48375
fax number (248) 344 2855 or email to ckapsanis@claytongrp.com
No phone calls please EOE/AEE/M/F/H/V

CHILD CARE ASSISTANT
Needed for Christian learning center in Plymouth. Full & part time positions. Flexible hrs. Benefits available. Call Dawn at (734) 455 3196

CHILDCARE CENTER
Has immediate openings for Assistant Teachers Redford area. Experience a plus. Degree not required. Sense of humor is (313) 541 1318

CLEANERS NEEDED
for commercial & residential. Call William 734 427 9930 or Fax resume 734 427 9934

CNC OPERATOR
On MOLDS only. Must have Heidenhain controller and work NC experience. 313 535 7631

COLLECTION ATTORNEYS
in Farmington Hills need additional Collectors. Retail collection exp helpful. 248 855 6562

CHECK THIS OUT!
Part/Full time positions available in customer sales/service. Positions offer:
• Flexible schedules
• Fun/professional setting
• Great for resume
• \$14.05 base appt
Positions require:
• Positive attitude
• Down to-earth
• Work well with others
734 522 4140 Call 11 6pm or visit workforstudents.com

CONSTRUCTION MANAGEMENT
Start up firm located in Farmington Hills has opportunities for Project Manager/Supervisor and Field Laborer. Immediate availability for commercial retail project. Fax resume to Controller 248 478 8514

COMPANION
For American House Senior Residence in Northville. After noon & midnight shifts available. Call Carol (248) 449 1480

CARPENTERS HELPER
wanted. Immediate. Full time position \$8.11/hr. Experience helpful. 313-387-9870

COUNTER HELP & Pressers
for dry cleaners. Good pay. Paid holidays. Maple/C Orchard Lk area. 248 626 0004

CONSTRUCTION MANAGEMENT
Start up firm located in Farmington Hills has opportunities for Project Manager/Supervisor and Field Laborer. Immediate availability for commercial retail project. Fax resume to Controller 248 478 8514

CHEMIST
Leading analytical laboratory has an immediate full time opening in their GC (gas chromatography) department. Position requires high school diploma and some college chemistry. Experience in OSHA/NIOSH methods and computer applications is a plus. Will train the right candidate. Send resume in confidence to: Ms. C. Kapsanis Clayton Group Services Inc 22345 Roethel Drive Novi MI 48375
fax number (248) 344 2855 or email to ckapsanis@claytongrp.com
No phone calls please EOE/AEE/M/F/H/V

CHILD CARE ASSISTANT
Needed for Christian learning center in Plymouth. Full & part time positions. Flexible hrs. Benefits available. Call Dawn at (734) 455 3196

CHILDCARE CENTER
Has immediate openings for Assistant Teachers Redford area. Experience a plus. Degree not required. Sense of humor is (313) 541 1318

CLEANERS NEEDED
for commercial & residential. Call William 734 427 9930 or Fax resume 734 427 9934

CNC OPERATOR
On MOLDS only. Must have Heidenhain controller and work NC experience. 313 535 7631

COLLECTION ATTORNEYS
in Farmington Hills need additional Collectors. Retail collection exp helpful. 248 855 6562

CHECK THIS OUT!
Part/Full time positions available in customer sales/service. Positions offer:
• Flexible schedules
• Fun/professional setting
• Great for resume
• \$14.05 base appt
Positions require:
• Positive attitude
• Down to-earth
• Work well with others
734 522 4140 Call 11 6pm or visit workforstudents.com

CONSTRUCTION MANAGEMENT
Start up firm located in Farmington Hills has opportunities for Project Manager/Supervisor and Field Laborer. Immediate availability for commercial retail project. Fax resume to Controller 248 478 8514

COMPANION
For American House Senior Residence in Northville. After noon & midnight shifts available. Call Carol (248) 449 1480

CARPENTERS HELPER
wanted. Immediate. Full time position \$8.11/hr. Experience helpful. 313-387-9870

COUNTER HELP & Pressers
for dry cleaners. Good pay. Paid holidays. Maple/C Orchard Lk area. 248 626 0004

CONSTRUCTION MANAGEMENT
Start up firm located in Farmington Hills has opportunities for Project Manager/Supervisor and Field Laborer. Immediate availability for commercial retail project. Fax resume to Controller 248 478 8514

CHEMIST
Leading analytical laboratory has an immediate full time opening in their GC (gas chromatography) department. Position requires high school diploma and some college chemistry. Experience in OSHA/NIOSH methods and computer applications is a plus. Will train the right candidate. Send resume in confidence to: Ms. C. Kapsanis Clayton Group Services Inc 22345 Roethel Drive Novi MI 48375
fax number (248) 344 2855 or email to ckapsanis@claytongrp.com
No phone calls please EOE/AEE/M/F/H/V

CHILD CARE ASSISTANT
Needed for Christian learning center in Plymouth. Full & part time positions. Flexible hrs. Benefits available. Call Dawn at (734) 455 3196

CHILDCARE CENTER
Has immediate openings for Assistant Teachers Redford area. Experience a plus. Degree not required. Sense of humor is (313) 541 1318

CLEANERS NEEDED
for commercial & residential. Call William 734 427 9930 or Fax resume 734 427 9934

CNC OPERATOR
On MOLDS only. Must have Heidenhain controller and work NC experience. 313 535 7631

COLLECTION ATTORNEYS
in Farmington Hills need additional Collectors. Retail collection exp helpful. 248 855 6562

CHECK THIS OUT!
Part/Full time positions available in customer sales/service. Positions offer:
• Flexible schedules
• Fun/professional setting
• Great for resume
• \$14.05 base appt
Positions require:
• Positive attitude
• Down to-earth
• Work well with others
734 522 4140 Call 11 6pm or visit workforstudents.com

CONSTRUCTION MANAGEMENT
Start up firm located in Farmington Hills has opportunities for Project Manager/Supervisor and Field Laborer. Immediate availability for commercial retail project. Fax resume to Controller 248 478 8514

COMPANION
For American House Senior Residence in Northville. After noon & midnight shifts available. Call Carol (248) 449 1480

CARPENTERS HELPER
wanted. Immediate. Full time position \$8.11/hr. Experience helpful. 313-387-9870

COUNTER HELP & Pressers
for dry cleaners. Good pay. Paid holidays. Maple/C Orchard Lk area. 248 626 0004

CONSTRUCTION MANAGEMENT
Start up firm located in Farmington Hills has opportunities for Project Manager/Supervisor and Field Laborer. Immediate availability for commercial retail project. Fax resume to Controller 248 478 8514

500 Help Wanted General

TELLERS
STANDARD FEDERAL BANK member ABN AMRO Group has immediate openings for full time and part time Tellers. Light typing, good math aptitude and customer service skills required. Must also have one year of cashier experience. We provide the training you'll need helping you learn valuable business skills that can lead to advancement.
In addition to learning valuable job skills, you'll also receive competitive pay and an attractive benefits package. Part time employees working 20 or more hours per week are eligible for medical coverage paid holidays on days regularly scheduled to work. Full time assistance and paid vacation. Pay rate is \$9.50/hour.
Please bring your resume. Human Resources Representative will be available.
Tuesday Sept 11 10am to 2pm at
940 E Long Lake Rd Troy MI
Or send your resume to
STANDARD FEDERAL BANK
Human Resources Dept
2600 W Big Beaver Rd Troy MI 48064
Fax (248) 837-2759

BUYER
Northwest area medium sized company seeking a responsible experienced individual. Duties will include sourcing/procuring issues analyzing quotations negotiating prices & terms with suppliers. Responsible for annual market tests. Must have excellent verbal/written & interpersonal skills. Forward resume & salary requirements to
Attn: HR Department
12285 Dixie
Redford MI 48239
Fax 313 531 5243

CARPENTERS WANTED
Familiar with minimum 2 years experience. New construction and some remodeling.
734 328 0836 or 734 635 1606

CHEMIST
Leading analytical laboratory has an immediate full time opening in their GC (gas chromatography) department. Position requires high school diploma and some college chemistry. Experience in OSHA/NIOSH methods and computer applications is a plus. Will train the right candidate. Send resume in confidence to: Ms. C. Kapsanis Clayton Group Services Inc 22345 Roethel Drive Novi MI 48375
fax number (248) 344 2855 or email to ckapsanis@claytongrp.com
No phone calls please EOE/AEE/M/F/H/V

CHILD CARE PROFESSIONALS NEEDED
Learn While You Earn! The Learning Tree offers employees an Education reimbursement program and on site training. Along with 401K Retirement Plan, Medical/Dental Benefits, Paid Vacation/Holidays and Personal Days. Raise reviews by yearly Bonus Program.
Call 734 525 5767 or apply in person

LEAD CHILDCARE PROVIDERS
Needed for our All Day Pre school and School Age programs. Applicants must have completed CDA credential or 12 semester hours of credit in Early Childhood \$8.45-\$9.65/hr
SUBSTITUTES/CHILDCARE PROVIDERS
Needed for Preschool and School age Programs. Applicants must be at least 18 yrs of age with high school diploma or GED. Experience preferred but will train \$6.15-\$7.13/hr
Qualified applicants should apply in person at the Dearborn Public Schools Human Resources Department 18700 Audette Dearborn (313) 730 0580 EOE/AEE

CLEANING FLOATER
30-40 hrs/wk. Eves. Must be reliable \$9/hr Farmington area. Call 248-615-3554

CLEANING OFFICES
Novi Farmington & Southfield 2 1/2+ hrs eves. Mon-Fri 248 615 3554

CHEMIST
Leading analytical laboratory has an immediate full time opening in their GC (gas chromatography) department. Position requires high school diploma and some college chemistry. Experience in OSHA/NIOSH methods and computer applications is a plus. Will train the right candidate. Send resume in confidence to: Ms. C. Kapsanis Clayton Group Services Inc 22345 Roethel Drive Novi MI 48375
fax number (248) 344 2855 or email to ckapsanis@claytongrp.com
No phone calls please EOE/AEE/M/F/H/V

CHILD CARE ASSISTANT
Needed for Christian learning center in Plymouth. Full & part time positions. Flexible hrs. Benefits available. Call Dawn at (734) 455 3196

500 Help Wanted General

TELLERS
STANDARD FEDERAL BANK member ABN AMRO Group has immediate openings for full time and part time Tellers. Light typing, good math aptitude and customer service skills required. Must also have one year of cashier experience. We provide the training you'll need helping you learn valuable business skills that can lead to advancement.
In addition to learning valuable job skills, you'll also receive competitive pay and an attractive benefits package. Part time employees working 20 or more hours per week are eligible for medical coverage paid holidays on days regularly scheduled to work. Full time assistance and paid vacation. Pay rate is \$9.50/hour.
Please bring your resume. Human Resources Representative will be available.
Tuesday Sept 11 10am to 2pm at
940 E Long Lake Rd Troy MI
Or send your resume to
STANDARD FEDERAL BANK
Human Resources Dept
2600 W Big Beaver Rd Troy MI 48064
Fax (248) 837-2759

BUYER
Northwest area medium sized company seeking a responsible experienced individual. Duties will include sourcing/procuring issues analyzing quotations negotiating prices & terms with suppliers. Responsible for annual market tests. Must have excellent verbal/written & interpersonal skills. Forward resume & salary requirements to
Attn: HR Department
12285 Dixie
Redford MI 48239
Fax 313 531 5243

CARPENTERS WANTED
Familiar with minimum 2 years experience. New construction and some remodeling.
734 328 0836 or 734 635 1606

CHEMIST
Leading analytical laboratory has an immediate full time opening in their GC (gas chromatography) department. Position requires high school diploma and some college chemistry. Experience in OSHA/NIOSH methods and computer applications is a plus. Will train the right candidate. Send resume in confidence to: Ms. C. Kapsanis Clayton Group Services Inc 22345 Roethel Drive Novi MI 48375
fax number (248) 344 2855 or email to ckapsanis@claytongrp.com
No phone calls please EOE/AEE/M/F/H/V

CHILD CARE PROFESSIONALS NEEDED
Learn While You Earn! The Learning Tree offers employees an Education reimbursement program and on site training. Along with 401K Retirement Plan, Medical/Dental Benefits, Paid Vacation/Holidays and Personal Days. Raise reviews by yearly Bonus Program.
Call 734 525 5767 or apply in person

LEAD CHILDCARE PROVIDERS
Needed for our All Day Pre school and School Age programs. Applicants must have completed CDA credential or 12 semester hours of credit in Early Childhood \$8.45-\$9.65/hr
SUBSTITUTES/CHILDCARE PROVIDERS
Needed for Preschool and School age Programs. Applicants must be at least 18 yrs of age with high school diploma or GED. Experience preferred but will train \$6.15-\$7.13/hr
Qualified applicants should apply in person at the Dearborn Public Schools Human Resources Department 18700 Audette Dearborn (313) 730 0580 EOE/AEE

CLEANING FLOATER
30-40 hrs/wk. Eves. Must be reliable \$9/hr Farmington area. Call 248-615-3554

CLEANING OFFICES
Novi Farmington & Southfield 2 1/2+ hrs eves. Mon-Fri 248 615 3554

CHEMIST
Leading analytical laboratory has an immediate full time opening in their GC (gas chromatography) department. Position requires high school diploma and some college chemistry. Experience in OSHA/NIOSH methods and computer applications is a plus. Will train the right candidate. Send resume in confidence to: Ms. C. Kapsanis Clayton Group Services Inc 22345 Roethel Drive Novi MI 48375
fax number (248) 344 2855 or email to ckapsanis@claytongrp.com
No phone calls please EOE/AEE/M/F/H/V

CHILD CARE ASSISTANT
Needed for Christian learning center in Plymouth. Full & part time positions. Flexible hrs. Benefits available. Call Dawn at (734) 455 3196

500 Help Wanted General

TELLERS
STANDARD FEDERAL BANK member ABN AMRO Group has immediate openings for full time and part time Tellers. Light typing, good math aptitude and customer service skills required. Must also have one year of cashier experience. We provide the training you'll need helping you learn valuable business skills that can lead to advancement.
In addition to learning valuable job skills, you'll also receive competitive pay and an attractive benefits package. Part time employees working 20 or more hours per week are eligible for medical coverage paid holidays on days regularly scheduled to work. Full time assistance and paid vacation. Pay rate is \$9.50/hour.
Please bring your resume. Human Resources Representative will be available.
Tuesday Sept 11 10am to 2pm at
940 E Long Lake Rd Troy MI
Or send your resume to
STANDARD FEDERAL BANK
Human Resources Dept
2600 W Big Beaver Rd Troy MI 48064
Fax (248) 837-2759

BUYER
Northwest area medium sized company seeking a responsible experienced individual. Duties will include sourcing/procuring issues analyzing quotations negotiating prices & terms with suppliers. Responsible for annual market tests. Must have excellent verbal/written & interpersonal skills. Forward resume & salary requirements to
Attn: HR Department
12285 Dixie
Redford MI 48239
Fax 313 531 5243

CARPENTERS WANTED
Familiar with minimum 2 years experience. New construction and some remodeling.
734 328 0836 or 734 635 1606

CHEMIST
Leading analytical laboratory has an immediate full time opening in their GC (gas chromatography) department. Position requires high school diploma and some college chemistry. Experience in OSHA/NIOSH methods and computer applications is a plus. Will train the right candidate. Send resume in confidence to: Ms. C. Kapsanis Clayton Group Services Inc 22345 Roethel Drive Novi MI 48375
fax number (248) 344 2855 or email to ckapsanis@claytongrp.com
No phone calls please EOE/AEE/M/F/H/V

CHILD CARE PROFESSIONALS NEEDED
Learn While You Earn! The Learning Tree offers employees an Education reimbursement program and on site

500 Help Wanted General

COLLECTIONS

Asset Acceptance Corp has immediate openings in our Warren office for motivated collectors. Experience preferred but not necessary if your background is sales customer service or telemarketing...

In addition to a competitive salary and uncapped monthly bonus our outstanding benefits package includes:

- Paid medical/dental/vision insurance
• 3 weeks paid vacation
• Paid holiday and personal days
• Paid training
• 401K

Please mail or fax your resume to Asset Acceptance Corp

Warren MI 48090 Fax (810) 446-7825 or 446-7839 Phone (810) 939-9800 ext 8711 or 8729 Email hr@assetacceptance.com

Controller

Controller position for industry leader in Commercial Real Estate. Minimum requirements include 4 year Degree and previous real estate experience.

Submit resume to Box #1245 Observer & Eccentric Newspapers 36251 Schoolcraft Rd Livonia MI 48150

Counter Help

For dry cleaners. Good working conditions. Non smoker. Call (734) 421 9090

COUNTER HELP

Great jobs for Moms. Apply in person at The Bagel Station 29606 Wixom Rd Wixom (248) 980 9711

COUNTER OFFICE Clerks

Full or part time. Will train. For stores in your area. For interview Start now! 313 537 8050

COURIER / MESSENGER

Williams Mullen Clark & Dobbs is hiring a courier in Detroit. Law firm seeks part time or full time messenger. Position involves picking up and delivering documents...

Call for immediate interview. Start now! 313 537 8050

CPA

An Arbor CPA firm desires experienced CPA. Health insurance 401k cafeteria plan up to 8 weeks paid time off. Growth opportunity. Send resume to Loy Hartley & Co 2211 Jackson Rd Ann Arbor MI 48103

CUSTODIAL HELP

South field banquet hall. Permanent full time. Two shifts. Full benefits. Overtime. 248 901 4313

DISPATCHER

Ground transportation co in Livonia has immediate full & part time positions available for organized individuals able to work in a fast paced environment. Fax resume to 734-542-8911 or call 734-542-7994

CUSTOMER RELATIONS

Image oriented Southfield office seeks outgoing computer literate person for full/part time. Advising clients answering phones and assisting in office work in a fun environment. MUST be friendly, enthusiastic and a team player. Please contact Ms Jones 248 352 0058

CUSTOMER SERVICE REPRESENTATIVE

Part time Mon-Fri 1:15 PM. We are a national distributor of award winning greeting cards and stationary items. We require your upbeat manner and professionalism to keep the wheels of our busy company turning. Office or sales experience required. Good computer skills preferred. Please send resume to Santoro Graphics P.O. Box 80526 Rochester MI 48308

500 Help Wanted General

Customer Assistance

\$9-\$13/HR (Average Earnings)

American Blind & Wallpaper Factory is currently hiring Inbound Telesales Representatives in Plymouth. Immediate permanent positions available for evening shifts. No calling. Our customers call us!

We Offer: *Wage Guarantee *Paid Training *Advancement Opportunities *Business Casual Dress

Call Today! 1-800-346-0599 Mon-Fri 8am-5pm Thurs until 7pm

American Blind and Wallpaper Factory decoratortoday.com

CUSTOMER SERVICE REPRESENTATIVE

NOVI Growing Medical/Legal business seeks a pleasant professional & outgoing person with developed computer/telephone skills. Customer Service or Medical Billing experience a plus. Full time position with room for advancement. Send resume and salary requirements to Box #1190 Observer & Eccentric Newspapers 36251 Schoolcraft Rd Livonia MI 48150

CUSTOMER SERVICE

Hagopian World of Rugs in Novi is looking for a full time individual to staff their rug cleaning drop off counter. Must have good math aptitude, friendly manner and sales ability. Some heavy lifting required. Hourly rate plus commission potential to \$25K+. Advancement potential. Send resume to 401K. Send resume by fax or email to HAGOPIAN/Ed 43223 Twelve Mile Hwy Novi MI 48377 Fax 248-449 1555 Email Hagopian@aol.com Drug Free workplace

CUSTOMER SERVICE MANAGER

Make a difference with pets and people. Join our team managing this large 23 doctor veterinary referral and emergency hospital in Southfield. We seek an experienced manager with customer service and personnel skills as our second shift (afternoons) manager to lead our reception and emergency services area. Share management duties with our three other managers. Hospitality, medical or veterinary experience helpful. Please fax or email your resume to Melissa Burns Human Resources Coordinator Fax 248 354 6586 Email jobs@mchvet.com

DIRECT CARE

Full/part time support positions in small group homes and apartments serving adults with developmental disabilities in Downriver and Western Wayne County communities. Entry level management position also available. Competitive wage & benefits training provided. Call 734-728-4382

Apply at JARCO 30301 Northwestern Hwy Farmington Hills MI 48334 or fax resume to (248) 538 6615

DIRECT CARE

Part-time Will train. Westland area. Call Laurie 734 595 3253

DIRECT CARE STAFF

Dependable individuals for full & part time positions in Livonia with Everest Inc. Eligible for 100% company paid benefits in 30 days. Certification through CLS preferred but will train. Call for immediate interview. Mon-Fri 10am-2pm 734 524 1361

DIRECT CARE STAFF

Will train qualified persons to work in the care giving field \$7.70 \$8.20 hourly wage with excellent benefits. Call program listed below

LIVONIA 734 522 6428 734 591 9239 248 478-3855 248 474 6996 734 591 0272

REDFORD 313 535 8605 313 255 7639

WESTLAND 734 457 3347 734 513 5347

ROMULUS 313 255 8295 734 942 1959

WAYNE 734 721-9419

Flexible Part Time Positions \$9 Per Hour For further information call 313 255 8295

DIRECT CARE STAFF

Needed for group homes. Fully trained \$9/hr. Untrained \$7.50/hr. Call 734 422-4012 734 397 9556 248 471 5013

DIRECT CARE WORKERS

Full or part time positions in Wayne County independent sites. 1 year exp required. \$8.62 to \$9/hr to start. DMH trained preferred. Call HR 248 985 1203 EOE

DISPATCHER

FANTASTIC opportunity to join a small company moving to the Livonia area. We offer exciting and challenging opportunities. Competitive wages and benefits. Strong interpersonal skills a must. Full time mid day (11-7:30) shift including week ends. Training provided. Call (313) 396-5880

DELIVERY PERSON

\$10 per hour part time. From Home area to Howland. H&R (Livonia & Brighton) 810 225 1700 (No Faxes)

DELIVERY/SET UP

PART/TIME FULL TIME for family owned party rental co. 734 364-9591

500 Help Wanted General

DELIVERY/SERVICE

Full time union pay. Must be able to lift heavy equipment. Apply in person 42149 Ford Rd or Call (734)844 8422

DETAILER SUPERVISOR

Experienced with computer knowledge. Good pay good benefits. See Jim Davis BILLBROWN FORD 32222 Plymouth Rd Livonia No phone calls please

DEVELOPMENT COORDINATOR

Assist in gathering information tracking and submission of crucial documents pertaining to land development. Perform general daily administrative duties. Organization and communication skills a must. Microsoft Office proficient. Fax resume to Kelly at (248) 642 0199 or email Kkeaton@landonco.companies.com

DIESEL MECHANICS

Certified Light Duty \$24/hour to start. Call Gearheads 800 298-9938

DIRECT SUPPORT

Work for one of Metro Detroit's 101 Best and Brightest Companies!! Our agency provides the highest quality of care to people with developmental disabilities. Full time part time openings in our Oakland County group homes waiting pay that CAN be beat \$9.50/hr trained (w/great benefits for full-time) Apply at JARCO 30301 Northwestern Hwy Farmington Hills MI 48334 or fax resume to (248) 538 6615

DIRECT CARE

Full/part time support positions in small group homes and apartments serving adults with developmental disabilities in Downriver and Western Wayne County communities. Entry level management position also available. Competitive wage & benefits training provided. Call 734-728-4382

Apply at JARCO 30301 Northwestern Hwy Farmington Hills MI 48334 or fax resume to (248) 538 6615

DIRECT CARE

Part-time Will train. Westland area. Call Laurie 734 595 3253

DIRECT CARE STAFF

Dependable individuals for full & part time positions in Livonia with Everest Inc. Eligible for 100% company paid benefits in 30 days. Certification through CLS preferred but will train. Call for immediate interview. Mon-Fri 10am-2pm 734 524 1361

DIRECT CARE STAFF

Will train qualified persons to work in the care giving field \$7.70 \$8.20 hourly wage with excellent benefits. Call program listed below

LIVONIA 734 522 6428 734 591 9239 248 478-3855 248 474 6996 734 591 0272

REDFORD 313 535 8605 313 255 7639

WESTLAND 734 457 3347 734 513 5347

ROMULUS 313 255 8295 734 942 1959

WAYNE 734 721-9419

Flexible Part Time Positions \$9 Per Hour For further information call 313 255 8295

DIRECT CARE STAFF

Needed for group homes. Fully trained \$9/hr. Untrained \$7.50/hr. Call 734 422-4012 734 397 9556 248 471 5013

DIRECT CARE WORKERS

Full or part time positions in Wayne County independent sites. 1 year exp required. \$8.62 to \$9/hr to start. DMH trained preferred. Call HR 248 985 1203 EOE

DISPATCHER

FANTASTIC opportunity to join a small company moving to the Livonia area. We offer exciting and challenging opportunities. Competitive wages and benefits. Strong interpersonal skills a must. Full time mid day (11-7:30) shift including week ends. Training provided. Call (313) 396-5880

DELIVERY PERSON

\$10 per hour part time. From Home area to Howland. H&R (Livonia & Brighton) 810 225 1700 (No Faxes)

DELIVERY/SET UP

PART/TIME FULL TIME for family owned party rental co. 734 364-9591

500 Help Wanted General

DOOR MANUFACTURER

in Redford needs production worker. Mon-Thurs 5am-3:30. Some benefits \$9.30 to \$10.50. Drug screening (313) 531 7180

DRIVERS

Gravel Train & Semi Dump Immediate openings Full time CDL needed. Experienced only. Call 734 455 4036 9am-5pm

CLASS A DRIVER

Leading turf and ornamental distributor is looking for a Class A CDL driver. Hazmat Endorsement needed but not necessary to start. Benefits include health dental 401k and company paid pension plan. Call Mon-Fri 9am-2pm 248 474 7474

GRAVEL TRAIN DRIVER

needed full time. Experienced only. Call 734-455 2119

DRIVER

Are you looking for a better work environment? Join our Northville construction supply co as a service driver/warehouse Great pay w/O.T. & fringes. If you have a clean driving record call Jeff or Tony at (248) 347 3524

DRIVER

Excellent for high school grad. Must have good driving record & be familiar with metro Detroit. CDL license helpful but not required. Full time. Apply in person Mon-Fri 10am-4pm and send resume to Dept. of Prof. Supply 38170 N Executive Dr Westland MI 48185 Or fax resume 734 728 0799 Attn: Kevin or Rob

DRIVER / Over The Road

1 year experience. Good motor vehicle record. Call 889 271 8865 Or 810 845 0968

DRIVER/PORTER

Good driving record a must \$8/hr. Call Mark 734-721-4030

DRIVER

Regional run \$725 \$900 per week. High weekly miles no weekends. Assigned conventional tractor. Paid holidays vacation & insurance. Toll Free 1 877 932 6300

Awesome Opportunities!

CDL, Class A License Home Weekends/Home Nights! No Experience Necessary! \$600.00 to \$900.00 Per Week! Tuition Reimbursement For Qualified Applicants

Home Weekends/Home Nights! No Experience Necessary! \$600.00 to \$900.00 Per Week! Tuition Reimbursement For Qualified Applicants

Nu Way Truck Driver Training Centers 7 Days A Week Pontiac MI CALL TODAY 1 800 736 1912

Redford Union Schools BUS DRIVERS

CDL B/C required. Will train. Excellent driving record required. Competitive wages/benefits. Qualified applicants should apply in person at Human Resources Dept. Redford Union Schools 18499 Beach Daly Rd Redford MI 48240 EOE

DRIVER SEMI OTR

Exp/for needed home every week nights. Class A CDL required. (810) 231 3042

DRIVERS

ERB LUMBER INC (a division of Carolina Holdings Inc.) has immediate openings for Drivers At the Livonia location. We offer attractive salaries and outstanding benefits including profit sharing 401k with company match and vacation/medical/dental and life insurance. Apply in person Mon-Fri or send resume to Erb Lumber Inc. atn: Management 12800 Stark Rd Livonia MI 48150 fax resume to 734-421 1765 EOE Drug Free Work Environment

DRIVERS TOW TRUCK

\$1000 Signing Bonus! Full time position with 401(k) medical dental benefits available. Westland Car Care Towing 6375 Hix Road Westland MI 48185

DRIVER

Tractor Trailer CDL A Competitive salary & benefits. Steel & building supply deliveries in the tri county area. Apply at SMEDESON STEEL 12584 Inkster Rd Redford MI 48239

Driver/Warehouse Assistant

CDL/Chauffeurs license required. Detroit area. Fax resume 734-458-4158

Fashion Show Participants

Men/women all sizes work shops paid training. Start immediately 248 262 6801

500 Help Wanted General

DRIVER

With Welder Experience Needed to perform jobs in the field. Should have a clean driving record to drive company truck. Benefits Apply at Smede Son Steel & Supply 12584 Inkster Rd Redford MI 48239

EARN \$25 000 \$50 000/yr

Medical Insurance Billing Assistance Needed Immediately! Use your Home Computer get FREE Website & FREE LONG DISTANCE 1 800 291 4683 ext 407

eePulse Inc

A growing application service provider located in Ann Arbor is looking for qualified candidates to fill the following positions:

- Account Executive/Project Manager
• Data Processor
• Executive Assistant for CEO
• Receptionist
• Bookkeeper

Candidates must possess a minimum of 5 years experience and must also be energized motivated and team oriented. If interested please send resume and salary requirements to Careers at eePulse Inc 905 W Eisenhower Circle Suite 110 Ann Arbor MI 48103 Or e-mail resume to careers@eepulse.com

MYCRONA INC

manufactures high precision inspection equipment for quality control in the automotive aerospace medical and electronics industries. We are seeking an individual for the position of Electrical/Hardware Technician with drive experience and the willingness to learn. Travel is required. Fax your resume to 734 453 4076 or email us at quality@mycrona.com Attn: David Cooper

ELECTRICAL ASSEMBLY

\$10 Ability to read schematics & soldering a must. STAFFING SERVICES OF MICHIGAN LTD (734) 542 0500

JOURNEYMAN ELECTRICIAN

Licensed Immediate hire Benefits (248) 855 3505

JOURNEYMAN ELECTRICIAN

OR SEASONED APPRENTICE With commercial/industrial experience for electrical contractor in metro Detroit area. Top wages & benefits. Call (313) 255 3571

Forge INDUSTRIAL STAFFING

ENTRY LEVEL INDUSTRIAL POSITIONS ALL SHIFTS AVAILABLE

- Packaging
• Assembly
• Mach. or Operation
• Warehouse mg.
• Production Line
• General Labor

Most positions are Temporary to Full Time 31835 Eight Mile Road Livonia MI 48152 Applications accepted Monday-Thursday 5am to 12 midnight Friday 5am-6pm NO APPOINTMENT NECESSARY

EOE 12 PEOPLE NEEDED

START NOW!

Due to company expansion we have openings in all departments Livonia area. Opportunity to earn \$20.00 Month. No experience necessary. Rapid advancement. For interview call Mon 10 6 734 525 5556

EXECUTIVE CHAUFFEUR

Excellent earning potential. Please leave message (248) 478 3189

EXPERIENCED PLUMBER

Residential & Commercial. Wages Benefits & IRA negotiable. Call Ron (248) 640 5623

FABRICATOR

wanted for commercial glass contractor. No phone calls please. Apply at Exterior Walls 19720 Gerald Northville

FASHION SHOW PARTICIPANTS

Men/women all sizes work shops paid training. Start immediately 248 262 6801

Fashion Show Participants

Men/women workshop. Paid training. Start immediately 248 262 6801

500 Help Wanted General

Fall Openings

www.eamparttime.com \$14 05 base+appt Full/Part time Customer Sales/service. Conditions exist must be 18+. Call Mon-Fri 9-5pm (734) 522-5480

FIREPLACE INSTALLATION

*Earn up to \$1000/wk *New construction work *We will train *Truck or van needed *248 448 8334 After 2pm

FLORAL DESIGNER

Full or part time. Experienced. Good wage and benefits. Downtown Rochester. Jim 248 651 4510

FOCUS ON YOUR CAREER

Do you want to work in a fun fast paced environment within a company that cares? Consider an opportunity with D O C Optics. We seek energetic fashion minded sales associates and customer service coordinators. We offer great benefits/salary pay. Commissioned. Call 1 800 289 3937 ext 218 fax resume to 248 353 4171 or email to careers@dcoptics.com

FREIGHT HANDLER/LUMPER

3 shifts full or part time available. Livonia Plymouth Detroit area. \$300 to \$500/wk. Pays by the load. Benefit package available. Drug test. Fax letter of contact to 734 384 5240

FURNACE & AIR COND

Experienced installer and/or service person. Excellent working conditions & wages. Family Heating Cooling & Electrical (734) 422 8080

MACHINE TECHNICIANS

CSR

CSR has immediate openings in Farmington Hills area looking for Concrete Finishers & Asphalt Laborers. Some exp necessary. Good pay & benefits. 248 476 5122

GENERAL HELPER

General helpers needed to handle light maintenance apartment prep and grounds. Call Mon-Fri 9am-5pm EOE 248 648 9800 Detroit 313 341 2468 Dearborn Hgts 313 271 4649 Westland 734 425 0052

GENERAL HELP

For medium sized Westland Apt Community. Hard worker and willing to perform variety of tasks. (734) 722 4700

GENERAL LABORER

Builder seeks full time general laborer for new residential subdivisions. Must have own transportation & willingness to work \$2 11/hr. For an interview call Mark at (248) 888 5050

GENERAL LABOR

Office seating manufacturer seeking full time employees for Mon-Fri day shift 7am-3:30pm. Full benefits & 401(k). No experience necessary. Call 734 722 8200

GENERAL LABOR

Plastic Injection Molding company in Canton seeks several dependable people to fill entry level positions on 2 shifts. Starting pay \$9 per hour.

EMPLOYMENT

Your classified ad is automatically posted on the internet! Visit us today

observer-eccentric.com

500 Help Wanted General

LAWN SERVICE Landscape & Sprinkler Foreman & Laborers wanted Competitive wages plus bonuses paid to foreman for running crews Southfield based on 248 354 3213 or 248 626 0283

LEASING CONSULTANTS Part time evenings every other weekend for Canton apartment community 734 397 1080

LEASING POSITION for Apartment Community in Southfield Full time Experience preferred Benefits available Call Paragon Properties ask for Richard 248 946 9500 x 329

LIFEGUARDS

Canton Township is accepting applications for Lifeguards Must be available to work Friday evenings and weekends \$6.59 50/hr Training provided Applications available at the Township Administration Building Personnel Division 1150 S7 Canton Center Road Canton MI 48198 An application on form is also available on the Canton Township website at www.cantonmi.org The Charter Township of Canton does not discriminate on the basis of race color national origin sex religion age or disability in employment or the provision of services An Equal Opportunity Employer

LIGHT ASSEMBLY and SIT DOWN PRODUCTION

Northville Mfg Co seeking full and part time employees No exp necessary Complete benefit package Profit sharing 401k medical dental optical and life Educational Assistance Program offered Apply in person @ Belanger Inc 22700 Heip Nov MI or contact Army Peston Human Resource Manager @ 248 348 9038

LOAN OFFICERS

Experienced for Southfield Mortgage Co Able to self generate leads Telecommute or office positions Call 248 395 2808 Fax resume to 248 395 2813 or E-mail advantage208@cs.com

LOOKING FOR outgoing positive Front Counter/Customer Service position in a fun health club in Northville Competitive benefits package Will train right person Flexible evening & weekend hours Call Chris K (248) 449 7634

LOOKING FORWARD TO WORK FROM HOME? Sit Home! Set your own hours Set your own income TAKE CONTROL BeBossFree.com

LUBE TECHNICIAN

Joe Pan Chevrolet has an immediate opening for an experienced full time LUBE TECHNICIAN Excellent benefits and pay plan Please apply in person to Ron Griffin Service Manager Joe Pan Chevrolet Medium Duty Truck Center 28111 Telegraph Southfield

MACH NE OPERATORS & WELDERS

Immediate openings for 1st & second shift Mechanic capable of repair work vs wages benefits in a great work environment US 23 96 ocat on Please send ep Box 45764 c/o The Brighton Ave 202 W Main Brighton MI 48115

MACHINE OPERATOR

Full time for specialty machines Ability to read measur ng equipment a must Train ng given Apply 8210 Ronda Drive Canton MI 734-453-1199

MACHINE OPERATORS

We offer an excellent benefit package an conditioned facility overtime and an opportunity for advancement Day and afternoon shifts available Wages commensurate with experience The following positions are available

- CNC Machinists
Ded Tool Grinder
General Labor
ing Grinder
Surface Grinders
Wre EDM
Fax Call or Apply in Person
Moeller Manufacturing
43938 Plymouth Oaks Bl
Plymouth MI 48170
Tel (734) 416 0000
Fax (734) 416 2200
EOE

MACHINE TECHNICIAN

Process Improvement is only one of the exciting challenges facing our team members! We have an extensive 2 year training program for individuals with skills in the following

- Mechanical
Automation
Team Oriented
Quality Conscious
Preventative Maintenance
We have an excellent benefit & pay structure clean environment and team work second to none If you have what it takes then send a brief work history with salary requirements or apply in person to

Human Resources MT Plastpak Packaging Inc 1351 Hix Westland MI 48185 e-mail career@plastpak.com EOE

HOME SERVICES

Clean cut experienced in several trades own vehicle & tools Full time w/ benefits

MAINTENANCE DIRECTOR/ENGINEER Full time benefits Immediate opening Boiler Operator license required Farmington YMCA Call Rick Durfee 248 553 4020

MAINTENANCE

Experienced for medium size Westland Apt. Community Must have own tools and good references (734) 722 4700

500 Help Wanted General

Maintenance Assistant

First Mercury Financial Corporation is seeking a candidate to assist the Facilities Manager with maintenance duties for 16 000 sq ft commercial building 13 yrs exp in a commercial facility preferred This is a full time position with excellent benefits including 401K Submit resume to HR Dept Job Code 225 01A P O Box 5096 Southfield MI 48086 Fax 248 358 2004 E-mail firstmercuryjobs@yahoo.com EOE

MAINTENANCE

Farmington Hills area luxury apartment community currently has positions available for experienced Redec or Turn Key technicians Salary plus a free apartment for qualified personnel Life Health dental and 401K also provided

Please call (248) 426 8170 or fax resume to (248) 473-8555

MAINTENANCE

For general maintenance & landscaping at mid size apartment community in Plymouth Full time dependable person Call 734 455 3880

MAINTENANCE/HANDY PERSON

Skilled in carpentry elec tric plumbing Truck & tools required Excellent pay benefits 734 762 5006

MAINTENANCE

Mature responsible person to perform required repairs at luxury suburban apartment community in Canton Experienced in plumbing heating electrical and air conditioning This is not a live in position including 401(k) program medical and disability insurance Call 9am 11am Mon Fri (248) 352 3800 x1236

MAINTENANCE

Mid size apartment community requires your maintenance and landscaping skills Competitive salary and benefits including pension CALL (734) 729 5080

MAINTENANCE

Needed for Woodward Apartments Must have experience in all aspects of maintenance 401k & paid holidays offered No faxed resumes please Apply in person 6737 N Wayne Rd Westland 734 326 8270

MAINTENANCE PERSON

High volume theater is seeking handy person to maintain building Multiple tasks including electrical and plumbing equipment repair Livonia area (734)542 3191

MAINTENANCE PERSON

needed flexible hours for apart ment community located in Southfield Requires expertise in all aspects of maintenance including certification in HVAC Fax resume (248) 358 3779

MAINTENANCE TECH

Mendian Automotive Systems Dearborn Operation is looking for an experienced technician to assist our maintenance

Qualifications include

- Minimum of 3 years experience in trouble shooting injection molding operation
Ability to read electric and hydraulic schematics and blueprints
Experience with preventive maintenance
Dependable self-starter flexible to work any shift

We offer a competitive salary and benefits

Apply 5433 Miller Road Dearborn MI 48126 Call (313)584-6200 or Fax resume to (313)584-9653

MAINTENANCE TECHNICIAN

A large apartment community in Troy is looking for a highly motivated maintenance tech Expert preferred but not necessary Pay based on experience Great benefit package Fax resume to 248 689 7326 or call 248 689 5070

MAINTENANCE TECH

Southfield Property Management company has full time openings for various locations Must have 2 years experience in heating electrical plumbing & AC certified Benefits EOE For central division fax resume to 248 352 2837 or call Beverly Hills 248 646 9880 Southfield 248 653 9050 Waterford 248 681 9880

MAINTENANCE TECHNICIAN

Excellent opportunity with a fast pace growing finishing company in the Detroit area Candidates must be mechanically inclined with AC certification Benefits EOE For central division fax resume to 248 352 2837 or call Beverly Hills 248 646 9880 Southfield 248 653 9050 Waterford 248 681 9880

MAINTENANCE TECH

Southfield Property Management company has full time openings for various locations Must have 2 years experience in heating electrical plumbing & AC certified Benefits EOE For central division fax resume to 248 352 2837 or call Beverly Hills 248 646 9880 Southfield 248 653 9050 Waterford 248 681 9880

OFFICE/ADMINISTRATIVE HOUSE

Denmark is seeking a leading Michigan furniture retailer is looking for an Office/Administrative position at our Livonia store Must have good clerical skills phone skills typing filing data entry Customer relation skills important Full time with comprehensive benefit package including paid health & life insurance vacation 401K and profit sharing Please send or fax resume to House of Denmark 35555 Plymouth Rd Livonia MI 48150 Fax (734) 425 9230

OFFICE CLEANING

Westland Mon thru Fri evns 2 1/2 hrs/night \$125/wkmark EOE Experienced only 810 227 1624

500 Help Wanted General

PLANT MANAGER

Troy based 20 person shop seeks mechanical & organized person Fax to 248 260-1013

Assistant Manager/Bookkeeper

Needed for large luxury apartment community in Southfield Must be energetic self starter people person and a team player with great customer service Competitive hourly rate plus commission and wonderful benefits Please fax your resume to SUTTON PLACE APTS (248) 352 9502

AFTERNOON SHIFT MANAGER

Northwest area medium sized company is seeking a responsible individual with 10 yrs supervisory exp Familiar with computerized systems Duties include insuring that inventories are maintained both system wise & physically in the facility Troubleshooting & resolution of inventory inaccuracies Account able for meeting production targets & continuous operational improvements Will be responsible for all departments during verbal written & interpersonal skills Forward resume including salary requirements Attn HR Department 12285 Dixie Street Redford MI 48239 Fax 313 531 5243

MANAGER Tuxedo rental

Good pay & benefits Must be dependable & courteous Will train 734 525 0020

MANUFACTURING

Erb Lumber Inc (a division of) is seeking individuals to hire laborers Work on a production line assembling wall units and various other products/procedures help with daily manufacturing activities in shop work with cover of tools Requirements needed lift and carry 50+ pounds and basic math skills Excellent benefit and compensation package includes 401k with cost match medical dental vision paid vacation/holidays tuition reimbursement Apply in person to 11970 Farmington Road Livonia MI 48150 or fax resume to 734-251-0390 Drug Free Environment EEO Employer

MASONRY ESTIMATOR

Large masonry company needs experienced estimator in Northwest area Fringes Fax resume to (248) 437 9752

MASTER PLUMBER

Qualifications Must have Jour neyman's Plumber's license (Reciprocal) specific knowledge of current plumbing codes experience in all phases of plumbing maintenance building alterations & construction to interpret prints sketches specifications & oral instructions Post ng closes September 18 2001 For information on applying call 734-235-2025 Wayne Westland Community Schools 36745 Marquette Westland MI 48185 EOE

FARMINGTON HILLS

landscaping company looking for experienced Equipment Mechanic Must be organized Good pay & benefits available 248-474 6167

TRAILER MECHANIC

Competitive wage 401(k) Medical benefits Call 8AM Noon 734 354-6680

FORKLIFT

Leading SE Michigan forklift dealership seeks exp d mechanics Excellent wage/benefit package Call 734-449-4455 GB Sales & Service Plymouth 734 455 5150

MECHANIC

Looking for a good honest and fair shop to work for Great team looking for 1 tech 4 day wk for base + commission 313-534-0808

MECHANIC (SMALL ENGINE)

\$8-\$18 per hr based on experience H&R income (Light) (810) 225 1700 (No Faxes)

MECHANICS

Southgate Tier One Supplier seeking experienced mechanic for instrumentation project 1st & 2nd shift Must have own tools Call (248) 449 9700 Fax (248) 449-4455

METER READERS

Immediate openings training available paid holidays & vacations Health insurance 401(k) plan Over time available Must have driver's license & reliable transportation EOE Call in Howell area (517) 545 9888

MORTGAGE PROCESSOR

Great opportunity for an experienced person in the Detroit area to join our team Pleasant working environment and salary commensurate with experience 401K and other benefits available Fax resume to 734 425-4834 Call 734 425-4820

Mortgage Underwriters

Oakland County \$35 55K depending on experience Must have DU & LP Some overtime Fax confidentially 734 524-0928 Email afisher@hirsrich.com

OFFICE/ADMINISTRATIVE HOUSE

Denmark is seeking a leading Michigan furniture retailer is looking for an Office/Administrative position at our Livonia store Must have good clerical skills phone skills typing filing data entry Customer relation skills important Full time with comprehensive benefit package including paid health & life insurance vacation 401K and profit sharing Please send or fax resume to House of Denmark 35555 Plymouth Rd Livonia MI 48150 Fax (734) 425 9230

PRINTING & GRAPHICS

Typesetters Graphic Designers and Creo Solter Brisque Opera tors Full time top pay plus benefits and bonus Resume to JPS Book 45525 Grand River Novi MI 48374 or email ajohnson@jpscorp.com

PRINTING

Need bindery help who have experience running saddlestich & trim machines folders cut ters Excellent wages & benefits Call Tom at 734 942 9020 Or fax resume 734 942 9020

500 Help Wanted General

OFFICE SOLUTIONS

Copier Technician Are you dependable self starting and trustworthy? Do you want to make more money with significant career opportunities? Call Image Business Solutions Your Minolta Connection toll free at (866)777 IMAGE Full benefits bonuses and car programs available Potential profit sharing depending on experience

Order/Production Processor

Responsibilities include processing working and releasing fragrance orders The ideal candidate will be detail oriented with strong organizational analytical and interpersonal skills Computer data entry experience a plus Plenty of overtime and WITH SALARY REQUIREMENTS

Sovereign Sales LLC

32000 Amnham Rd Livonia MI 48150 Fax 734-464 6514 EOE

Packers/Sorters(25+)

Novi Commerce areas \$8 50/hr High tech facility tons of perks raise in 90 days Plenty of overtime and opportunity for advancement Call 734 524 0000

PAINTER

Farmington Hills area luxury apartment community currently has a position available for an experienced House Painter Must have a free apartment for qualified personnel life health dental and 401k also provided Please call (248) 426 8170 or fax resume to (248) 473-8555

PAINTER

Full time position at apartment community Experience necessary Must have good transportation reliable Apply in person at Aldingbrook Apartments on Drake Road North of Maple Road in West Bloomfield

PAINTERS

Experienced 5 years or more for apartment repaints Others need not apply Transportation a plus (734) 941 7250

PAINTERS & HELPERS

Immediate Openings Must have own transportation (248) 685 0002

PAINTERS

Professional reliable Commercial/Industrial painters with 3 5 yrs experience Must have reliable transportation and small hand tools Great pay 40 hrs/wk Benefits & pension plan offered Call Melissa Mon Fri 9 am Mastercraft Coatings 1 800 390 6351

PAINTERS WANTED

Good pay Plenty of winter work Call 248 426 0665

PAINTER

15 yrs exp Must be knowl edgable in blue print reading & estimating commercial & residential jobs Pay commensurate with ability Benefits Call David 248 933-0796 or Marc 248 425 9154

PARTS MANAGER

Joe Panan Chevrolet is in need of an experienced Parts Manager We are looking for an energetic individual with great people skills PM degree & experience is required Great benefits 401K incentivized compensation and a GREAT TEAM to work with Apply in person to Asher Panan General Manager Joe Pan Chevrolet Medium Duty Truck Center 28111 Telegraph Southfield

PART-TIME MANAGER

Novi storage facility has immediate opening for assistant manager (8 hrs/wk) Strong customer service skills & work ethic required Call 248 855 9676 Ext 150

PEOPLE NEEDED NOW

Permanent Positions Start immediately Up to \$400/wk No exp needed Benefits available must be at least 18 Call (734) 525 5656 EOE

PHONE WORK

Earn an average of \$8-\$12/hr Full or part time (734) 737 8901

PLUMBERS

NOW hiring Journeyman & Apprentice Plumbers for residential & commercial projects We offer Competitive Wages Medical Dental Paid Holidays & Vacations We require dedication determination mechanical skills & the willingness to take applications accepted at 12022 Delta Dr Taylor MI 48180 or call (734) 946 8428

PLUMBER Some exp in plumbing or building trades Competitive wages/benefits include medical life 401(k) paid vacation holidays sick days Excellent growth opportunity for motivated individual Call Livonia MI 48150 734-981 8510

COMPUTER PRINT & MAIL INSERTER OPERATORS

Full & part time positions Rapidly growing company in Novi needs Computer Print and Mail Operators For Print Operator PC knowledge Xerox/Oce high volume printer experience helpful Salary Bonus knowledge helpful for Mail Inserter Operator Excellent wage & benefits Mail resume to Box #1253 Observer Newspapers 36251 Schoolcraft Rd Livonia MI 48150 FAX 248 926 9001

PRINTING & GRAPHICS

Typesetters Graphic Designers and Creo Solter Brisque Opera tors Full time top pay plus benefits and bonus Resume to JPS Book 45525 Grand River Novi MI 48374 or email ajohnson@jpscorp.com

PRINTING

Need bindery help who have experience running saddlestich & trim machines folders cut ters Excellent wages & benefits Call Tom at 734 942 9020 Or fax resume 734 942 9020

500 Help Wanted General

PRINTING PRESS OPERATORS

Two color experience preferred Aggressive Livonia printing company \$14/hr 2 weeks vacation 1 paid holiday insurance benefits retirement plan Join this involved owner & spirited team 248 442 4715

PRODUCTIONS HELP

Local manufacturing co looking for help to pack automotive parts Day shift \$9/hr to start Apply in person DETROIT MI 48390 Nov 4530 248 689 2330

PRODUCT PACKAGER

Needed at Canton based fragrance company Mon thru Fri 9 30 1 30pm \$7 50/hr 734 254 0043

PROGRAM ASSISTANT ADULT DAY SERVICES

Develop and implement program activities for seniors Assist with program schedules evaluations of care plans and development of a variety of activities direct daily inv activities Livonia location Base salary \$7 00 Send resume to Help Source Livonia Adult Day Services 11771 Newburg Rd Livonia MI 48150 or fax to (734)591 6763

HelpSource complies with the Michigan Civil Rights Act the Michigan Handicapped Civil Rights Law and is an equal opportunity employer

PROGRAM COORDINATOR (Therapeutic Recreation)

Canton Township is accepting applications for part time Program Coordinator (TR) Job duties include coordination and supervision of a variety of activities including the summer day camp Rate of pay \$9-\$12 per hr depending on qualifications and experience Applications available at the Canton Township Personnel Division 1150 Canton Center Road Canton MI 48188 An application form is also available on the Canton Township website at www.cantonmi.org Canton Township of Canton does not discriminate on the basis of race color national origin sex religion age or disability in employment or the provision of services An Equal Opportunity Employer

PROPERTY MANAGEMENT

Our company is looking to expand! Home Properties a Real Estate Investment Trust (REIT) and managing 23 apartment communities in Detroit is looking for Community Managers Maintenance Technicians and Leasing Consultant positions We are seeking take charge people with excellent track record and some experience If you have the winning attitude to join our team mail or fax your resume to Home Properties 26898 North western Hwy Ste 120 South field MI 48034 (248) 799 5497 Home Properties is an Equal Opportunity Employer

PROPERTY MANAGER

Immediate opening full time for Farmington Hills based manager to manage 26898 North western Hwy Ste 120 South field MI 48034 (248) 799 5497 Home Properties is an Equal Opportunity Employer

PR PROFESSIONAL

If you've got 5 or more years of PR experience can handle press releases including some relations and write both press releases and feature articles we need to talk! We are a medium sized agency with a fast growing PR group Fax your resume to (248)268 0545 Equal Opportunity Employer

RECEPTIONIST/CLERK FULL TIME

Primary responsibility is to answer all incoming calls respond to inquiries and handle clerical tasks such as filing and preparing invoices for mailing Requirements Professional Phone Skills Ability to work in fast paced environment Knowledge of filing system We offer 401K Benefits Vacat ion/Personal Days and Health Benefits

RECEPTIONIST

\$10 hr up + Benefits & Perks Bubbly Personality Computer literate and award winning in Beauty Industry Glamorous environment Farmington/Novi Area Terrific opportunity for advancement FEE PAID Employment Center Agency (248) 963 1636

REFRIGERATION TECH

Exp with good driving record & ability to lift 70 lbs required Excellent pay based on exp We offer full benefits 401K paid vacations & holidays Apply at Parks Maintenance 25137 Plymouth Rd Redford MI 48239

RESPONSIBLE INDIVIDUAL NEEDED

to supervise students during after school activities Contact Jerry Oermann Oxford Schools (248) 969 5015

CUSTODIAN

Part time will work Mon Fri from 7 00 am 10 00 am Paid holidays vacation accrual and friendly work environment Call Brent at 734 522 3700 ext 129

RETAIL MARKET

has a full time position available in our Salad/Deli Dept You must enjoy working with the public Previous experience helpful This position requires 7 30 p.m. and one day on the weekend Please apply in person to Joe S Produce 33152 W Seven Mile Livonia MI 48152 Or fax resume to (248) 477 2133

SALES/MGMT. TRAINEE

Leads Leads Leads! No cold calls Unlimited income Many earn \$1000 2000 per wk plus quarterly bonus Great room opportunity Curious? Wayne & Monroe area call Tom @ 313 277 5030 Oakland & Macomb area call Gary @ 248 269 8815 RA8217

Sales Rep Service Tech

New construction vinyl window manufacturer seeks Sales Rep & Service Tech Construction industry background required Fax resume to 248 634-8933

SCHOOL ADMISSION & RELATIONS

For school of Cosmetology in Royal Oak The Job

- Enrollment of students
Student relations & Federal financial administration
Some administrative work

Requirements are excellent human relation skills good computer skills college degree preferred Competitive salary and benefits excellent hours Fax resume to 248-548 4379 Or Email Pressleyschool@cs.com

SECURITY GUARD WANTED

500 Help Wanted General TRAVEL CONSULTANTS If you're friendly outgoing aggressive hardworking and a fast learner take advantage of our paid sales training and earn \$7.70 per hour plus \$100-\$300/wk commission selling vacations to qualified leads using our proven telephone sales techniques Dearborn 313 278-4100

TRUCK DRIVERS Semi and gravel train Hayes Trucking Inc Lew (248) 348 6005 ext 12

TRUCK DRIVERS WANTED-WILL TRAIN Must have chauffeurs license reliable transportation and know Tn county area Apply in person Mon-Fri 10-4 953 Manufacturers Dr Newburgh/Cherry Hill area Westland

VERTICAL LATHE OPERATOR Steel industries is currently looking for a Vertical Lathe Operator Ideal candidates will be aggressive self motivated individuals who will be trained in the steel forging trade Basic must ability to read a tape measure is REQUIRED Experience driving a hi lo helpful Steel industries Inc offers a competitive salary and benefits If interested apply in person at Steel Industries 12600 Beech Daily Road Redford south of I96 on the east side of the road No Telephone Calls

VETERINARY TECHNICIANS/RECEPTIONISTS For veterinary hospital in Farmington Hills We will train competitive salary and benefits Please call 248 471 3636

VOCAL MUSIC/MUSICAL THEATER TEACHER Teacher for magnet high school program for the arts (CAPA) Must be skilled at working with team of staff on the artistic/musical productions assisting in rehearsal with K 12 general programs Writing curriculum and communicating regularly and effectively Appropriate teacher certification 8 up to full time position Call 734 523 9177 for application Send resume to J Stephen Smith Assistant Superintendent of Human Resources at Livonia Public Schools 15125 Farmington Rd Livonia MI 48154 An Equal Opportunity Employer

WAREHOUSE Fast growing company in Wixom seeks dependable self motivated individuals Must fit 35 Excellent benefits Call Nancy (248) 380 8887

WAREHOUSE HELP Warehouse Order Pullers needed for afternoon shift Owens & Minor a Fortune 500 Medical Distributor is looking for quality help M-F 3pm to 11:30pm Full benefits great team environment and rewarding secure work awaits you if you are self motivated trainable & have a great positive attitude 45755 Fve Mile Road Plymouth (734) 354 5077

WAREHOUSE HoMedics a large supplier of personal care products is seeking warehouse personnel for our Commerce Township and Keego Harbor facilities Candidates must be punctual reliable and willing to work and manage multiple tasks in a dynamic environment while maintaining a consistent positive attitude Excellent benefits including 401(k) Send or fax resume/salary requirements to HoMedics Inc Attn Human Resources 3000 Pontiac Trail Commerce Twp MI 48390 Fax (248) 863 3119

WAREHOUSE Virginia Tile Co has full time open position in Farmington Hills Must have 2-3 years warehouse experience and his profit sharing & 401K Call HR Manager 248 476-7850 x2284 or fax resume to 248-476-4522

WAREHOUSE \$9.50HR Temp to Perm ARBOR TEMPS Brenda @ 734 459 1186

\$2000 (PER MONTH OPPORTUNITY) Now Hiring Full Time Company has openings Must be able to start immediately No experience necessary Complete Company training Must have high school diploma or equivalent and dependable transportation Call Monday only from 11am-6pm 734-525 5656 EOE

501 Computer/Info Systems Computer Support/Network Administration Maintain and administer W2000 server support systems and hardware troubleshoot applications and hardware enhance and maintain databases Create system to track assets solve ware configurations and problems Familiarity with Win98 WinNT Access Outlook Word Excel McAfee Norton Backup use PCAnywhere MSCP or MCSE desired Blackboard Accounting and W2000 VPN a plus 9-19 hours week flexible Mon-Fri Good pay West Bloomfield location Call 248 661 2999 or fax resume 248-661 1628 attn Barb

PROGRESS PROGRAMMER Part time Progress 4XL Programmer wanted Urgent experience helpful 20.25 hrs/wk Call Bonnie at (248) 489 9700

Find it here! OBSERVER & ECCENTRIC CLASSIFIED 1-800-579-SELL observer-eccentric.com

501 Computer/Info Systems MANAGER OF INFORMATION SERVICES AND AUDITING The office of the chapter 13 Trustee Trustee in Downtown Detroit has immediate opening Responsibilities include Coordination of all computer activity and oversight of audit functions within the office Main task is to supervise an IBM RS 6000 Responsible for all peripheral computer issues Liaison to Clerk of the Court for implementation of electronic case filings Bachelors degree or 2 to 4 years related experience and/or training Salary range \$48 000-\$61 000 Salary commensurate with experience Excellent fringe benefits including 401K medical dental optical life & disability Please submit resume & salary requirements to Chapter 13 Trustee Attn Nancy Chapman 535 Griswold Suite 1230 Detroit MI 48226 Fax (313)965 1940 or Email nancyco@dct13ksc.com

502 Help Wanted-Office Clerical A BOOKKEEPER IS NEEDED! A part time position is available in our busy office in Livonia office Description computer literacy & relevant job experience is desired Thorough training will be provided Fax resume w/salary requirements to the Office Manager @ (240)471-4146

ACCOUNTANT/BOOKKEEPER For construction company Salary & full benefits Fax resume to 810 756 9040

ACCOUNTANT Westland CPA firm seeks individual with 2-3 yrs experience Computer skills a must Please send or fax resume to 6225 N Wayne Rd Westland MI 48185 Fax 734-721 2346

ACCOUNTING CLERK FAST paced corp Headquartered in Farmington Hills is seeking individual for our AP Dept Commercial experience a plus Candidates must have some accounting background attention to detail reconciliation & 10 key skills opportunity for advancement Fax or email resume to controller Jobs@Burns Wilcox.com (248) 932 9040

Accounts Receivables/Payables Person with 5-7 years experience needed for busy carpet contractor Redford Duties include AR/AP & payroll Must be computer literate and have experience with AIA documents Send resume to Controller 12870 Inkster Redford MI 48239

EMBASSY SUITES HOTEL ACCOUNTING CLERK Doubletree Southfield soon to be EMBASSY SUITES is seeking an experienced Accounting Clerk This full time position will primarily be working with all levels of employees As part of Boyk in Hospitality you would be entitled to Great Benefits Excellent Pay Advancement Opportunities and Numerous Incentives to Earn Additional Compensation For more info log on to www.boykinhotels.com Apply in person or fax resume to 28100 Franklin Rd Southfield MI 48034 Fax 248 357 2954 An Equal Opportunity Employer

Administrative Assistant Full service real estate company is seeking an administrative assistant with the knowledg of Excel and Word Excellent written and verbal communication skills Should be organized and capable of multitasking Should be comfortable with computer and organization in Michigan Send resume in strict confidence to Suburban Collection P.O. Box 8066 Nov 11 48378 9085 Attn Joan Kowalski 248 427 7972 248 427 7973 Fax

ADMINISTRATIVE For non smoking Farmington Hills office Payroll bookkeeping & general office experience preferred (248) 788 0770

ADMINISTRATIVE ASSISTANT \$37 000 to \$42 000 International suburban firm has several openings 5-7 years corp experience and Numerate Microsoft Office Benefits Call Barb 810 772 6760 Snelling Personnel Services

Administrative Assistants Magnificent Southfield Office Seeks polished individual with advanced Word & PowerPoint skills \$35 39K great benefits Many other openings! Fax resume 248 932 1214 or Call Cathy 810 772 6760 Harper Associates www.harperjobs.com

We always find the best stuff in our Classifieds! CLERICAL Full & part time positions available for Southfield office Computer skills required Send resume to Village Secretary 27350 Southfield Rd Lathrup Village MI 48076

CLERICAL Art Van Furniture is currently looking for highly motivated people who are interested in working in a fast paced office setting Full and part time positions available evenings and weekends Some typing and computer knowledge required

Full Time Positions Include: Dental Major Medical Profit Sharing Prescription Coverage 40 Hour Work Week (avg) Paid Vacation These openings are available at our beautiful Novi Store Please apply in person at ART VAN FURNITURE 2775 Novi Road Novi MI 48377 Fax 248-348-9155 Equal Opportunity Employer M/F/D/V

502 Help Wanted-Office Clerical ADMINISTRATIVE ASSISTANT Advertising Agency Financial Services Manufacturing Support Call Sharon or Email barbara@astat.com Birmingham 248 846 7663 Clinton Twp 810-226 9642 Livonia 248 473 2933

Advantage Staffing ADMINISTRATIVE SUPPORT/WORD PROCESSOR Seeking a team-oriented, full-time Word Processor for a busy office. Must possess excellent spelling, transcription, and telephone skills. Preferably legal background. Helpdesk but not necessary. Send resume with salary requirements to: DSI, Attn: Katherine, 39500 Orchard Hill Place, Suite 350, Novi, MI 48275-5272. Or fax to (248) 341-1829. Attn: Katherine

ADMINISTRATIVE SECRETARY The City of Plymouth has an opening for a full time Administrative Secretary with the Department of Municipal Services Previous computer secretarial and/or municipal or DPW experience preferred Salary range \$12 94/hr to \$16 58/hr plus benefits Complete job description and application are available at Human Resources 241 E Main St 4th fl Detroit 48170 Fax (734) 455 1892 or email resume to estone@plymouthmi.us Deadline for receipt of applications is 9 21 01 The City of Plymouth is an equal opportunity employer and does not discriminate on the basis of race color national origin religion age gender or disability

ADP TotalSource a leader in the Professional Employer Organization industry is seeking highly motivated professionals with strong client relations skills ADP TotalSource is recognized as an Employer of Choice with highly competitive compensation benefits and advancement opportunities The following positions are available in our Novi Michigan location: PAYROLL SPECIALIST Strong organizational skills attention to detail and excellent computer and customer service skills are required 2-3 yrs previous payroll experience Previous ADP experience a plus RECEPTIONIST Out going personality good communication skills and board experience to multi task some computer skills Previous experience required Interested candidates should send resume cover letter and salary requirements

ADP TotalSource A Professional Employer Organization P.O. Box 435 Novi MI 48376 or Fax to 248 374-8765 ASSISTANT NEEDED Full or part time for busy Plymouth Realtor Must have an eye for details be positive & upbeat and a self starter Computer skills are a must Real estate experience preferred Send salary requirements and available to host to: Ass. Mgr. P.O. Box 6113 Plymouth MI 48170

AUTO DEALERSHIP Suburban Collection is currently accepting applications for experienced New/Used Car Coster Compute the cost and gross profit for all new/used car deals daily Process all invoices/rebate/EP paperwork Report all vehicles sold to factory Reconcile all relevant schedules Calculate all Salesmans We offer a professional working environment competitive salary 401K paid holidays and vacations and the opportunity to advance within the largest dealer organization in Michigan Send resume in strict confidence to Suburban Collection P.O. Box 8066 Nov 11 48378 9085 Attn Joan Kowalski 248 427 7972 248 427 7973 Fax

BILLING CLERK \$26 000 3 years accounts payable/receivables some data entry Word and Excel needed Southfield firm \$5/week Great benefits Fax resume w/salary requirements to Snelling Personnel Services

BOOKKEEPER/ACCOUNTANT Must know QuickBooks Fax resume to attention Barry 248-988 5456

BOOKKEEPER Established construction company located in the Wixom area has immediate opening for a self motivated take charge individual to assist controller Knowledge of Timberline Accounting System a plus Will be responsible for A/P data entry payroll as well as various other accounting responsibilities Please fax resume w/salary requirements to Human Resources at 810-220 3666

BOOKKEEPER Half days Quickbooks experience Redford area Call (313) 387 3600

CLERICAL Full & part time positions available for Southfield office Computer skills required Send resume to Village Secretary 27350 Southfield Rd Lathrup Village MI 48076

CUSTOMER SERVICE/ DATA ENTRY Post medical payments coordinate insurance MS Word Excel Brena @ 734 459 1166

CUSTOMER SERVICE REP Computer experience Must have good communication skills Competitive salary and benefits South Lyon area Call Cynthia 248 446-4500

CUSTOMER SERVICE / DATA ENTRY CLERK For non smoking Livonia 3 branch Medical benefits Please call 734-524-7598 Or fax resume 734-524-3488

CUSTOMER SERVICE dart appraisal com in Bloomfield Hills Applicants should have experience working in a professional fast paced environment Exceptional customer service phone and computer skills are a must This opportunity is ideal for a candidate that is self motivated can perform well under pressure has solid organizational skills and the proven ability to multi task This position is full time starting at \$11 50 with full benefits Email resume to tahanna@dartappraisal.com or fax to 248 333 9445 attention Teresa

DATA ENTRY/General Office Full time person for record storage office No experience necessary but must be reliable detail oriented & able to work with the public Duties include data entry phone orders & customer service Full benefits package Fill out application between 9-4pm Corigan Record Storage 45200 Good computer skills Ford 97 Call Corigan for Barb Shipley

DISTRIBUTOR IN Wixom has immediate full time opening in food & home & chn skills Pay general office Good benefits Call Ellen (248) 960 9500

502 Help Wanted-Office Clerical BOOKKEEPER NEEDED For busy Plymouth real estate office Full or part time Computer skills are a must Experience with Peachtree is recommended Send salary requirements and available hours to Bookkeeper P.O. Box 6113 Plymouth MI 48170

BOOKKEEPER Part time 20 hrs/wk Experience in Prophet 21 System thru financial Experience & references a must Salary commensurate with experience Send resume to Attn Barbara Brown 412449 Vin cent Court Novi MI 48375

CLERICAL Full time computer knowledge helpful Send resume to MFSonia 2990 106 Mile Rd Livonia MI 48152

CLERICAL/SECRETARY Part time flexible hours Must have good WordPerfect or Word exp 734-458 1170

CLERK I/II Canton Township is accepting applications for the position of full time Clerk I/II Applicants will be considered for the equal opportunity position on a non-union basis Salary \$25 747 per yr Applications can be picked up at the Canton Township Personnel Office Building 4 Canton Town Rd Canton MI 48188 or send a self addressed stamped business size envelope to above address to request application (please specify Clerk I/II application) An application form is also available on the Canton Township website at www.cantonmi.org Job description will be posted at the Township Administration Building 4 Canton Town Rd Canton MI 48188 or send a self addressed stamped business size envelope to above address to request application (please specify Clerk I/II application) An application form is also available on the Canton Township website at www.cantonmi.org Job description will be posted at the Township Administration Building 4 Canton Town Rd Canton MI 48188 or send a self addressed stamped business size envelope to above address to request application (please specify Clerk I/II application) An application form is also available on the Canton Township website at www.cantonmi.org Job description will be posted at the Township Administration Building 4 Canton Town Rd Canton MI 48188 or send a self addressed stamped business size envelope to above address to request application (please specify Clerk I/II application) An application form is also available on the Canton Township website at www.cantonmi.org Job description will be posted at the Township Administration Building 4 Canton Town Rd Canton MI 48188 or send a self addressed stamped business size envelope to above address to request application (please specify Clerk I/II application) An application form is also available on the Canton Township website at www.cantonmi.org Job description will be posted at the Township Administration Building 4 Canton Town Rd Canton MI 48188 or send a self addressed stamped business size envelope to above address to request application (please specify Clerk I/II application) An application form is also available on the Canton Township website at www.cantonmi.org Job description will be posted at the Township Administration Building 4 Canton Town Rd Canton MI 48188 or send a self addressed stamped business size envelope to above address to request application (please specify Clerk I/II application) An application form is also available on the Canton Township website at www.cantonmi.org Job description will be posted at the Township Administration Building 4 Canton Town Rd Canton MI 48188 or send a self addressed stamped business size envelope to above address to request application (please specify Clerk I/II application) An application form is also available on the Canton Township website at www.cantonmi.org Job description will be posted at the Township Administration Building 4 Canton Town Rd Canton MI 48188 or send a self addressed stamped business size envelope to above address to request application (please specify Clerk I/II application) An application form is also available on the Canton Township website at www.cantonmi.org Job description will be posted at the Township Administration Building 4 Canton Town Rd Canton MI 48188 or send a self addressed stamped business size envelope to above address to request application (please specify Clerk I/II application) An application form is also available on the Canton Township website at www.cantonmi.org Job description will be posted at the Township Administration Building 4 Canton Town Rd Canton MI 48188 or send a self addressed stamped business size envelope to above address to request application (please specify Clerk I/II application) An application form is also available on the Canton Township website at www.cantonmi.org Job description will be posted at the Township Administration Building 4 Canton Town Rd Canton MI 48188 or send a self addressed stamped business size envelope to above address to request application (please specify Clerk I/II application) An application form is also available on the Canton Township website at www.cantonmi.org Job description will be posted at the Township Administration Building 4 Canton Town Rd Canton MI 48188 or send a self addressed stamped business size envelope to above address to request application (please specify Clerk I/II application) An application form is also available on the Canton Township website at www.cantonmi.org Job description will be posted at the Township Administration Building 4 Canton Town Rd Canton MI 48188 or send a self addressed stamped business size envelope to above address to request application (please specify Clerk I/II application) An application form is also available on the Canton Township website at www.cantonmi.org Job description will be posted at the Township Administration Building 4 Canton Town Rd Canton MI 48188 or send a self addressed stamped business size envelope to above address to request application (please specify Clerk I/II application) An application form is also available on the Canton Township website at www.cantonmi.org Job description will be posted at the Township Administration Building 4 Canton Town Rd Canton MI 48188 or send a self addressed stamped business size envelope to above address to request application (please specify Clerk I/II application) An application form is also available on the Canton Township website at www.cantonmi.org Job description will be posted at the Township Administration Building 4 Canton Town Rd Canton MI 48188 or send a self addressed stamped business size envelope to above address to request application (please specify Clerk I/II application) An application form is also available on the Canton Township website at www.cantonmi.org Job description will be posted at the Township Administration Building 4 Canton Town Rd Canton MI 48188 or send a self addressed stamped business size envelope to above address to request application (please specify Clerk I/II application) An application form is also available on the Canton Township website at www.cantonmi.org Job description will be posted at the Township Administration Building 4 Canton Town Rd Canton MI 48188 or send a self addressed stamped business size envelope to above address to request application (please specify Clerk I/II application) An application form is also available on the Canton Township website at www.cantonmi.org Job description will be posted at the Township Administration Building 4 Canton Town Rd Canton MI 48188 or send a self addressed stamped business size envelope to above address to request application (please specify Clerk I/II application) An application form is also available on the Canton Township website at www.cantonmi.org Job description will be posted at the Township Administration Building 4 Canton Town Rd Canton MI 48188 or send a self addressed stamped business size envelope to above address to request application (please specify Clerk I/II application) An application form is also available on the Canton Township website at www.cantonmi.org Job description will be posted at the Township Administration Building 4 Canton Town Rd Canton MI 48188 or send a self addressed stamped business size envelope to above address to request application (please specify Clerk I/II application) An application form is also available on the Canton Township website at www.cantonmi.org Job description will be posted at the Township Administration Building 4 Canton Town Rd Canton MI 48188 or send a self addressed stamped business size envelope to above address to request application (please specify Clerk I/II application) An application form is also available on the Canton Township website at www.cantonmi.org Job description will be posted at the Township Administration Building 4 Canton Town Rd Canton MI 48188 or send a self addressed stamped business size envelope to above address to request application (please specify Clerk I/II application) An application form is also available on the Canton Township website at www.cantonmi.org Job description will be posted at the Township Administration Building 4 Canton Town Rd Canton MI 48188 or send a self addressed stamped business size envelope to above address to request application (please specify Clerk I/II application) An application form is also available on the Canton Township website at www.cantonmi.org Job description will be posted at the Township Administration Building 4 Canton Town Rd Canton MI 48188 or send a self addressed stamped business size envelope to above address to request application (please specify Clerk I/II application) An application form is also available on the Canton Township website at www.cantonmi.org Job description will be posted at the Township Administration Building 4 Canton Town Rd Canton MI 48188 or send a self addressed stamped business size envelope to above address to request application (please specify Clerk I/II application) An application form is also available on the Canton Township website at www.cantonmi.org Job description will be posted at the Township Administration Building 4 Canton Town Rd Canton MI 48188 or send a self addressed stamped business size envelope to above address to request application (please specify Clerk I/II application) An application form is also available on the Canton Township website at www.cantonmi.org Job description will be posted at the Township Administration Building 4 Canton Town Rd Canton MI 48188 or send a self addressed stamped business size envelope to above address to request application (please specify Clerk I/II application) An application form is also available on the Canton Township website at www.cantonmi.org Job description will be posted at the Township Administration Building 4 Canton Town Rd Canton MI 48188 or send a self addressed stamped business size envelope to above address to request application (please specify Clerk I/II application) An application form is also available on the Canton Township website at www.cantonmi.org Job description will be posted at the Township Administration Building 4 Canton Town Rd Canton MI 48188 or send a self addressed stamped business size envelope to above address to request application (please specify Clerk I/II application) An application form is also available on the Canton Township website at www.cantonmi.org Job description will be posted at the Township Administration Building 4 Canton Town Rd Canton MI 48188 or send a self addressed stamped business size envelope to above address to request application (please specify Clerk I/II application) An application form is also available on the Canton Township website at www.cantonmi.org Job description will be posted at the Township Administration Building 4 Canton Town Rd Canton MI 48188 or send a self addressed stamped business size envelope to above address to request application (please specify Clerk I/II application) An application form is also available on the Canton Township website at www.cantonmi.org Job description will be posted at the Township Administration Building 4 Canton Town Rd Canton MI 48188 or send a self addressed stamped business size envelope to above address to request application (please specify Clerk I/II application) An application form is also available on the Canton Township website at www.cantonmi.org Job description will be posted at the Township Administration Building 4 Canton Town Rd Canton MI 48188 or send a self addressed stamped business size envelope to above address to request application (please specify Clerk I/II application) An application form is also available on the Canton Township website at www.cantonmi.org Job description will be posted at the Township Administration Building 4 Canton Town Rd Canton MI 48188 or send a self addressed stamped business size envelope to above address to request application (please specify Clerk I/II application) An application form is also available on the Canton Township website at www.cantonmi.org Job description will be posted at the Township Administration Building 4 Canton Town Rd Canton MI 48188 or send a self addressed stamped business size envelope to above address to request application (please specify Clerk I/II application) An application form is also available on the Canton Township website at www.cantonmi.org Job description will be posted at the Township Administration Building 4 Canton Town Rd Canton MI 48188 or send a self addressed stamped business size envelope to above address to request application (please specify Clerk I/II application) An application form is also available on the Canton Township website at www.cantonmi.org Job description will be posted at the Township Administration Building 4 Canton Town Rd Canton MI 48188 or send a self addressed stamped business size envelope to above address to request application (please specify Clerk I/II application) An application form is also available on the Canton Township website at www.cantonmi.org Job description will be posted at the Township Administration Building 4 Canton Town Rd Canton MI 48188 or send a self addressed stamped business size envelope to above address to request application (please specify Clerk I/II application) An application form is also available on the Canton Township website at www.cantonmi.org Job description will be posted at the Township Administration Building 4 Canton Town Rd Canton MI 48188 or send a self addressed stamped business size envelope to above address to request application (please specify Clerk I/II application) An application form is also available on the Canton Township website at www.cantonmi.org Job description will be posted at the Township Administration Building 4 Canton Town Rd Canton MI 48188 or send a self addressed stamped business size envelope to above address to request application (please specify Clerk I/II application) An application form is also available on the Canton Township website at www.cantonmi.org Job description will be posted at the Township Administration Building 4 Canton Town Rd Canton MI 48188 or send a self addressed stamped business size envelope to above address to request application (please specify Clerk I/II application) An application form is also available on the Canton Township website at www.cantonmi.org Job description will be posted at the Township Administration Building 4 Canton Town Rd Canton MI 48188 or send a self addressed stamped business size envelope to above address to request application (please specify Clerk I/II application) An application form is also available on the Canton Township website at www.cantonmi.org Job description will be posted at the Township Administration Building 4 Canton Town Rd Canton MI 48188 or send a self addressed stamped business size envelope to above address to request application (please specify Clerk I/II application) An application form is also available on the Canton Township website at www.cantonmi.org Job description will be posted at the Township Administration Building 4 Canton Town Rd Canton MI 48188 or send a self addressed stamped business size envelope to above address to request application (please specify Clerk I/II application) An application form is also available on the Canton Township website at www.cantonmi.org Job description will be posted at the Township Administration Building 4 Canton Town Rd Canton MI 48188 or send a self addressed stamped business size envelope to above address to request application (please specify Clerk I/II application) An application form is also available on the Canton Township website at www.cantonmi.org Job description will be posted at the Township Administration Building 4 Canton Town Rd Canton MI 48188 or send a self addressed stamped business size envelope to above address to request application (please specify Clerk I/II application) An application form is also available on the Canton Township website at www.cantonmi.org Job description will be posted at the Township Administration Building 4 Canton Town Rd Canton MI 48188 or send a self addressed stamped business size envelope to above address to request application (please specify Clerk I/II application) An application form is also available on the Canton Township website at www.cantonmi.org Job description will be posted at the Township Administration Building 4 Canton Town Rd Canton MI 48188 or send a self addressed stamped business size envelope to above address to request application (please specify Clerk I/II application) An application form is also available on the Canton Township website at www.cantonmi.org Job description will be posted at the Township Administration Building 4 Canton Town Rd Canton MI 48188 or send a self addressed stamped business size envelope to above address to request application (please specify Clerk I/II application) An application form is also available on the Canton Township website at www.cantonmi.org Job description will be posted at the Township Administration Building 4 Canton Town Rd Canton MI 48188 or send a self addressed stamped business size envelope to above address to request application (please specify Clerk I/II application) An application form is also available on the Canton Township website at www.cantonmi.org Job description will be posted at the Township Administration Building 4 Canton Town Rd Canton MI 48188 or send a self addressed stamped business size envelope to above address to request application (please specify Clerk I/II application) An application form is also available on the Canton Township website at www.cantonmi.org Job description will be posted at the Township Administration Building 4 Canton Town Rd Canton MI 48188 or send a self addressed stamped business size envelope to above address to request application (please specify Clerk I/II application) An application form is also available on the Canton Township website at www.cantonmi.org Job description will be posted at the Township Administration Building 4 Canton Town Rd Canton MI 48188 or send a self addressed stamped business size envelope to above address to request application (please specify Clerk I/II application) An application form is also available on the Canton Township website at www.cantonmi.org Job description will be posted at the Township Administration Building 4 Canton Town Rd Canton MI 48188 or send a self addressed stamped business size envelope to above address to request application (please specify Clerk I/II application) An application form is also available on the Canton Township website at www.cantonmi.org Job description will be posted at the Township Administration Building 4 Canton Town Rd Canton MI 48188 or send a self addressed stamped business size envelope to above address to request application (please specify Clerk I/II application) An application form is also available on the Canton Township website at www.cantonmi.org Job description will be posted at the Township Administration Building 4 Canton Town Rd Canton MI 48188 or send a self addressed stamped business size envelope to above address to request application (please specify Clerk I/II application) An application form is also available on the Canton Township website at www.cantonmi.org Job description will be posted at the Township Administration Building 4 Canton Town Rd Canton MI 48188 or send a self addressed stamped business size envelope to above address to request application (please specify Clerk I/II application) An application form is also available on the Canton Township website at www.cantonmi.org Job description will be posted at the Township Administration Building 4 Canton Town Rd Canton MI 48188 or send a self addressed stamped business size envelope to above address to request application (please specify Clerk I/II application) An application form is also available on the Canton Township website at www.cantonmi.org Job description will be posted at the Township Administration Building 4 Canton Town Rd Canton MI 48188 or send a self addressed stamped business size envelope to above address to request application (please specify Clerk I/II application) An application form is also available on the Canton Township website at www.cantonmi.org Job description will be posted at the Township Administration Building 4 Canton Town Rd Canton MI 48188 or send a self addressed stamped business size envelope to above address to request application (please specify Clerk I/II application) An application form is also available on the Canton Township website at www.cantonmi.org Job description will be posted at the Township Administration Building 4 Canton Town Rd Canton MI 48188 or send a self addressed stamped business size envelope to above address to request application (please specify Clerk I/II application) An application form is also available on the Canton Township website at www.cantonmi.org Job description will be posted at the Township Administration Building 4 Canton Town Rd Canton MI 48188 or send a self addressed stamped business size envelope to above address to request application (please specify Clerk I/II application) An application form is also available on the Canton Township website at www.cantonmi.org Job description will be posted at the Township Administration Building 4 Canton Town Rd Canton MI 48188 or send a self addressed stamped business size envelope to above address to request application (please specify Clerk I/II application) An application form is also available on the Canton Township website at www.cantonmi.org Job description will be posted at the Township Administration Building 4 Canton Town Rd Canton MI 48188 or send a self addressed stamped business size envelope to above address to request application (please specify Clerk I/II application) An application form is also available on the Canton Township website at www.cantonmi.org Job description will be posted at the Township Administration Building 4 Canton Town Rd Canton MI 48188 or send a self addressed stamped business size envelope to above address to request application (please specify Clerk I/II application) An application form is also available on the Canton Township website at www.cantonmi.org Job description will be posted at the Township Administration Building 4 Canton Town Rd Canton MI 48188 or send a self addressed stamped business size envelope to above address to request application (please specify Clerk I/II application) An application form is also available on the Canton Township website at www.cantonmi.org Job description will be posted at the Township Administration Building 4 Canton Town Rd Canton MI 48188 or send a self addressed stamped business size envelope to above address to request application (please specify Clerk I/II application) An application form is also available on the Canton Township website at www.cantonmi.org Job description will be posted at the Township Administration Building 4 Canton Town Rd Canton MI 48188 or send a self addressed stamped business size envelope to above address to request application (please specify Clerk I/II application) An application form is also available on the Canton Township website at www.cantonmi.org Job description will be posted at the Township Administration Building 4 Canton Town Rd Canton MI 48188 or send a self addressed stamped business size envelope to above address to request application (please specify Clerk I/II application) An application form is also available on the Canton Township website at www.cantonmi.org Job description will be posted at the Township Administration Building 4 Canton Town Rd Canton MI 48188 or send a self addressed stamped business size envelope to above address to request application (please specify Clerk I/II application) An application form is also available on the Canton Township website at www.cantonmi.org Job description will be posted at the Township Administration Building 4 Canton Town Rd Canton MI 48188 or send a self addressed stamped business size envelope to above address to request application (please specify Clerk I/II application) An application form is also available on the Canton Township website at www.cantonmi.org Job description will be posted at the Township Administration Building 4 Canton Town Rd Canton MI 48188 or send a self addressed stamped business size envelope to above address to request application (please specify Clerk I/II application) An application form is also available on the Canton Township website at www.cantonmi.org Job description will be posted at the Township Administration Building 4 Canton Town Rd Canton MI 48188 or send a self addressed stamped business size envelope to above address to request application (please specify Clerk I/II application) An application form is also available on the Canton Township website at www.cantonmi.org Job description will be posted at the Township Administration Building 4 Canton Town Rd Canton MI 48188 or send a self addressed stamped business size envelope to above address to request application (please specify Clerk I/II application) An application form is also available on the Canton Township website at www.cantonmi.org Job description will be posted at the Township Administration Building 4 Canton Town Rd Canton MI 48188 or send a self addressed stamped business size envelope to above address to request application (please specify Clerk I/II application) An application form is also available on the Canton Township website at www.cantonmi.org Job description will be posted at the Township Administration Building 4 Canton Town Rd Canton MI 48188 or send a self addressed stamped business size envelope to above address to request application (please specify Clerk I/II application) An application form is also available on the Canton Township website at www.cantonmi.org Job description will be posted at the Township Administration Building 4 Canton Town Rd Canton MI 48188 or send a self addressed stamped business size envelope to above address to request application (please specify Clerk I/II application) An application form is also available on the Canton Township website at www.cantonmi.org Job description will be posted at the Township Administration Building 4 Canton Town Rd Canton MI 48188 or send a self addressed stamped business size envelope to above address to request application (please specify Clerk I/II application) An application form is also available on the Canton Township website at www.cantonmi.org Job description will be posted at the Township Administration Building 4 Canton Town Rd Canton MI 48188 or send a self addressed stamped business size envelope to above address to request application (please specify Clerk I/II application) An application form is also available on the Canton Township website at www.cantonmi.org Job description will be posted at the Township Administration Building 4 Canton Town Rd Canton MI 48188 or send a self addressed stamped business size envelope to above address to request application (please specify Clerk I/II application) An application form is also available on the Canton Township website at www.cantonmi.org Job description will be posted at the Township Administration Building 4 Canton Town Rd Canton MI 48188 or send a self addressed stamped business size envelope to above address to request application (please specify Clerk I/II application) An application form is also available on the Canton Township website at www.cantonmi.org Job description will be posted at the Township Administration Building 4 Canton Town Rd Canton MI 48188 or send a self addressed stamped business size envelope to above address to request application (please specify Clerk I/II application) An application form is also available on the Canton Township website at www.cantonmi.org Job description will be posted at the Township Administration Building 4 Canton Town Rd Canton MI 48188 or send a self addressed stamped business size envelope to above address to request application (please specify Clerk I/II application) An application form is also available on the Canton Township website at www.cantonmi.org Job description will be posted at the Township Administration Building 4 Canton Town Rd Canton MI 48188 or send a self addressed stamped business size envelope to above address to request application (please specify Clerk I/II application) An application form is also available on the Canton Township website at www.cantonmi.org Job description will be posted at the Township Administration Building 4 Canton Town Rd Canton MI 48188 or send a self addressed stamped business size envelope to above address to request application (please specify Clerk I/II application) An application form is also available on the Canton Township website at www.cantonmi.org Job description will be posted at the Township Administration Building 4 Canton Town Rd Canton MI 48188 or send a self addressed stamped business size envelope to above address to request application (please specify Clerk I/II application) An application form is also available on the Canton Township website at www.cantonmi.org Job description will be posted at the Township Administration Building 4 Canton Town Rd Canton MI 48188 or send a self addressed stamped business size envelope to above address to request application (please specify Clerk I/II application) An application form is also available on the Canton Township website at www.cantonmi.org Job description will be posted at the Township Administration Building 4 Canton Town Rd Canton MI 48188 or send a self addressed stamped business size envelope to above address to request application (please specify Clerk I/II application) An application form is also available on the Canton Township website at www.cantonmi.org Job description will be posted at the Township Administration Building 4 Canton Town Rd Canton MI 48188 or send a self addressed stamped business size envelope to above address to request application (please specify Clerk I/II application) An application form is also available on the Canton Township website at www.cantonmi.org Job description will be posted at the Township Administration Building 4 Canton Town Rd Canton MI 48188 or send a self addressed stamped business size envelope to above address to request application (please specify Clerk I/II application) An application form is also available on the Canton Township website at www.cantonmi.org Job description will be posted at the Township Administration Building 4 Canton Town Rd Canton MI 48188 or send a self addressed stamped business size envelope to above address to request application (please specify Clerk I/II application) An application form is also available on the Canton Township website at www.cantonmi.org Job description will be posted at the Township Administration Building 4 Canton Town Rd Canton MI 48188 or send a self addressed stamped business size envelope to above address to request application (please specify Clerk I/II application) An application form is also available on the Canton Township website at www.cantonmi.org Job description will be posted at the Township Administration Building 4 Canton Town Rd Canton MI 48188 or send a self addressed stamped business size envelope to above address to request application (please specify Clerk I/II application) An application form is also available on the Canton Township website at www.cantonmi.org Job description will be posted at the Township Administration Building 4 Canton Town Rd Canton MI 48188 or send a self addressed stamped business size envelope to above address to request application (please specify Clerk I/II application) An application form is also available on the Canton Township website at www.cantonmi.org Job description will be posted at the Township Administration Building 4 Canton Town Rd Canton MI 48188 or send a self addressed stamped business size envelope to above address to request application (please specify Clerk I/II application) An application form is also available on the Canton Township website at www.cantonmi.org Job description will be posted at the Township Administration Building 4 Canton Town Rd Canton MI 48188 or send a self addressed stamped business size envelope to above address to request application (please specify Clerk I/II application) An application form is also available on the Canton Township website at www.cantonmi.org Job description will be posted at the Township Administration Building 4 Canton Town Rd Canton MI 48188 or send a self addressed stamped business size envelope to above address to request application (please specify Clerk I/II application) An application form is also available on the Canton Township website at www.cantonmi.org Job description will be posted at the Township Administration Building 4 Canton Town Rd Canton MI 48188 or send a self addressed stamped business size envelope to above address to request application (please specify Clerk I/II application) An application form is also available on the Canton Township website at www.cantonmi.org Job description will be posted at the Township Administration Building 4 Canton Town Rd Canton MI 48188 or send a self addressed stamped business size envelope to above address to request application (please specify Clerk I/II application) An application form is also available on the Canton Township website at www.cantonmi.org Job description will be posted at the Township Administration Building 4 Canton Town Rd Canton MI 48188 or send a self addressed stamped business size envelope to above address to request application (please specify Clerk I/II application) An application form is also available on the Canton Township website at www.cantonmi.org Job description will be posted at the Township Administration Building 4 Canton Town Rd Canton MI 48188 or send a self addressed stamped business size envelope to above address to request application (please specify Clerk I/II application) An application form is also available on the Canton Township website at www.cantonmi.org Job description will be posted at the Township Administration Building 4 Canton Town Rd Canton MI 48188 or send a self addressed stamped business size envelope to above address to request application (please specify Clerk I/II application) An application form is also available on the Canton Township website at www.cantonmi.org Job description will be posted at the Township Administration Building 4 Canton Town Rd Canton MI 48188 or send a self addressed stamped business size envelope to above address to request application (please specify Clerk I/II application) An application form is also available on the Canton Township website at www.cantonmi.org Job description will be posted at the Township Administration Building 4 Canton Town Rd Canton MI 48188 or send a self addressed stamped business size envelope to above address to request application (please specify Clerk I/II application) An application form is also available on the Canton Township website at www.cantonmi.org Job description will be posted at the Township Administration Building 4 Canton Town Rd Canton MI 48188 or send a self addressed stamped business size envelope to above address to request application (please specify Clerk I/II application) An application form is also available on the Canton Township website at www.cantonmi.org Job description will be posted at the Township Administration Building 4 Canton Town Rd Canton MI 48188 or send a self addressed stamped business size envelope to above address to request application (please specify Clerk I/II application) An application form is also available on the Canton Township website at www.cantonmi.org Job description will be posted at the Township Administration Building 4 Canton Town Rd Canton MI 48188 or send a self addressed stamped business size envelope to above address to request application (please specify Clerk I/II application) An application form is also available on the Canton Township website at www.cantonmi.org Job

Your classified ad is automatically posted on the internet! Visit us today

504 Help Wanted-Dental

DENTAL ASSISTANT Experienced only Full time friendly Farmington office Ben...

DENTAL ASSISTANT Exp Full time Troy Office • Competitive Salary • Medical & Dental • Paid Vacation • Retirement Plan

DENTAL HYGIENIST PART TIME for W Dearborn dental office Call 313 274-5080

Dental Hygienist Full time position for friendly Farmington office Benefits (248)478-3285

DENTAL HYGIENIST Full-time & part time Group practice in Westland Enthusiastic person who enjoys people Pay commensurate with exp Excellent benefits 401K (734) 722 7773

DENTAL HYGIENIST for solo family practice in Redford/Dearborn Heights area Call 313 531 7800 fax 313-531 7801

DENTAL HYGIENIST 25+ hours Benefits Profit sharing Dearborn Heights area (313) 565 0373

DENTAL HYGIENIST Experienced A Novi office where individualized customized quality patient care is practiced Focused on soft tissue management Mon thru Thurs Flexible hrs 248-477 7230

DENTAL HYGIENIST Great opportunity & compensation in friendly Livonia office 2 3 days 248 788 4041

DENTAL HYGIENIST Full time Approx 31 hours per week Some evenings Health insurance pension southfield Call Marie (248) 352 7722

DENTAL HYGIENIST needed Benefits 13 Mile & Telegraph 248 645-6363

DENTAL HYGIENIST For Farmington Office all day Thurs w/ additional days to become available in the future 248 474-4600

DENTAL HYGIENIST needed for 12 Oaks Mall area please call 248-374-0128 for confidential interview or Fax resume to 248 374-0128

DENTAL HYGIENIST For progressive Plymouth Practice Mon & Thurs 8 5 Fri needed in future contact Carol (734)454-5656

DENTAL HYGIENIST Canton office looking for team oriented person with focus on warmth caring and excellent communication with our patients Great support team for anyone looking to enhance their skills in a flexible environment Call 734-981 5455

DENTAL HYGIENIST Dependable team players wanted for full time at our Woodhaven office Excellent benefits vacation and personal time with guaranteed salary plus commission \$500.00 hiring bonus Call Barbara or Dr Putz at (734) 676-7878 for more information or fax resume to (734)676 6347 EOE

DENTAL / ORTHODONTIC ASSISTANT For Orthodontic office in Farmington Hills Full time Expensive in caring and excellent communication with our patients Good with people especially children Excellent salary medical and dental benefits Mature person desiring long term commitment a caring pleasant office apply by calling 1 248 855 4142 Mon Tues Thurs- Fri 9 to 4pm

DENTAL & ORTHO STAFF Expanding dental offices located in Livonia Southfield and Waterford are in need of the following EXPERIENCED staff ortho tech patient coordinator and dental assistant Positions are full time Competitive compensation plus benefits including Blue Cross medical Contact Linda Weber at (248) 203 1120 or fax resume (preferred) to (248) 203 1112

DENTAL RECEPTIONIST Full time position Experience preferred Receptionist office staff Livonia area (734) 525 3150

DENTAL STAFF Assistant & Receptionist needed for growing practice 12 Mile & Northwestern 3 days female doctor Fax resume to 248 354 8893 or leave message 734-788 2409

DENTAL TECHNICIAN Livonia denture lab has opening for finisher 40 hrs/weekends Benefits Will pay for experience call Dave 734-427-8300

FRONT DESK Full time Warm family dental office in Southfield Experience preferred No Saturdays Ask for Jackie (248) 352 1110

FRONT DESK Part time hrs needed for Livonia dental practice (734) 464-7770

HYGIENIST MANAGER/HYGIENIST Looking for a Hygienist with managerial skills for group practice in Westland Pay commensurate with experience Excellent benefits 401K (734) 722 7773

HYGIENIST Full or part time friendly progressive Northville office once soft tissue management skills a must Please call 248-347-0707

HYGIENIST Southfield dental office Perio oriented/general office Flexible hours Some Saturdays Fax resume 248 646-2434

RECEPTIONIST/CLERICAL ASSISTANT For Farmington Hills Law office or part time Skills required full or part time Ask for Barbara 248-538 1800

504 Help Wanted-Dental

ORTHODONTIC DEGREE in orthodontics Our progressive newly expanded office in Novi is hiring full/part time position No Saturdays Exp preferred but not necessary we offer in office training & benefit package you enjoy working with children in an upbeat friendly atmosphere call (248) 344 8400

RECEPTIONIST Southfield dental office Flexible Afternoon hours Some Saturdays Will train Fax resume 248-646 2434

ADMINISTRATIVE ASSISTANT Medical office seeks experienced receptionist Full time with excellent pay and benefits Ann Arbor/Plymouth area Fax resume to (734) 998-8767

AIDES part time evenings for Wayne County Please call between 9am 5pm 734 525 6825

ASSISTANT Experienced full time or part time medical assistant wanted for a busy Livonia family practice office Please contact Lori Mon-Fri 8-4pm (734) 462-0090

Billers & Receptionists Southfield practice seeks polished Front Desk Coordinator College Education preferred Part time Biller Medical Rochester Hills Many locations! Fax resume 248 932 1214 or call Angie 248 932 1202

Southfield practice seeks polished Front Desk Coordinator College Education preferred Part time Biller Medical Rochester Hills Many locations! Fax resume 248 932 1214 or call Angie 248 932 1202

Southfield practice seeks polished Front Desk Coordinator College Education preferred Part time Biller Medical Rochester Hills Many locations! Fax resume 248 932 1214 or call Angie 248 932 1202

Southfield practice seeks polished Front Desk Coordinator College Education preferred Part time Biller Medical Rochester Hills Many locations! Fax resume 248 932 1214 or call Angie 248 932 1202

Southfield practice seeks polished Front Desk Coordinator College Education preferred Part time Biller Medical Rochester Hills Many locations! Fax resume 248 932 1214 or call Angie 248 932 1202

Southfield practice seeks polished Front Desk Coordinator College Education preferred Part time Biller Medical Rochester Hills Many locations! Fax resume 248 932 1214 or call Angie 248 932 1202

Southfield practice seeks polished Front Desk Coordinator College Education preferred Part time Biller Medical Rochester Hills Many locations! Fax resume 248 932 1214 or call Angie 248 932 1202

Southfield practice seeks polished Front Desk Coordinator College Education preferred Part time Biller Medical Rochester Hills Many locations! Fax resume 248 932 1214 or call Angie 248 932 1202

Southfield practice seeks polished Front Desk Coordinator College Education preferred Part time Biller Medical Rochester Hills Many locations! Fax resume 248 932 1214 or call Angie 248 932 1202

Southfield practice seeks polished Front Desk Coordinator College Education preferred Part time Biller Medical Rochester Hills Many locations! Fax resume 248 932 1214 or call Angie 248 932 1202

Southfield practice seeks polished Front Desk Coordinator College Education preferred Part time Biller Medical Rochester Hills Many locations! Fax resume 248 932 1214 or call Angie 248 932 1202

Southfield practice seeks polished Front Desk Coordinator College Education preferred Part time Biller Medical Rochester Hills Many locations! Fax resume 248 932 1214 or call Angie 248 932 1202

Southfield practice seeks polished Front Desk Coordinator College Education preferred Part time Biller Medical Rochester Hills Many locations! Fax resume 248 932 1214 or call Angie 248 932 1202

Southfield practice seeks polished Front Desk Coordinator College Education preferred Part time Biller Medical Rochester Hills Many locations! Fax resume 248 932 1214 or call Angie 248 932 1202

Southfield practice seeks polished Front Desk Coordinator College Education preferred Part time Biller Medical Rochester Hills Many locations! Fax resume 248 932 1214 or call Angie 248 932 1202

Southfield practice seeks polished Front Desk Coordinator College Education preferred Part time Biller Medical Rochester Hills Many locations! Fax resume 248 932 1214 or call Angie 248 932 1202

Southfield practice seeks polished Front Desk Coordinator College Education preferred Part time Biller Medical Rochester Hills Many locations! Fax resume 248 932 1214 or call Angie 248 932 1202

Southfield practice seeks polished Front Desk Coordinator College Education preferred Part time Biller Medical Rochester Hills Many locations! Fax resume 248 932 1214 or call Angie 248 932 1202

Southfield practice seeks polished Front Desk Coordinator College Education preferred Part time Biller Medical Rochester Hills Many locations! Fax resume 248 932 1214 or call Angie 248 932 1202

Southfield practice seeks polished Front Desk Coordinator College Education preferred Part time Biller Medical Rochester Hills Many locations! Fax resume 248 932 1214 or call Angie 248 932 1202

Southfield practice seeks polished Front Desk Coordinator College Education preferred Part time Biller Medical Rochester Hills Many locations! Fax resume 248 932 1214 or call Angie 248 932 1202

Southfield practice seeks polished Front Desk Coordinator College Education preferred Part time Biller Medical Rochester Hills Many locations! Fax resume 248 932 1214 or call Angie 248 932 1202

Southfield practice seeks polished Front Desk Coordinator College Education preferred Part time Biller Medical Rochester Hills Many locations! Fax resume 248 932 1214 or call Angie 248 932 1202

Southfield practice seeks polished Front Desk Coordinator College Education preferred Part time Biller Medical Rochester Hills Many locations! Fax resume 248 932 1214 or call Angie 248 932 1202

Southfield practice seeks polished Front Desk Coordinator College Education preferred Part time Biller Medical Rochester Hills Many locations! Fax resume 248 932 1214 or call Angie 248 932 1202

Southfield practice seeks polished Front Desk Coordinator College Education preferred Part time Biller Medical Rochester Hills Many locations! Fax resume 248 932 1214 or call Angie 248 932 1202

Southfield practice seeks polished Front Desk Coordinator College Education preferred Part time Biller Medical Rochester Hills Many locations! Fax resume 248 932 1214 or call Angie 248 932 1202

Southfield practice seeks polished Front Desk Coordinator College Education preferred Part time Biller Medical Rochester Hills Many locations! Fax resume 248 932 1214 or call Angie 248 932 1202

Southfield practice seeks polished Front Desk Coordinator College Education preferred Part time Biller Medical Rochester Hills Many locations! Fax resume 248 932 1214 or call Angie 248 932 1202

Southfield practice seeks polished Front Desk Coordinator College Education preferred Part time Biller Medical Rochester Hills Many locations! Fax resume 248 932 1214 or call Angie 248 932 1202

Southfield practice seeks polished Front Desk Coordinator College Education preferred Part time Biller Medical Rochester Hills Many locations! Fax resume 248 932 1214 or call Angie 248 932 1202

Southfield practice seeks polished Front Desk Coordinator College Education preferred Part time Biller Medical Rochester Hills Many locations! Fax resume 248 932 1214 or call Angie 248 932 1202

Southfield practice seeks polished Front Desk Coordinator College Education preferred Part time Biller Medical Rochester Hills Many locations! Fax resume 248 932 1214 or call Angie 248 932 1202

Southfield practice seeks polished Front Desk Coordinator College Education preferred Part time Biller Medical Rochester Hills Many locations! Fax resume 248 932 1214 or call Angie 248 932 1202

Southfield practice seeks polished Front Desk Coordinator College Education preferred Part time Biller Medical Rochester Hills Many locations! Fax resume 248 932 1214 or call Angie 248 932 1202

Southfield practice seeks polished Front Desk Coordinator College Education preferred Part time Biller Medical Rochester Hills Many locations! Fax resume 248 932 1214 or call Angie 248 932 1202

Southfield practice seeks polished Front Desk Coordinator College Education preferred Part time Biller Medical Rochester Hills Many locations! Fax resume 248 932 1214 or call Angie 248 932 1202

Southfield practice seeks polished Front Desk Coordinator College Education preferred Part time Biller Medical Rochester Hills Many locations! Fax resume 248 932 1214 or call Angie 248 932 1202

506 Help Wanted-Medical

ECHO & ULTRA SOUND TECH Experienced tech needed for part time position Northville office Fax resume to (248) 380 1344

EMTS - PARAMEDICS Concord EMS is a growing company needing qualified people to provide quality patient care We are developing new areas of business and need licensed EMTs and Paramedics who want good equipment good pay and flexible hours with accumulative benefit results

* \$1000.00 sign on Bonus * Health and Dental * Short term disability * Tuition reimbursement * Accumulate PTO * 401K * Competitive wage * Night shift premium * 313-368-9400 or 734-947 9400 248 967 9400

Exciting New Career in Emergency Medical Services Job Placement & Tuition Reimbursement Classes starting in September Emergency Medical Technician and Paramedic Life Support Training Institute (affiliated w/ Community EMS and Boisford Hospital) Call (248) 356 3900 ext 5265 or register online at www.communityems.org

EMT/Paramedic Bloomfield 3175 N Adams Road Bloomfield Hills MI 48304 Fax 248-433 1415

LPN Full time for afternoons RN Part time for mornings Bloomfield Hills MI 48304 Fax 248-433 1415

LPN Part time for busy allergy practice 15 20 hrs/week Farmington Hills & Livonia locations (248) 851 6657

Contingent Positions Now Available Fax resume to 248-477 2888 Farmington Health Care Center 34225 Grand River Farmington Hills

MAMMOGRAPHER PART TIME Responsible dependable cert in mammography tech needed for busy radiology office located in Wayne Fax resume to (734) 326 3999 or mail to 4491 Venoxy Rd Wayne

MEDICAL ASSISTANT For busy internal medicine office Experienced only Full time Please contact office manager (248)927 4322

MEDICAL ASSISTANT/PRN/RN Medical examiners needed to perform mbol medical evaluation Must have good phlebotomy and related radiology skills plus mileage pay Day and afternoon shifts available Fax resume to (248)544-1971

FRONT DESK FULL TIME Chiropactic or retail experience Will train Farmington Hills Call 248 213 5182

FRONT DESK/RECEPTIONIST BUSY INTERNAL Medicine office accepting applications for full time front desk position Experience preferred Fax resume to Clinical Manager (734) 981 0653

FRONT OFFICE HELP Full time needed for Westland office Fax resume to 734-728 1400

FRONT OFFICE Looking for career minded individual to work at alternative health care practice Competitive experience preferred 401K & benefits Send resume to 39955 W 10 Mile #112 Novi MI 48375 Attn Pam

HOME HEALTH AIDE Sat 8 4pm shift Private residence Commerce Twp Leave message (248) 407 7523

INEXPERIENCED? AGGRESSIVE? OVERPAID? We will train you to earn 70K+ your first year One of the largest companies in its field is looking for reps that are career oriented Confirmed appointments best product line available Call Mr Wright (734)762 9090

Infant Support Specialist Home Visiting Nurse Corner Health Center will hire an RN to provide home based assessment & parenting education Full time with benefits RN plus 2 yrs experience infant mental health background a must apply to Beverly Johnson Corner Health Center 47 N Huron St Ypsilanti MI 48197 Fax 734-484-3100 EOE

INSTRUMENT TECHNICIAN/STERILE PROCESSING Leading medical processor in the Westland area has an opening for person with laparoscopic instrument processing skills Instrument technician certification and/or 2 plus years experience necessary Keep accurate records follow SOP's Opportunities available for lead positions FDA regulated environment Pay commensurate with experience good benefits Fax resume including salary history to 734-595 7644 or mail to SRI/SURGICAL EXPRESS 38120 Webb Drive Westland MI 48185 EOE

INSURANCE CLERK Part time Experience helpful in claim follow up Benefits available Call Sherry 248-477 8939

Large and busy Royal Oak Oncology practice has openings for the following positions:

* MEDICAL ASSISTANT Full time experience required

* REGISTERED NURSE Full time outpatient oncology experience required

* MEDICAL LAB TECHNICIAN Full time

* INSURANCE SPECIALIST Full time experience verifying insurance benefits Some data entry and phone calls

We offer a competitive salary and generous benefit package that includes profit sharing If you are looking for a challenging and rewarding position send your resume to Human Resources at (248) 551 6909

Medical Biller / Data Entry Needed for orthopedic surgeons office in Novi Fax resume to Janet (248) 969 1788

Medical Assistant/ LPN An established Family Practice office in Plymouth is seeking a full time Medical Assistant/LPN Duties include providing professional clinical care to patients following established standards and practices Certified M of LPN required We offer a competitive salary with an excellent benefit package Interested applicants may send their resume to Nancy Kelley 390 W Ann Arbor Trail Suite 207 Plymouth MI 48170 or fax to (734) 453 8721 www.ihcare.com

Medical Biller Experience required Excellent benefits Competitive salary Friendly atmosphere Plymouth area Call Maria S 734-453 6970

Medical Receptionist / Data Entry Needed for orthopedic surgeons office in Novi Fax resume to Janet (248) 969 1788

Medical Receptionist Full time position for busy physical therapy office in Farmington Hills Exp 401K & benefits Fax resume to (734) 927 4322

Medical Receptionist Full time position for busy physical therapy office in Farmington Hills Exp 401K & benefits Fax resume to (734) 927 4322

Medical Receptionist Full time position for busy physical therapy office in Farmington Hills Exp 401K & benefits Fax resume to (734) 927 4322

Medical Receptionist Full time position for busy physical therapy office in Farmington Hills Exp 401K & benefits Fax resume to (734) 927 4322

Medical Receptionist Full time position for busy physical therapy office in Farmington Hills Exp 401K & benefits Fax resume to (734) 927 4322

Medical Receptionist Full time position for busy physical therapy office in Farmington Hills Exp 401K & benefits Fax resume to (734) 927 4322

Medical Receptionist Full time position for busy physical therapy office in Farmington Hills Exp 401K & benefits Fax resume to (734) 927 4322

Medical Receptionist Full time position for busy physical therapy office in Farmington Hills Exp 401K & benefits Fax resume to (734) 927 4322

Medical Receptionist Full time position for busy physical therapy office in Farmington Hills Exp 401K & benefits Fax resume to (734) 927 4322

Medical Receptionist Full time position for busy physical therapy office in Farmington Hills Exp 401K & benefits Fax resume to (734) 927 4322

Medical Receptionist Full time position for busy physical therapy office in Farmington Hills Exp 401K & benefits Fax resume to (734) 927 4322

Medical Receptionist Full time position for busy physical therapy office in Farmington Hills Exp 401K & benefits Fax resume to (734) 927 4322

Medical Receptionist Full time position for busy physical therapy office in Farmington Hills Exp 401K & benefits Fax resume to (734) 927 4322

506 Help Wanted-Medical

LPN DAYS & AFTERNOONS \$2 2nd shift differential 50 Weekend Differential

HEARTLAND HEALTH CARE CENTER GEORGIAN BLOOMFIELD is an upscale 200 bed skilled nursing rehab and sub acute care facility We are looking for full time Nurse Supervisors on our afternoons shift for our fast paced rehabilitation unit

Our Center Features • A full time physician on site • A diverse medical environment • IV's TPN and wound care • A stable management team • An excellent survey history • Opportunities for advancement

The successful candidate will possess superior organizational skills and the ability to serve as a role model for our patient centered philosophy of care As part of the HCR team our employees enjoy comprehensive benefits including medical dental life company matching 401K and tuition assistance

Please call for an interview 248-645 2900 fax resume or email return to HRC Georgian Bloomfield 3175 N Adams Road Bloomfield Hills MI 48304 Fax 248-433 1415

LPN Full time for afternoons RN Part time for mornings Bloomfield Hills MI 48304 Fax 248-433 1415

LPN Part time for busy allergy practice 15 20 hrs/week Farmington Hills & Livonia locations (248) 851 6657

Contingent Positions Now Available Fax resume to 248-477 2888 Farmington Health Care Center 34225 Grand River Farmington Hills

MAMMOGRAPHER PART TIME Responsible dependable cert in mammography tech needed for busy radiology office located in Wayne Fax resume to (734) 326 3999 or mail to 4491 Venoxy Rd Wayne

MEDICAL ASSISTANT For busy internal medicine office Experienced only Full time Please contact office manager (248)927 4322

MEDICAL ASSISTANT/PRN/RN Medical examiners needed to perform mbol medical evaluation Must have good phlebotomy and related radiology skills plus mileage pay Day and afternoon shifts available Fax resume to (248)544-1971

FRONT DESK FULL TIME Chiropactic or retail experience Will train Farmington Hills Call 248 213 5182

FRONT DESK/RECEPTIONIST BUSY INTERNAL Medicine office accepting applications for full time front desk position Experience preferred Fax resume to Clinical Manager (734) 981 0653

FRONT OFFICE HELP Full time needed for Westland office Fax resume to 734-728 1400

FRONT OFFICE Looking for career minded individual to work at alternative health care practice Competitive experience preferred 401K & benefits Send resume to 39955 W 10 Mile #112 Novi MI 48375 Attn Pam

HOME HEALTH AIDE Sat 8 4pm shift Private residence Commerce Twp Leave message (248) 407 7523

INEXPERIENCED? AGGRESSIVE? OVERPAID? We will train you to earn 70K+ your first year One of the largest companies in its field is looking for reps that are career oriented Confirmed appointments best product line available Call Mr Wright (734)762 9090

Infant Support Specialist Home Visiting Nurse Corner Health Center will hire an RN to provide home based assessment & parenting education Full time with benefits RN plus 2 yrs experience infant mental health background a must apply to Beverly Johnson Corner Health Center 47 N Huron St Ypsilanti MI 48197 Fax 734-484-3100 EOE

INSTRUMENT TECHNICIAN/STERILE PROCESSING Leading medical processor in the Westland area has an opening for person with laparoscopic instrument processing skills Instrument technician certification and/or 2 plus years experience necessary Keep accurate records follow SOP's Opportunities available for lead positions FDA regulated environment Pay commensurate with experience good benefits Fax resume including salary history to 734-595 7644 or mail to SRI/SURGICAL EXPRESS 38120 Webb Drive Westland MI 48185 EOE

INSURANCE CLERK Part time Experience helpful in claim follow up Benefits available Call Sherry 248-477 8939

Large and busy Royal Oak Oncology practice has openings for the following positions:

* MEDICAL ASSISTANT Full time experience required

* REGISTERED NURSE Full time outpatient oncology experience required

* MEDICAL LAB TECHNICIAN Full time

* INSURANCE SPECIALIST Full time experience verifying insurance benefits Some data entry and phone calls

We offer a competitive salary and generous benefit package that includes profit sharing If you are looking for a challenging and rewarding position send your resume to Human Resources at (248) 551 6909

Medical Biller / Data Entry Needed for orthopedic surgeons office in Novi Fax resume to Janet (248) 969 1788

Medical Assistant/ LPN An established Family Practice office in Plymouth is seeking a full time Medical Assistant/LPN Duties include providing professional clinical care to patients following established standards and practices Certified M of LPN required We offer a competitive salary with an excellent benefit package Interested applicants may send their resume to Nancy Kelley 390 W Ann Arbor Trail Suite 207 Plymouth MI 48170 or fax to (734) 453 8721 www.ihcare.com

Medical Biller Experience required Excellent benefits Competitive salary Friendly atmosphere Plymouth area Call Maria S 734-453 6970

Medical Receptionist / Data Entry Needed for orthopedic surgeons office in Novi Fax resume to Janet (248) 969 1788

Medical Receptionist Full time position for busy physical therapy office in Farmington Hills Exp 401K & benefits Fax resume to (734) 927 4322

Medical Receptionist Full time position for busy physical therapy office in Farmington Hills Exp 401K & benefits Fax resume to (734) 927 4322

Medical Receptionist Full time position for busy physical therapy office in Farmington Hills Exp 401K & benefits Fax resume to (734) 927 4322

Medical Receptionist Full time position for busy physical therapy office in Farmington Hills Exp 401K & benefits Fax resume to (734) 927 4322

Medical Receptionist Full time position for busy physical therapy office in Farmington Hills Exp 401K & benefits Fax resume to (734) 927 4322

Medical Receptionist Full time position for busy physical therapy office in Farmington Hills Exp 401K & benefits Fax resume to (734) 927 4322

Medical Receptionist Full time position for busy physical therapy office in Farmington Hills Exp 401K & benefits Fax resume to (734) 927 4322

Medical Receptionist Full time position for busy physical therapy office in Farmington Hills Exp 401K & benefits Fax resume to (734) 927 4322

THE OBSERVER & ECCENTRIC PRESENTS

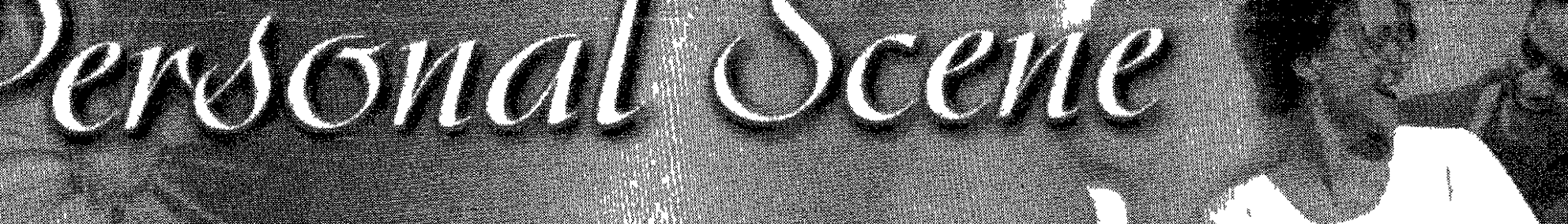

Respond to these exciting area singles by calling

Respond using your Visa/Mastercard call

1-900-454-5566

1-800-630-2941

(\$4.38 first minute, each add'l minute .18 or older)



(\$2.49/minute)

52 NEW ADS!

WOMEN seeking MEN logo

Call 1-900-454-5566 \$4.38 first minute, \$2.19 each add'l minute

LADY OF PASSION Young sexy energetic weight b brown eyes looking for white gentleman who is not afraid of his feelings a nice one no games for long term relationship Wayne County BOX 15707

UNIQUE VEGETARIAN Divorced female 57 110 lbs. happy and degrades loves yoga living food preparation culinary arts grad in search of a great connection open hearted communicative who a loving self aware healthy love of dance music and the beautiful world are a plus Oakland County BOX 36076

ARE YOU LONELY? Would you like to meet someone with a great personality non-egotistical non drinker a person of good character integrity reputation? Who at all believes in friendship companion and true love seeking tall male 55 to 65 Oakland County BOX 36080

STAND OUT IN CROWDS 59 female brunette attractive seeking a male 59 or taller 50 or older for bus trips theater dancing and more BOX 15373

SINGLE AGAIN Single white female 49 53 145 lbs average on the outside but on the inside Can get by on my own but would like to start sharing again You must be a non smoker and likes cats Oakland County BOX 31936

DOWN RIVER FEMALE Divorced white female 54 140 lbs would like to meet a tall white gentleman 54 to 60 who is interested in a serious relationship possible long term relationship no head games Wayne County BOX 31942

GOOD HEARTED FEMALE Seeking good hearted white male 39 to 47 teddy bear to average build who a caring and trusting romantic and employed no games no de non smoker social drinker enjoys movies music sports cards dining friends/family in the Down River area Wayne County BOX 31953

ARE YOU Looking to someone special who a sincere honest and fun loving could be me I am a fit and toned to do almost anything West Side area Lets talk Wayne County BOX 36084

OUTDOORS GAL Single female 42 59 b brown hair blue eyes average build pppionate haw do wnk Lkes being outdoors a the time BOX 2170

LOVE TO LAUGH Single white female 26 55 175 lbs hazel eyes golden brown hair Seeking a single white male 25 to 40 for casual dating and a possible long term relationship Seeking someone who enjoys dining and more BOX 12176

IT'S IN THE STARS Divorced female 42 58 dependents 53 145 lbs brown hair blue eyes Enjoys outdoors animals fishing water sports concerts sunbathing Harley riding Looking for someone with similar interests to begin a warm and wonderful relationship p BOX 12241

END MY SEARCH Single female 20 60 outgoing mother of two Enjoys going to movies dancing Looking for a compatible male to share these interests BOX 15375

MAKE THE CALL Attract female 59 135 classv long ng 54 128 lbs brown hair/eyes enyoing outdoors travel sunbathing Seeking a single white male 55-68 BOX 26942

YOU ARE MY SUNSHINE Single white female 38 average height/weight reddish brown hair green eyes two children Seeking intelligent single white male 45 to 55 good natured easy to get along with for a long term relationship BOX 29862

GET TO KNOW ME Single mother of one 34 plus sized shy at first Enjoys movies dining long walks children animals Looking for single gentleman 32-44, to start out as friends BOX 29885

MEDICAL FIELD Divorced female 56 165 lbs brown hair brown eyes likes walking and music Looking for a divorced man who is fun exciting outgoing person who enjoys fun to be with financially secure BOX 29880

HEAVEN SENT Single white female 43 57 153 lbs nurse great smile attractive caring compassionate warm two children Seeking a carpenter 42 48 yrs old financially secure warm and cuddly Enjoys camping movie plays lots of hugs and kisses BOX 29919

A LADY OF CLASS Vivacious upbeat, very attractive blonde female a professional 57 115 lbs upper 60s seeking soul mate companion part 60s a professional for dating possible long term relationship Call me and see what life has in store for us BOX 35998

SEEKING ITALIAN Petite white female 63 51 128 lbs brown hair and eyes non-smoker attractive talkative good sense of humor Seeks gentleman 60 to 66 non-smoker sharing the things in life we both enjoy especially traveling BOX 36033

SEEKING RELATIONSHIP Attractive slender tall lady of 55 warm hearted cerebral somewhat a quiet home body a smoker Seeking a gentleman 55 to 69 intelligent tall poit fruitful a smoker who enjoys dining and conversation on Oakland County BOX 36077

MOTOWN GAL Looking for a kind sincere single or divorced male 48 to 60 non smoker for long term monogamous relationship I am 51 yr old divorced female love Motown music and classic cars believe in romance and enjoy simple pleasures Down River area BOX 14471

TOUCH OF CLASS For a sexy attractive classy outgoing divorced white female 55 130 lbs dark hair pretty eyes Seeks top notch tall white male 50 plus to hook fun and special moments together Your cost one phone call Oakland County BOX 36059

I HAVE ELAN Eclectic attractive older roman to qualify lady enjoys most music dancing golf tennis boating sports and theater Seeks special non smoking gentleman over 50 and 510 plus that is honest loyal and fun Oakland County BOX 36061

ATTENTION BILL You responded to my ad mailbox #33724 I did not get your phone n mber can you please call back Wayne County BOX 19502

CUTE AND CLASSY 40s 64 slim degreed non smoking fun athletic adventurous divorced white professional female with brown hair and big blue eyes Seeking intelligent degreed slim non smoking gentleman 42 to 52 for water sports dining rollerblading, travelling and long term relationship Oakland County BOX 26985

DOWN RIVER FEMALE Single white female 57 110 lbs intelligent proportionate brown hair hazel eyes Enjoys horseback riding swimming dining out movies seeking a tall white male 54 or older for a possible relationship Wayne County BOX 33719

TALL & INTELLIGENT Fit young looking 45 romantic Christian professional lady very attractive optimistic well educated Enjoys the good life social nature hiking travel and din ing Seeking soul mate tall thin attractive honest affectionate positive for making humor successful with values BOX 35946

SOMETHING ABOUT ME Charming single white female healthy 39 54 135 lbs blonde/brown bright attractive U of M grad professional employed enjoys culture nature world travel friends Seeking non smoking attractive professional man 30s cats or kerate obsession please Oakland County BOX 36071

SIMPLY IRRESISTIBLE Pretty petite passionate divorced white female 42 110 lbs non smoking single white male 35 for dating and relating Lets create sparks and watch them fly BOX 26392

QUALITY QUALITY Seeking a sincere honest non games played non-smoking social drinking single white male by a divorced white female 54 who likes to do almost everything Looking for friends p companion ship something long term West side Wayne County BOX 26333

HONESTY + BASEBALL Single white Christian professional female 46 attractive ve with a heart of gold great cook Enjoys quiet times and movies Looking for a well groomed white male a non smoker with Christian values Wayne County BOX 26262

BEAUTIFUL Intelligent classy lady 50s loves travel boating golf tennis walks on the beach and romantic dinners searching for a gentleman with similar interests BOX 26072

NO GAMES Single white female 27 in search of a single white male 29-39 fit and healthy independent single family oriented enjoys a wide variety of interests like music being by the water reading and more Looking for a relationship Wayne County BOX 26997

IM YOUR LADY Attractive white divorced 45 52 138 lbs female blonde blue eyes intelligent fun swimming movie music and dining out Seeks white male 40-50 slim to med um build 45-55 non smoker cooks and drinker affectionate and sincere for a meaningful relationship n Garden City BOX 20599

SONGS FROM THE HEART Divorced white female 47 57 blonde/brn vivacious passionate Christian church musician Seeks white male 40-50 who is intelligent articulate romantic and honest with a passion for Oakland County BOX 27014

EQUAL PARTNERS White female 49 red hair and blue eyes 57 60s smoke Enjoys a good movie garden and trying new things Seeking male 45 to 55 honest o 1 end who plays pool and much more long term relationship BOX 30179

ADVENTURE AWITS Divorced white female 50 early 50s hazel eyes independent seek educated male 50 or older who enjoys art museums travel theater fine dining jacking sea market my ad today BOX 36243

CIRCLE THIS AD Single white female 51 emotional ly/fnancially secure likes being walking and dancing Seeking a single black male 50s with sense of humor and a similar interests BOX 30259

OUTGOING GAL Single black female attractive 62 57 height/weight proportionate Seeking non smoker social drinker wanting to enjoy dining out evenings at home what he has to offer BOX 30259

LET'S GO OUT Single female 58 28 135 lbs short brown hair a brown eyes open minded sense of humor adventurous Enjoys movies dancing bowling playing pool and much more Looking for a man to share a similar axis BOX 30263

DIAMOND IN THE ROUGH Single petite size white female hazel eyes independent seek ng down to earth single black male no games must have job/care can enjoy movies dining and long walks communion oation and sense of humor a must Down River SERVICIOUS APPLY Wayne County BOX 31912

NASCAR FAN Lonely rad head 49 57 150 lbs likes doing a lit bit of every thing from travelling up North on week ends quiet Sundays watching NASCAR on televis on Looking for down to earth guy 45 to 55 who enjoys the same for companion ship Wayne County BOX 31912

LET'S GET TOGETHER Single black female 24 51 135 lbs Enjoys movies bike riding bowling and sports Seeking male 30-45 with similar interests for dating and possible relationship Wayne County BOX 31922

QOLF PARTNER WANTED Widowed white female 55 seeking kind gentle golf partner with sense of humor I like travel fine dining and Florida in the winter If you are widowed/single lets hit some balls and see if we can be a team Wayne County BOX 35932

GEMINI GIRL Single white female 47 slender blonde hair hazel eyes enjoys golf swimming boating people Looking for a single white male 42 53 who is genuine down to earth stable for dating possible long term relationship p Wayne County BOX 36938

MESSAGE THERAPIST Single white female 48 59 6'0" divorced seeking a single white male 35 plus who is outgoing enjoys life and opt to sitc about the future Summer is here lets get together BOX 36035

LET'S SEE A MOVIE 33 yr old single white female blonde hair blue eyes 58 non smoker who enjoys working out movies etc Seeking 29-39 single white male to spend time with Wayne county BOX 36099

NAME AND NUMBER Single female 57 blonde/blue medium build Looking for tall white male 50 to 62 non smoker who likes dancing walks travel time with family picnics music BOX 12047

CURE FOR LONELINESS Attractive black female early 50s dark brown skin 53 average weight no dependents employed seeks honest cat ng black or Hispanic a male who is employed and has a car BOX 12101

SOMETHING YOU D LIKE Independent blonde full figured 57 20 seeks confident honest male 20 to 30 to be friends first, and nurture a possible relationship BOX 12103

LIFE'S PLEASURES Divorced white female 43 59 170 lbs blonde hair and blue eyes full figured Christian vibrant happy Many interest cooking reading gardening garage sales classic cars walks by the water and more Seeking a friend and companion for a possible relationship p BOX 12103

ARE YOU THE ONE? Young Amer can business owner seeking a 29 to 33 yr old professional American who's spiritual responds like passionat fit and healthy for a friendship first BOX 12179

MY KIND OF MAN Divorced black female 47 seeks black male 45 to 58 to enjoy life and work Seeking an honest man who is a good cook and a good father and boating for a possible long term relationship BOX 15229

LIFE'S BETTER SHARED White female full figured blonde hair and green eyes seeking a white male 39 to 45 a sincere non est for a long term relationship p Oakland County BOX 15225

LET'S GET SERIOUS Single white female late 40s red hair tall Looking for black male for fun sports music a cooking romantic walking hand held gavel pass on BOX 15262

LOVELY BUT LONELY Tall slender attractive romantic fun lady seeks honest loyal romantic who is a good father and boating for a possible long term relationship p BOX 15273

WEEKENDS ARE BACK 26 yr old black female 54 125 lbs hard working Seeking an honest understanding non smoking energetic male race un important who enjoys weekends children boating and romance BOX 30208

LET'S GO OUT White female fit brunette 38 yrs old attractive well educated articulate non-smoker Enjoys gardening concerts and more Seeking a non smoking tall male 38 to 45 professional with similar interests BOX 30212

MIAMI STYLE White divorced male 49 58 178 lbs never married 3 grown children who enjoys candlelight dining and loves Seeks best friend and loves somebody seeking black male 49 to 52 for dating and possible relationship Wayne County BOX 37024

30 SOMETHING Degreed single Christian black female 35 attractive with Hispanic descent looks attractive m nded and loves Seeks best friend Christian professional white male healthy, degreed 510 plus, 30 to 37 preferably slim Macon nb County BOX 27028

COUNTRY GIRL Divorced white lady non-smoker non drinker I like horseback riding has own horses Enjoys camping walking boating flea markets etc to 65 with a similar interest Monroe County BOX 27030

LOVELY BUT LONELY Tall slender attractive romantic lady seeks honest loyal romantic flexible gentleman that's 55 plus over 510 and fun to be with Lets start as friends first Oakland County BOX 27034

FIND YOUR FUTURE Single white female 37 looking for tall smart nice moral man who enjoys time in family and friends Friendship seeking long relationship with ove and a lasting relationship p BOX 30187

WEEKENDS ARE BACK 26 yr old black female 54 125 lbs hard working Seeking an honest understanding non smoking energetic male race un important who enjoys weekends children boating and romance BOX 30208

LET'S GO OUT White female fit brunette 38 yrs old attractive well educated articulate non-smoker Enjoys gardening concerts and more Seeking a non smoking tall male 38 to 45 professional with similar interests BOX 30212

MIAMI STYLE White divorced male 49 58 178 lbs never married 3 grown children who enjoys candlelight dining and loves Seeks best friend and loves somebody seeking black male 49 to 52 for dating and possible relationship Wayne County BOX 37024

30 SOMETHING Degreed single Christian black female 35 attractive with Hispanic descent looks attractive m nded and loves Seeks best friend Christian professional white male healthy, degreed 510 plus, 30 to 37 preferably slim Macon nb County BOX 27028

COUNTRY GIRL Divorced white lady non-smoker non drinker I like horseback riding has own horses Enjoys camping walking boating flea markets etc to 65 with a similar interest Monroe County BOX 27030

LOVELY BUT LONELY Tall slender attractive romantic lady seeks honest loyal romantic flexible gentleman that's 55 plus over 510 and fun to be with Lets start as friends first Oakland County BOX 27034

FIND YOUR FUTURE Single white female 37 looking for tall smart nice moral man who enjoys time in family and friends Friendship seeking long relationship with ove and a lasting relationship p BOX 30187

WEEKENDS ARE BACK 26 yr old black female 54 125 lbs hard working Seeking an honest understanding non smoking energetic male race un important who enjoys weekends children boating and romance BOX 30208

LET'S GO OUT White female fit brunette 38 yrs old attractive well educated articulate non-smoker Enjoys gardening concerts and more Seeking a non smoking tall male 38 to 45 professional with similar interests BOX 30212

MIAMI STYLE White divorced male 49 58 178 lbs never married 3 grown children who enjoys candlelight dining and loves Seeks best friend and loves somebody seeking black male 49 to 52 for dating and possible relationship Wayne County BOX 37024

30 SOMETHING Degreed single Christian black female 35 attractive with Hispanic descent looks attractive m nded and loves Seeks best friend Christian professional white male healthy, degreed 510 plus, 30 to 37 preferably slim Macon nb County BOX 27028

COUNTRY GIRL Divorced white lady non-smoker non drinker I like horseback riding has own horses Enjoys camping walking boating flea markets etc to 65 with a similar interest Monroe County BOX 27030

NEW BEGINNINGS Single white female 47 54 178 lbs never married 3 grown children who enjoys candlelight dining and loves Seeks best friend and loves somebody seeking black male 49 to 52 for dating and possible relationship Wayne County BOX 37024

I AM YOUR MAN Hardworking divorced white male 48 58 175 lbs Seeking a fun loving, easy going intelligent pretty white female n her mid 40s for companionship p and possible long term relationship p Redford area Wayne County BOX 25974

RING MY BELL Divorced white male 49 59 175 lbs Seeking a woman that wants a long term relationship Single male 23 looking for a beautiful young lady for fun and romance nothing serious right now BOX 29815

WAITING ON YOUR CALL Single male 34 56 170 lbs brown/blue easygoing fun loving honest caring Likes working on cars flea markets motorcycle the outdoors boating nature Seeking a single female with a nice personal v BOX 29843

GOOD SENSE OF HUMOR Divorced white male 49 58 182 lbs enjoys gray and brown hair secure romantic honest with good morals Loves children sports music and long walks in the woods Seeking nice nature loving single female 40-52 friends first possible long term relationship Wayne County BOX 31910

IMA GENTLEMAN Looking for a slender attractive lady 50 to 58 for a permanent relationship I am widowed well built healthy attractive active and outgoing I am 62 going on 40 and handsome Please call my voice gretd Dearborn area I answer your call Wayne County BOX 33683

DOWN RIVER MALE Single white male 50 58 185 lbs seeking female weight/height proportionate 58 160 lbs classy east who enjoys movies live bands dancing moonlight walks No games for possible long term relationship Wayne County BOX 33716

ATTRACTIVE SWM 33 Professional on down to earth and fun outgoing white male 48 160 lbs female who enjoys life and likes to have fun Oakland County BOX 36054

MORE THAN FRIENDS Attract single white male 40s well educated and honest enjoys travel photography concerts and the outdoors Seeking a sincere lady with a sense of humor Oakland County BOX 36054

HONEST AND CARING 33 yr old white professional divorced male honest caring Enjoys long walks boating fishing and more Seeking a female who is honest and care BOX 32266

THE ONE FOR YOU Late 70s looks 60 w/dowed white male 58 190 lbs non smoker Enjoys travel dining out golf and more If you interested in me call we're a match call me BOX 15383

SEEKING MS RIGHT 51 yr old professional white male 5'10" 175 lbs brown hair blue eyes slender likes sewing woodworking Seeking a female 35-45 divorced rver area Wayne County BOX 31925

ONCE UPON A STAR Intense appeal single white male helpful and romantic Seeks nice girl 30-50 who is fun outgoing for a long term relationship Oakland County BOX 31901

ABOVE AVERAGE GENT Single white male m d 40s enjoys travel music old cars photography home decorating etc Looking for an above average lady to partner with Wayne County BOX 31929

SEEKING MS RIGHT Single white female 49 58 175 lbs brown hair blue eyes slender likes sewing woodworking Seeking a female 35-45 divorced rver area Wayne County BOX 31925

ONE DAY AT A TIME Single white male 47 57 150 lbs skill trade Ford worker with Herpes likes boating camping weekend getaways looking for a single female 32 to 47 who is fun outgoing and has a good personality and sense of humor Wayne County BOX 31931

HERE'S A SURPRISE 48 good shape nice looks Enjoys outdoors hiking boating parties and beaches Seeks nice gal to share leisure time activities w Oakland County BOX 36057

READY FOR LOVE Single male 27 61 175 lbs blonde hair blue eyes slender build Seeking a tall female who loves to have fun likes to laugh and play likes fast bikes BOX 15337

EASYGOING GUY White w/dowed professional male 46 56 175 lbs brown hair blue eyes easygoing fun loving caring honest Likes boating swimming fishing the beach Age/race unimportant BOX 15354

LET'S GET TOGETHER Single white male 28 51 215 lbs dark brown hair hazel eyes smoker Loves outdoors rollerblading long walks movies Looking for a single white female 24-35 with similar interests BOX 25290

YOU KNOW WHAT TO DO Single white male 67 217 lbs physically fit dark complexion blue eyes brown hair a dominant Looking for a female 18-44 adventurous spontaneous loves outdoors BOX 25665

AT THE GYM Single male 21 63 220 med um large build Likes working out movies concerts tall Looking for a single female with a good sense of humor for a casual relationship p with long term BOX 25885

SEEKS DATE Divorced white male early 50s dark hair/blue eyes seeks wid oved divorced white female 38 to 54 for dating and possible long term relationship if you're looking for the one woman man that's me Wayne County BOX 26991

ROMANTIC ITALIAN Handsome divorced white professional male 47 6 195 lbs very fit financially secure Looking for a classy female in shape w/ blonde or red hair blue or green eyes age not important BOX 31882

PASSIONATE PILOT Retired airline pilot financially secure with a male very good looking late 60s 59 161 lbs good sense of humor very nice guy Like doing most everything with right gear Seeking very slender healthy honest woman with very good shape down river area Wayne County BOX 31888

DREAMS/DISILLUSIONS Really based single white male kinda cute energetic cooperative willing to compromise new Seeks an interesting lady 33 to 49 for a possible relationship p BOX 36101

I AM YOUR MAN Hardworking divorced white male 48 58 175 lbs Seeking a fun loving, easy going intelligent pretty white female n her mid 40s for companionship p and possible long term relationship p Redford area Wayne County BOX 25974

RING MY BELL Divorced white male 49 59 175 lbs Seeking a woman that wants a long term relationship Single male 23 looking for a beautiful young lady for fun and romance nothing serious right now BOX 29815

WAITING ON YOUR CALL Single male 34 56 170 lbs brown/blue easygoing fun loving honest caring Likes working on cars flea markets motorcycle the outdoors boating nature Seeking a single female with a nice personal v BOX 29843

GOOD SENSE OF HUMOR Divorced white male 49 58 182 lbs enjoys gray and brown hair secure romantic honest with good morals Loves children sports music and long walks in the woods Seeking nice nature loving single female 40-52 friends first possible long term relationship Wayne County BOX 31910

IMA GENTLEMAN Looking for a slender attractive lady 50 to 58 for a permanent relationship I am widowed well built healthy attractive active and outgoing I am 62 going on 40 and handsome Please call my voice gretd Dearborn area I answer your call Wayne County BOX 33683

DOWN RIVER MALE Single white male 50 58 185 lbs seeking female weight/height proportionate 58 160 lbs classy east who enjoys movies live bands dancing moonlight walks No games for possible long term relationship Wayne County BOX 33716

ATTRACTIVE SWM 33 Professional on down to earth and fun outgoing white male 48 160 lbs female who enjoys life and likes to have fun Oakland County BOX 36054

MORE THAN FRIENDS Attract single white male 40s well educated and honest enjoys travel photography concerts and the outdoors Seeking a sincere lady with a sense of humor Oakland County BOX 36054

HONEST AND CARING 33 yr old white professional divorced male honest caring Enjoys long walks boating fishing and more Seeking a female who is honest and care BOX 32266

THE ONE FOR YOU Late 70s looks 60 w/dowed white male 58 190 lbs non smoker Enjoys travel dining out golf and more If you interested in me call we're a match call me BOX 15383

SEEKING MS RIGHT 51 yr old professional white male 5'10" 175 lbs brown hair blue eyes slender likes sewing woodworking Seeking a female 35-45 divorced rver area Wayne County BOX 31925

ONCE UPON A STAR Intense appeal single white male helpful and romantic Seeks nice girl 30-50 who is fun outgoing for a long term relationship Oakland County BOX 31901

ABOVE AVERAGE GENT Single white male m d 40s enjoys travel music old cars photography home decorating etc Looking for an above average lady to partner with Wayne County BOX 31929

SEEKING MS RIGHT Single white female 49 58 175 lbs brown hair blue eyes slender likes sewing woodworking Seeking a female 35-45 divorced rver area Wayne County BOX 31925

ONE DAY AT A TIME Single white male 47 57 150 lbs skill trade Ford worker with Herpes likes boating camping weekend getaways looking for a single female 32 to 47 who is fun outgoing and has a good personality and sense of humor Wayne County BOX 31931

HERE'S A SURPRISE 48 good shape nice looks Enjoys outdoors hiking boating parties and beaches Seeks nice gal to share leisure time activities w Oakland County BOX 36057

READY FOR LOVE Single male 27 61 175 lbs blonde hair blue eyes slender build Seeking a tall female who loves to have fun likes to laugh and play likes fast bikes BOX 15337

EASYGOING GUY White w/dowed professional male 46 56 175 lbs brown hair blue eyes easygoing fun loving caring honest Likes boating swimming fishing the beach Age/race unimportant BOX 15354

LET'S GET TOGETHER Single white male 28 51 215 lbs dark brown hair hazel eyes smoker Loves outdoors rollerblading long walks movies Looking for a single white female 24-35 with similar interests BOX 25290

YOU KNOW WHAT TO DO Single white male 67 217 lbs physically fit dark complexion blue eyes brown hair a dominant Looking for a female 18-44 adventurous spontaneous loves outdoors BOX 25665

AT THE GYM Single male 21 63 220 med um large build Likes working out movies concerts tall Looking for a single female with a good sense of humor for a casual relationship p with long term BOX 25885

SEEKS DATE Divorced white male early 50s dark hair/blue eyes seeks wid oved divorced white female 38 to 54 for dating and possible long term relationship if you're looking for the one woman man that's me Wayne County BOX 26991

ROMANTIC ITALIAN Handsome divorced white professional male 47 6 195 lbs very fit financially secure Looking for a classy female in shape w/ blonde or red hair blue or green eyes age not important BOX 31882

PASSIONATE PILOT Retired airline pilot financially secure with a male very good looking late 60s 59 161 lbs good sense of humor very nice guy Like doing most everything with right gear Seeking very slender healthy honest woman with very good shape down river area Wayne County BOX 31888

LOVELY BUT LONELY Tall slender attractive romantic lady seeks honest loyal romantic flexible gentleman that's 55 plus over 510 and fun to be with Lets start as friends first Oakland County BOX 27034

FIND YOUR FUTURE Single white female 37 looking for tall smart nice moral man who enjoys time in family and friends Friendship seeking long relationship with ove and a lasting relationship p BOX 30187

WEEKENDS ARE BACK 26 yr old black female 54 125 lbs hard working Seeking an honest understanding non smoking energetic male race un important who enjoys weekends children boating and romance BOX 30208

LET'S GO OUT White female fit brunette 38 yrs old attractive well educated articulate non-smoker Enjoys gardening concerts and more Seeking a non smoking tall male 38 to 45 professional with similar interests BOX 30212

MIAMI STYLE White divorced male 49 58 178 lbs never married 3 grown children who enjoys candlelight dining and loves Seeks best friend and loves somebody seeking black male 49 to 52 for dating and possible relationship Wayne County BOX 37024

30 SOMETHING Degreed single Christian black female 35 attractive with Hispanic descent looks attractive m nded and loves Seeks best friend Christian professional white male healthy, degreed 510 plus, 30 to 37 preferably slim Macon nb County BOX 27028

COUNTRY GIRL Divorced white lady non-smoker non drinker I like horseback riding has own horses Enjoys camping walking boating flea markets etc to 65 with a similar interest Monroe County BOX 27030

LOVELY BUT LONELY Tall slender attractive romantic lady seeks honest loyal romantic flexible gentleman that's 55 plus over 510 and fun to be with Lets start as friends first Oakland County BOX 27034

FIND YOUR FUTURE Single white female 37 looking for tall smart nice moral man who enjoys time in family and friends Friendship seeking long relationship with ove and a lasting relationship p BOX 30187

WEEKENDS ARE BACK 26 yr

Classified Ad Index

CLASSIFICATION	NUMBER
■ Employment	600-699
■ Announcements	600-690
■ Merchandise	700-754
■ Autos/RVs	800-878
■ Autos By Make	834-874
■ Boats/Motors	802
■ Motorcycles/Mini Bikes	807
■ Trucks	822

Our complete index can be found in the Real Estate section

TO PLACE AN AD

CALL TOLL FREE

1 800-579-SELL (7355)

FAX YOUR AD (734) 953-2232

Walk-In Office Hours:
Monday - Friday 8:30 am - 5 pm
After Hours: Call (734) 591-0900 to use our 24-Hour Voice Mail System

Deadlines: For placing, cancelling or correcting of ads.

Publication Day	Deadline
Sunday	5:30 P.M. Fri.
Sunday Real Estate	5:30 P.M. Thurs.
Thursday	6:00 P.M. Tues.
Thursday Real Estate Display	3:00 P.M. Mon.

You can view the Observer & Eccentric Automotive Classifieds on the web at:

www.observer-eccentric.com

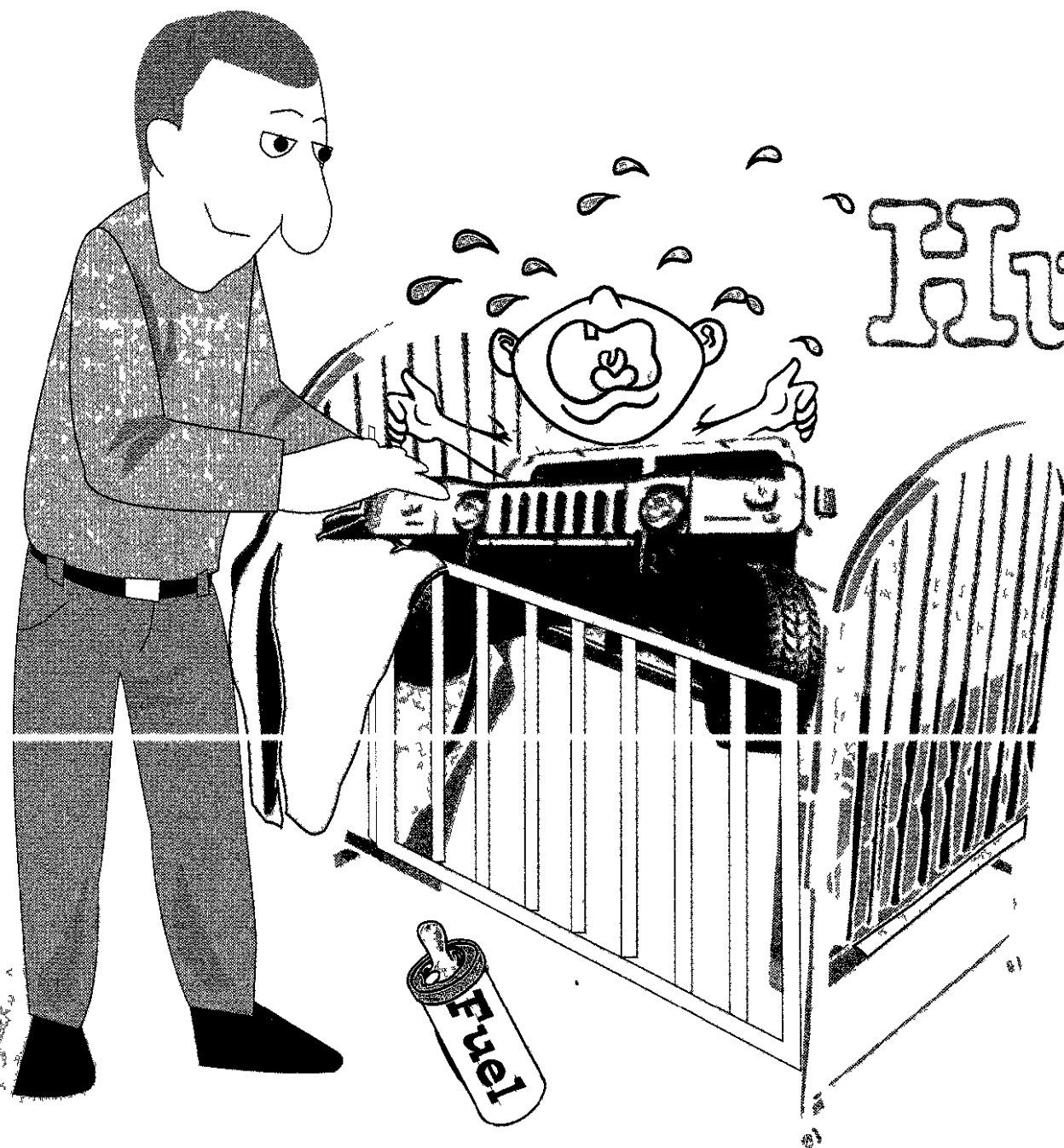

It's a Hummer-dinger!



GENERAL HUMMER



By J. ERIC ECKARD
© AutoWire Net

Buying a Hummer is like having a baby. You can never afford one, but they're fun to look at and play with. And they're also loud,

uncomfortable and by the end of the first month, the newness wears off. So, why do couples continue to have babies, and why does the AM General Hummer continue to be a hot item for the rich and famous? I guess there's nothing like holding a baby that you helped create. And I guess there's nothing like barreling down the highway in basically the same vehicle that Arnold Schwarzenegger, Karl Malone, Andre Agassi and thousands of soldiers drive

The Hummer is the civilian version of the Humvee, which is the vehicle of choice for the United States armed forces. I drove a four-door hardtop, one of four models available to the general public.

While the military version of this go-anywhere, do-anything monster offers just what's necessary for troops to do battle on any kind of terrain, the civilian

Please see HUMMER, H2

BILL BROWN FORD

FACTORY AUTHORIZED CLEARANCE

2001 MUSTANG GT



Automatic, air, power windows & locks, speed control, tilt CD [2 at this price.]

A-PLAN 36 MONTH LEASE WITH RENEWAL	10% Down \$2385	Per Month \$282**	WAS \$23,855 A-PLAN \$18,989 OFF LEASE BUY
	Zero Down	Per Month \$360**	

2001 FOCUS ZX3



Automatic transmission, air speed control & tilt wheel, power windows, power mirrors, AM/FM CD, power locks, rear defrost [3 at this price.]
Stock #13353

A-PLAN 36 MONTH LEASE WITH RENEWAL	10% Down \$1373	Per Month \$184**	WAS \$15,360 A-PLAN \$11,839 OFF LEASE BUY
	Zero Down	Per Month \$226**	

2001 WINDSTAR LX



Four door, air, power locks, power windows, power mirrors, AM/FM cassette/CD, remote keyless entry, floor mats, electric rear defrost
Stock #15220

A-PLAN 36 MONTH LEASE WITH RENEWAL	10% Down \$2262	Per Month \$195**	WAS \$25,805 A-PLAN \$17,466 WINDSTAR TO WINDSTAR OFF LEASE BUY
	Zero Down	Per Month \$260**	

#1 Windstar Dealer in the USA

SOLAR ECLIPSE CONVERSION



Ford's #1 VAN CONVERTER!

Automatic, dual air, power windows, power locks, speed control, tilt wheel, flip down TV/VCP, rear CD
Stock #14330
— WAS \$33,460 —

FORD A-PLAN PRICE **\$23,660***
OFF LEASE BUY

A-PLAN 36 MONTH LEASE WITH RENEWAL	10% Down \$2785	Per Month \$381**
	Zero Down	Per Month \$468**

2001 EXPLORER SPORT 2 DOOR



Convenience Group, Premium Sport Group, limited slip axle, Comfort Group, power windows, power locks, power mirrors, cruise control, tilt wheel, dual media radio [15 at this price.]

A-PLAN 24 MONTH LEASE WITH RENEWAL	10% Down \$2208	Per Month \$229**	WAS \$25,400 A-PLAN \$16,985 OFF LEASE BUY
	Zero Down	Per Month \$322**	

2001 EXPEDITION XLT



Sport Appearance
5.4L V8, Lim Slip, comfort conv group, trailer tow, 6 disc, power windows & locks, speed tilt [3 at this price.]

A-PLAN 24 MONTH LEASE WITH RENEWAL	10% Down \$3216	Per Month \$342**	WAS \$38,160 A-PLAN \$28,450 OFF LEASE BUY
	Zero Down	Per Month \$439**	

2001 F-250 XLT 4x4 SUPERCAB



Auto air, lim slip, power windows & locks, speed control, off road pkg, elec. shift, reverse sensing, aid, cab steps, trailer hitch [3 at this price.]

A-PLAN 24 MONTH LEASE WITH RENEWAL	10% Down \$2790	Per Month \$396**	WAS \$33,050 A-PLAN \$24,939 OFF LEASE BUY
	Zero Down	Per Month \$488**	

#2 Taurus Dealer in the USA

FRIENDS & NEIGHBORS: Your Payments are the Same - With Only an Additional 4% Down!

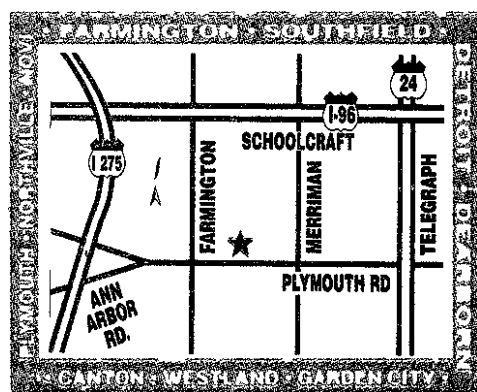

BILL BROWN

1-800-878-2658

Blue Oval Certified
Blue Oval Certification is recognition of the high level of customer satisfaction achieved by this dealership with every purchase, lease and service experience.

MODEL	DOWN PAYMENT	TOTAL DUE AT RECEIPT
2001 F-250	10% Down 0 Down	\$3500 \$608
2001 WINDSTAR	10% Down 0 Down	\$2900 \$550
2001 FOCUS	10% Down 0 Down	\$1700 \$300
2001 EXPLORER	10% Down 0 Down	\$2750 \$500
2001 MUSTANG GT	10% Down 0 Down	\$2950 \$500
2001 SOLAR ECLIPSE	10% Down 0 Down	\$3600 \$750
2001 EXPEDITION	10% Down 0 Down	\$3950 \$650

32222 PLYMOUTH ROAD • LIVONIA • SHOP ONLINE AT FORDAPLAN.COM
Sole price includes assignment of any rebates and incentives to BBF. Don't forget to add tax, title and destination charges. All prior sales and adv. excluded. Includes assignment of rebates. Lease with down payment as shown. 15¢ per mile in excess of 12,000 miles per year. Lessee has no obligation to purchase car at lease end, but may arrange to purchase at a price to be negotiated with BILL BROWN FORD at lease inception. Subject to credit approval. Lessee is responsible for excess wear and tear. Payments do not include monthly use tax to figure total payments. Multiply times number of payments. Pictures displayed may not represent actual sale vehicles. Destination included with lease payments. APR in lieu of rebates. Sale ends 9-14-01.

Hummer from page H1

rendition offers luxuries like a six-disc CD changer, Monsoon stereo system, cruise control, power door locks and remote keyless entry. And when I say monster, I mean monster. The Hummer is nearly 7-feet wide, weighs more than 3 tons and has a whopping 16 inches of ground clearance. It's powered by the General Motors, which recently acquired AM General, 6.5-liter turbo diesel V8 that puts out 190 horsepower at 3,400 rpm with a maximum torque rating of 430 pounds at a surprisingly low 1,800-rpm. Which does wonders for your 0-30 mph times.

If that sounds like the Hummer shortchanges you in the power department, think again. Granted, it takes a week to get from 0-60 mph — actually, 18 seconds — but GM's diesel is a dependable work-horse.

With its slow and methodical approach to the roadway, the Hummer is not a speeding ticket waiting to happen. But with its size, you do have worry about crashing into curbs, fire hydrants and small cars. I did laugh, however, when I read on the Hummer's Web site that "it handles more like a sports car than a truck." I've driven a few sports cars — Porsche, NSX, Corvette — and the Hummer handles nothing like one of these super cars.

Then, there's the exterior. You won't go unnoticed on a city street — and that's the good part about being behind the wheel of the

attention getting Hummer. Although the expansive vehicle looks like it could hold a small army, most of the interior space is taken up by the enormous tunnel that houses the GM 4L80-E 4-speed automatic transmission and transfer case.

With a 16-inch ground clearance and 75-inch total vehicle height, that leaves 59 inches from top to bottom inside the cab. Compare that to a Suburban, which is about the same height, but offers just 10 inches of ground clearance.

But driving it for more than a few days is asking for a sore back and ringing eardrums. And as far as noise goes, I'm real glad AM General installs deluxe heat and sound insulation materials in its Hummers. Any more noise and I think I would have gone deaf.

But I will admit that the four-door hardtop is less noisy than the Hummer wagon, which I drove last year. With a smaller interior, the four-door hardtop has less space than the wagon for the engine and transmission noise to reverberate in.

So, does the lack of comfort make up for the prestige factor? Before I answer that, there are a few other features about the Hummer you should know about. The Central Tire Inflation System allows you to inflate and deflate all four tires, making the Hummer a true off-road killer. If you decide to make a trek across the Mojave or Death Valley deserts, you can deflate the Hummer's tires and glide along effort-

lessly. Or if you get bogged down in a mud hole, inflate them all up again and off you go.

Another cool feature is the 18-gallon auxiliary fuel tank to complement the main 25-gallon tank. Switching from one tank to the other is as easy as flipping a switch — literally. And that's 43 gallons total. Just hope diesel fuel stays under two bucks a gallon. It costs about \$75 to fill the dual tanks on a Hummer today. But if you're rich and famous, who cares?

As you can see, the true attraction to the Hummer should be in its off-road capabilities — not its unique appearance that will draw crowds and comments. Hummer says "most 4x4s" off-road success is 50 percent the machine's capability and 50 percent the driver's skill. The Hummer's prowess is more 90 percent machine and 10 percent driver." I can easily believe that statement because of the Hummer's solid construction and off-road features.

So, is all this enough to make up for the lack of comfort? There has got to be a thousand reasons not to buy a Hummer, just like there are a thousand reasons not to have a baby. But once you have a baby, people look at you differently.

And once you have a Hummer, you can have so much fun in showing off your new toy, that I guess that answers the question.

Observer & Eccentric

EMPLOYMENT

observer-eccentric.com

Your Classifieds Continued From Following Section

This Classification Continued from Page G7

512 Help Wanted-Sales

AUTO SALES CAREER NO EXPERIENCE NECESSARY

(Excellent Opportunity) We are in need of additional Sales People to staff our brand new modern facility. Five people are needed to start work immediately. Our preference is to train all of our Salespeople with no car sales background. All of our new car franchisees are expanding their outstanding growth. All of our Managers come from these positions. We offer five day work week, salary commissions, training, life, health, insurance, paid vacations, new car demo 401K pension security and management opportunity. Apply for this learning position at:

LIVONIA AUTOPLEX
34501 Plymouth Rd
Livonia, or call
(734) 425-5400
for appointment.

512 Help Wanted-Sales

AUTO SALES

New car Salesperson needed for westside Chrysler/Jeep store. We offer Blue Cross/Blue Shield 401K paid vacation and more. Apply in person to Sales Manager, Livonia Chrysler Plymouth 30777 Plymouth Rd between Merriman & Middlebelt Livonia.

512 Help Wanted-Sales

CLASSIFIED SALES DIRECTOR

Metro Times the largest most read weekly in metro Detroit has an immediate opening for a revenue driven results oriented leader to take our department to the next level.

This position reporting directly to the Publisher supervises a staff of 7 classified sales representatives and has responsibility for day to day operations of the department and sales/expense budget. The Classified Sales Director will recruit hire train and motivate a talented sales team.

Ideal candidates for the position will possess classified sales management experience, a proven track record in new business development and strong communication and leadership skills.

Send resume & cover letter to Classified Sales Dir. Position Metro Times 733 S. Antone Detroit MI 48226 Fax 313 961 3802 fax@metrotimes.com

CAREER OPPORTUNITY DAYS

REAL CAREERS FOR REAL PEOPLE

Earn a FREE Laptop computer and a new lucrative career at the same time!

East Side (800) 875 7653 West Side 248 280 0051 for an interview

CAREER SEMINAR

Keller Williams Realty of Livonia presents a free seminar on how to get into real estate and learn what makes Keller Williams Realty stand apart from other Real Estate Companies. Topics include licensing training and evaluating a broker. We offer top commissions and training designed to get you started quickly. Seminar is scheduled for Thursday Sept 20th at 8:30 pm at Keller Williams Realty 31500 Schoolcraft Rd. Call Mike or Jeanine to reserve a seat (734)268 9000

ENTRY LEVEL

Want to try sales? Start by not selling anything we give our products away! Earn \$1000/wk exciting bonus structure and benefits. Call Mr. D (888) 552 8810

512 Help Wanted-Sales

Start a New Career in Real Estate TODAY with Real Estate One...

Find out more information by attending a free one hour Question & Answer Session on Wed September 12th From 6-7:00 p.m. At 20100 Civic Center Dr Ste 216 in Southfield (248)304 2299 OR Call (248)356 7111 For Additional Locations

512 Help Wanted-Sales

EXPERIENCED RECRUITERS

Has the local economy impacted your income? Because we are a national recruitment firm our large diverse client base has allowed us to grow our business even in down economic times. In fact 2001 will be our best year ever.

Find out more about us for a confidential interview call Larry Swider at (248) 932 7770 or Fax (248) 932 7774 or E-mail your resume to JLGCAREER1@AOL.COM 1330 Goldsmith Plymouth MI 48170 Fax (734) 459 0606

512 Help Wanted-Sales

NEW HOME SALES

Top 5 national builder is looking for outstanding individuals to become candidates for salary & commission new home sales positions. Background in insurance office equipment furniture pharmaceutical & real estate sales background or teaching is preferred. Exposure to professional sales training systems is desired. Positions require working some to most weekends. Benefits include major medical, dental vision & 401K plan. Please mail your resume to PO Box 3457 Farmington Hills MI 48333 3457

512 Help Wanted-Sales

OUTSIDE SALES

Local manufacturer of windows & doors currently adding new product lines and expanding sales territories. Now hiring for sales positions in outside sales calling on lumber yards, glass dealers and home improvement contractors throughout Michigan. Ohio and Indiana. Job may require traveling overnight. Competitive pay, weekly or bi-weekly pay, marketing or liberal arts but will consider other degrees. Candidates: Salary bonus and company cars. Call 248 478 7788

512 Help Wanted-Sales

A REAL ESTATE CAREER

Our affiliation with the GMAC Real Estate Network unites two of the most trusted names in the Western Suburbs. Our exclusive real estate services help you become more successful.

- Top notch training
- Marketing tools
- Strategic systems for your client relationships
- Global relocations services
- Financial services

Plus our agents are entitled to GMAC discounts, vendor discounts, group health insurance investments in GM demand notes and many more benefits. We are now looking for 4 more agents to complete our Fall semester training session. Classes are forming now.

Call Darlene Shemanski (734) 451 5400

GMAC REAL ESTATE
1365 South Main St
Plymouth MI 48170

512 Help Wanted-Sales

REAL ESTATE AGENTS

Full & part time. New agents welcome. Plymouth area. Contact John 313 213 0878

512 Help Wanted-Sales

Real Estate Openings

- Free Training
- Prime Location
- Full/Part Time
- Flexible Hours
- Guaranteed Success Program
- Unlimited Income

Century 21
Hartford North (734) 525-9600

512 Help Wanted-Sales

SALES PERSON???

Can you talk to people? Hours drivers waitresses and retail people are very successful at our business. We can put you into that job you have been looking for. Loan officers can exceed \$1000 per week you can too. We will train the right people for this job. Call Keith or David for a personal interview at 800 343 9827

512 Help Wanted-Sales

SALES PERSON

For gourmet food store in Bloomfield Hills. Full benefits. Top pay. Call Peter 248-540 2266

512 Help Wanted-Sales

SALESPERSON

Part time work out of your home \$10/hr + 10% commission. Will train. 248-355 0401

512 Help Wanted-Sales

SALES PERSON

to sell new rebrokers for service companies. Sales person receives all profits. Southfield area (248) 352 4510

512 Help Wanted-Sales

SALESPERSON UPJO

WASTE Services looking for an experienced team member. Base salary + commission. Please send resume to 2450 Middlebelt Rd Westland 48185 or Fax (734) 422-0442

512 Help Wanted-Sales

SALES PERSON

w/ national sales background, immediate opening. flex hrs, good pay, commission & benefits 313-477 9333

512 Help Wanted-Sales

SALES PERSON

30 hours/week for Livonia H&R (Livonia & Brighton) \$8 to \$18 (No taxes) (810) 225 1700

512 Help Wanted-Sales

SALES REPRESENTATIVE

Needed for car wash manufacturer & supply company to call on established customer base in Southeast Michigan. Benefit package. Call for interview (734) 591 7911

512 Help Wanted-Sales

SALES REPS

needed for rapidly expanding local branch of national ice cream distributor. Please be familiar with the Detroit metro area. 313 838-7277

512 Help Wanted-Sales

SALES TO \$35K/yr

Established service company is looking for motivated salesperson with good math aptitude, congenial manner & excellent sales ability. Some heavy lifting. Excellent salary + commission. 401K benefit package. Mail resume apply or fax Attn: Mr. Waters Hagogian Cleaning Services 14000 W. 8 Mile Oak Park MI 48227 Fax 248 545 2521 or Call 248 399 2323

512 Help Wanted-Sales

Serious About a Career in Real Estate?

We are serious about your success.

- Free Pre licensing classes
- Exclusive Success Systems Programs
- Variety of Commission Plans

Coldwell Banker affiliate in the Midwest! Call Sharon McCann at (734) 462-1811 Coldwell Banker Schwitzer Real Estate

512 Help Wanted-Sales

SHOE SALES

Experience needed. Apply at Hershey's Shoes 29522 Ford Rd Garden City

512 Help Wanted-Sales

SHOE SALES PERSON

part time for women's specialty store. Only one evening on Sun days. Call Ellen 248 855 9855 Roz & Sherrin Maple & Telegraph

512 Help Wanted-Sales

TELEMARKETERS

Work from home. Great pay. Full or part time. Call Mon. Fri. 248 352 6333. Ask for Mike. Premium Protection ADT

512 Help Wanted-Sales

WIRELESS COMMUNICATION SALES REPRESENTATIVE

Candidates should be motivated self starters w/ at least one year of Verizon Wireless sales exp. Responsibilities include prospecting setting appts, making sales presentations & securing new accounts in the Greater Detroit market. Our company offers excellent benefits & the opportunity to earn above average wages (\$6K-\$10K). Please forward resume to Don at Veragent@amrnet.net or Fax resume to (810)227 0443

520 Help Wanted Part-Time

VAL PAK ADVERTISING

Sales Assistant Permanent Part-Time

Val Pak has an opening for a Sales Assistant based in Livonia 4 hours Mon thru Fri. Requirements include good communication and organizational skills, ability to handle multiple tasks and work for 4 individuals. Excellent working environment for the right candidate. Fax resume to 734 522-0246 or call Val Pak 28180 Schoolcraft Rd Livonia MI 48150 Attn: L Baker Email lbaker@valpakad.com

520 Help Wanted Part-Time

ALARM MONITOR

unique job for hrs 1-3 hrs/week. Night 2 afternoons 1-2 days. Computer customer service office plus pleasant Livonia office. low stress. 734 525 2767

520 Help Wanted Part-Time

CHILD CARE PROVIDER

needed for church nursery. Non smoker. CPR preferred. 8-16 hours per week, mostly nights. Send resume to First Baptist Church 44500 Cherry Hill Rd Canton MI 48187

520 Help Wanted Part-Time

CLEANING PERSONNEL

Part time. Northville. Livonia. Dearborn. Days, hallway & janitor. Call 248 536 9189

520 Help Wanted Part-Time

Delivery Specialist

We are looking for you! Part time delivery specialist. Approximately 16 hours per week. Tues and Thurs. Day time hours. Responsibilities include meeting our truck at Detroit area hospitals to distribute printed documents to various departments within Chicanos. Must be well groomed and have good communication skills. Work well with minimal supervision and be able to lift up to 50 lbs. Pay will start at \$9.00/hr. Candidates may fax resume to 517 321 2572 or send resume to Human Resource Distribution P.O. Box 18189 Lansing MI 48901 8189

520 Help Wanted Part-Time

DRIVER

Wixom. Our hours: weekends approx 20 hours/week. Retirees welcome. Call Monday, Friday 7am-4pm 248 689 6850

520 Help Wanted Part-Time

FUNERAL HOME GREETER

Part time. Some secretarial experience necessary. Call Giffin Funeral Home 734-522 9400

520 Help Wanted Part-Time

HOLIDAY DOLL

Store Help. Nov 1st - Jan 15th. Laurel Park Mall. Call Nancy Toll free 1-877-684 1782

520 Help Wanted Part-Time

IMMEDIATE OPENING FOR PART TIME SECRETARY!

Dependable and Friendly Person needed to work part time Mon & Wed 4:30-8:30 p.m. & alternating one weekend day at busy Real Estate Office. Duties include answering phones, typing & other clerical duties. Flexible to fill in occasionally other days/nights not required but a Plus! \$7.00/hr. Fax resume to 734-453 0704

520 Help Wanted Part-Time

JEWELRY SALES ASSOCIATE

Part time. Beautiful in downtown Plymouth (734)455-3030

520 Help Wanted Part-Time

LIFE GUARDS

eves & week ends. Must be certified in life saving first aid & CPR \$7.75/hr. Farmington Family YMCA Call Eric 248 553 1933

520 Help Wanted Part-Time

LOOKING FOR reliable part time people to install and maintain advertising in local grocery and mass merchandise stores in Southfield area. Steady flexible hours. No experience necessary will train. Own transportation required. Interested? Call N A M daily 9 5 to 1-800 866 3344

520 Help Wanted Part-Time

NEWS AMERICA MARKETING

seeking part time merchandiser to assist major tobacco company. Must be 21 yrs old. Valid drivers license required. Route to cover areas in the Metro Detroit Area. 20 hrs/week. Flexible scheduling. \$9/hr w/mileage paid. For more information call Penny at (734) 513-2603

25 Words + 13 Million Homes = Great Results

You can market your product to 13 million households throughout North America by placing your classified ad in more than 800 suburban newspapers like this one for only \$895

One phone call, one invoice one low pay ment is all it takes. Call the Suburban Classified Advertising Network fax on demand service at 800 356 2061 or 312 644 6610 x4731 to speak with a sales coordinator

524 Help Wanted Domestic

HOUSEKEEPER/COOK

5days/week. Some babysitting for my W. Bloomfield home. Refer to Jennifer 248 547 9900

524 Help Wanted Domestic

HOUSEKEEPER NEEDED

in Ann Arbor/Plymouth area. Full time position. Benefits available. Must have experience with time furnishings. References required. 734-623 8588

524 Help Wanted Domestic

HOUSE MANAGER

in Bloomfield hills to clean cook do laundry & run good salary w/ benefits. Experience and references required. Call Joanne (248)335 6387

524 Help Wanted Domestic

TWO ABLE bodied young men

to do yard work. Require some lifting & digging. \$10/hr. Call Patrick (734) 421 7323

HELP WANTED

Employment/ Instruction Services

#500-598

530 Entertainment

RAY'S PARTY TIME DJ

* Weddings graduations birth days & karaoke available! Ask for Ray (810)948-5058

600's Announcements

600	Personals	626	Political Notices
602	Happy Ads	628	Car Pools
604	Graduations	630	Cards Of Thanks
606	Mother's Day	632	In Memoriam
608	Father's Day	634	Death Notices
610	Holiday Potpourri	636	Lost & Found
612	Sweetest Day	638	Tickets
614	Valentine's Day	640	Transportation/Travel
620	Special Announcements	642	Health Nutrition
622	Meetings/Seminars	644	Weight Loss
624	Legal Notices	646	Insurance
628	Adoption	648	Bingo
634	Misc Notices		Wedding Chapel

700's Merchandise For Sale

700	Absolutely Free (1 day)	730	Commercial/Industrial
702	Antiques/Collectibles	732	Restaurant Equipment
704	Arts & Crafts	734	Computers
706	Auction Sales	736	Electronics/Audio/Video
708	Rummage Sale/Flea Market	738	Video Games Tapes Movies
710	Estate Sales	740	Farm Equipment
711	Garage Sales-Oakland	742	Farm Produce Flowers Plants
712	Garage Sales Wayne	744	U Pick
713	Moving Sales	746	Hobbies Coins Stamps
714	Clothing	748	Hospital Equipment
716	Household Goods	750	Jewelry
718	Appliances	752	Law Garden & Snow Equipment
719	Poo's Soas Hot Tubs	754	Miscellaneous For Sale
720	Bargain Buys	756	Musical Instruments
721	Bicycles	758	Sporting Goods
722	Buying Materials	760	Trade Or Sell
724	Business & Office Equipment	762	Wanted To Buy
726	Office Supplies		
728	Cameras & Supplies		

780-793 Animals/Pets

780	Animal Services/Supplies	787	Horse Boarding
781	Breeder Directory	788	Commercial
782	Birds	789	Household Pets
783	Cats	790	Pet Grooming/Boarding
784	Dogs	791	Pet Services
785	Farm Animals/Livestock	792	Pet Supplies
786	Horses & Equipment	793	Pet Wanted
		794	Lost & Found

536 Childcare Services-Licensed

CHILD CARE in my Canton home 12 yrs exp. All ages welcome. Meals provided. 734-495 9073

DAYCARE in North Redford area has openings for full and part time Monday-Friday 8am-5:30pm. Fun & loving environment with crafts and educational activities. Hot meals & snacks provided. Call Marcy at (313) 255 2887

LICENSED WESTLAND in home daycare. Meals provided. Openings for 19 month & older. Call Debbie (734) 326 8668

538 Childcare Needed

BABYSITTER in my Canton home for 2 boys 11 mos & 3 1/2 yrs 3 wks/wk. Exp. References. Non smoker. 734-981 5603

CHILD CARE 4 days/week. Bloomfield Hills address. Bright big sister age 20 and her cuddly little brother brand new. seek a nanny warm, creative, energetic & fun with clean and knowledge second to none. So if this sounds like you please don't delay we offer great salary, paid vacation & holidays! (412) 523 0327

FUN ACTIVE CAREGIVER wanted for our 18 month old daughter in our Farmington Hills home. Part time. Tues thru Fri. Call 248-427-9215

LIVONIA AREA Childcare seeking 2 persons for Sunday mornings. Competitive wage. Call for interview (734)425 7290

NANNY NEEDED Mon-Thur 8:30am-6pm to care for 3 month old in my Canton home. Light housekeeping. Must have own car. Non smoker. Experience and reference. 734-729 4160

SEEKING RESPONSIBLE person to care for 8mo old in my Plymouth home 4 days a week. Needs car. 734-455 7929

536 Childcare Services-Licensed

AFFORDABLE LOVING home daycare. Preschool activities. Warm meals. ECD & CPR certified. Tara (734) 326 8361

AFFORDABLE STATE LICENSED Preschool has openings for 2 1/2 to 5 yr olds. Hot meals, computer learning, age appropriate educational activities. 5th week free. Full time openings only. 734 425 3446

AMBITIOUS caregiver offers quality care & learning 1-4mo to 4yrs old. Livonia/96 area. 10 years exp. 734-522 8102

Michigan's Largest BURGER KING Franchise... Is Hiring for Hourly and Salaried MANAGEMENT POSITIONS!

MANAGEMENT CAREER OPEN HOUSE

for our Wayne and Oakland County locations

Wednesday, September 12th 10:00am - 6:00 pm

At our Livonia restaurant located at 29211 W. 7 Mile Road (E of Middlebelt)

If you cannot attend, please call our toll-free hire line 888-4BK-HIRE (888-425-4473)

ON-THE-SPOT INTERVIEWS!

We offer:

- Premium Wages
- Flexible Scheduling
- Complete Benefit Package
- Advancement Opportunities
- Free Meals
- Ongoing Paid Training
- 401 (k) Plan
- Paid Vacations

REAL ESTATE

70/30 Split. Great Training. New Office!

Call Mike Workman Sr @ 734 452 1180

Keller Williams Realty Livonia

SALES PERSON

Full or part time for lighting showroom. *Excellent Benefits & Pay*

Apply in person at BROSE ELECTRICAL 734-464 2211 & Newburgh Livonia

SALARIED!

REAL Estate Agents Starting Salary \$30,000 PLUS! Benefits (health 401K) Incentives

Experienced agents and new trainees welcome. No other program like it available.

Why look anywhere else? Work with the leader. GM REAL ESTATE ONE INC. For more information please contact Ashley Baker at 248-304-2299 Or simply fax a resume to 248-356-4110 careers@realestateone.com

Sales/Interior Design

A position in home furnishing available in Plymouth at Walker/Buzenberg Furniture 734 597 1524 Fax resume (734) 459 8826 Or phone (734) 459 1300

UNLIMITED OPPORTUNITY

LITTLE VALLEY HOMES with over 35 years in manufactured housing has a few openings NOW!

- Paid sales training
- Benefits
- Great earning potential

Candidates will be highly motivated. Sales background & good closing skills. Call now for confidential telephone interview 734 697 9558 Fax resume to 734 697 9558

534 Jobs Wanted-Female/Male

EXP HOUSEKEEPER

w/ references needs job 5 days/week exp in caring for elderly. Call (313) 872-9426

534 Jobs Wanted-Female/Male

QUALITY HOUSECLEANING

Livonia Area Weekly or Bi Weekly 734-306-3705

WOMAN 52 wants to come to your house to babysit full time days! Excellent references! Call Linda (734) 729 5800

534 Jobs Wanted-Female/Male

EXP HOUSEKEEPER

w/ references needs job 5 days/week exp in caring for elderly. Call (313) 872-9426

534 Jobs Wanted-Female/Male

QUALITY HOUSECLEANING

Livonia Area Weekly or Bi Weekly 734-306-3705

WOMAN 52 wants to come to your house to babysit full time days! Excellent references! Call Linda (734) 729 5800

538 Childcare Needed

AFTER SCHOOL CARE

Needed for 2 girls 11 & 8 Mon-Fri 2:30pm-6:30pm. Good pay. References required. W. Bloomfield. 248 737 0326

BABYSITTER wanted in my Farmington Hills home 8am-8:30am 248 474 6928

CERTIFIED HOME HEALTH CARE provider seeking work. Have car & exp reference. 25 Yrs exp. 248 569-7932

HAIRCUTS PERMS color for the homebound by salon owner \$5 off first visit. Hair Today Inc (810)823 7270

WILL CARE for your Elderly loved ones. plan meals. Doctor Appts etc. References available. Call Edith 734-397 4829

562 Business/Prof Services
ATTENTION DISORGANIZED PERSONS Files a mess? Piles of papers getting higher at home or at the office? The Top Organizer is for you! Call now before you can't find your phone! (734) 525 3190

564 Financial Service (See Class #082)
PARA PLANNER to assist financial adviser Must have series 7 & State of MI licenses 734 742 7567 9 5 30 Mon Fri

566 Secretarial Services
SECRETARIAL SUPPORT My home Redford Twp 30 years experience 313 534 0170

574 Business Oppt (See Class #90)
A HI PROFIT Vending Route! Earn Big \$\$ Must sell 1 888 571 0225 ext 2000

ARE YOU EARNING WHAT YOU ARE WORTH? Mail order business needs help immediately 522-a week part time \$1000-\$4000/wk full time Full training free booklet *thriveondreams.com 1 888 932 6679

ATTENTION WORK FROM HOME \$500-\$2500/mo part time \$3000-\$7000/mo full time Free booklet www.RichInHealthMoney.com 1 800 464-3689

ATTENTION Work from home! \$522/wk part time \$1000-\$4000/wk full time Free information 1 800 445 1829 www.HomeTreasury.com

574 Business Oppt (See Class #90)
ENJOY THE Freedom of working from home Control your hrs & income Full training & support 3 billion dollar industry leader Call for free booklet 1 800 335-8841 www.reachdreams.com

GROWING BUSINESS NEEDS HELPI Work from home Mail order/E Commerce \$522/wk part \$1000-\$4000/wk full time Free information (888) 717 8079 www.daydreamsincome.com

GROWING BUSINESS needs help Work from home Mail order/e-commerce \$522/wk part time \$1000-\$4000/wk full time Free information (610) 447 2255 www.ProsperousSystem.com

HALLMARK & Embassy Card Route No selling \$1000/wk pos. 10 Accounts w/cash \$8900 866 613 1408

NYSE CO looking for associates Earn from home No income cap Incentives car allowance 866-990 9534

REDUCE your company or residential phone bill by 70% 2.99 in state & 3.86 out of state 2 second billing No monthly fee For more info 866 980 9534

SEEKING BUSINESS partner http://www.usaapply.com 800 772 5326

WORK OUT OF YOUR HOME! Your space room could be your home office \$1 500 \$7 000/mo part/full time Free information (6 0 8) 9 8 5 4 0 0 0 www.creahomebiz.com

Announcements #600-698

600 Personals

ATTENTION CONSUMERS! Would you like to be paid for your opinion? Call 248 352 8997

636 Lost & Found

FOUND 2 dogs together black lab & husky shepherd mix Redford (313) 255 3390

FOUND Golden retriever/sheltie mix Found on Aug 30 near Lakeville (248)969 0429

LOST CAT Joy/Hix area in Westland male 4 yrs old beige tags Buckwheat 313-225 0788 / 734-453 9357

640 Transportation/Travel

ASK AN Accredited Cruise Counselor about your cruise vacation! 248 231 4225 travelbyeunice@aol.com

Merchandise #700-778

700 Absolutely Free

FREE FIREWOOD 31292 Mayville Livonia 734-421 1019

FREE GE gas range stove top & oven almost 5 years old works great 248 624 1823

FREE METAL desk Large 4x5 top with three drawers Gray in color (248) 797 1321

FREE PORTABLE Dishwasher you pick up Berkeley Ask for Debbie 248 546-1649

FREE Shed 6x12 Livonia 734 591 0799

FREEZER upright full size works good (needs seal) (248) 682 0634

OFFICE CUBICLE file desk w/hutch (248) 922 1702

702 Antiques/Collectibles

DEARBORN TOW SHOW Sat September 15th 9 2pm Admission \$4

HEYWOOD WAKEFIELD dining suite complete with original good condition \$1500 517 582 9212

MODERN TAPESTRY La Chasse w/custom top and decorative rosette cone \$500/ negotiable (248) 543 8404

SLOTS PINBALL VIDEO GAMES Buy Sell Trade Service (313) 770 1008

ATTENTION CRAFTERS! The Walnut Lake Central Craft show still has a few spaces available for its Nov 3 & 4 Craft show Please call Debbi Cooper (248) 363 0165 for more info

706 Auction Sales

NURSERY AUCTION As we are reducing our inventory we will be offering 300 400 SHADE TREES 2000 3000 EVERGREENS 1800 MISC SHRUBBERY Approx 3 000 plants Sat Sept 15 start at 10am 11 am resale 50750 Ford Rd Canton (734) 495 0900 5 miles W of I 75 No warranties offered or implied

706 Auction Sales

REAL ESTATE AUCTION 3 bedroom brick home w/2 car attached garage natural gas full basement across from golf course Farmington Hills schools 113 acres (138x360) We will have a Public Real Estate Auction at 36336 Eight Mile Rd Farmington Hills MI located W of Farmington Rd & E of Halstead THURS SEPT 13 AT 2 30pm OWNER Richard Halmekangas You can view and print our other auctions from our web site listed below Braun & Heimer Auction Service (734) 996 9135 (734) 994 6309 www.braunandheimer.com

NEED CASH? Sell it Classified CALL TODAY 734 591 0900 248 684 1701 248 652 3222

704 Arts & Crafts

PRECISION FABRICATING & CNC MACHINING FACILITY DIAMOND AUTOMATION 23400 Haggerty Rd Farmington Hills Michigan Tuesday, September 18th - 10:00 AM Inspection Dept. Monday September 17th - 9:00 AM to 5:00 PM Fabrication, (2) Spray Welding, (1) 2 Cnt. Shear Cnt & Pacific 200 Ton Press Brake, Saw, Welders, Flaming Equipment, Machinery, (3) Fadal CNC VMC's, 4 Surface VMC's, 1 VMC W&S ISC Turning Center, (2) Johansson Drills, (4) Bridgeport Surface Grinders, (10) Single & Multi Spindle Drills, Band Saws, Tooling & Accessories, Small Stock, Vitrolux Canteens Call For Brochure - 10% Buyers Premium CINCINNATI INDUSTRIAL AUCTIONEERS (513) 241 9701 or Fax (513) 241 6760 Website www.cia.auction.com Accepting Pre-Bids On Website

706 Auction Sales

WILES COUNTRY AUCTION Antiques • JD Riding Mower • Shop Tools • 3 Pickups • 1 Ton Dump • Amv • S of 8 Norda Accord We will have a public auction at 7075 CHAMBERLAIN DR DEXTER MI (Take N Terminal west from US 23 past Mast Rd.) SAT SEPT 15 2001 2PM OWNER Gloria Wiles You can view and print our other auctions from our web site listed below Braun & Heimer Auction Service (734) 996 9135 (734) 994 6309 www.braunandheimer.com

708 Rummage Sale/ Flea Markets

GREENMEAD BENEFIT New Dump • Amv • S of 8 Norda Accord Sept 9 10 4 Admission \$1

HUGE ESTATE SALE Sept 14-15-16 (Sat Sun Mon) 8511 Briarwood Plymouth (S of Ann Arbor Rd E of I 75) Antiques tools furniture crafts No Early Birds

TROY New queen pillow top w/ box spring furniture mens china glass ware pottery & Much More! 2632 Windsor S of Long Lake W of Dequindre Sep 13-15 9am 2pm

711 Garage Sales

AUBURN HILLS annual applance sale you dont want to miss Bosch dishwashers Viking & Wolf ranges & outdoor grills Gaggenau ovens Sub Zero refrigerators Whirlpool tubs & more Prior year models scratch & dents overstock in demo units at savings up to 50% of Wed thru Fri Sept 12 thru 14 9am 7pm Sat Sept 15 9 4 Treavor Inc 1295 Silverdale 248 377 3370

CANTON Huge 5 Family 1181 Brookline S of Ford E of Sheldon Wed Thur 9 5

708 Rummage Sale/ Flea Markets

CANTON ROTARY Club needs items for annual scholarship rummage sale For pickup call Bill Brown 734 420 2735 or 734-455 3344 The rummage sale is Sat Sun Sept 15 16 9 4pm Mettetal Air port on Lilley Rd in Canton

RUMMAGE SALE Thur Fri Sat Sept 13 15 11am 5pm 1700 Steiber Westland (Wayne & Merriman)

GARDEN CITY Antique furniture & Much more! Sep 12 14 9am 5pm 28906 Birchlawn Near Ford & Middlebelt

TRIO New queen pillow top w/ box spring furniture mens china glass ware pottery & Much More! 2632 Windsor S of Long Lake W of Dequindre Sep 13-15 9am 2pm

711 Garage Sales

FARMINGTON HILLS A Huge 5 family sale! Designer clothing, kid's clothes Little Tikes, antiques furniture & household items 8 6 Thurs Sun Sept 13 16 E of Halstead S of 9 Mile 21396 Parklane

FARMINGTON HILLS 3 family Thurs & Fri 8 4 Toys household kids clothes bunkbed crib furniture 31202 Westwood S of 14 Mile E of Drake

711 Garage Sales

BLOOMFIELD HILLS Sept 13 9 4 2360 Bloomfield Crossing bet Opdyke & Squirrel Rd off 17 Mile Household collectibles.

CANTON Giant multi family sale Baby toys furniture exercise household misc Sept 13 14-15 9am 4pm 51311 Hanford (Ford & Napier)

CANTON Huge multi family sale Baby items furniture appliances clothing & lots more! Sept 13 15 9 4 41396 Fernwood St E of Morton Taylor N of Hanford

CANTON Multi family 44947 Forest Trails off Sheldon bet Ford & Warren Thurs Sat 9 5

CANTON Sept 12 13 9 5 to 5 42865 Lombardy 4 houses E of Morton Taylor N of Warren Furniture & lots of misc

CONGRATULATIONS to C M of Livonia who won a \$50 gift card to Meijer Inc C M placed a garage sale ad in Sun Sept 2 and today's paper You too can be a winner To advertise your garage sale please call Wayne County (734) 591 0900 Oakland County (248) 644 1070

FARMINGTON HILLS A Huge 5 family sale! Designer clothing, kid's clothes Little Tikes, antiques furniture & household items 8 6 Thurs Sun Sept 13 16 E of Halstead S of 9 Mile 21396 Parklane

FARMINGTON HILLS 3 family Thurs & Fri 8 4 Toys household kids clothes bunkbed crib furniture 31202 Westwood S of 14 Mile E of Drake

SUMMER SALE Schedule a Home & Service Directory Ad for 4 times and we'll give you the ad for 6 times. That's 2 FREE ads! Call today! Oakland County.....248 644-1070 Wayne County.....734 591-0900

HOME & SERVICE GUIDE

011 Asphalt/Blacktopping
The Jeffery Co Commercial Blacktop Paving (313) 584 2430

022 Basement Waterproofing
EVERDRY BASEMENT WATERPROOFING Free inspections free estimates licensed bonded insured financing 70 000 satisfied customers Lifetime transferable warranty 800 878 9090

029 Brick, Block & Cement
AAA BRICK PAVING Pavers & All Masonry Work Repairs or New Lic & Ins Call Jeff (734) 432 7878

AAA CUSTOM BRICK WORK Additions Alterations Chimneys Porches STAIRWAYS & RAILINGS KITCHENS VANITIES-COUNTERS BASEMENTS DOORS WINDOWS STORE RENOVATION Lic & Ins 28 yrs experience 734-421-5526

A1 BRICK REPAIR Small jobs welcome Tuck Pointing Brick Repair Insured 248 478 7949

Advanced Porch & Concrete Porches Patios Drives Sidewalks Lic & Ins 734-281-2655 248-909-4481

ALL BRICK WORK 10% off (with this coupon) Brick Repair Specialist Chimney • Porch etc 248-706-9224 734 416 0800

ALL CONCRETE Drives porches patios & walks Also brick block & foundation work Lic & Insured Free Est Call anytime TODD HUMECKY 248-478-2602

ALL TYPE MASONRY REPAIR WORK Chimney porches tuck pointing Free Est Cornerstone Masonry (734) 729 7785

ATINA CEMENT CONTRACTORS All types of cement work driveways garages/patios Free Est Lic/Ins (734) 513-2455

BRICK PAVERS CONCRETE Driveways Brick Block Patios SUNSET CONSTRUCTION 313-541 9936

CANTON CEMENT COMPANY Drives garage floors etc Free removal on replacements Lic/Ins Free est 734-261 2818

D & A CEMENT CO Small jobs accepted Free estimate Lic & Insured 313 271 7371 734 458-4587

031 Building/Remodeling
ADDITIONS PLUS INC • Beautiful Additions • Kitchens • Baths • Custom Cabinetry • Custom Home Renovations including Lower Levels Guaranteed quality workmanship Complete plan & design service available Lic & Ins 734 414 0448

BATHTUB • CERAMIC TILE Repair • Remodel Replaze Call For Free Brochure Unique Refinishers Inc 1 800 235 6557

GRANTS CABINETS INC Specializing in all areas of kitchen & bath remodeling & counter tops 313 531 8491

Rec Room Kitchen Bath Specialties All Remodeling Formica & Laminate VISA & IC AMEX 248-476-0011 313-635 8610

A FAMILY BUSINESS RON DUGAS BLDG 8846 CROWN LIVONIA • A PERSONAL TOUCH • STAIRWAYS & RAILINGS KITCHENS VANITIES-COUNTERS BASEMENTS DOORS WINDOWS STORE RENOVATION Lic & Ins 28 yrs experience 734-421-5526

AFFORDABLE CARPENTRY Trim • Doors • Cabinets • Base ment Framing & more Lic/Ins Fred 248 380 3815

CARPENTRY BY JOHN Specializing in libraries mantels kitchens & all types of trim work Free estimate 313 534 8452

CARPENTRY TRIM Crown moldings mantels kitchens & basements We trim complete homes Builders welcome Lic Ins since 1983 (734) 595 1871

CLASSIC CARPENTRY Kitchens Libraries crown & wall moldings panel door units trim hardwood floor repair & install All work by expert Carpenters 313 541 9289 248 894 3094

FINISHED CARPENTRY • Crowns • Doors • Railings • All Phases Lic 734 455 3970 http://resplenzawebprovider.com/qualitycarpentry/

HIGH QUALITY CUSTOMIZED WOODWORKING Kitchens • Floors • Furniture Masterworks 248 763 7210

WE DO GARAGES Modernize your old garage Tear down build new Repair old to new condition New garages Lic Ins (734) 595 1871

248 471 2600 313 835 8610 Rec rooms Basements Kitchens Bathrooms New & Repairs

048 Chimney Building/Clean/Repair
AAA BRICK Chimneys And all masonry work New or repairs Lic / Ins 27 yrs exp Call Jeff (734) 432 7878 Toll free 1 888 MR BRICK

AAA CUSTOM BRICK WORK CHIMNEY SPECIALISTS Very clean quality work 25 Yrs Exp New & Reps s (248) 477 9673

ALL TYPES of masonry work New and repairs Roof leaks and chimneys (810) 229 8567

Chimneys Will beat any price! Senior citizen discount BEST CHIMNEY INC 248-557-5595 313-292-7722 4214 Woodward Ave Oak Park MI

JRA CONSTRUCTION CO Chimney and porch repairs brick work roofs seamless gutters steps and tuckpointing Lic and insured call for free estimate 1 888-440 6047

CHEYL'S TOTAL CLEANING Let Me do the DIRTY work Res & Com! Most supplies provided Cheryl (248) 615 3708 www.cheylstotalcleaning.com

YOU'VE GOT IT MAID! Residential & Commercial cleaning Free Estimates Contact Susan 313-510 1163

055 Concrete
COMMERCIAL/ RESIDENTIAL driveways porches Patios Specializing in brick pavers 248 613 8092 248 736 8000

Excavating Trenching Footings Sewer Water Lines Parking Lots Septic Tanks Drains Bulldozing Lic & Ins 313-838-6731

084 Firewood
ADMIRE YOUR FIRE WELL SEASONED HARD & BIRCH PICKUP & DELIVERY HACKER SERVICES QUALITY SINCE 1946 (248) 474 6914

AMERICAN HARDWOOD Hardwood Floor Specialist Member of Better Bus Bureau 20 years exp 313-646-0942

BEAUTIFUL HARDWOOD FLOORS Install Sand & Finish Lic & Ins (734) 595 1871

730R MASTER 98% dustless refinishing Specializing in installations refinishing repairing Lic/Ins Brian 248 942 0323

069 Drywall
A1 PLASTER & DRYWALL • New & repair work • Texture • Cores • Dust free repairs • All work guaranteed 32 yrs exp Insured 248-478-7949

★ DRYWALL FINISHING & PATCHWORK ★ Free Est Reasonable Prices John • 734-427 6289 ★

ABSOLUTE QUALITY ELECT Free Est Lic/Ins Call Livonia Electric Co 313 706 6185

ALL RESIDENTIAL EXPERT Free estimates Senior discount Low prices 7 days 24 hrs Lic & Ins Call 1 800 253 1632

ARNOLD ELECTRICAL CONTRACTOR City & FHA violations corrected Comm/Res 734-462 1877

BIDWELL ELECTRIC • Res & Comm Work Service Changes Circuits added etc Lic & Ins 734 451 7449

ELECTRICAL CONTRACTOR No charge for estimate Call Jack or Carl 734 484 5813

FAMILY ELECTRICAL City car tification • Violations corrected Service changes or any small job Free estimates 734-422 8080

FREE ESTIMATES Installations & repairs Small or Large Lic/Ins 248-872 8060

Hot Tubs! Ceiling Fans! New Construction all your electrical needs Lic & Ins Builders Welcome! (248) 471 1085

RES COMM WIRING/REPAIRS Low Rates Free Est Licensed 313-833-3800 or 248-521 2550

073 Excavating/Backhoe
Building Excavating Finish Grading Parking Lot Sewer & Water Repair Ponds Trenching Pool Removal Demolition Lic & Ins d 734-459-8268

Excavating Trenching Footings Sewer Water Lines Parking Lots Septic Tanks Drains Bulldozing Lic & Ins 313-838-6731

086 Floor Service
OAK FLOORS Expert Floor Sanding • Staining Repairs • Moldings Your complete wood floor service 734 692 0040

A FLOW RITE Seamless Gutters Installed & Repaired Cleaned & screened Est. 1978 Lic/Ins 734 459 6280

CLEANING SCREENING REPAIRS Joe 313 601 7173 or 313 204 2655

Farmington Maintenance Gutters cleaned Expert Repairs (248) 473 3931

GUTTER SHOP Seamless aluminum gutters Fast on time Service Insured (734)341 3186

LIVONIA GUTTER ★★ cleaning • retooling of loose gutters • screening • ic repairs new gutters • 248 568 1948

0102 Handyman M/F
KRAMER TRIAD HOME SERVICES 248/836-4774

AAA WEE PROJECTS • Misc Plumbing Electrical Car pentry Furniture assembly & All small jobs! 248 777-0082

ABLE BUILDER LIC & INS All Repair & Remodeling ANY Size Job AAA Quality Always Call 734-728 3418

ALL AROUND HOME REPAIRS & Installation Plumbing electrical carpentry Painting etc Joe Licensed 313 537 6945

AL'S DO IT ALL Carpentry/Elect/Plumbing/Paint (248) 477-4742

WE DO AMERICA'S HOMEWORK • Drywall Repair • Lighting Fixtures • Weatherproofing/ Caulking • Leaking Faucets • Tile Repair & much more Our experienced Technicians are properly bonded & insured Prompt Safe Reliable in the Plymouth-Canton area call (734) 981 0573

HANDYMAN SERVICE Kitchen Bath Basement remodel Cement Work Painting Drywall (313) 929 0057

103 Hauling/Clean Up
BAYSIDE GARAGE REMOVAL Moving Hauling Clean up also provided (734) 504 3343

BRAD'S CLEAN UP & HEAVY CONSTRUCTION SITE MAINTENANCE Call (734) 604 3343

D & J MOVING & HAULING Clean up hauling & disposal of misc items We haul anything 10 15 yd dumpster trailers You load we load Westland/Ann Arbor VISA/MC accepted 734-421 0111

JDC HAULING Co Res Comm Debr s Rubbish Concrete etc 7 days Joe 313 601 7173 or 313 204 2655

AFFORDABLE PERSONAL HAULING SERVICE We clean out homes attics basements garages offices warehouses & anything else Complete demolition from start to finish Free est 248 354-3213

Furnace Installation from \$1195 w/ \$250 Duct cleaning from \$199 Free Est Lic/Ins 35 yrs exp 24 hrs svc All makes/models 734-266-0547 313-477-4210

AAA WEE PROJECTS • Misc Plumbing Electrical Car pentry Furniture assembly & All small jobs! 248 777-0082

ABLE BUILDER LIC & INS All Repair & Remodeling ANY Size Job AAA Quality Always Call 734-728 3418

ALL AROUND HOME REPAIRS & Installation Plumbing electrical carpentry Painting etc Joe Licensed 313 537 6945

AL'S DO IT ALL Carpentry/Elect/Plumbing/Paint (248) 477-4742

WE DO AMERICA'S HOMEWORK • Drywall Repair • Lighting Fixtures • Weatherproofing/ Caulking • Leaking Faucets • Tile Repair & much more Our experienced Technicians are properly bonded & insured Prompt Safe Reliable in the Plymouth-Canton area call (734) 981 0573

HANDYMAN SERVICE Kitchen Bath Basement remodel Cement Work Painting Drywall (313) 929 0057

AFFORDABLE Personalized Housecleaning Professional Dependable Call Lynn 734-377 4196

121 Landscaping
AAAA Beautiful Yard LOW COST!!! MASTER GARDENER Design • Installation Trees Stumps Odd Jobs WE DO IT ALL Ins/Ref • 20 yrs exp Wayne 734-525-3600 Oakland 248-855 5252

ACE LANDSCAPING • Cleanup shrub removal weed n/trim n/sg/soil/plants Complete landscaping VISA/MC accepted 734-421 0111

JDC HAULING Co Res Comm Debr s Rubbish Concrete etc 7 days Joe 313 601 7173 or 313 204 2655

AFFORDABLE PERSONAL HAULING SERVICE We clean out homes attics basements garages offices warehouses & anything else Complete demolition from start to finish Free est 248 354-3213

Furnace Installation from \$1195 w/ \$250 Duct cleaning from \$199 Free Est Lic/Ins 35 yrs exp 24 hrs svc All makes/models 734-266-0547 313-477-4210

AAA WEE PROJECTS • Misc Plumbing Electrical Car pentry Furniture assembly & All small jobs! 248 777-0082

ABLE BUILDER LIC & INS All Repair & Remodeling ANY Size Job AAA Quality Always Call 734-728 3418

ALL AROUND HOME REPAIRS & Installation Plumbing electrical carpentry Painting etc Joe Licensed 313 537 6945

AL'S DO IT ALL Carpentry/Elect/Plumbing/Paint (248) 477-4742

WE DO AMERICA'S HOMEWORK • Drywall Repair • Lighting Fixtures • Weatherproofing/ Caulking • Leaking Faucets • Tile Repair & much more Our experienced Technicians are properly bonded & insured Prompt Safe Reliable in the Plymouth-Canton area call (734) 981

AUTOMOTIVE

observer-eccentric.com

711 Garage Sales

HIGHLAND TWP 4 families 2176 Jackson Blvd Duck Lake Rd N of M 59 2 wks Thurs Sun 10 to 6 3 piece reclining couch set desk table vacuum hamster cages doorwall computer equip lawnmowers exercise equip lawn mower drop ceiling panels

LIVONIA Antiques wicker quality clothing & more 9 5pm Sept 11 14 15524 Ingram

LIVONIA huge moving sale all must go Sept 13 thru 18 Hrs 8-12 S of E of Farmington Rd Furniture misc items

LIVONIA MULTI FAMILY Sept 13 & 14 from 9-4 & Sept 15 8-12 S of E of Farmington Rd 36449 Oakdale

LIVONIA Sept 13 14 15 3pm 16220 Quakerstown S of 8 Mile E of Haggerty Couch loveseat tables futon fridge toys clothes and stereo speakers

PLYMOUTH MOVING/GARAGE sale after 30 years antique baking equipment & cash register 1st tools books crystal and holiday decorations don't miss it! 14266 Shadywood Dr between Hines J & Schaeffer off of Wilcox Sept 13th 14th & 15th 7am 2pm

PLYMOUTH Sept 13 14 Baby girl clothes to 3T & other house hold items Partridge Dr

PLYMOUTH 9031 Brookline Joy Rd & Sheldon Rd Sept 13 14 9am 4pm Misc items

TROY Annual Westford Condo-verse Garage Sale Sept 15 9am 5pm 1 blk E of John R S of Rin Bear

WESTLAND 2 family sale Sept 12 13 14 9-4 1272 Michael (take Fairchild off Wild Wood S of Cherry Hill)

WIXOM SUB WIDE sale Loon Lake Woods off of Wilcox Dr thru Bensten & Wixom Rds Thurs Sat

712 Garage Sales Wayne

CANTON Brookside Fall Sub Sale Cherry Hill & Lotz Thurs Sun Sept 13 16 Many house hold kid & yard items clothes all sizes & more

CANTON Sunflower Sub Thurs Sept 13 thru Sat Sept 15 9am 7 W of Canton Center Rd N & S of Warren Rd Look for signs & yellow balloons

713 Moving Sales

BED SET Ethan Allen maple 6 piece Dining table w/ 6 chairs 4 end tables 3 Lamps Chairs misc & more! 248 360-2679

DEARBORN HGTS garage & moving sale 7002 Fenton (1st traffic light on Warren Ave W of Telegraph) Clothes furniture glassware collectibles & more Sept 13 16 8am 5pm

FARMINGTON HILLS 2 sofas twin green 2 sofas plaid green 1 rse coffee tables lamps end tablement center Antique pump organ & Boos chopping block nice metal office desk credenza file cabinet and chair boys dark pine bedroom set small freezer and more! Best offers must sell Call 248 788 8456 or Email sus099@aol.com

SECTIONAL SOFA with end tables lamps breakfast set 4 set on utility (734) 397 7169

714 Clothing

BLUE FOX Jacket Hip length Size small \$50/best (248) 888-9527

716 Household Goods

ALL LEATHER 100% Italian full grain premium select grade A leather couch love seat chair ottoman Buy Mantelali leather in Italy with warranty unused in wrapper Cost \$5K sacrifice \$1950 cell phone 313 477 0979

AREA RUGS dining table/chairs humidor 14 gal 24 hr capacity \$100 (248) 355 9854

ART DECO dresser & chest \$485 Sofa with cast wood \$700 Oak dining set \$500 Traditional chair new fabric \$200 Misc coffee tables New Cherry wood entertainment center \$675/Exc Cond 248 356 5195

BEAUTIFUL WHITE IRON DAYBED Excellent cond \$200 Call (248) 477 6333 eves

BEDROOM 6 piece traditional Henredon Set w/chair \$1200 248 210 6212 248 641 8369

BEDROOM SET girls 3 pieces also bedding & headboard \$175 best offer 248 344-4806

BEDROOM Set Gorman's beautiful spiral 4 pc iron Country ivory crackle finish \$3000 new sell \$450 African leopard bedding ensemble other furniture 248 693 3315

BEDROOM Set 4 pc Stanley 8 pc \$450/best (734) 462 6347

BEDROOM Set king sized \$350 (248) 649 6386

BEDROOM Set Solid oak oak queen bed dresser 2 nightstands King headboard \$800 (734) 522 1627

BEDROOM Set Thomasville oak queen bed dresser mirror armoire 2 nite stands \$500 Good condition 734 397 5659

BLACK LEATHER couch loveseat animal area rugs maple tables 60 inch big screen tv originally over \$13000 Over 75% off (248) 249 4411

BRAND new solid birchwood kitchen w/ leaf & 4 chairs \$1100/best 248-414 6804 (734)421 2050

CLARKSTON OAK bedroom set full/queen size headboard night stand triple dresser w/ mirror armoire all for \$600 Particle board entertainment center for \$45 (248) 625 6759

COUCHES (2) light burgundy w/taupé grapevine pattern Exc cond \$1199 (248) 593-9346

COUCH LA Z BOY RECLINER mauve \$400 love seat multi color mauve tail & gray \$300 All exc (734) 513 0153

COUCH LIKE new \$500 large computer desk cherry dining set \$300 Hammond organ \$3000 (248) 624 7256

COUCH & loveseat beautiful black leather 1 yr old Coffee table \$2500 248 477 6429

CRIB AND CHEST child craft white w/ oak t m \$350 Pigeon stool \$100 Little Tykes cottage \$60 Antique infant bedroom set \$500 (248) 442 1225

716 Household Goods

DECK FURNITURE 7 pieces white great cond \$500 (248) 553 4757 after 6pm

716 Household Goods

DINETTE SET Gorman's glass top exc cond 6 beautiful chairs (313) 665 1062

DINING ROOM beautiful Duncan Phyfe mahogany china cabinet buffet & table w/2 leaves & 6 chairs \$2100 Thomasville solid maple queen bed double dresser w/mirror chest of drawers 2 nightstands exc cond \$1900 2 circa 1940 leather top tables step table \$225 Coffee table \$200 (248) 349 6924

DINING room chairs 6 Henredon Traditional Sage leaf print \$900 248-647 1120 or 248-641-8677

DINING ROOM set w/3 drawer china cabinet \$1800 Glass table w/4 captain swivel chairs \$300 White kitchen table w/6 chairs \$300 Misc yard & kitchen items (734) 414 9951

DINING set Nelson Simon dark oak w/6 ladder back chairs 2 leaves \$900 248 641 8677

DISHES Mikasa Firesong almost complete set of 8 many extras \$150 248-813-8592

DUNCAN Phyfe Dining set \$1000 Desk \$250 2 Queen Anne chairs \$350 248 666-4815

ENTERTAINMENT Center 18ft 5 pieces w/ matching cocktail table Custom taupe formal built in bar bookshelf storage Exc Con Will sell together or separate 248 855 4686

ESTATE SALE moving out of state Everything for sale Fur mite lamps etc 248-334-2300

FURNACE, marble bathroom sink & cabinet porcelain bath room sink & cabinet Window A/C 248 668-0316

GIRLS TWIN bed White washed 3 yrs old Mattress not included \$300 248 594 9573

HOUSE OF Denmark bedroom set teak \$5000 value \$2500 firm Exc cond 313-633 1166

LEATHER Couch loveseat chair ottoman & grandfather clock Exc snape \$3300/best 734-261 5745

Loveseat Lounger beige pastel upholstery oak trim good cond \$75 (248) 673 6208

MOVING MUST sell Love seat 2 end tables 2 lamps coffee table all for \$85 (734) 844 2238

ONEIDA SILVERPLATE service for 12 + serving pieces & silver chest \$400 Mink Suite \$76 (734)421 2050

PICNIC SET Wood Gray stained 5 pcs w/pads exc cond \$220/best (248) 723 0848

1 9 PIECE mahogany solid wood set w/gigantic 4 poster/sleigh bed chest dresser mirror 2 night stands (Burnham Embassy Row look!) unused still boxed Cost \$9000 Must sell \$2750 Armoire available \$850 248 788-5815

RATTAN FURNITURE 4 pcs \$200 (734) 522 1341

REFRIGERATOR & stove aluminum Oak entertainment center 734-394 1409

SECTIONAL blue/gray/tan good cond contemporary \$489/best After 6pm 248-348-3518

SOFA beautiful rose & cream silk plaid mint condition 734 354-6378

SOFA Gorman's rose & cream either new never used A great deal! 313 565 6908

716 Household Goods

SOFA CUSTOM Henredon blue velvet \$125 Porcelain lamp \$50 313 278-0445

716 Household Goods

SOFA & matching loveseat 2 yrs old blue/cream exc cond \$600 (734) 937 0377

SOFA Sherill 78 green/rose/blue floral tapestry spring down cushions \$800 248-626-2185

TWIN BED w/mattress dark walnut w/bookcase headboard \$75 Pool table \$750 Trampo line \$50 Lazy Boy multi color blue couch love seat & 2 chairs also 5 tables \$500 2000 Cava tier black 20 000 miles take over lease for next 2yrs/plus \$2000 down call between 9 5pm 478-4617

TWIN X L 39 x80 Craftmatic II adjustable bed w/massage & heated mattress pad brand new (1799) best offer 734-462 2646

VINTAGE original cherry ladder back dining chairs & table \$1000 Tufted black sofa \$200 High quality 248 593 3292

WASHER & Dryer Whirlpool \$250/best (248) 258-5891

YEAR OLD full size King Koil mattress exc cond \$50 (313) 532 2870

718 Appliances

BRAND NEW GE White Elec Tric Range Never used \$325 248 486 1546

Dishwasher (black) Whirlpool Quist 4 settings w/6 options \$95/best (734) 451 8956

GE RANGE electric self cleaning oven excellent cond \$145 (734) 422 5262

HOT POINT heavy duty large capacity washer hot point heavy duty dryer both almond & both very good cond \$100 each & \$175 for pair (734) 542 7907

SIDE BY SIDE GE freezer refrigerator w/crocker recent model 30 inch electric range exc cond both almond & \$489 (734) 495 0957

719 Pool/Spas/Hot Tubs

SPAS SPAS SPAS over 30 new spas reprocessed from local dealer All 2001 models never used still in wrapper All must sell at cost or below 248 789 5815

2001 FLOOR MODEL SPA BLOWOUT!!! Example 4 person spa Regular \$2999 Now \$1999 Super II 6 person, Niagara Regular \$5999 Now \$3450 Call George (734) 261 5811 I can finance & deliver

722 Building Materials

STEEL BUILDINGS New must sell 40x60x12 w/ \$17 500 now \$10 971 50x100x16 was \$27 850 now \$19 990 80x135x16 was \$79 850 now \$44 990 100x175x20 was \$129 600 now \$84 990 1 800-406-5126

CLARINET WOODEN w/stand \$460 Beginners Clarinet \$75 (734)981 4373

GRAND PIANO Steinway player beautifully restored built 1928 many duo act roles \$22 000 (248) 681 7133

GRINNELL PIANO baby grand mahogany 1950's good cond \$2 500 (248) 684 7654

15 INCH viola Excellent condition with carrying case \$300/best (248) 626 7623

OBOE Yamaha student model \$500 (248) 348 2754 eves

YOUNG CHANG piano upgr hd mahogany 4 6 long \$3000 best Yvette 248 569 7392

PIANO excellent cond ton 248 474 0539

GRAND PIANO Yamaha G3 6ft 11n Gloss black Tuned reg ultry Mint \$15 000 (248) 478 6361 (313)937 0759

PIANO Grinnell Spirit good cond \$800 (248)644 7395

PIANO Steinway vertical mahogany finish hepplewhite style \$6500 734-671 8034

PIANO Yamaha console w/bench exc cond \$2800 (248) 644 5485

SAXOPHONE Alto Conn new pads & case Upgraded mouth piece \$735 734 459 3147

SAXOPHONE Selmer Bundy II Alto w/ case Good for student \$395 (248)623-4673

THIRTEEN PEDAL Lowrey organ \$75 Call (248) 476 2834

747 Jewelry

RADO DIASTAR Watch with cal endar 2 tone bracelet \$1000 (248) 851 0385

748 Lawn Garden & Snow Equipment

Craftsman tractor 19 5 hp 46 cut used 1 season exc cond w/agon \$950 SOLD

DIXIE CHOPPER riding mower 0 turn 42 cut 18 hp Exc cond \$1400/best (248) 478-8274

GARDEN TRACTOR John Deere LT155 38hp mower #10 trailer snow plow w/ chains & trunk \$1 600 John Deere snow thrower w/ electric start \$150 All new! Moving Must sell 248 788 8456 sus099@aol.com

750 Miscellaneous For Sale

FRONT DOOR unit 2 bathroom sinks bed & dresser with mirror \$1400 (734) 738 0085

HOW TO LIVE WELL FOR UNDER \$1000 a Month Free Information Second Chance P O Box 6327 Monona WI 53716 www.wywindsecondchance.com

INVENTORS FREE INFOR MATION PACKAGE Have Your New Product Idea Developed & Professionally Presented to Manufacturers Call Davison An Award Winning Firm Patent Assistance Available 1 800 677 6382

LITTLE TYKES misc \$5 to \$20 each Westland (734) 729 1234

boxes dist barrels bubble & wrap \$275 (248) 656 3589

POOL Kayak 16x32 2 ft decks w/2 ft walk around 20x40 As is you take down \$1200 (734) 397 0877 aft 11

SEARS Car top carmer 18 ft ct \$25 4 draver steel gray fire cab inet \$40 (734) 453 0785

TRAILER HITCH fits 1999 2000 Ford F 150 \$150 Sears 10 table saw \$150 734 425 8944

WALDEN Woods Full camping membership 6x4 yrs full \$3700/best (810) 997 3781 eves

WINE & BEER making equip ment Grape press grape crusher Wine & Grolschus bottles (248) 437 0118

WOOD COMPONENTS for a dormitory loft \$50 car/van top carrier \$50 (248) 353 6325

751 Musical Instruments

ARMSTRONG ALTO saxo phone whard case \$750 (248) 634 5924

CLARINET WOODEN w/stand \$460 Beginners Clarinet \$75 (734)981 4373

GRAND PIANO Steinway player beautifully restored built 1928 many duo act roles \$22 000 (248) 681 7133

GRINNELL PIANO baby grand mahogany 1950's good cond \$2 500 (248) 684 7654

15 INCH viola Excellent condition with carrying case \$300/best (248) 626 7623

OBOE Yamaha student model \$500 (248) 348 2754 eves

YOUNG CHANG piano upgr hd mahogany 4 6 long \$3000 best Yvette 248 569 7392

PIANO excellent cond ton 248 474 0539

GRAND PIANO Yamaha G3 6ft 11n Gloss black Tuned reg ultry Mint \$15 000 (248) 478 6361 (313)937 0759

PIANO Grinnell Spirit good cond \$800 (248)644 7395

PIANO Steinway vertical mahogany finish hepplewhite style \$6500 734-671 8034

PIANO Yamaha console w/bench exc cond \$2800 (248) 644 5485

SAXOPHONE Alto Conn new pads & case Upgraded mouth piece \$735 734 459 3147

SAXOPHONE Selmer Bundy II Alto w/ case Good for student \$395 (248)623-4673

THIRTEEN PEDAL Lowrey organ \$75 Call (248) 476 2834

TROMBONE \$250/best (734) 981 2624

783 Cats

RESCUED CATS & kittens tested shots vet checked Call Barb (248) 363 2676

784 Dogs

AUSTRALIAN SHEPHERD pups AKC/ASCA registered \$450+ (248) 231 0705

Chocolate miniature pinchers AKC \$700 Also stud service available 734 498 3735

GERMAN SHORTH Hair Pointer Pups AKC registered champion field & show blood lines Ready 9 18 Males \$375 Females \$450 734 782 2658

CHOCOLATE LAB PUPPIES AKC Health & hip guaranteed Big blocky and beautiful not a mill Ready 9 27 810-735-9494 (1799)

MASTIFF PUPS AKC females \$1000 (810) 688 3275

SHELTY PUPPIES AKC vet checked ready to go Leave message (248) 478 3169

2 SIBERIAN HUSKIES 1 red male 1 black female less than 1 year old purebreds w/papers \$700/best (734) 422 1209

780 Horses & Equipment

HORSE Registered thorough bred/quarterhorse male 5 yrs black \$2000 313 683 0363

788 Household Pets

FERRETS 2 very sweet new caged males 1 Yr old w/papers & ferret \$200 248 624 0509

802 Boats/Motors

ALUMACRAFT 1991 18 ft 115 hp motor/6 hp trolling motor trailer \$7200 313 561 9304

ALUMACRAFT 1991 18 ft 110 Johnson roller trailer good cond more \$5500 248-426-9821

BASS BOAT 1982 Thompson 40hp Mercury 1991 trolling motor live well needs upholstery work includes new trailer \$2000 Call (248) 643 4965 ask for Greg

BAYLINER TROPHY 1980 20 ft center console 125 horsepower outboard bimini top player boards \$7200 (734) 453 6661

BLUE FIN 14 trailer w/new tires 15hp Evnrude newly tuned \$1 400 313 274 2066

BOAT fiberglass trailer 70 hp Johnson trim & tilt power w/nch extras \$2700 (313) 537 2327

BOWRIDER FIBERGLASS 18 ft 6 inches 85 horsepower out board 313 563 4320

CAD LAC 12FT fishing boat & tra e completely up bashed like ne Coor buy at \$900 Refold d 3 3 83 110

CANOE 18FT Only used once Holds 800 lbs \$450 313 926 6534

CAPRI 1997 16.5 sailboat furling jib hiking straps options w/trailer FAST & FUN exc cond \$4 200 734 453 8294

CELEBRITY 1994 27 immaculate rack stored since new 350 Mercury full galley aftcabin microwave shower hot water 250 hrs \$29 000 313 383 6388

CHAPARRAL 1985 190CXL 170hp I/O w/trailer \$4600/best 248-661 7895

CHAPARRAL 1998 1630 SS Bowrider 4 3 Mercury 70 hrs mint cond stored indoors yr round includes trailer \$17 000/best (248) 360-6552

CHAPARRAL 216SS1 2000 bow rider 5 0 trailer all covers stored inside sharp 30 hrs \$27 800 (734)525 5159

CHAPARRAL 216SS1 2000 bow rider 5 0 trailer all covers stored inside sharp 30 hrs \$27 800 (734)525 5159

CHRIS CRAFT CORINTHIAN 1979 33 New twin 350's sleeps 6 well maintained \$34 500/best 734 721 8084

CHRIS CRAFT 1956 17ft sportsman w/trailer Kl engine \$6 500/best (248)471 9140

CLASSIC AMF Fiberglass 18 ft sailboat with trailer 1977 great shape barely used \$1350/best 313 533 0211

CRESTLINER KODIAK 1998 18ft w/ trailer 50hp Yamaha 4 stroke Avery duct built Attention duck hunters \$11 000/best 734 0425 6995 or 313 958 8148

CREST 2000 Pontoon 22 ft like new best offer Con tact Henry 248 390 1340

CREST PONTON 25 ft 35 hp Evnrude ladder & chairs \$2700 248 682 6866

807 Motorcycles/Minibikes/Go-Karts

HARLEY DAVIDSON 2000 FXR4 limited edition 1 of 750 built new only 9 miles \$19,500 (248) 760-6411

HARLEY DAVIDSON Fatboy 1997 Custom paint exc cond \$16,000/best 313-277-4922

HARLEY DAVIDSON 1999 Heritage Softail 2300 miles \$17,000 (248) 476-7649

HARLEY DAVIDSON 2000 Heritage Soft Tail Custom Classic Black lots of extras! 7k miles Exc cond Extended warranty \$18,500 Nights 734-513-8459

HARLEY DAVIDSON 2002 Heritage Classic No miles real red/ice \$21,500 (248) 448-8292

HARLEY DAVIDSON 1998 Low Rider 7000 mi showroom cond \$2000 worth of accessories \$14,800/best 313-277-2920

Harley Davidson 2000 Road King Classic 5000 miles lots of extras \$18,500 248-921-8888

HARLEY DAVIDSON 1998 soft tail custom 9k miles \$3400 and accessories \$17,000 (734)955-5481 (517)546-3400

HARLEY DAVIDSON Super glide 1999 extra clean original owner \$17,000 Harley Davidson Sportster 883 1990 \$5500 (734) 522-9366

HARLEY DAVIDSON 2000 Sportster 1200 custom \$8000 (248) 960-1095

HARLEY DAVIDSON 1997 Soft tail Classic 2 tone stage one package beautiful cond extras \$17K \$14,700 248-486-4590

HARLEY DAVIDSON 2001 Sportster 883 only 650 miles like new \$7,500 (248) 650-9327

HARLEY DAVIDSON 1986 Tourglide 21k miles burgundy chrome kit \$9500/best (248) 693-2315

HARLEY davidson 1997 Road King Low miles many extras, immaculate \$13,500 (734) 944-9999

HARLEY Dyna glide 1998 FXDS Exec Cond Extras included \$13,500 (248)568-6186

HARLEY 1994 Dyna Low Rider 3114 miles \$2,600 in accessories Adult owned \$11,995/best (517) 688-9157

HARLEY 2000 Electra Glide Classic 7.3k Miles black stage one screaming eagle performance kit lowered 1.0 in windshield \$20,000 (810)836-7817

HARLEY 1999 Electra Glide 3k 90% HD extras Mint Lazer Red \$10,000 313-342-2852

HARLEY 1992 Electra Glide Classic to tone blue low miles exc cond \$13,000/best Eves 734-591-9431

HARLEY 2000 Fat Boy thud derheaders all touring accessories black/red 5500 miles \$18,950 (248) 932-3480

HARLEY 1989 FLHS performancer enhanced new paint many extras Sweet ride \$10,500 (248) 693-7361

HARLEY 1994 FXRP nice bike Many extras \$11,500 248-681-2653

HARLEY 1989 Heritage soft tail black/cream Exc Cond \$12,000/best (313)846-5947

HARLEY 1999 HFLTP \$18,900/best offer 313-533-4778

HARLEY 1996 883 Hugger 3250 miles black \$3500 extras \$875/best Trade 248-644-3100

HARLEY ROAD KING Classic 1999 2400 miles exc cond \$19,000 firm (734) 266-8260

HARLEY 2000 Softail 1580 miles Extended warranty (248) 686-1241

HARLEY Sportster 1998 12K miles too much to list \$6500 call after 3pm (248) 683-2979

HARLEY 1997 Sportster Custom black 8300 miles \$5,000/best After 6pm 734-326-8934

HARLEY 1200 sportster 2001 jade extra chrome 1k miles \$10,500/best (810)805-3883

HARLEY 1987 Sportster 20K \$5,000 Call (248) 960-4233

HARLEY 1998 Springer 4700 miles Lots of chrome & extras Spotted \$16,000 248-360-2262

HARLEY 1989 Sprnt good cond found in old barn sat for 25 years \$1,500 no reasonable offer refused! (248)336-2819

HARLEY 1997 Standard (Road King) Belt drive 4000 miles Must sell Getting divorced \$14,600/best (248) 625-5692

HARLEY 1978 SXT 125cc 557 actual miles (collector bike) \$595/best (734) 397-1548

HENDERSON 1999 less than 200 miles Similar to Harley Fat Boy \$11,000 248-988-9934

HONDA CBR 900RR 1999 33k miles exc cond Must see! \$7500/best 248-1199-1097

HONDA 1999 CBR 900RR yellow/black stock mint 10K miles \$7100 248-476-6212

807 Motorcycles/Minibikes/Go-Karts

HONDA 1998 CBR 1100XX Low miles black \$8,000/best offer (407) 310-7689

HONDA CR250 1993 New tires silencer Good Cond \$2,200/best 248-446-0633

HONDA 750 1975 front end extension 6300 miles 9950 \$10,000 (248) 399-8955

HONDA MAGNA 1984 700CC 14,000 miles new tires exc cond \$2,000 313-622-5705

HONDA MAGNA 1983 750cc Must sell \$1500/best offer 734-276-7642

HONDA 1986 Magna 700 in exc mechanical cond 20K \$2400 After 6pm 734-421-5447

HONDA 2001 REBEL 250cc 575 miles black virtually brand new \$2,950 (248) 645-1283

HONDA 1999 shadow A CE Tourer \$5,800 1974 Sportster \$3,200 after 5pm 734-644-3279

HONDA 2000 Shadow 600cc silver 8k miles 3 year warranty garaged \$4900 734-340-4363

HONDA 1984 Shadow 8700 original miles new tires mint cond \$2000/best 734-420-3532

HONDA 1999 Shadow Spirit 1100 Black/chrome 1200 miles Garaged \$5500 810-577-5429

HONDA 1981 Silverwing 36,400 mi New tires Full dress \$1200 (248) 608-1282

HONDA 2000 XF400 Like new adult owned \$4,500/best 248-608-1428

HONDA 2001 XR200 very low miles great condition must sell best offer 248-360-2951

KAWASAKI 1974 400cc fair condition runs \$350/best offer (734) 522-5628

KAWASAKI 1995 250 Enduro only 442 original mi Perfect Make offer 248-816-1921

KAWASAKI NINJA 1997 500cc Very low mileage exc cond \$3,800 (734)981-5679

KAWASAKI NINJA EX 500 1997 Like 4.5k miles Royal Oak \$3,100 (248)947-6772

KAWASAKI 1998 Vulcan 800 7900 miles windshield back rest Exc cond \$5,350 248-394-1446 810-764-0059

MOTO GUZZI 1994 7K mi exc cond \$7500 Honda Valkyrie interstate 2000 5k mi blue \$11,000 Call Mr Keith (313)537-2000

NINJA ZX6R 1999 Green 7K w/12 helmets/leather jacket/chatterbox \$6500 (734) 421-3156

ROAD KING 1999 Police many extras 14,000 miles \$15,300/best 248-777-1754

ROADKING 2000 under 5000 miles dual power twin propane auto levers Exc cond Includes tow car \$44,000 810-227-9291

ALINER 1998 PopUp Camper sleeps 4 refrigerator heater Like new \$6,500 248-488-4884

BARTH 1986 31 Class A very good cond must sell \$11,000 below wholesale 313-582-4157

BOUNDER 1989 34 Class A 454 38k mi loaded trailer & car \$23,000 (734) 729-3711

CAMPULITE 1998 pop up with pull out sleeps 8 c screened porch excellent condition \$5300 or best (734) 266-9402

CHAMPION 1978 Bantam 17 motorhome \$3000/best Good condition (734) 513-8375

CHATEAU 1999 30 new whitelife lot membership Port Austin \$33,000 Lots available 810-752-9911

COLEMAN NIAGARA camper Toilet Shower furnace 3 way fridge awning w/ screened room sleeps 8 & much more \$8000/best 734-844-0618

COLEMAN 1993 Pop up camper Exc cond Sleeps 6 \$2600/best 248-437-7893

COLEMAN 1978 Pop up camper sleeps 6 sink stove furnace awning screened room dual power twin propane tanks spare tire \$1000 734-422-2205

COLEMAN 1988 pop up sleeps 6 canopy & screen room Good cond \$1200 248-549-0266

COLEMAN 1995 Pop up \$3900 sleeps 6 furnace screen room exc cond (248) 426-9949

COLEMAN 1999 Utah pop up camper w/slide out dinette sleeps 9 a/c heater all possible options \$8600 248-601-0139

COLEMAN 1994 Williamsburg pop up Sleeps 7 fully loaded air Exc cond Asking \$4,500 After 5pm 248-477-9250

COUNTRY STAR (1989) 29 ft fifth wheel contents included \$9200 (313) 534-8207

CUSTOM BUILT bike/utility Trailer aluminum sides Exc cond \$1000/best (248)336-2819

DAMON 1993 Intruder 32 ft loaded 42k new awning great cond \$25,000 734-944-1809

DAMON SL 1998 CampLite pop up 14 box w/slide out sleeps 8 air furnace shower toilet fridge stove screenroom \$6500 248-777-3257

DUTCHMAN 1993 Class C 27 ft Ford E 350 41k miles twin beds KT175 low dolley 4KW generator \$22,000 734-421-4273

DUTCHMAN 2000 pop up 12 ft box fridge furnace stove awning exc cond \$5,400 (734) 453-7656

ENCLOSED TRAILER 7x18 tandem axel 4 new tires needs work \$1800 (313)510-1057

809 Off Road Vehicles

POLARIS 2000 4x4 w/plow low hours excellent condition \$5900 734-453-9727

810 Recreational Vehicles

HONDA 2001 300EX Quad Runner New Red Must sell \$4,500/best (248)960-0125

JAYCO EAGLE 1998 31 slide out Exc cond many many features \$16,900 Call for details 248-624-6011 248-981-7366

RV FOR Rent by Day or Week 21ft Jayco Sleeps 6 Cali (810) 714-5325

811 Snowmobiles

ARCTIC CAT 700 (2000) 96 Woody studs only 900 miles super fast need to sell \$4,495 or best offer (248)699-7056

ARCTIC CAT ZL600 EFI 1999 & Ski Doo Mach 1 1997 w/ R&R Enclosed trailer 1999 All exc cond \$9000/best 734-414-7696

PANTHER 1988 440 Excellent cond \$3500 (248) 478-7026

POLARIS 1999 XC 600 Gen/II fully self contained fiberglass exc \$3,500 (734) 462-0046

SKI DOO Formula 500 Deluxe 1997 exc cond garage kept w/ electric start reverse and 96 studs \$3100 248-807-4027

YAMAHA 1999 SRX 600 2000 miles studded extended warranty exc cond proceed to sell \$2500 (248) 693-2315

smokers air furnace hot water tank bathroom w/ tub/shower \$14,900 (734)844-0866

JAYCO 1981 23ft sleeps 7 microwave refrigerator stove furnace air bath w/ shower full awning \$4,300 248-770-4616

JAYCO 1999 pop up sleeps 8 refrigerator stove awning bike rack \$5000 313-846-1069

JAYCO 12 Pop Up 1998 Sleeps 7 awning screen room refrigerator \$5000 248-735-8090

JAYCO 1992 pop up sleeps 6 exc cond \$2000 (734) 937-0487

JAYCO SWAN 1989 29 ft self contained with two 30 lb LP tanks & spare tire good cond \$7,000 (248) 474-7826

JAYCO 1996 5th wheel 27 1/2 w/slide out exc cond \$12,500 734-427-0562

KODIAK 2000 21 ft used once warranty \$13,500/best (734) 542-9027

LAYTON 1985 Travel Trailer 30 x 19 new tires (4) awning water heater Double bed full kitchen & bath great condition \$6000 (734) 453-7899

MALLARD 1999 25 Bunk house super clean includes hitch \$10,500 248-347-7654

MOTORHOME 1978 24ft Class A Very clean Chevy 350 New trans brakes exhaust Exc tires Special hub caps Roof air Newer fridge awning Must see \$495 248-335-6005 or 248-730-3304

OPEN FLOOR utility camper 75x76 \$400 almost new 248-363-6808

PROWLER 1999 31ft w/ slide out & warranty exc cond 3.5k miles \$16,000 248-642-0112

ROCKWOOD 2010 16' pop up camper model 1904 like new sleeps 6 furnace refrigerator stove vinyl \$3500 248-543-0004

ROCKWOOD 1995 XL pop up exc cond awning & screen room queen & double slide out beds \$4600 248-735-3933

SCAMPER 2000 fold down sleeps 8 air furnace exc cond \$5500 734-676-5508

SCAMPER 1993 Pop up stove refrigerator exc cond sleeps 5 \$1,400 248-542-0932

SOUTHWIND 1998 32 76K twin beds dual air generator basement & more Runs great clean \$16,000 248-826-7066

SPORTY FLEETWOOD 1996 30' 21k miles 460 Ford engine micro air generator very clean \$27,000/firm (248) 473-6992

STARCRRAFT 1997 like new with extras sleeps 8 awning \$4000/best 810-364-5386

STARCRRAFT 1988 pop up furnace fridge awning mint garaged \$2450 734-432-0644

STARCRRAFT 1987 pop up fridge awning sleeps 6 \$950/best (248) 328-9942

STARCRRAFT 1988 sleeps 6 Refrigerator & stove \$400/best 734-326-1096

TERRY 1999 24 FT fifth wheel w/slideout great condition \$14,250 (248) 844-8225

TERRY 1999 35 Used once Stored at Waldenwoods \$8000 734-453-5676

812 Campers/Motor Homes/Trailers

FLAIR 1989 Fleetwood motor home 27 sleeps 7 38,000 miles exc cond many extras \$23,500 734-697-4273

FLAIR 1997 30 ft motor home class A 454 Chevy 21K loaded \$33,000 248-474-7887

FOUR WINDS 1999 28 motor home 12K excellent condition After 6pm (248) 486-6441

FRANKLIN 2002 Trailer 44ft fully self contained fiberglass exc 3 electric slide outs many extras \$28,000 (248) 827-1576

FUN MOVER 1999 by Four Winds Only 3,900 miles 27th Class C Half garage half motor home Full bath sleeps 4+ all amenities Carnes 2 full size motor cycles or quads \$47,500 248-316-8400

HI LO 1989 21 ft furnace fridge stove bath awning exc cond \$5,900 734-728-6339

HOLIDAY Rambler 1994 Imperial 37.5 Ft 38K great condition \$50,000 (248) 848-1074

HOLIDAY RAMBLER Vacationer 1997 Slide out tag axle Many more extras 19 500 mi \$52,000 248-349-0227

HUNTERS SPECIAL 1976 Midas Motorhome 86K \$1100/best offer 248-634-9965

HURRICANE 1999 31 6,000 mi Fully loaded Awning generator roof air back up camera more \$44,900 734-455-9009

JAYCO 1998 26ft sleeps 8 includes power jack linens kitchen accessories & seasonal campsite in Jackson paid \$14,900 (734)844-0866

JAYCO 1981 23ft sleeps 7 microwave refrigerator stove furnace air bath w/ shower full awning \$4,300 248-770-4616

JAYCO 1999 pop up sleeps 8 refrigerator stove awning bike rack \$5000 313-846-1069

JAYCO 12 Pop Up 1998 Sleeps 7 awning screen room refrigerator \$5000 248-735-8090

JAYCO 1992 pop up sleeps 6 exc cond \$2000 (734) 937-0487

JAYCO SWAN 1989 29 ft self contained with two 30 lb LP tanks & spare tire good cond \$7,000 (248) 474-7826

JAYCO 1996 5th wheel 27 1/2 w/slide out exc cond \$12,500 734-427-0562

KODIAK 2000 21 ft used once warranty \$13,500/best (734) 542-9027

LAYTON 1985 Travel Trailer 30 x 19 new tires (4) awning water heater Double bed full kitchen & bath great condition \$6000 (734) 453-7899

MALLARD 1999 25 Bunk house super clean includes hitch \$10,500 248-347-7654

MOTORHOME 1978 24ft Class A Very clean Chevy 350 New trans brakes exhaust Exc tires Special hub caps Roof air Newer fridge awning Must see \$495 248-335-6005 or 248-730-3304

OPEN FLOOR utility camper 75x76 \$400 almost new 248-363-6808

PROWLER 1999 31ft w/ slide out & warranty exc cond 3.5k miles \$16,000 248-642-0112

ROCKWOOD 2010 16' pop up camper model 1904 like new sleeps 6 furnace refrigerator stove vinyl \$3500 248-543-0004

ROCKWOOD 1995 XL pop up exc cond awning & screen room queen & double slide out beds \$4600 248-735-3933

SCAMPER 2000 fold down sleeps 8 air furnace exc cond \$5500 734-676-5508

SCAMPER 1993 Pop up stove refrigerator exc cond sleeps 5 \$1,400 248-542-0932

SOUTHWIND 1998 32 76K twin beds dual air generator basement & more Runs great clean \$16,000 248-826-7066

SPORTY FLEETWOOD 1996 30' 21k miles 460 Ford engine micro air generator very clean \$27,000/firm (248) 473-6992

STARCRRAFT 1997 like new with extras sleeps 8 awning \$4000/best 810-364-5386

STARCRRAFT 1988 pop up furnace fridge awning mint garaged \$2450 734-432-0644

STARCRRAFT 1987 pop up fridge awning sleeps 6 \$950/best (248) 328-9942

STARCRRAFT 1988 sleeps 6 Refrigerator & stove \$400/best 734-326-1096

TERRY 1999 24 FT fifth wheel w/slideout great condition \$14,250 (248) 844-8225

TERRY 1999 35 Used once Stored at Waldenwoods \$8000 734-453-5676

812 Campers/Motor Homes/Trailers

SUNLINE 1986 34 6 ft front kitchen microwave 4 burner range w/ oven oak cabinets large tub w/ shower queen size bed full size fold out couch bed sleeps 4 adults & 2 kids air heat register in each room 22 ft awning electric lift Exc Cond member ship in Walden Woods Camp Ground included \$9,000 (248)399-4891

TIOGA 1994 Montana 22ft 22k loaded mint cond back kitchen \$20,000 (248) 673-2814

TOW DOLLY Kartote model KT175 exc cond \$625 (248)391-1194

TOYOTA 1988 Sunrailer Exc Cond 21ft 4 cylinder \$9600/best (248) 737-5748

TRAVEL TRAILER 1987 Terry Taurus sleeps 8 exc cond new tires \$8000 734-641-7938

ULTRA 1998 6700 miles one owner 31ft sleeps 2 slide outs new awning Exc Cond \$45,000 (734-416-9065)

WARDS 1989 pop up canvas tent travel trailer Sleeps 4 \$2500/best (248)595-8424

WESTPORT 96 30 5th wheel Glidout new tires & awning exc cond \$22,500 734-525-1392

WILDERNESS 1991 30 FT travel trailer bunkhouse style great cond \$6500 or best offer (734) 762-5272

WILDERNESS GL 1999 27F fiberglass rear queen large slideout sleeps 6 \$16,500 (810) 939-5722

WILDWOOD 1998 31BH bunk house in an interior park air microwave 4 corner jacks Awning AM FM exc cond \$9500 (248) 442-9536

WILDWOOD 1998 31ft bunkhouse sleeps 8 c/a heat exc cond \$11,000 (248) 363-9723

WINNABAGO 1991 Class C Warrior 88k miles rear twin bed awning micro A/C exc cond \$16,800 734-525-9372

WINNEBAGO 2000 Itasca 35ft loaded only 5K warranty \$75,000 (734) 454-4711

YELLOWSTONE 1985 Fifth Wheel 35 double bed awning new tires \$4400/best Optional tow truck 734-459-9243

814 Construction, Heavy Equipment

DAKOTA 2001 F350 Dump Truck V10 auto air 35 miles \$28,999 DEMMER FORD (734)721-2600

HUDSON 1999 Heavy Equip trailer 9 ton capacity \$4000 (810) 463-6867

LAW AUTO SALES (734) 722-5200

DAKOTA 2001 SLT Power steering power brakes air \$8500 mi \$20,000 248-693-0216

DAKOTA SPORT 1997 Very clean Loaded white extended cab \$10,500 (734)844-1747

DODGE 1996 Dakota Extended Cab auto air V 8 \$8,995

Timpani (734) 425-6500

DODGE 1994 Dakota newer transmission tires & brakes CD clean runs good \$4000/best Call Ryan 734-416-5191

DODGE 1995 Dakota Sport only 30,400 mi Arizona truck Mint cond O rust 1 owner 5 speed V6 Brand new cap AM FM cassette cruise tilt White \$7900 248-875-4103

DODGE 1998 Dakota Sport V6 22k stored winters too many extras tilt 86K in stereo upgrades \$12,600 FIRM 734-721-1164

DODGE (1992) 1500 pickup w/cap 62K loaded exc cond \$6800/best 248-474-6051

DODGE 1995 Ram 2500 Cummins Diesel 123K 4x4 astro cap \$10,800/best 734-459-3881

DODGE 1998 Ram 1500 Good cond loaded asking \$13,500/best (734) 207-8925

DODGE 1996 RAM 1500 Laramie SLT Sport Club Cab black 6 bed 5.2L V8 80K sharp well maintained \$11,500/best (734) 261-3951

DODGE Ram 2500 1995 5.9L V8 130K CD air toolbox tow package \$8200 734-323-3292

Chevrolet 1988 half ton pickup 350 auto runs good \$12,000 734-466-9270 402-889-4513

CHEVROLET 1999 Silverado LT Z71 extended cab loaded 43K \$21,900 (313) 278-0352

CHEVY 1998 C3500 Heavy Duty Silverado 5 speed extended cab chrome wheels 6.5L turbo diesel toll \$11,995

LAW AUTO SALES (734) 722-5200

822 Trucks For Sale

CHEVY 1997 1500 pickup auto air V 6 dark green with topper a great deal at \$7,980 John Rogin Buick 734-525-0900

CHEVY PICK UP 2500 crew cab 2000 Short box 4x4 5.7L auto air cd cassette all power cab bedliner trailer package 29,000 miles \$23,500 (734) 753-3832

CHEVY PICK UP 1995 Exc cond one owner 160K miles 6,500/best 517-851-8172 or 734-797-1088

CHEVY 1996 S10 black new tires 65,000 miles \$5900 Call after 4pm 248-473-2945

CHEVY S 10 1997 extended cab low 50K auto air V6 \$9700/best (734) 953-1304

CHEVY 1998 Silverado ext Cab 5.7L 2WD loaded leather 64K \$14,900 248-486-3314

CHEVY SILVERADO 1990 EXT 1 ton 87K trailer package cruise am/fm cassette 454 V8 loaded best offer 734-421-6872

CHEVY 1988 Silverado pickup low miles 1 owner fully equipped proceed to sell \$6,980 John Rogin Buick 734-525-0900

CHEVY SILVERADO 2000 Sportside absolutely perfect 118K miles excellent condition \$18,500 Call (313) 534-0114 before 11 a.m.

CHEVY SILVERADO 350 1995 V8 automatic ps pb power windows mirrors & door locks sliding rear window bedliner 118K miles excellent condition Milan \$9,000 (734) 439-2876 after 6:00 p.m.

CHEVY 2000 S10 LS auto loaded 4cyl bedliner cap 15k miles \$10,900 810-229-5913

CHEVY 1995 S10 pick up extra clean \$3500 TYME AUTO (734) 455-5566

CHEVY 1992 S 10 pick up 5 speed 2.8L V8 air 59,000 miles \$3200/best 734-425-1493

CHEVY 1989 Sportside 4 ton 4x4 rare model auto, air cruise high good miles \$6500 or best (248) 943-3060

CHEVY 1999 Suburban 1500 LT 46K loaded leather 4WD exc cond \$23,500 248-258-5202

CHEVY 1990 Tiltmaster 2 1/2 box new brakes clutch Cab Runs great \$6000 (248) 334-5008 after 5 p.m.

DAKOTA 1998 SLT Club Cab tilt cruise stereo tape fiber glass cover 30,000 low low miles \$11,995

LAW AUTO SALES (734) 722-5200

DAKOTA 2001 SLT Power steering power brakes air \$8500 mi \$20,000 248-693-0216

DAKOTA SPORT 1997 Very clean Loaded white extended cab \$10,500 (734)844-1747

DODGE 1996 Dakota Extended Cab auto air V 8 \$8,995

Timpani (734) 425-6500

DODGE 1994 Dakota newer transmission tires & brakes CD clean runs good \$4000/best Call Ryan 734-416-5191

DODGE 1995 Dakota Sport only 30,400 mi Arizona truck Mint cond O rust 1 owner 5 speed V6 Brand new cap AM FM cassette cruise tilt White \$7900 248-875-4103

DODGE 1998 Dakota Sport V6 22k stored winters too many extras tilt 86K in stereo upgrades \$12,600 FIRM 734-721-1164

DODGE (1992) 1500 pickup w/cap 62K loaded exc cond \$6800/best 248-474-6051

DODGE 1995 Ram 2500 Cummins Diesel 123K 4x4 astro cap \$10,800/best 734-459-3881

DODGE 1998 Ram 1500 Good cond loaded asking \$13,500/best (734) 207-8925

DODGE 1996 RAM 1500 Laramie SLT Sport Club Cab black 6 bed 5.2L V8 80K sharp well maintained \$11,500/best (734) 261-3951

DODGE Ram 2500 1995 5.9L V8 130K CD air toolbox tow package \$8200 734-323-3292

Chevrolet 1988 half ton pickup 350 auto runs good \$12,000 734-466-9270 402-889-4513

CHEVROLET 1999 Silverado LT Z71 extended cab loaded 43K \$21,900 (313) 278-0352

CHEVY 1998 C3500 Heavy Duty Silverado 5 speed extended cab chrome wheels 6.5L turbo diesel toll \$11,995

LAW AUTO SALES (734) 722-5200

822 Trucks For Sale

DODGE RAM 1995 1500 SLT exc cond 6 bed 5.2L V8 180K many new parts \$7000/best Must see & sell 248-366-9974

DODGE RAM 1995 SLT 2WD 44K Exc cond Warranty \$10,300/best 313-388-7716

DODGE 1998 RAM 1500 Sport quad cab V8 4x4 long bed/liner tow package loaded exc cond \$15,900 248-626-7687

DODGE 1999 Ram Sport 1500 V 8 crew cab loaded leather 45k \$20,000 (734) 464-0558

DODGE 1998 RAM 1500 sport white loaded 65K mi \$11,900 734-454-1865 313-530-5979

DODGE RAM SPORT 4x4 1996 extended cab air many extras very clean \$11,000 (734) 953-9467 after 2 p.m

DODGE RAM 1500 2001 4x4 Quad cab SLT 5.9 Liter customer preferred package 21K miles 4 yr /75K mile added cars warranty \$25,000 Call 313-730-1942

DURANGO SLT 1999 loaded 42K like new \$17,900/best (734) 502-5258

F150 2001 extended 4x4 off road power air CD nurb bars white 7200 miles \$24,300/best 248-348-2857

F150 LARIAT 1987 XLT \$3800/best Extended cab new tires exc cond (734) 522-8244

F150 1998 Lariat ext cab like new 43k Extended warranty to 75k \$18,000/best Sticker price \$31,200 (734) 451-0816

FORD 1995 Bronco Eddie Bauer Edition Runs good \$9,500 248-476-5122

FORD 2000 E450 outway van 14 ft boxed truck w/ramp air 19k miles 15K GVW assume payment 248-334-5006 after 5pm

FORD 1998 Eddie Bauer pickup auto V8 56K warranty to 100K maroon w/bedcover \$10,995 (734) 981-5927

FORD 2001 F350 Chassis Cab auto air dual rear wheels under 20 miles \$18,999 DEMMER FORD (734)721-2600

FORD 2001 F550 Chassis Cab auto air dual rear wheels under 20 miles \$18,999 DEMMER FORD (734)721-2600

FORD 1997 F150 300 6 cyl /nder 4 speed good work truck \$7500/best (734) 278-8846

FORD 1997 F150 Flare side Exc cond Super cab \$10,500 734-953-0665

FORD 2000 F150 Harley Davidson Special Edition pickup only 11K priced to sell! John Rogin Buick 734-525-0900

FORD 2001 F150 King Ranch Super crew 12,000 mi leather loaded \$35,000 248-656-4129

FORD 1999 F150 Lightning 19K

832 Antique/Classic Collector Cars

VW BEETLE Convertible 1978 \$5000 (313) 562 6233 or Call# 734 502 3880

834 Acura

ACURA 1999 3.2 TL 4 dr loaded warranty Beautiful condition (248) 851 6836

ACURA 1999 3.2 TL Exc cond Monterey blue 47K hwy mi \$21 500 (248) 360 2305

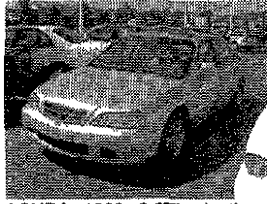

ACURA 1999 3.2TL leather low miles loaded \$23 695
RedHoban
Westland
(734) 721 1144

INTEGRA GS 1991 4dr 100k miles 5 speed a/c leather sun roof ABS Perfect college or commuter car \$3300 firm Canton Sold

3.2 TL 1999 Navigation system exc cond 68k hwy miles new tires/brakes 100 000 warranty \$22 900 248-661 8039

836 Buick

CENTURY 1988 4 dr 117K drivers iron booty carriage \$950/best 734-455 8584

CENTURY 1995 44k air power Excellent cond \$6800 (734) 421 5547

CENTURY S 2001 low miles fully equipped 3 in stock priced to sell Save now only \$14 980 John Rogin Buick 734 525-0900

GRANSPORT 1992 new in 1993 perfect for school & family car \$5200/best 248-236 9385

836 Buick

LESABRE 1995 300 Cid V8 Convertible 52K miles limited production 400 tranny body good interior needs work asking \$2 500 517 549 8385

LESABRE 1997 Custom Exc condition extra clean 87 000 miles loaded new brakes \$8700/best 734 432 2553

LESABRE 1998 Custom 45K sunroof CD good condition must sell \$11 800 734-782 9725

LESABRE 1993 great condition 52 000 miles \$5000 248 524-2577

LESABRE 1995 57 000 miles fully loaded \$7500/best offer Excellent condition!! (248) 474-5814

LESABRE 1994 runs great looks good very dependable \$3 700 313 563-4320

PARK AVE 1996 41K miles Black w/gray leather loaded exc cond \$10 900 734 459-4391

PARK AVE 1996 loaded white blue leather int exc cond 1 owner 68K \$9 500 Wixom (248) 668 0734

PARK AVENUE 1995 Exc cond 90K miles Fully loaded leather interior New tires brakes & battery (248) 466 4694

PARK AVENUE 1997 exc cond well maintained loaded sunroof leather 79K \$14 500/best 734-451 9404

PARK AVENUE Ultra 1998 31K miles sunroof leather extra clean exc cond \$18 500/best (734) 699 2994 after 5 p.m.

PARK AVENUE 1996 very clean garage kept tan leather 60K \$8900 (248) 908 5127

PARK AVENUE 1994 White/black leather Sharp 78K Miles \$7 600 (734)453 7806

836 Buick

REATTA 1989 Exc cond \$5500 734 482 2794

REATTA 1991 polo green 39K mi Stored Winters Loaded \$14 000 248 922 9822

REATTA 1989 red 100K mi good working condition \$2 900 248 851 1721

REGAL 1995 2 door cream color am/fm radio tape player new tires in January 2001 68 000 miles \$5500 or best offer (734) 425 9156

REGAL 1976 Extremely clean no rust very low miles runs great! \$5 300 (248)505 9877

REGAL 1997 GS Exc cond loaded leather heated seats 36K \$13 000 (734) 454-7386

REGAL 2001 GS 15 9K mi exc cond loaded charcoal leather seats \$16 200 248 952 5222

REGAL 1997 GS loaded leather great cond asking \$10 000 248 652 0041

REGAL GS 1999 super charged engine 28 000 miles almost every toy have to sell don't want to \$16 500 734-421 2226

REGAL 1998 36K sunroof power leather seats CD \$14 850 Troy 248 628 2994

REGAL 1984 48 000 miles 1 owner clean & well maintained light brown exc cond must see \$2 400 (313) 592 1987

RIVERIA 1995 86K dark Red/leather Turbo Wife's car garage kept \$9800 248-865-5020

RIVERIA 1995 black & black super charged CD chrome wheels heated seats 68K \$10 500/offer 734 459 7487

RIVERIA 1997 V6 sandstone taupe leather sunroof loaded garage kept chrome cond \$10 500 (248) 477 9126

836 Buick

RIVERIA 1997 white diamond V8 supercharge every available option chrome wheels spoiler & fast 65K \$14 500 248-347 4179

ROADMASTER 1995 LTD 5.7 V-8 leather 1 owner loaded! Only \$9 500 W/W!
LaRicheChevy.com
1-800-335-5335

838 Cadillac

ALLANTE 1991 Exc cond \$11 900 734-482 2794

ALLANTE 1987 Pristine Pearl White hardtop 17K Stored winters \$17 000 734 379 3844

BROUGHAM 1989 4 door 150 000 miles \$2800 248 477 1975

CATERA 1998 Loaded leather Bose CD/tape 39K Warranty \$13 950 734 427 9748

DEVILLE 1992 beige metallic fully equipped low miles priced to sell Now only \$7 980 John Rogin Buick 734-525-0900

DEVILLE 1997 Concours Ivory on Ivory loaded 42K Florida car \$19 500 810 716 8080

DEVILLE 1995 4 dr low mileage exc cond leather int nor all the extras \$12 000/best (313) 935 8234

DEVILLE 1999 DTS fully equipped priced to sell \$29 980 John Rogin Buick 734-525 0900

DEVILLE 1989 sharp must see white blue interior new tires \$4900 (734) 425 0423

ELDRADO 1984 Bantz 103K black maroon interior runs/looks good \$1 300/best. 248-553-8622

ELDRADO 1997 Black 2 door loaded 67K miles \$16 900 (248) 852 7394

838 Cadillac

ELDRADO 1999 ETC fully equipped shale metallic with matching leather interior priced to sell \$19 980 John Rogin Buick 734-525 0900

ELDRADO 1994 Northstar 63 000 miles leather good cond \$8995/best 248 442 2523

ELDRADO 1995 North Star System jade green leather mite nor power moonroof no money down \$161 mo Must be working TYME AUTO (734) 456 5566

ELDRADO 1980 47 000 original miles stored winters garage kept mint condition \$3250 248 585 7245

ELDRADO 1994 white/navy leather Northstar 103K beautiful car \$7 500/best 734 420 0278

ESCALADE 1999 fully loaded w/wrapaid Onstar 39 000 miles still under original warranty \$35 000 810 781-8657

ESCALADE 2000 Silver sand low miles On Star \$34 900 (248) 661 0012

FLEETWOOD 1989 4 door air power sunroof good tires runs excellent \$3500 734-455 1619

FLEETWOOD 1992 white diamond midnight blue leather last of its kind \$6 995

LAW AUTO SALES
(734) 722-5200

SEDAN DEVILLE 1995 blue loaded leather remote start chrome wheels perfect 79 000 miles \$13 700 313-538 1511

SEDAN DEVILLE 1989 Dependable transportation 130K \$2885/offer 248 641 9911

SEDAN DEVILLE 1992 Good cond 58k mi loaded \$6800/best offer (734) 729 3711

SEDAN DEVILLE 1987 53 000 miles Florida car runs great \$4500 or best offer (248) 486 9863

SEDAN DEVILLE 1997 32V NorthStar 49K leather good exc cond \$15 950 248 477 0600

SEDAN DEVILLE 1997 32V NorthStar 49K leather gold exc cond \$14 950 248 477 0600

SEDAN DEVILLE 1995 white diamond 65K miles immaculate cond \$9 900 (248) 883 8488

SEVILLE 1990 beautiful Texas car Exc cond \$3500/best offer 313 676 4451

SEVILLE 1983 Elegante one owner 81K actual miles leather body mechanically all excellent \$3800 248 644 6996

SEVILLE 1988 41 000 mi Must See \$7 000 248 545 5034

SEVILLE 1995 SLS black loaded sunroof must see \$8600 (248) 853 9202

SEVILLE 1995 SLS exc cond low miles non smoker \$12 900 (248) 615 1291

SEVILLE 1998 SLS white astro roof chrome wheels CD 19K priced to sell \$23 980 John Rogin Buick 734-525 0900

DEVILLE 1985 southern car no rust exc cond 78K miles \$3 800/best (248)360 2620

SEVILLE 1992 STS black loaded CD excellent cond on 78K \$8600 (734) 765 5566

SEVILLE STS 1992 Dark cherry hwy mi Must see & drive \$5295/best \$10 220 8587

SEVILLE 1998 STS white diamond neutral leather CD power moonroof chrome How about this?? \$18 995

LAW AUTO SALES
(734) 722-5200

SLS 1994 white diamond North star engine \$7500 or best offer (248) 788-3014

STS 1999 silver with matching leather sunroof chrome wheels CD 1 owner Priced to sell \$25 980 John Rogin Buick 734-525-0900

840 Chevrolet

CAMARO 1997 30th Anniversary model 1 top coupe auto 32 000 mi CD keyless entry \$11 500 Call 248 661 6756

CAMARO 1999 228 convertible black loaded leather auto 51K \$15 900 (248)496 0479

CAMARO 1995 228 Convertible mint post green saddle beige top leather 45 000 miles \$13 900/best 248 363 2637

CAMARO 1995 228 maroon clean Some fender damage \$8000 734-254 9291

CAMARO 1996 Z 28 T tops 37 000 mi Stored New tires low miles and spoiler \$10 995

LAW AUTO SALES
(734) 722-5200

CAMARO 1995 228 T tops 37 000 mi Stored New tires \$10 000 248-477 6374

CAMARO Z28 1999 every option Exceptional condition \$22 000/best 734 981 4910

CAPRICE Classic Brougham LS 1989 Black/black 100K Exc Cond \$4200/best 248 542 2725

CAPRICE 1991 Classic LTZ original owner runs great new brakes 1995 248 446 3378

CAPRICE 1989 Classic loaded V 8 low miles \$6 995

Tennison
(734) 425-6500

CAPRICE 1994 104 000 mi Been garaged Winters in Florida Extra clean \$2000 734-425-6500

CASH Dealer will sell on commission or stored New tires used car Call for cash price TYME AUTO (734) 455 5588

CAMARON 1995 auto air/ am/fm cassette ps/ps/pl 146K exc cond! \$3200 (734) 462 9832

CAMARO 1999 auto air cruise GM certified only \$8 931

LaRicheChevy.com
1-800-335-5335

CAVALIER 2001 automatic air 4 dr ABS CD 4000 miles \$11 500/best offer 734-482 7650

CAVALIER 1997 auto air cassette moon roof air cas stereo 4K miles Very Good Condition \$6 300 or best offer (248) 347 4067

CAVALIER 1999 Convertible Z 24 black beauty Summer fun! Low miles \$13 832

LaRicheChevy.com
1-800-335-5335

CAVALIER 1994 4 cyl 1.2 L auto cassette air exc tenor good exterior very reliable \$3000 (248) 652 6824

CAVALIER 1994 4 cyl 5 speed manual 60k exc int good ext \$4400 734-513-2930

CAVALIER 1997 4 door 40 000 miles ps auto cassette air \$7000 248 644 6627

CAVALIER 1984 2 door 5 speed manual 4K miles Very good asking \$4 500 248 417 6621

CAVALIER 1991 4 dr 119 000 mi \$1000/best offer (734) 306 5743

CAVALIER 1997 LS Convertible 100K \$7500/best offer speed \$7800 734 427 5385

CAVALIER 1992 new brakes needs shocks 100K \$7500/best 248 882 5784

CAVALIER 1992 red 2 dr auto air power locks 4K miles Non cond 135K \$1500 734-416-1663

CAVALIER 1998 224 coupe air cd player power package moonroof cruise premium sound & wheels 45 000 miles \$10 200 Day (248) 730 5332 Evening 248 543 9313

CAVALIER 1998 224 loaded low miles \$10 995

Tennison
(734) 425-6500

CAMARO 1996 auto air 50K \$7999 Shop TYME & Save TYME AUTO (734) 455 5566

CAMARO 1999 convertible loaded LT 1 engine exc con \$20 500 (248) 651 3475

CAMARO 1995 58K 5 speed manual V6 ABS purple premium CD rear snow tires included \$7500 248 932 3350

CAMARO 1997 Rally Sport 1 owner 22 000 miles loaded \$15 000/best 889 826 6115

CAMARO 1998 5 speed air \$11 995

Tennison
(734) 425-6500

CAMARO 1994 5 speed 95K miles green air ABS power win dows good cond dual air bag \$3500/best 248 427 9449

CAMARO 1997 30th Anniversary model T top coupe auto 32 000 mi CD keyless entry \$11 500 Call 248 661 6756

840 Chevrolet

LUMINA 1991 Euro 95 000 miles good condition many new parts \$2800 810 663-0018

LUMINA 1999 LTZ 3.8L 41K hwy miles loaded alarm key less entry well maintained \$12 495/best 313 407 6424

LUMINA 1998 87 400 mi Exc cond Power steering brakes locks A/C cruise \$2200/best 734 455 3545

LUMINA 1995 30 000 miles well cared for all power cd \$8500 (248) 446 0815

LUMINA 1997 tilt cruise power windows 30 000 one owner miles and simply perfect \$9 595

LAW AUTO SALES
(734) 722-5200

LUMINA 1991 V6 2 dr new tires of water pump runs/drives great \$2000 313-822-5705

LUMINA 1992 Z34 exc cond 2 door 109 000 miles \$4900/best 248-477 7317

MALIBU 1999 LS silver CD air auto 37 000 mi \$11 000 248 420 3523

MALIBU 2000 LS V 6 full power GM certified 6 to choose from \$12 921

LaRicheChevy.com
1-800-335-5335

MALIBU 1999 LS V6 leather cd radio cassette all power ABS \$9 750 (248) 374-6203

MONTE CARLO 1998 loaded leather moonroof 72 000 miles \$11 900 248 802 1177

MONTE CARLO 1996 LS Bur gundy 60K very clean runs great \$7400/best 734 981 3501

MONTE CARLO SS 2000 black sunroof cd/cassette loaded \$16 500 (810) 714 4024

MONTE CARLO SS 2000 loaded sunroof exc cond 21K \$20 500 248-324-1099

MONTE CARLO 1997 Z34 loaded w/sun roof New tires 62 000 mi \$8995 734-422-5929

MONTE CARLO 1995 Z34 loaded white good cond Runs great \$5900 734-454-0056

MONTE CARLO 1998 Z34 loaded \$10 995

Tennison
(734) 425-6500

PRIZM 2000 air auto power locks CD only \$9 931!

LaRicheChevy.com
1-800-335-5335

TAHOE 2000 10 000 miles exc cond \$30 000 (248) 299 9165

842 Chrysler

CHRYSLER 1999 300M Exec cond full power everything leather interior Exc cond \$17 000 248-723 6978

CHRYSLER 300M 2000 11 200 mi Silver exc cond \$22 000 (734) 421 2050

CIRRUS LX 1997 63K miles exc cond black fully loaded \$8300 (734) 954 5047

CIRRUS 1996 LX loaded exc cond \$7 000 248 788 3014

CIRRUS LX 1996 loaded leather CD 83K \$6400/best (734) 905 1613

CIRRUS 1999 LX 24 000 mi Great condition Leather CD player \$10 900 248 354-0660

CONCORD LX 1997 Loaded immaculate 23K miles Non smoker \$12 000 248 588 2116

CONCORD 1996 LX 59 000 mi Loaded \$9 600 248 646 8358

CONCORD 1999 LX Mint 34K Warranty Sept 2003 \$15 102 248 757 2023

FIFTH AVENUE 1987 silver grey leather runs good \$7500/best (734) 453 0677

JX CONVERTIBLE 1999 black 22 000 miles power steering power brakes power locks one owner garaged well main tained \$16 500 (248) 851 4372

LeBaron 1994 Convertible GT emerald green/tan loaded Very sharp dependable & fun! \$6

848 Ford

ESCORT LX 1997 4dr auto loaded 71k Miles immaculate owner \$5900 248 855 0225

ESCORT 2000 LX 4 dr s (6) auto air 7 16 000 miles from \$5,999

ESCORT 1995 LX 86 000 mi auto air exc cond \$3500 248 559-4103

ESCORT LX 1994 Wagon new engine all options exc cond \$3800 (313) 885 7967

ESCORT 2001 SE 4dr auto air, full power 7 000 miles \$10,999

ESCORT 1997 Sport excellent condition low miles \$9900 (734) 981 1596

ESCORT WAGON LX 1993 air 130k miles very good cond all power manual 5 speed runs great \$2,250 (734)459 2176

ESCORT WAGON 1995 LX auto air 126k hrs exc cond \$3500/best 734-416 1199

ESCORT 1999 X2Z (3) loaded low miles from \$8,999

ESCORT 1998 X2Z red auto matic air well maintained 35k miles \$8200/best (313) 342 0911

ESCORT 1999 X2Z red good cond 16k warranty loaded 6 cd auto \$9500 734-377 1011

ESCORT 1999 X2Z Red hot package loaded 6 changer CD power moonroof 47K highway mi \$9,900 (248) 449 9032

ESCORT X2Z 1998 Red Very good cond Power sunroof power windows 5 speed Alloy wheels \$7750 810 494-0317

EXPLORER 1998 4 dr 6 cyl air CD manual 52K miles exc cond \$13 000 (734) 748 6404

EXPLORER LTD 2000enger moonroof loaded low miles \$23,000 (248) 305-8906

EXPLORER SPORT 1998 4WD 56K \$12 000 360-317 5877 wuford@aol.com

FOCUS 2001 4 dr ZTS auto air, leather \$12,999

FOCUS 2000 1 500 miles 4 dr air keyless entry exc cond \$12 000 734-261-8075

FOCUS SE 2001 loaded green auto 14 000 highway miles non smoker clean \$14 000 or best call (734) 276 1724

FOCUS XR3 2 door stick air exc cond \$10 400 517-552 9948 810 533 3428

FOCUS X3 2001 Sangria Red Loaded Exc Cond 7k miles 248 332 7890

FOXD EXPLORER 1998 Eddie Bauer Exc cond \$12 500 best (248) 795 1780

FORD EXPLORER XLT 1998 low miles new tires exc cond \$11 500/best (248) 960-1844 after 6pm

FORD PROBE GT 1995 Rio Red, Leather seats sunroof CD manual 62K miles Exc Cond \$9 800 (248)540 8858

FORD THUNDERBIRD 1986 auto nice shape V6 \$2400 firm 248 305 5666

FORD THUNDERBIRD 1994 V6 auto 71 000 miles dark blue \$5 800 (734) 464 7709

MUSTANG 1995 5.0 black loaded 5 speed exc cond only 38K \$8900 (734) 981 8477

MUSTANG 1998 convertible black/tan clean loaded Reduced \$12 400/best 248-851 4496

MUSTANG 1998 Convertible 33K mi Fla car Very clean \$14 900 (248) 656 6776

MUSTANG 1998 Convertible LX 6900 mi \$15 300 248 642 1264

MUSTANG 1998 Convertible red V8 289 95K \$8995 (313) 575 4610

848 Ford

JACK DEMMER FORD AFFORDABLES

E150 1995 Conversion Van Hi Top TV/CR 63K \$11 995

WINDSTAR 1998 GL Wagon auto air loaded \$7 998

EXPLORER 1996 4 dr loaded 4x4 auto air loaded \$8 995

DODGE 1998 Avenger ES V 6 17 wheels CD loaded \$11 495

EXPEDITION 1998 Eddie Bauer 4x4 auto air V 8 moon \$18 995

CONTOUR 1998 SE 4 dr Sport 6 cylinder auto air moon \$9 995

EXPLORER 1998 XLT 4 dr 4x4 moon CD loaded \$13 995

VILLAGER 1997 Wagon dual air power seat loaded \$9 995

TOWN CAR 1998 leather loaded extra clean \$15 495

FORD 1997 F150 Supercab Lariat V 8 auto air leather \$15 495

E250 1998 Cargo Van V 8 case set work ready \$11 495

FORD 1996 F150 Supercab Eddie Bauer V 8 auto air \$9 995

CONTINENTAL 1993 leather loaded extra clean \$5 995

TRACER 1998 4 dr LS Sport auto air full power 33K \$7 995

FORD 1998 E150 Cargo Van V 8 auto air 42K \$13 495

WINDSTAR 1998 LX dual air aluminum wheels full power \$7 995

COUGAR V 6 5 speed CD loaded \$11 995

COUGAR XR7 V 8 39K \$8 995

TRANS AM 1995 auto CD leather T tops low miles \$10 495

CONTOURS 1998/97 starting at \$5 995

RANGER 1994 XLT 5 speed air extra clean \$5 995

SUNFIRE 1996 SE 2 dr auto air sunroof \$6 995

FORD 1994 F150 Supercab LXL V 8 auto air loaded \$8 995

TRIP 1992 V 6 full power loaded \$4 995

EXPLORER 1994 4 dr XLT 4x4 full power 68K \$8 995

CHEVY 1995 Astro Conversion Van TV/CR rear air loaded \$8 995

MUSTANG 1998 LX 6 cylinder auto air CD power seat \$11 995

DODGE 1999 Caravan full power air loaded \$11 495

JACK DEMMER FORD AFFORDABLES 734-721-5020

MUSTANG 2000 Convertible laser red 21K sharp \$21 000 734 981 8926 734-634 7087

MUSTANG 1998 Convertible V6 red/tan leather CD 30K miles \$14 000 248 476 9644

MUSTANG 1996 coupe 3.8L 5 speed sunroof new tires great cond 65K \$7500 313-819 8180

MUSTANG 1995 coupe 3.8 speed many new parts \$7500 Hartland (248) 889 8939 aft 5

MUSTANG 1997 Dream Cruise Just 1/2 year Cal (734) 692 7017

Mustang GT 1996 Convertible manual black/tan fully loaded clean many new parts \$7500 \$18 000/best 734-644-4156

MUSTANG GT 1999 Convertible black leather 5 speed auto transmission 17K miles \$21 995 248 586 0864

MUSTANG GT 1999 convertible 35th Anniversary edition White body black top fully loaded auto transmission 17K miles \$21 995 248 586 0864

MUSTANG 1998 GT Convertible black leather 5 speed auto transmission 17K miles \$21 995 248 586 0864

MUSTANG 1997 GT Dream Cruise loaded hard top 49K sacrifice \$12 500 248 933 8337

MUSTANG GT 5.0L 1994 5 speed well preserved & main tained 69K very clean \$8800/best (734) 427 6112

MUSTANG GT 1998 red con vertible tan leather interior & top 5 speed 56 000 miles \$15 000 248-223 3442

MUSTANG 2000 GT red 5 spd 11K extended warranty \$18 000/best 248 449 7831

MUSTANG 1999 Loaded V6 Auto 70K/7yr warranty low miles Best offer (734)451 5673

1998 MUSTANG low miles V6 many modifications Flow master \$10 850 (248)347 2810

MUSTANG LX 1998 5 speed good cond runs great \$3500 or best offer (313) 533 6046

848 Ford

MUSTANG 1997 Red 70K CD power windows looks great \$10 000/best (248) 755 2236

MUSTANG 1999 V6 5 speed loaded exc cond must see \$12 200 810 764-0592

PROBE GT 1994 Air 5 speed ABS V6 sunroof CD 107K miles \$9 900 (248)723 2134

PROBE GT 1993 Great Cond new tires/brakes loaded \$4000/best 248 219 1087

PROBE GT 1994 76k stick Black loaded clean 1 owner \$5500 (734) 254 0471

PROBE 1994 GT 73 000 miles 5 speed air custom side pipes & steering new brakes tires clutch \$6500 734 397 0972

PROBE GT 1995 V6 manual loaded wild orchid 68K \$4750 (734) 427 9777 after 4pm

PROBE 1996 SE auto white 72k power windows/looks great cond \$5500 734 302 2551

PROBE 1995 SE excellent condition 71 000 miles with air cassette alarm dual airbags new brakes \$5500 Must see (248) 851 4176

TAURUS GL 1997 Leather moon roof CD 39K miles \$9 950 (248)321 9749

TAURUS GL 1997 Loaded Black/gray leather 42k miles 6 CD changer all power exc cond \$9 800 (810)220 5472

TAURUS 1993 GL 3L V6 80K exc cond cranberry \$3600/best 248 324-9016

TAURUS 1996 GL 80 000 miles newer transmission \$8000/firm 248 476-3829

TAURUS 1992 GL wagon loaded tan clean good cond 130K \$1995 (734) 516 6242

TAURUS 1992 GL wagon 83 500 miles exc cond fully loaded \$5000 248 477 0221

TAURUS 1993 127K miles Runs good Looks good \$2200/best Call John 248 628 3693

TAURUS 1998 leather CD great shape \$8000/best Must see! (734)634 2677

TAURUS 1997 LS 62 000 miles loaded \$8100 must sell best offer 734 394-0789

TAURUS LX 1995 3.8 liter loaded exc cond 88 000 miles leather power everything \$5900 (248) 393 8556

TAURUS 1996 LX mint loaded leather cd 80K highway miles \$6500 or best offer (248) 360 7153

TAURUS 1999 model SHO V6 black tan leather loaded 26 000 miles \$16 900 (313) 886 9532

TAURUS 1998 new tires a/c works runs good \$11 250 Call Paul 4pm 7pm 734 422 1401

TAURUS 1998 p/w p/l 24V 48 000 miles warranty bill 2003 or 75K \$9000 734 748 0818

TAURUS SE 1999 ABS power everything 53k exc cond \$9500/firm 810 770 5340

TAURUS SE 1998 auto air full power new brakes 56000 miles \$8995 (248) 797 7089

TAURUS 2000 SE 4dr power ABS CD 22k exc cond \$12 200 (248) 594 5992

TAURUS 1999 SE 4 dr s (5) auto air loaded from \$9 995 DENIMER FORD (734)721 2600

TAURUS SE 1999 3L 24V 14 valve a/c cruise am fm cassette 19K miles \$12 400 call after 6pm 248 476 2423

TAURUS 1999 SE 3.0L 24V spoiler 16 sport wheels 6 CD 56k loaded new tires/brakes spare \$9900 734-432 2009

TAURUS 2000 SE/SES 4 dr s (5) loaded FROM ONLY \$10 999 DENIMER FORD (734)721 2600

TAURUS 2001 SES low miles fully equipped priced to sell Save thousands only \$15 980 John Rogin Buick 734 525 0900

TAURUS 2000 SE 2 to choose loaded starting at \$11 800 John Rogin Buick 734 525 0900

TAURUS SE 1995 very clean loaded 86K like new \$4200 734 454 7648 248 981 2781

TAURUS 1998 SE V6 3.0 24V Red sport group spoiler 45K \$10 200 (248) 826 4927

TAURUS SHO 1997 black tan leather 79K miles non smoker loaded great cond \$10 250 firm days (313) 832 1201 eves (248) 424 7206

TAURUS 1993 station wagon exc cond 122k hrs 706 1363

TAURUS 1997 very good cond leather seats power moonroof premium sound 82 000 miles \$7 900 (248) 345 3707

TAURUS 2000 Wagon auto air 3rd seat loaded \$11 999 DENIMER FORD (734)721 2600

TAURUS WAGON 2000 26K miles blue V6 auto air \$15 500 Call (313) 562 8415

T BIRD LX 1997 Tan leather V8 fully loaded 68 000 mi Mint \$8700 734 528 1745

THUNDERBIRD LX 1998 Black V8 moonroof loaded 110k miles Very good cond \$6 300/best (734)420 0470

848 Ford

THUNDERBIRD 1995 LX 101K hwy miles black mint Air power ABS loaded \$4500 248 865 9163

THUNDERBIRD 2002 premium convertible w/removable hardtop Just delivered to owner low VIN! Inspiration Yellow with full int color accent package (black/yellow) yellow removable hardtop Fully loaded with every option available 0 miles Collect this one! Call w/offer 9am 9pm (248)884 5923 (248)884-5924

THUNDERBIRD 1992 Sport V8 loaded very clean low miles \$5000 (734) 522 1629

850 Geo

PRISM 1996 4 dr auto air 82 000 miles \$4800 picture at www.savad.com (248) 231 5121

852 Honda

ACCORD 1994 DX auto 4 dr original owner 128K Exc cond \$5500 248 338 8806

ACCORD EX 1992 all power with moonroof exc cond 83K miles \$7595 (248) 628 1170

ACCORD 1996 EX 2 door auto leather sunroof 68k new tires/brakes 1 owner great condition \$11 400 810 829 3461

ACCORD 1998 EX loaded 40K CD sunroof \$14 250 Call (248) 549 2614

ACCORD 1995 EX V6, 4 dr sedan loaded light blue \$9500 (734) 397 9557

ACCORD 1994 EX V6 auto like new new tires/timing belt \$5 600 (734) 634 5902

ACCORD EX 1993 w/spoiler auto trans moonroof 85 000 miles \$6500 248 681 1355

ACCORD LX 2000 Black 4dr 21 000 miles \$15 300 (248) 851 8703

ACCORD LX 1988 4dr 110k miles all power moon roof CD very good cond One owner \$3 500/best (734)737 0702

ACCORD 1998 LX 3 m stock low miles priced from \$11 980 John Rogin Buick 734-525-0900

ACCORD 1995 V6 loaded 60K showroom condition \$10 500 810 919 2994

CIVIC 1997 4 door auto 66 000 miles new tires/brakes Mint \$9900 248 540 3865

CIVIC 1990 DX runs & looks great stick shift \$2900/best 313-402 0756

CIVIC 1990 DX runs & looks great stick shift \$2900/best 313 402 0756

CIVIC 1994 EX Coupe 5 speed very good condition Black 137K New tires clutch after radiator brakes AM/FM cassette cruise air power moonroof windows mirrors Maintained exclusively by Honda Have records \$4 800 (248) 546-2909

CIVIC EX Coupe 1993 5 speed loaded exc cond teal 1 owner 60K new tires/brakes/radiator \$7100 248 569 4171

CIVIC EX 1997 red 5 speed sunroof 73 000 miles 1 owner nice \$9 400 (248) 328 8711

CIVIC 1997 LX auto 38 000 mi s/e live loaded very good cond on \$11 500/or best offer (313) 945 9377

CIVIC LX 1993 116K New tires exhaust CD Exc cond reliable \$4500 248 471 8697

CIVIC 1998 1 owner 60 000 miles standard brand new tires \$12 500 (810) 764 7363

COROLLA 1998 4 dr auto air \$8 495 (734) 453 3600

SUNSHINE HONDA

6.9% ON ALL CERTIFIED HONDA'S

99 Honda Passport 21K certified \$17 995

98 Honda Odyssey EX moonroof certified \$18 900

98 Honda Accord 4 dr EX 36K certified \$14 995

98 Honda Civic 2 dr HX auto certified \$10 995

95 Honda Civic 2 dr DX auto air \$5 995

94 Honda Civic 2 dr DX auto air \$5 995

93 Honda Civic 2 dr DX auto air \$4 495

SUNSHINE HONDA

PRELUDE 1991 SI exc cond new engine 4 cyl 2.0L auto \$4900/best 734 266-6227

854 Lexus

ES 300 1993 fully loaded leather moonroof cassette 136K \$7800/best 810-725 9733

854 Lexus

GS400 1999 black loaded sunroof chrome wheels full warranty low mileage \$35 995 313 999 0207

Lexus 1994 ES 300 contemp orary style sedan classy dark green w/natural color leather interior Runs smoothly & quietly All power from steering to sunroof CD changer Priced to sell at \$9500 (248) 922 9400

Lexus 1990 ES 250 4 dr sun roof leather exc cond 70 700 miles \$9700 734 427 1429

Lexus 1991 LS400 rich silver w/blush leather All power including sunroof Magnificent premium sound system w/CD Quiet dependable spacious & luxurious Reduced to sell at \$9500 (248) 922 9400

400 LS 1999 loaded mint cond 40 000 miles new tires/brakes \$38 000 (810) 997 5074

856 Lincoln

CONTINENTAL 1996 absolutely immaculate needs nothing all options 74 000 highway miles oil changed every 4000 miles \$12 800/best (734) 397-0294

CONTINENTAL 1994 black tan leather, rebuilt motor well main tained \$4500/best 734-387 8001

CONTINENTAL 1999 buickets console CD leather luxury that's truly affordable \$14 995

LAW AUTO SALES (734) 722-5200

CONTINENTAL 2000 creme 1 owner loaded 7 500 miles \$26 500 (248) 646 4816

CONTINENTAL 1997 Exc cond 75 000 mi All options + 7 yr 100K extended warranty \$13 900 734 427 2132

CONTINENTAL 1991 Execu tive series good cond 90k miles \$2900 (248) 652 9157

CONTINENTAL 1994 Executive Series 84K good cond air power sunroof CD moonroof leather \$5495 734 397 4743

CONTINENTAL 1998 Ivory exc cond leather all power JBL Audio 85K wext warranty to 100K \$13 400 248 486 9303

CONTINENTAL 1997 66K mi exc cond loaded must sell \$12 500 (734) 495 1113

CONTINENTAL 1998 loaded \$15 995

Temperance (734) 425-6500

CONTINENTAL 1989 Signature 71K miles leather exc cond \$15 500 (734) 420 1141

CONTINENTAL 1994 white black leather moonroof \$4500 Audio 85K wext warranty to 100K \$15 500 (734) 427 1428

CONTINENTAL 1998 silver 71K miles leather exc cond \$15 500 (734) 420 1141

CONTINENTAL 1994 white black leather moonroof \$4500 Audio 85K wext warranty to 100K \$15 500 (734) 427 1428

LINCOLN 2000 LS Sport 8V loaded mint cond burgundy charcoal interior sub lease for \$462/mo or buy \$29 000 Offering cash bonus to qualify end lease 810 536 7014

LINCOLN LS 2001 V6 totally loaded moonroof 14 000 miles non smoker perfect cond \$35 000/best (734) 728 6165

MARK VII 1996 silver/gray inter or 65k fully loaded non smoker \$9500 810 574 6627

TOWN CAR 1993 black low miles exc cond \$7400 (248) 745 5106

TOWNCAR 1999 Cartier w/LaPanache top 6 CD 33k heated & memory seats leather \$24 495/best (734) 525 8237

TOWN CAR 1998 120K miles \$2500/best offer Call Timiko 313 579 1481

TOWN CAR 1993 loaded extra clean inside & out well main tained \$3200/best 313-292 5248

TOWN CAR 1997 midnight blue aluminum wheels leather CD and power moonroof too \$10 995

LAW AUTO SALES (734) 722-5200

TOWNCAR 1982 Signature Series Arizona car desert sand full power super clean must see \$4500/best 313 255 5376

TOWN CAR 1999 Signature 28K mi cd moonroof pearl white \$22 500 734 913 6206

TOWN CAR 1999 Signature Tounng Sedan Pearl White \$20 900 (810) 714-3019

TOWN CAR 1997 Signature silver/black cloth roof leather 70K \$14 000 (734) 466 9956

TOWNCAR 1988 Signature Series loaded gray blue leather \$2500/best 734 721 1697

856 Lincoln

TOWN SIGNATURE SERIES 1994 loaded cond Silver \$5790 1yr warranty w/full price All records (248) 473 6205

858 Mazda

MAZDA B2300 1994 higher miles \$3000 (248) 449 4723

MAZDA 1992 929 black leather int sunroof all options 135k good cond \$4200 (248) 375 9086

MAZDA MX3 1993 V6 1.9 liter 5 speed 75 000 miles white over gray \$6000 or best offer (248) 944 6080

MAZDA RX 7 1985 Exc cond \$2200 (248) 399 6699

MAZDA 1987 RX7 Turbo 94K miles premium sound runs great \$1500 248 344 0246

MIATA 1996 Black black top 50K miles air CD new brakes shocks & tires Well maintained \$8 900 (248)851 3059

MIATA 1999 convertible 10th anniversary special 14K Must sell \$19 950 248 620-7441

MIATA 1999 18 000 miles black 5 speed loaded \$15 000 (810) 632 7700

MIATA 1999 26 000 miles stored winters green warranty CD \$14 000 734 844-1870

MIATA 1996 Perfect Cond all black 21k miles Loaded \$14 000 (248)737 4894

MIATA 1990 red sharp low miles \$8600 Hardtop & 4 new wheels available 248 685 2983

MILLENNIA 1996 59k miles fully loaded \$12 995 (248) 669 3999

MILLENNIA 1998 S heated leather seats CD loaded exc cond \$12 900 248 735 2456

MILLENNIA S 2000 15k exc cond 2 tone paint 2000 734-455 5249 after 5:30 pm

MILLENNIUM 1995 V6 loaded sunroof \$7200 (248) 755 0682

MX 6 LS 1995 exc cond 5 speed black sunroof \$9 000 734 525 4250 or 248-466 9439

860 Mercury

COUGAR 1999 auto 4 dr air red 43K \$10 500/best Great cond 734 522 1783

COUGAR 1999 black moon roof 46K miles V6 5 speed manual \$12 000 248 582 8180

COUGAR 2000-black V6 auto loaded 14K mi sport package moonroof \$16 200 248-442 9043

COUGAR 1988 96K miles runs great \$2300 (248) 553-8144

COUGAR LS 1998 66K new wheels/tires premium sound/ CD \$3000 (248) 474 6085

COUGAR 1999 Special Edition Sporty Bronze full power CD changer rust proofed Exc cond \$13 900 248 476 6697

COUGAR 1991 V6 full power automatic cruise tilt tape exc cond \$4200 248 553 2186

COUGAR 2000 V 6 green 30K mi moon roof great condi tion \$16 000 (734) 306 7605

COUGAR 1988 XR7 fully loaded \$2200 good needs body work \$2000 248 356 1349

GRAND MARQUIS 1993 attrac tive white 4 dr exc cond all power \$4500 248 366 0495

GRAND MARQUIS 1997 Florida Estate Car \$50 000 ginal miles Loaded leather all power 2 tone tan Exc cond \$12 500 (Mobile) 248-782 2113

GRAND MARQUIS 1999 GS cruise tilt low miles \$14 200 or best offer 734 513 2407

GRAND MARQUIS GS 1998 \$34 595 7449 734-785 6037

GRAND MARQUIS 1990 83K runs good nice ride good shape \$3900/best 734-747 8937

GRAND MARQUIS 1991 low miles nice good needs some body repair power fully loaded \$1100/best 734 546 3139

GRAND MARQUIS 2000 LS (7) cloth or leather loaded from \$14 999 DENIMER FORD (734)721 2600

GRAND MARQUIS 1991 LS loaded leather new tires/brakes/exhaust \$2100 734 453 7927

GRAND MARQUIS LS 1994 39 000 miles leather all power exc cond \$9000 734-281 1099

GRAND MARQUIS LS 1992 Premium package leather lumbar A 1 \$5500 734 425-8959

GRAND MARQUIS 1996 LS Presidential Series fully loaded keyless & remote entry gray w/white top 39 000 miles exc cond \$12 900 248 538 7644

GRAND MARQUIS 1997 Very clean very good cond No salt 79 750 miles \$9600 firm (734) 722 3891 After 6pm

GRAND MARQUIS 1989 V8 rebuilt transmission loaded runs great 145K miles \$1400/ best Jim at (248) 477 9296

860 Mercury

MERCURY CAPRI 1992 con vertible Black stored winters 44K \$4500/best 248 437 9987

MERCURY TRACER 1997 5 speed 3 cd changer Fully loaded \$6100 734 495 1890

MYSTIQUE 1995 95 000 highway miles mint cond \$4800 or best 248 473 5630

MYSTIQUE 1998 Loaded V6 leather 43K miles mint cond all power \$9500 734 495 1890

MYSTIQUE 1998 Loaded V6 leather 43K miles mint cond all power \$9500 734 495 1890

MYSTIQUE 2000 LS 4 dr s (3) auto air loaded from \$9 999 DENIMER FORD (734)721 2600

MYSTIQUE 1999 LS exc cond 16K miles black V6 loaded leather spoiler war ranty \$12 500 248 661 1170

MYSTIQUE 1996 LS great cond auto V6 all power brakes new 2001 78K mi \$7000/best (248) 426 0169

SABLE 1993 Good condition ps/pb 80 000 248 647 0392

SABLE 1999 GS 4 dr s (4) all low miles from \$10 999 DENIMER FORD (734)721 2600

SABLE 1994 GS 3.8L auto air am/fm cassette cruise air loaded/mirror runs good 107K miles \$3200 734-981 7077

SABLE GS 1997 81 000 miles loaded \$6295 or best offer (734) 266 1811

SABLE 1997 58K miles fully loaded runs great dealer \$12 995 (248) 669 3999

SABLE 1999 loaded low miles \$12 995

SABLE 1996 LS 4 door only 36K miles power leather seats chrome wheels JBL stereo \$8950/best (734) 495 9913 or call 734-740 4930

SABLE 1998 4 dr fully loaded 87 000 miles exc cond new tires \$4200 248 433 1939

SABLE 2000 LS 4 dr moon auto air loaded from \$12 999 DENIMER FORD (734)721 2600

SABLE 1992 LS excellent con dition \$29K Call (734) 522 8957

SABLE 1999 LS 28K leather remote keyless 24V auto \$12 500 313 359 2367 Weekdays 734-632 5611

SABLE 2001 LS only 2 500 miles sunroof CD loaded full power \$20 000 734 729 5229

SABLE 1993 LS White loaded to built engine \$4000 best must sell 810 468-3114

SABLE 1991 Mechanics car 116K \$2200 Runs great \$8950/best (734) 495 9913

SABLE 1992 new battery new rear struts \$2995 77 300 miles (734) 453 9320 call after 5:

TOPOZ GL 1994 EXC COND 83 000 miles 4 door dark blue auto 4 cylinder 1st \$2400 must sell (313) 299 1817

TRACER 1992 auto am/fm CD new tires/short block new battery \$1300 734 981 2848

TRACER 1998 29 000 miles power windows/locks alum num runs \$9000 313 661 2336

TRACER 1995 under 68K miles good cond all power \$4 500/best (734)981 7073

861 Mitsubishi

ECLIPSE RS 1998 exc cond 42 12 disc CD w/remcpts spoiler alloy wheels \$11 000/ best 248 851 8728

GALANT 1998 ES auto air \$6 995 (734) 453 3600

SUNSHINE HONDA

GALANT 2000 ES 25K miles CD red like new \$12 300 734-844-9211

3000 GT SL 1993 auto air power 115K hwy \$7900/best (248) 969 2628

862 Nissan

ALTIMA 1998 GXE 4 dr auto black/tan a/c full power low miles \$8500 248-538-9905-213

ALTIMA 1998 SE 5 speed black 71 000 miles very good cond \$8200 734-207 0482

MAXIMA 1995 p/wpl sunroof CD/cassette 5 speed runs great \$7500/best 734 354-9454

NISSAN 1998 200 SXSE auto air red \$9 995 (734) 453 3600

PATHFINDER 1992 good cond auto 4WD Hlt cruise CD \$5800 (248) 674-7456

200SX 1988 83 000 miles loaded 5 speed \$1750 (734) 397 8639

862 Nissan

observer-eccentric.com

868 Pontiac
SUNFIRE 1997 convertible Black CD 47k asking \$9 500 Call (248) 348 6192

SUNFIRE GT CONVERTIBLE 2000 cd spoiler white with camel top/interior 11 000 miles \$16 900 (248) 335 9104

SUNFIRE 1999 GT loaded low miles \$11 995

Tennison
(734) 425-6500

SUNFIRE 1997 5 speed air \$7 495

Tennison
(734) 425 6500

TRANS AM 2000 black black leather 11 700 miles loaded 2 top 6 speed turbo \$20 500 (734) 421 8964

868 Pontiac
TRANS AM 1996 T tops auto Great summer car! Low miles \$14 500 (248)347 2810

870 Saturn
SATURN 1999 SL 2 4 door dark blue loaded auto 118K exc cond \$8 995 734 675 116

SATURN 1998 SLI silver auto 4 dr air remote entry 49K great cond \$7995 after 6pm 734-721 6618

SATURN 2000 LS 2 Sedan dk green/beige 6 cylinder loaded! 18 800 miles 1 owner non smoker \$14 500 313 441 4215

SATURN 1995 SC2 black air exc cond \$5900/best (248) 362 4590

SATURN 1997 SC2 48 000 miles 5/yr warranty red leather moonroof premium sound ABS/traction control loaded \$8900 248 584 1319

870 Saturn
SATURN SL1 1998 Auto 4 dr air AM/FM cassette 42K mi \$8100/best (248)328 9942

SATURN 1999 SL 2 4 door dark blue loaded auto 118K exc cond \$8 995 734 675 116

SATURN 1998 SLI silver auto 4 dr air remote entry 49K great cond \$7995 after 6pm 734-721 6618

SATURN SL2 1993 Sedan red auto pw/pl cassette air runs great \$3300 248 349 8246

SATURN 2000 SW 2 Silver 16 valves air auto CD 25K \$12 500 (248) 642 7494

SC2 1996 Fully Loaded sun roof 84K miles black exc cond! \$6 000 (810)776 4013

SC2 2001 loaded red under 20K miles \$13 500 734-804-9195

870 Saturn
SL 1999 clean air traction control great MPG 5 speed 39K \$8300/best 248 705 8997

SL2 1996 4 dr air auto trans all power remote entry AM/FM cassette ABS warranty \$8 000 (248)879 1038

SL2 1998 4 dr auto 46K miles air cruise remote locks 35mp/h \$6900 248 625 8271

SL2 1998 hunter green auto matric air cruise keyless entry am/fm stereo w/cd 46 000 miles Rochester Hills \$8950 (248) 608 1714

SL1 1996 67K Miles cruise air runs & looks great \$5995 (734)459 8039

SL2 1997 leather power moon loaded \$8 995

Tennison
(734) 425-6500

870 Saturn
SL2 1993 1 owner air 130K miles very good condition \$2000 (248) 349 1081

SL2 1999 5 speed ABS CD roof rack power locks/windows 23K \$9500 248 546 5783

SW2 WAGON 1998 5 speed power window & locks 58 000 miles luggage rack good cond \$9000 (734) 416 5328

872 Toyota
AVALON 1997 super clean white & tan leather sunroof CD changer 64k h way miles must see \$15 500 248 645 0535

CAMRY 1998 38k miles 4cyl ABS loaded Exc cond \$12 800 (810)714-1991

CAMRY LE 1997 California car 4 dr all power 80K hwy miles exc cond Must sell! \$10 499/best (248)330 0900

CAMRY 1990 LE 4 dr loaded 84K miles some rust \$3200 SOLD

CAMRY LE 1997 Like new in & out 35k miles Color stage \$12 500/best (313)959 5758

872 Toyota
CAMRY 1989 New battery starter alternator runs good \$2300/best 248 669 0778

CAMRY 1994 XLE \$7 995 (734) 453 3600

SUNSHINE HONDA

COROLLA 2000 auto air 31K \$10 995 (734) 453 3600

SUNSHINE HONDA

SOLARA 2000 SE V6 silver 13 000 miles premium sound system push button alarm upgrade wheels sunroof \$19 500 (734) 427 8501 or 734 525 1188 ask for Bobbie

SUPRA 1989 TURBO 78 000 miles exc cond \$6000 734 495 3589

SUPRA 1991 Turbo red \$6 995 (734) 453-3600

SUNSHINE HONDA

TERCEL 1995 57K mi 4 cyl red 2 dr air new engine \$4500/best 248 477 7341

874 Volkswagen
JETTA GLS TDI 2000 5 Speed loaded plus Monsoon sound system Must see! \$17 500 (248)360 7719

JETTA 1996 very good cond p s p b sunroof Great car for student \$5000 248-893-0216

JETTA 2000 V6 loaded sun roof 25 000 miles \$17 500 (248) 989 1165

JETTA 1994 White Security system Blue book \$5700 Asking \$5000 248 933 6512

PASSAT 1991 4 door auto moonroof full power \$3000/best 734 427 4743

PASSAT 1999 4 dr auto air real nice \$14 995 (734) 453 3600

SUNSHINE HONDA

PASSAT 1994 GLX 54K miles exc cond leather sun roof \$9 400 248 478 3918

PASSAT 2001 GLX loaded/ mint cond Silver/black leather CD sunroof heated seats more \$29 000 248 661-8898

PASSAT 2000 GLX Sedan 20 000 miles factory warranty auto leather CD power roof heated power seats Anthracite blue 17 wheels \$23 900 248 645 9482

PASSAT 1999 27 000 miles silver charcoal cloth interior \$15 900/best 248 981 5667

PASSAT 1990 new air tires belts exhaust etc 168k good cond \$3000 (248) 334-2787

BEETLE 1999 GLS White 5 Speed 24K mostly highway miles air cassette great cond \$13 750 including 4 snow tires (248) 737 4838

BEETLE 1999 GLS yellow auto black leather moonroof CD heated seats 33K mi \$13 900 248 589 8564

BEETLE 1998 red 5 speed \$12 495 (734) 453 3600

SUNSHINE HONDA

BEETLE 2000 Turbo 5 speed dark blue gray leather CD & more 14.5K miles \$18 000 313 585 9845 days 313 617 3646 eves/wknds

BETTLLE 1999 Red only 40K Miles Exc cond \$13 500 (248)706 0511 (810)558 7386

CABRIOLET 1990 white 105K mi All options \$3800 248 948 2154

CABRIO 1995 original owner leather air 5 speed 60K miles \$10 000 248 780 3273

CABRIO 1997 White convert. able tan leather all options 40K miles \$14 000 (248)203 6795

GOLF 1998 K2 Snowboard board shell in plastic 62K all original loaded superb cond 6-CD changer new tires/brakes 1 of 800 \$11 250 (248) 336 2819

JETTA GL 2000 loaded with sunroof and sound system low miles \$15 500 (248) 952 1853

JETTA 1997 GLS 5 speed w/te sunroof \$9000 or best offe (248) 686 2593

878 Autos Under \$2,000
ACCORD 1990 193K runs good/looks good no air \$1 750 (248) 486 3050

AEROSTAR MINI VAN late 1980s \$1000 or best offer (734) 522 1188

AUDI 1986 all power running exc \$1500 313 964 8040

BERETTA 1992 89 000 miles V6 \$1890 or best offer 248-363 7129

BLAZER LT 1986 4 dr loaded very nice \$3 000 \$500 \$10 000 (248) 788 0663

BUICK 1986 Century auto 4 cyl air new brakes 104k good car \$895/best 734-397 1548

1989 BUICK Century V6 auto loaded new tires Runs & drives exc \$1700/best 313 255 5376

CARS FROM \$500!
Police Impounds & Tax Refs Lists 800 319 3323 x7375

CHEVY CORSCIA 1989 4 door alarm od player \$55 as is (248) 259 6095

CHEVY 1992 Lumina 121 000 miles runs good \$1900 (248) 879 0072

CHEVY PICK UP 1971 corvette engine good parts truck \$5000 best (313)541 5150

CHRYSLER 1989 Dynasty 4 door Mint cond \$1250 519 776-6548

CHRYSLER 1987 LeBaron Station Wagon All power a/c 112K \$850/best 1989 CHEVY Caprice Wagon All power a/c 99k \$1850/best Both good condition 734 591 6424

CORSICA 1989 V6 4 dr auto 80K runs great \$1500/best (734) 844-0094

CUTLASS SUPREME 1979 great shape but needs some work Best offer 313 541 5150

DELTA 88 1989 dependable \$10000 Pontiac J2000 1983 Looks great new tires 78 000 miles new trans needs brakes \$1000 734 397 3478

DODGE GRAND CARAVAN 1991 runs/looks great V8 air cruise power windows & locks \$2000 (248)801 1806

DODGE SHADOW 1992 auto 93k miles runs great \$1000/best 248 645 5408

ESCORT 1990 G* 5 speed new tires \$1500 or best offer 810 750 1640

FESTIVA 1992 exc transportation great gas mileage \$1650 (248) 366 3238

FORD ASPIRE 1994 runs needs work \$400 (313) 541 2194

FORD TAURUS 1991 loaded clean inside & out no rust \$1700 or best offer (313) 550 8779

FORD TAURUS 1993 White 148k miles \$2 000/best Leave message (734)484 9501

FORD 1981 van \$850 or best offer 734 687 3457

GEO STORM 1990 5 speed good gas mileage runs good \$300 (248) 924 2393

878 Autos Under \$2,000
GMC JIMMY 1985 4x4 w/ a lift kit needs transfer case \$1500/best (313)541 5150

GRAND MARQUIS 1989 LS - good cond clean 131K \$1750/best (734) 455 5453

HODNA ACCORD 1987 one owner runs/looks good Garage kept \$1995 (248)478 4622

HONDA PRELUDE 1987 4 cyl - 16 valve 2dr sunroof mint cond \$850 (519) 776 6548

LEGACY 1990 LS Wagon Good transportation \$900 After 6pm 248-623-9818

LINCOLN 1983 100k new battery tires air all power works \$1 000 (248) 476 4837

MAZDA 323 1988 4dr auto, stereo mint cond \$650 (519) 776 6548

MERCURY 1989 Cougar well-maintained 127K miles \$1950/best Call 248-569 1682

OLDSMOBILE 88 1986 72K miles looks/runs great \$1900/best (734)276 2607

OLDS TORONADO 1986 \$1500 (248) 682 0898

PLYMOUTH ACCLAIM 1993 Good Cond premium speakers \$1600/best (313)541 5150

PLYMOUTH 1993 Sundance \$1350/best 248 634 3423

PLYMOUTH SUNDANCE 1989 5 speed 4 cyl good cond \$1500 (313) 541 3016

PONTIAC GRAND AM 1990 - Black fair Cond 148k miles \$1 500/best (734)595 3194

PONTIAC 1991 Grand Prix SE 4 door auto 149k miles \$2000/best offer 734-591 3838

PONTIAC 1987 Safari wagon, looks good runs good \$1750/best (248) 391 1504

SUNDANCE 1994 2 door hatchback auto runs great \$1200 (248) 545 1830

TEMPO 1991 4cyl auto air stereo low miles Mint cond \$1650 (519) 776 6548

TEMPO 1994 130k needs some work \$1 000/best Call after 7pm (734) 459 0817

TRANS AM 1985 106 000 miles 305 many options needs work \$1200/best 734 367 0620

VOLVO 1978 244 Strong motor new paint, \$1200/Best By 8 28 01 (248)420 9051

VOYAGER 1989 132K tuned at 120K many new parts air/heat work \$1800 734 513 6101

PAGE TOYOTA SALE ENDS SAT. SEPT. 15, 2001

MICHIGAN'S LARGEST TOYOTA DEALER!

2002 CAMRY LE  2001 TUNDRA SR5 4X4 

Automatic transmission air conditioning full power CD and more!

V8 four door access cab full power sliding window air automatic cruise and more \$2 500 TOTAL DUE AT DELIVERY*

48 MONTH LEASE \$229.95 PER MONTH SEQUOIA'S AVAILABLE 48 MONTH LEASE \$299.95 PER MONTH

2001 4 RUNNER SR5 4X4  2002 COROLLA 

Automatic transmission full power running boards & more! \$2 500 TOTAL DUE AT DELIVERY*

48 MONTH LEASE \$359.95 PER MONTH 48 MONTH LEASE \$149.95 PER MONTH

PAGE TOYOTA (248) 352-8580 1-800-331-9525

ON TELEGRAPH Bet. 8 & 9 Mile Rd. Hours: Monday & Thursday 9-9 Tuesday, Wednesday, Friday 9-6 Open Saturday 10-4

Visit our web site www.pagetoyota.com

WANTED

GOOD PEOPLE WITH

- Bruised Credit
- Discharged Bankruptcy
- 1st Time Buyer

A NEW CAR WAITS FOR YOU

CALL JIM SAVAGE Dealer

734-451-7104

874 Volkswagen

BEETLE 1973 auto stick new tires battery shocks carb Exc cond Best offer 734 464-8119

BEETLE 1998 Black cloth auto air cruise power windows & much more 30 000 miles \$13 900 (248) 545 5210

BEETLE 1999 GLS White 5 Speed 24K mostly highway miles air cassette great cond \$13 750 including 4 snow tires (248) 737 4838

BEETLE 1999 GLS yellow auto black leather moonroof CD heated seats 33K mi \$13 900 248 589 8564

BEETLE 1998 red 5 speed \$12 495 (734) 453 3600

SUNSHINE HONDA

BEETLE 2000 Turbo 5 speed dark blue gray leather CD & more 14.5K miles \$18 000 313 585 9845 days 313 617 3646 eves/wknds

BETTLLE 1999 Red only 40K Miles Exc cond \$13 500 (248)706 0511 (810)558 7386

CABRIOLET 1990 white 105K mi All options \$3800 248 948 2154

CABRIO 1995 original owner leather air 5 speed 60K miles \$10 000 248 780 3273

CABRIO 1997 White convert. able tan leather all options 40K miles \$14 000 (248)203 6795

GOLF 1998 K2 Snowboard board shell in plastic 62K all original loaded superb cond 6-CD changer new tires/brakes 1 of 800 \$11 250 (248) 336 2819

JETTA GL 2000 loaded with sunroof and sound system low miles \$15 500 (248) 952 1853

JETTA 1997 GLS 5 speed w/te sunroof \$9000 or best offe (248) 686 2593

874 Volkswagen

PASSAT 1999 27 000 miles silver charcoal cloth interior \$15 900/best 248 981 5667

PASSAT 1990 new air tires belts exhaust etc 168k good cond \$3000 (248) 334-2787

BEETLE 1999 GLS White 5 Speed 24K mostly highway miles air cassette great cond \$13 750 including 4 snow tires (248) 737 4838

BEETLE 1999 GLS yellow auto black leather moonroof CD heated seats 33K mi \$13 900 248 589 8564

BEETLE 1998 red 5 speed \$12 495 (734) 453 3600

SUNSHINE HONDA

BEETLE 2000 Turbo 5 speed dark blue gray leather CD & more 14.5K miles \$18 000 313 585 9845 days 313 617 3646 eves/wknds

BETTLLE 1999 Red only 40K Miles Exc cond \$13 500 (248)706 0511 (810)558 7386

CABRIOLET 1990 white 105K mi All options \$3800 248 948 2154

CABRIO 1995 original owner leather air 5 speed 60K miles \$10 000 248 780 3273

CABRIO 1997 White convert. able tan leather all options 40K miles \$14 000 (248)203 6795

GOLF 1998 K2 Snowboard board shell in plastic 62K all original loaded superb cond 6-CD changer new tires/brakes 1 of 800 \$11 250 (248) 336 2819

JETTA GL 2000 loaded with sunroof and sound system low miles \$15 500 (248) 952 1853

JETTA 1997 GLS 5 speed w/te sunroof \$9000 or best offe (248) 686 2593

876 Autos Over \$2,000

BUICK CENTURY 1990 Loaded all power family owned beautiful \$2300 248 788-0407

DAYTONA ES 1992 loader Exc cond 47k miles auto loaded \$4750 248 628 5889

GMC SUBURBAN 1987 4x4 5.7L 85-K miles runs good \$3 500/best (734)522 3745

LESABRE 1992 good cond 115 000 miles \$2800/best offer (734) 513 6030

JETTA GL 2000 loaded with sunroof and sound system low miles \$15 500 (248) 952 1853

SCORPIO 1989 V6 auto loaded 4 dr sunroof \$2300 best L voma (734) 421 6387

876 Autos Over \$2,000

BUICK CENTURY 1990 Loaded all power family owned beautiful \$2300 248 788-0407

DAYTONA ES 1992 loader Exc cond 47k miles auto loaded \$4750 248 628 5889

GMC SUBURBAN 1987 4x4 5.7L 85-K miles runs good \$3 500/best (734)522 3745

LESABRE 1992 good cond 115 000 miles \$2800/best offer (734) 513 6030

JETTA GL 2000 loaded with sunroof and sound system low miles \$15 500 (248) 952 1853

SCORPIO 1989 V6 auto loaded 4 dr sunroof \$2300 best L voma (734) 421 6387

CUETER CHRYSLER JEEP

THE CLOCK IS TICKING!

The Last of the 2001s are going fast!

WHEN THEY'RE GONE... THEY'RE GONE!

Only 100 2001's left!

2001 Sebring Coupe #10572 Was \$21,820 NOW \$18,003! SAVE \$3,817

Extra Special of The Week! 2002 PT. Cruiser Ltd. #stk20048 MSRP \$22,600 NOW \$19,736

2001 Voyager #11068 Was \$19,995 NOW \$15,650! SAVE \$4,345

2001 Sebring Sedan #10968 Was \$18,570 NOW \$15,197! SAVE \$3,373

2001 Jeep Grand Cherokee #10517 Was \$33,125 NOW \$26,993! SAVE \$6,132

2001 Jeep Cherokee #10871 Was \$26,060 NOW \$19,398! SAVE \$6,662

Closeout Used Specials!

'99 Chevrolet Malibu #P6438	YR Make Model	Stk#	Price	Payment
 Price \$11,995 \$199	'97 Ford Escort	#P6362A	\$6,995	\$119
	'98 Plymouth Neon	#P6375	\$7,995	\$129
	'98 Dodge Neon	#P6374	\$8,495	\$139
	'96 Jeep Cherokee	#0984A	\$8,995	\$169
	'98 Dodge Stratus	#P6370	\$9,700	\$159
	'97 Dodge Stratus	#P6402	\$9,995	\$179
	'99 Ford Taurus	#P6442	\$10,995	\$185
	'98 Plymouth Voyager	#P0942A	\$12,495	\$209
	'98 Jeep Cherokee	#P6443	\$12,995	\$219
	'97 Plymouth Grand Voyager	#P0988A	\$14,995	\$279
 Price \$14,995 \$259	'99 Jeep Wrangler	#P0945A	\$14,995	\$259
	'98 Jeep Grand Cherokee	#P6377	\$15,495	\$269
	'99 Volkswagen Passat	#P0078A	\$15,995	\$279

CALL TOLL FREE! 1-866-361-AUTO

CUETER CHRYSLER JEEP 2448 Washtenaw Ave. Ypsilanti

Showroom Hours: Mon & Thurs 9:30-9 p.m. Tue, Wed, Fri 8:30-6 p.m. Sat 9a.m.-4p.m. Service Hours: Mon 7:30-9:30 p.m. Tues Thurs 7:30 p.m.

www.cueter.com

*96 \$1,000 Down 66 mos. + tax. OAC **97 \$1,000 Down 72 mos. + tax. OAC ***98-99 \$1,000 Down 78 mos. + tax. OAC. All new plus tax, title and destination, rebate included, in stock only.

Suburban Satisfaction!

PONTIAC DRIVING EXCITEMENT **BUICK** It's all good! **GMC** We are Professional Grade

2002 GRAND AM SEI 4 DR. 3.4 litre V6, aluminum wheels, power windows & mirrors CD player Stk #120068 Deal #29808

2002 GRAND PRIX 3.1 litre V6, power seat Aluminum wheels, cruise, CD player Stk #120069 Deal #27809

GMS LEASE \$213 due at lease inception **LARGEST SELECTION OF GRAND AM'S IN THE AREA!** **GMS LEASE \$207** due at lease inception **\$2157** due at lease inception

2001 SONOMA EXT. CAB Air conditioning, alloy wheels, CD, cruise, 40 suspension. Stk #310350

2001 SIERRA 1500 4 DR. Vortec 4800 V8, CD, air conditioning, suspension, smooth ride. Sierra Loyalty Coupon. Stk #310384

List \$18,995* **Sonoma \$3000 Rebate** **List \$26,271*** **GMS \$14,907*** **GMS \$19,823***

2002 GMC ENVOY 4 WD, 4200, V6, power windows, locks & seats, aluminum wheels, CD player. Stk #320075

2001 REGAL LS 3800 V6, CD player, aluminum wheels, dual climate controls. Stk #210079

GMS LEASE \$337 due at lease inception **ENVOY LEASE LOYALTY** **List \$25,632*** **GMS \$18,734***

Easy Access off I-94! I-94 exit 183 Huron St.

Suburban OPEN SATURDAY 10-5:00

734 483-0322 444 James L. Hart Pkwy.

M & TH 8:30-9 TU, W, F 8:30-6 SAT. 10-5

CREDIT PROBLEMS? NO PROBLEMS! LET US HELP YOU FINANCE YOUR NEXT VEHICLE PURCHASE

MAINCENTRE

A Mixed Use Development

A beautiful complement of elegant apartment living and exclusive retail shops in the heart of downtown Northville.

Luxury one and two bedroom and loft apartments with customized features and amenities that will rival no other.

On the street level, elegant retail shops and professional office space promise the utmost in convenience.

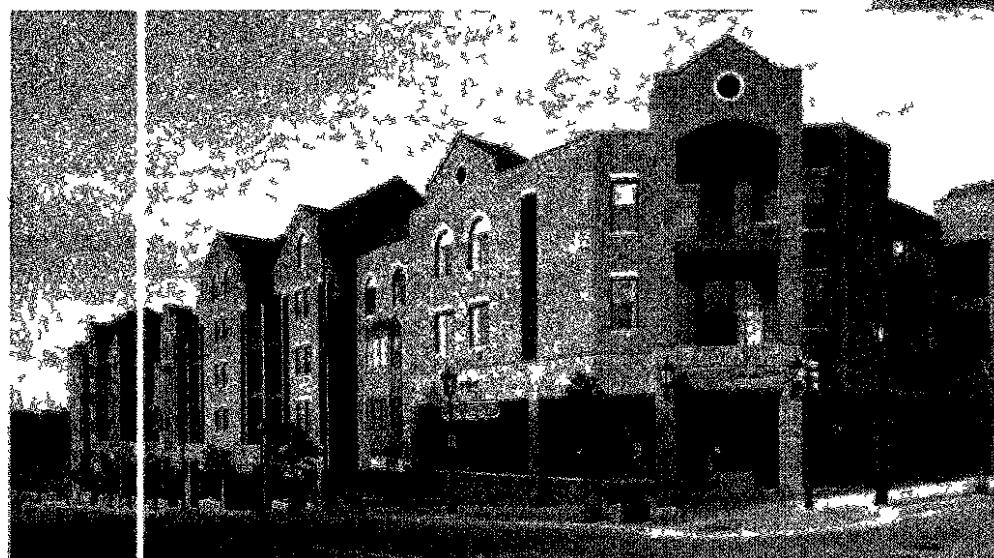

MainCentre at the corner of Main & Center Streets

SINGH
A Division of Sunstar

FOR LEASING INFORMATION:

Apartment Leasing/248.347.6811

Retail/Office Space/248.865.1600

www.singhweb.com

CADYCENTRE

A mixed-use development in downtown Northville

Across from MainCentre, CadyCentre offers unique professional office and retail space, featuring weather protected link to covered parking. Just steps way from downtown restaurants and shops.

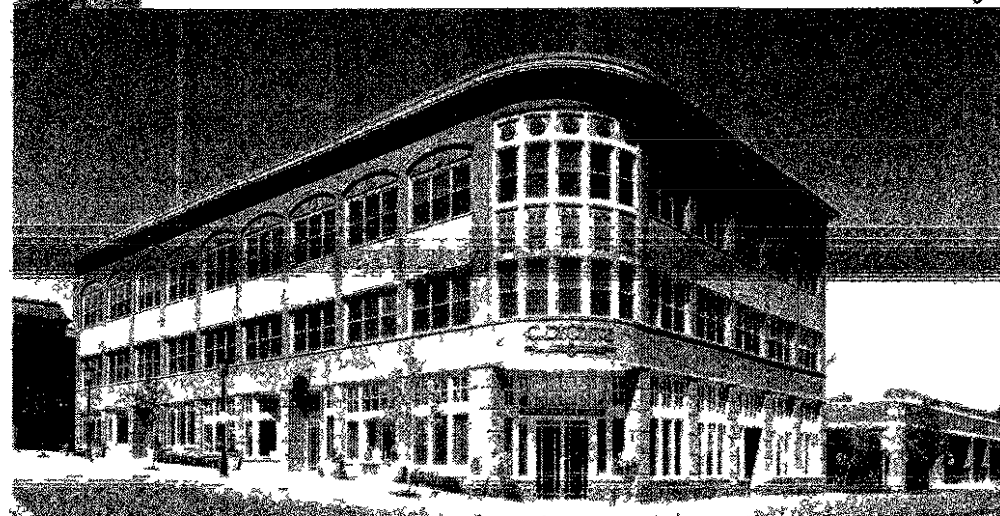

Located at the corner of Cady and Center Street.

SINGH
A Division of Sunstar

7125 Orchard Lake Road
Suite 200
West Bloomfield, MI 48322
(248) 865-1600 fax, (248) 865-1630



Daunis



An Invitation to an Exquisite Event



Orin
Jewelers INC.
SINCE 1933



Internationally acclaimed jewelry designer Patricia Daunis will be here to present her new collection for this season. Her designs have won numerous awards including DeBeer's Diamond Today, several World Gold Council Grand Prizes, and are designed to enhance a woman's features.

She will have her entire collection of earrings, earring jackets, neckpieces, pins, rings, and bracelets. Do you have stone(s) you want to remove? Stud earrings you'd like to enhance? Bring them with you - Patricia will be on hand to consult with you...and you can see for yourself how this fabulous designer turns emotion into gold.

ONE DAY ONLY!

In Northville

Saturday
September 15, 2001

10:00 AM until 6:00 PM

101 E. Main Street • Northville, MI 48167 • (248)349-6940

"Treasures From the Past"

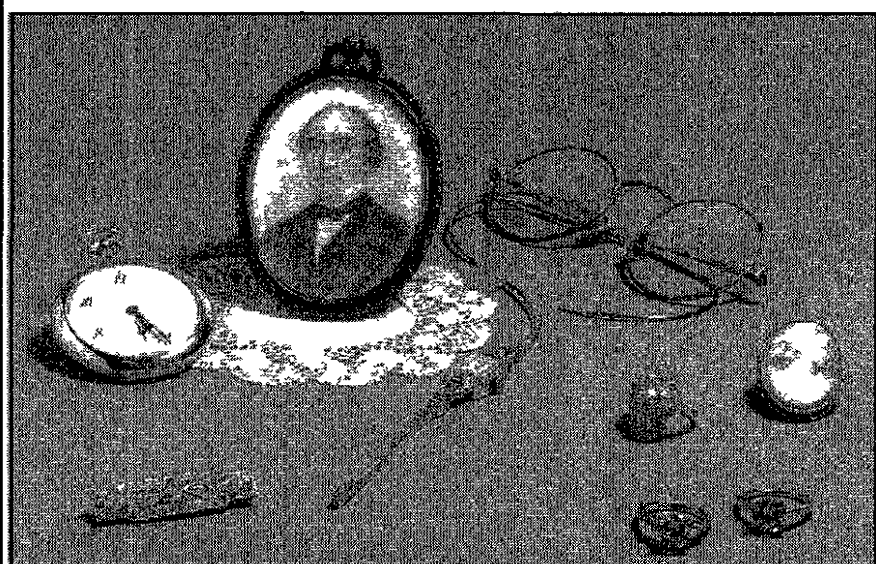

Open Daily 10am until 6pm
Thursday & Friday 10am until 8pm
Saturday 10am until 5pm

MASTER JEWELERS



Orin
Jewelers INC.
SINCE 1933



Pre view our Estate & Previously Owned Jewelry Collection during the Victorian Festival and through September 22nd
-FANTASTIC SAVINGS!-

Many items to choose from... Something for everyone!
SHOP EARLY FOR THE BEST SELECTION!

"Your Family Diamond Store Where Fine Quality and Service Are Affordable"

Northville
101 E. Main at Center Street
(248) 349-6940



sponsored by Casterline Funeral Home /
Genitt's Hole In The Wall

Dancers will have the chance to kick up their heels Friday evening following the Victorian Parade for a two-hour Contra Dance.

Cut the rug at the Contra Dance

By KELLI COOLEY
Novi News/Lake Area Times Editor

Ladies grab your shawls and gentlemen grab your suit coats. The Contra Dance at the Victorian Festival will make the skirts swing and the feet tap.

The Victorian Festival dance has been a staple to the annual festivities even if the type of dancing and the name has changed.

A Victorian Ball had visitors and residents waltzing to music in their finest attire for many years. However, last year it was decided to try a country dance due to the ball's lack of attendance.

Although the country dance appealed to guests in the dancing arena, participants missed dressing up.

This year's Contra Dance combines the best of both worlds. Participants may dress up or wear comfortable clothing while dancing to the sounds of caller Robin Warner and the Ruffwater String Band, said Chamber of Commerce director Laune Marrs.

Marrs said a Contra Dance is an elegant square dance.

"It's rather easy. You join hands and have group dances," Marrs said.

Even inexperienced Contra Dancers can participate, Marrs said, following the caller makes it easy.

This year's dance will be held on Friday, Sept. 8 from 8 to 10 p.m. on Main Street, right in front of Genitt's Hole in the Wall.

"People can come observe and try it. It instills enthusiasm."

Laune Marrs
Northville Chamber of Commerce

the Wall Theatre. The dance is also sponsored by Genitt's and Casterline Funeral Home.

Open to anyone willing to give it a try, the dance is an important part of Victorian history.

"It's free to participate. People can come observe and try it. It's a very important part of the Victorian era. It

instills enthusiasm," Marrs said. Guests and participants are free to bring their children as well.

The difference with the Contra Dance is also the setting. There is no sit-down dinner, however, Marrs said, guests can enjoy the food from the non-profit organization's booths and then join in on the fun.

For more information, contact the Chamber of Commerce at (248) 349-7640.

Kelli Cooley is the editor of the Novi News/Lake Area Times. She can be reached at (248) 349-1700 ext. 113 or at kcooley@ht.homecomm.net.

. décor & furnishings . to make your house a home

. gifts . that you'll love giving

. casual apparel . for work or play



mc . visa . discover . amex
extended festival hours

120 North Center Street
248.349.0199 . Northville

RE/MAX
CLASSIC
REALTY

38777 Six Mile Rd.
Livonia, MI 48152

248-477-1010 • 734-432-1010

NANCY BOCK
The Hat Lady

RESIDENTIAL REAL ESTATE COUNSELOR

Let me help you find your way to a new home!
Confidential information is kept under my hat.

Sincerely,
Nancy Bock

Email: nbock@remaxclassic.com

Full Service Quick Oil Change

- Oil Changes
- Wiper Blades & Refills
- Headlamp Replacement
- Tire Repairs
- Tire Rotation & Balance

Your Complete Auto Service Center

DAVIS
AUTO CARE

- Guaranteed Repairs
- ASE Certified Technicians
- Customer Service #1
- Free Shuttle Service
- We Do it All
- Domestic, Import, SUV, Pick-up and Van

(248) 349-5115

807 Doherty Dr., Northville, MI
Visit Our Web Site
www.davisautocare.com
E-mail: service@davisautocare.com

"Where a brilliant finish is just the beginning..."

Ultimate Image
AUTO SPA

- Vehicle Detailing
- Hand Washing
- Interior Cleaning
- Fabric Protection
- Exterior Buffing & Polishing
- Hand Waxing
- Windshield Chip Repair

AUTO DETAIL CENTER
(248) 349-3509

E-mail: autospa@davisautocare.com

Recycle **HOME TOWN**™

Non-profit groups offer eats, games

By CHRIS C. DAVIS
Editor

Just in case Mother Nature tries to pull a fast one this year Diane Villeneuve is readying her non profit concession booth troops

"We've got everything from coffee to slushes," said Villeneuve organizer of the non profit booth portion of the 13th annual Northville Victorian Festival "We're going to be ready this year

More than 30 booths representing a variety of community religious and civic organizations will be out in force for the festival The booths provide many of the festival goers with the food and drink they're looking for as they stroll through the streets of downtown Northville

But it's not just refreshments the vendors will be offering Villeneuve said In several cases what's being sold goes beyond something to fill a stomach or quench a thirst

"We have two new raffles this year" Villeneuve said "One is for a pair of airline tickets to fly anywhere in the lower 48 states and the other is for a Thomas Kincaid picture They're both great prizes"

Of course if it's nachos hamburgers

soft drinks or candy that residents and visitors are searching for those items will be out again this year Villeneuve said

"The Coke and Pepsi products are always popular" she said "We're adding a milk shake stand as well as a vendor who sells root beer floats

Villeneuve said the non profit groups participating in the three-day festival will be dressed up and decorated in Victorian garb not just to be in step with the theme of the weekend but also because the group with the best decorated booth will have its registration fee for the 2002 Victorian Festival

waived

"We're really pushing for people to dress up and decorate" she said "That's so much of the fun of this event Seeing people get into the theme is what makes the Victorian Festival so special for those who attend it."

The winning booth will be noted with a large blue ribbon Villeneuve said

Chris C Davis is the editor of the Northville Record. He can be reached at (248) 349 1700 ext 114 or at ccdavis@ht.homecomm.net.

NON-PROFIT CONCESSIONS / ACTIVITIES

GROUP

City of Northville fire department
City of Northville fire department
Northville Civic Concern
Kiwanis Club
Kiwanis Early Bird
NHK Class of 2002
NHK Class of 2003
NHK Class of 2004
NHK Music Boosters
NHK Pom-pom
NHK Rotary Interact Club
Northville Chamber of Commerce
Northville Chamber of Commerce
Northville Christian Assembly
Northville Co-op Preschool
Northville Lions Club

Northville Lodge No 186
Northville Lodge No 186 Rainbow Girls
Northville Mothers Club
Northville Rotary Club
Oak Pointe Church
Plymouth Figure Skating Gems
SAI D

St Paul Lutheran Church

Firs United Methodist Church
NHK junior varsity pom-pom

Northville Arts Commission
Northville Co-op Preschool
Northville Junior Baseball / Softball
Northville Public Schools Early Childhood Center
Oak Pointe Church
Plymouth Figure Skating Gems

BOOTH

Turkey legs
Popcorn / cotton candy
Pepsi products
Italian sausage
Coca Cola products
Pizza
Kettle popcorn
Nachos
Root beer floats
Bottled water
Cracker Jack / animal crackers
Wrap sandwiches
Sandy candy
Apple dumplings
Juice boxes
Ice cream bars / potato chips / pretzels
Corn on the cob
French fries
Slushes / candy / hot chocolate
Hot dogs
Hamburgers / milkshakes
Walking tacos
Chocolate covered caramel corn / lollipops
Pies

Cake walk
Goldfish game (2 airline tickets raffle)
Art market
Basket raffle
Dunk tank
Wooden rolling ball game
Thomas Kincaid picture raffle
Victorian music box raffle

Welcome to the 13th annual Victorian Fest

On behalf of the Northville Chamber of Commerce and the entire Northville community welcome to our 13th annual

Victorian Festival sponsored by Cambridge Homes Over the past years this festival has doubled in size and popularity As you can imagine our staff and volunteers have worked many long hours to ensure you and your family have an enjoyable time



Laurie Marris

The kick off parade begins Friday at 6:30 p.m. followed by entertainment and a Victorian Contra street dance The next day take a leisure stroll through town and visit the art market the antique show participate in the children's games and rides sample the deli-

icious food at the non profit booths listen to the many bands and musicians take a free horse and carriage ride a mmm train ride and watch the outstanding entertainment throughout the streets There is something for everyone regardless of age or gender Due to our generous corporate sponsors all acts are free of charge Be sure to check the complete list of activities times and locations within this booklet

As you walk through town notice that every effort has been made to preserve our rich Victorian heritage The refurbished storefronts historical buildings and the well maintained streetscape are evidence of our commitment I know you'll agree — Northville is a city with a beautiful past and a promising future Please come visit us again

Laurie D. Marris
Executive Director

Northville
Chamber of Commerce

For the most Heavenly Gifts on Earth, Visit...

Michael's ANGEL ATTIC

Come Celebrate Our
GRAND RE-OPENING
Friday-Sunday, Sept. 14-16, 2001
10 a.m. - 5 p.m.

The Angels have relocated to Downtown Northville!
125 E. Main Street • Northville
(248) 449-8890
Hours: Monday - Thursday 10-6
Friday 10-8 • Saturday 10-5

Stop by and Meet
Our Resident Angel
& Receive 10% OFF
your purchase with this ad!
expires 9/17/01

Homes showcase history in Victorian tour

By LON HUHMANN
Staff Writer

Historically speaking there are many homes in Northville worth getting a better view of and in turn a better knowledge of the Victorian era

Interested residents and visitors have the chance to view five homes in the city of Northville that are a century old The Northville Novus branch of the American Association of University Women (AAUW) is sponsoring its seventh historic home tour of Northville on Saturday Sept 15 from 10 a.m. to 4 p.m.

According to the AAUW's publicity Chair Carol Welsch the historical home tour has been the most successful and important fundraiser for the Northville Novus branch since 1995

Welsch said all five homes have historical significance but have been properly renovated to meet modern day standards The tour will cover a walking distance of 1.5 miles in the historical district in the western section of the city

"The historical home tour gives people the opportunity to get an even better feel for and glimpse into Northville's Victorian past AAUW local general chair Barb Wilson said

There are two tour homes located on Randolph Street According to Welsch the home located at 562 Randolph was a part of the land deeded to A. Aldrich in 1825 by President John Quincy Adams The home is believed to have been built in 1868 for the Steenken family and was the original farmhouse for the area Welsch said the original structure had very little



Photo by LON HUHMANN

Homes like this one will be available for viewing during the Victorian Festival's historic home tour.

trim or ornamentation leaving the current owner a decorator with a blank canvas

"The owners have doubled the size and extensively changed the interior" Welsch said "A new garage and carriage house above it have been added"

The other home is located at 124 Randolph and is believed to have been built in 1873 for Willard Stark Welsch said the home is an example of Carpenter Gothic

Northville's most notable events In 1959 a military training jet crashed across the street from this home and bits of debris flew all over the area including a piece which went through the front window of this home

The last home on the tour is at 549 W. Dunlap Street and it is believed to have been built in the late 1800s This home served as the parsonage for the Northville Methodist Church from 1939 until 1957

Tickets can be purchased at Gar denviews 202 W. Main Street and Morrison's Antiques at 105 E. Main Street Prices are \$10 per person pre sale (must be 12 or older) and \$12 per person the day of the tour if any are left Welsch said tickets could sell quickly considering the past success the tour has had

Tickets also act as a program guide including a picture and brief description of each home Welsch said there are several requirements for tour participants and they are shoes must be removed when entering a home and no bare feet In addition interior photos smoking and children under 12 are not permitted

Welsch said the proceeds from the event support the activities of the branch The activities include two endowed scholarships for women at Oakland Community and Schoolcraft colleges Local projects have included a Gender Equity Project at Amerman Elementary school and the science camp for girls

Lon Huhmann is a staff writer for the Northville Record He can be reached at (248) 349 1700 ext 109 or by e-mail at lhuhmann@ht.homecomm.net

Opening the door to hope

The Muscular Dystrophy Association's support services help Americans live with 40 neuro-muscular diseases And our cutting-edge research offers hope for a future without these disabling disorders

Call our lifeline It's toll-free
1-800-572-1717
www.mdausa.org

MDA
Muscular Dystrophy Association

TABLE OF CONTENTS	
Street entertainment overview	4
Mill Race activities	4
Northville schools activities	5
Street entertainers	6, 7, 8
Victorian dress	8
Victorian Walk	10
Schedule of events	10
Art market overview	11
Art market participants	11
Box lunch auction	11
Victorian parade / map	12
Victorian trivia	12
Non-profit concessions / activities	14
Historic home tour	14
Contra dance overview	15

HEALTHY SOLUTIONS

Living better Naturally
the way it used to be

Vitamins ♦ Herbs ♦ Health food ♦ Bath & Body

Nutritional Herbalist / R.N. / A.T.C.
150 Mary Alexander Ct.
downtown NORTHVILLE
☎ 248-305-5785
15% OFF with this ad

LONG'S

Fancy Bath Boutique

Long Plumbing Co. & BATH DESIGN CENTER

We offer you:

- Decorating and accessory showrooms located in downtown Northville
- A large selection of bath accessories and fixtures.
- Bath design and remodeling project assistance.
- Plumbing service and repair since 1949 by Long Plumbing Company.

190 E. MAIN ST.
NORTHVILLE • (248) 349-0373

Entertainers dazzle crowds with old talents

By DIANE DEMPSEY DEEL
Staff Writer

The Northville Victorian Festival will capture the heart of the yesteryear by providing plenty of old fashioned entertainment that will delight young and old.

Eugene Clark, one of the coordinators for entertainment, said that there is a huge line up of performers who are looking forward to amuse festival visitors.

Clark's family will be a part of the entertainment festivities along with many other performers. Clark booked for the festival.

Clark, his mother Mary Ellen and brother Chris will entertain visitors with their respective blend of performances.

Clark will be doing a Punch and Judy puppet show, which was popular in England about 200 years ago.

The puppets have distinctive hooked noses that is bound to make people laugh.

The show in England was often violent. However, this show is a kid friendly show that is sure to please everyone.

It got started in England with the common people," Clark said. "This was their entertainment that dealt with issues happening in their city and dealt with politics."

The issue that kids will be dealing with at Clark's show will be to solve the mystery of the missing flower.

"I changed it and turned it into a children's show that's going to be a feel good show for kids," Clark said.

Chris Clark will put on a show that will amaze onlookers.

"He will do a show that consists of juggling and magic," Clark said. "Both he and his partner Ken will juggle six fire torches while Ken rides a unicycle."

Mary Ellen Clark will entertain young visitors by giving impromptu story telling performances.

"You will see her stroll the streets with a large puppet that looks like a goose," Clark said. "She looks like Mother Goose."

"It's a little more low key and it gives parents a chance to relax," Clark said.



Photo by JOHN HEIDER

The Victorian Festival has entertainment for young and old alike — such as this balloon artists who crafted creatures for kids at the corner of Main and Center in 1998.

"It's like going to the library and having a book read. It gives you a really good feeling."

Visitors will get a kick out of Spoon Man of Grand Rapids who makes his own kind of music.

"He will keep an old fashioned tradition alive by playing a set of spoons that creates a fancy rhythm to music," Clark said.

The Boogie Woogie Babies will make people jump, jive, and wail with their upbeat blast of sound.

"It's a music review featuring the fabulous harmonies of the Andrews Sisters," Clark said.

A ventriloquist Richard Paul is sure to please visitors, he said. He will make people laugh with his funny puppets, he said.

"He's a positive performer," Clark said.

Then there's magician, Chris Linn who will keep people wondering how he does his surprising capers.

"He will amaze and astound while keeping you laughing," Clark said.

Another popular musician, Chauqua Express, has been away from the festival for a couple of years. However,

he has been brought back by popular demand.

"He is a dynamic musical performer who gets everyone involved in the show," Clark said. "It's a great show for all ages."

Clark's looks forward to the festival every year.

"I feel that the 2001 festival will be bigger and better than ever," Clark said.

Diane Dempsey Deel is a staff writer for the Lake Area Times. She can be reached at (248) 349 1700 ext 110 or ddeel@ht.homecomm.net.



An entertainer on a three-wheeled unicycle captivates a Saturday afternoon crowd at the corner of Main and Center during the 2000 Victorian Festival.

A NEW THERAPEUTIC MASSAGE

We have a staff of professionals who specialize in a variety of techniques and are trained to work with you to accommodate your needs with professional bodywork.

- Swedish Massage
- Shiatsu
- Sports Therapy
- Myofascial Release
- Pre Natal Massage
- Geriatric Massage
- and more

Personalized Bodywork Created Just For You

Hours
Mon-Fri 8am-8pm
Saturday 8am-4pm
Call for an appointment

*145 East Cady
Northville (Behind Sizzler's)*
248 449 2639

Family Restaurant

Ice Cream Parlor

\$100 OFF
Any Purchase
Of \$5 Or More

With Coupon Only. Coupon May Not Be Combined With Any Other Offer. Not Valid With Any Other Offer. Expires 3-31-02.

Breakfast Special
\$2.99

Mon-Fri, 8am-11am
2 eggs, choice of meat,
potatoes & toast

With Coupon Only. Coupon May Not Be Combined With Any Other Offer. Not Valid With Any Other Offer. Expires 3-31-02.

- Homemade Soups
- Sweet Potato Fries
- 32 Flavors of Ice Cream
- Colombo Yogurt
- Friday Night Fish Fry
- Smoothies
- Sanders Hot Fudge Cream Puffs

**134 N. Center St.
Downtown Northville**
248-348-2660

Race to Mill Race for a trip to a year gone by

By JENNIFER NORRIS
Staff Writer

The instant area residents step into Northville's Mill Race Village they will be magically transported back through the pages of history.

During the Victorian Festival on Sept. 15-16, the Mill Race Village will be buzzing with plenty of activities and games to entertain both young and old alike.

The historical village area will be open from noon to 4 p.m. on Saturday and Sunday.

According to Laurie Marrs, executive director of the Northville Chamber of Commerce, the historical buildings will be open for public access on Saturday and docents will be available to give tours and provide information.

On Sunday a variety of activities and events are slated to take place.

Marrs said that Victorian era reenactors will be present at Mill Race Village and spectators will see a representation of what life was like during that time period.

"They set up a camp just like they would have done back in the 1800s," she said. "It's like you just took a step back in time."

Costumed reenactors will have tents and campfires set up which will be accented by the historic buildings.

"They set up a camp just like they would have done back in the 1800s."

Laure Marris
Northville Chamber of Commerce

close by. Reenactors will also be busy doing ordinary daily activities symbolic of that time period such as cleaning their guns or preparing meals, said Marrs.

Along with the reenactors, a variety of old-fashioned games will be available for children. Such games include sack races, marbles, and hoop throwing.

In addition, Marrs said the duck race will begin at 3 p.m. and has become a popular event at the Mill Race.

She said children can come to register for a free plastic duck which will then be placed in the river to race. Marrs said prizes for the duck race include gift certificates from Northville merchants.

An authentic string band is also slated to provide entertainment for area residents in the gazebo.

"They play all afternoon," said Marrs. "They're beautiful and they're all in uniform too."

Women will also battle for acclaim in the Ladies Victorian hat contest.

The event will take place at the gazebo and is open to those wearing an authentic Victorian hat. Judges will award prizes for different categories including most unique hat, most colorful and most creative. Prizes include gifts that have purchased from Northville merchants, said Marrs.

Snack foods will also be for sale including old fashioned sarsaparilla.

In addition, caricature artists will be on hand at the Mill Race Village on Sunday.

Marrs also said one of the most important aspects that enhances the popularity of the village is visitors bring the box lunch that they purchased at the auction and enjoy it while relaxing at Mill Race Village.

Marrs added that the Mill Race Village is an ideal location for a portion of the Victorian Festival due to its historical significance.

"We're very fortunate," she said. "Not every community has that. We call it our own little Greenfield Village. I definitely thank the Northville Historical Society for their vision years ago when they came up with the concept. You can't ask for anything more."

Jennifer Norris is a staff writer for the Northville Record. She can be reached at (248) 349 1700 ext 107 or by e-mail at jnorris@ht.homecomm.net.

Helen's Uptown Cafe

invites you to join us during the Victorian Festival

Enjoy our air-conditioned Dining Room or visit us in the Food Court

Eat Better Food!

Salads - Sandwiches - Seafood

Pasta - Soups - Quiche

160 East Main - Next to the Gazebo
(248) 449-4040

50% off any entree
Lunch or Dinner

with purchase of equal or greater value
Monday-Saturday 11am-9pm
expires 9/30/2001

Reserve our dining room for your next private party

Open Monday through Saturday 11am-9pm

The Sawmill

Home of SOLID WOOD FURNITURE

3063 Biddle, Wyandotte • 316 North Center, Northville
734-285-8477 • 248-349-8585

Celebrate The Victorian Festival with Queen Sized Savings at The Sawmill!

The Sawmill

Victorian Festival Sale

10% OFF

All Furniture Purchases
September 14, 15 & 16 2001 Only Excludes Custom Finishing

Victorian parade kicks off weekend

By DIANE DEMPSEY DEEL
Staff Writer

Northville residents will get to see their friends and neighbors dressed up in costumes from years of yore at the parade that will kick off the Victorian Festival.

The Victorian Parade sponsored by Angela Carson Photography will begin and end at the Recreation Center and Old Village School parking lot on Cady Street.

The parade will begin at 6:30 p.m. Sept. 14 where people will be lined up to revel in the merriment.

The parade will exit the Recreation Center lot to Cady, then it will proceed down east Cady to Wing Street. The parade will turn north on Wing and proceed to Main.

Then it will turn west on Main to Linden then north on Linden to Dunlap. It will then proceed east on Dunlap to Hutton where it will go west on Main to Center until they turn west on Cady and end up back at the center.

Laurie Marrs, executive director for the Northville Chamber of Commerce, said people look forward to the parade every year.

"It's a kick off to start the whole festival," Marrs said. "The atmosphere is crackling. It's the beginning of the party for the whole weekend."

Donna Pallace, parade organizer, said people who attend the parade will get the chance to be entertained by three bands this year.

The Caber Feidh Band will capture the sounds of Scotland with bagpipes while everyone will be delighted to see the Northville High School band play their tunes.

The Fife Drum Corps will be another band that will pump up the crowd.

"It's kind of a nice variety of music," said Pallace.

People will not see floats at this parade, she said.

"It's different than most typical parades because there are no motorized vehicles," Pallace said. "It's made up of pedestrians who are from the schools, scout troops and civic groups."

St. Paul's Lutheran School will have a good size group of participants in the parade, she said.

People will get the chance to see the woman who is helping to make the parade a reality.

Carson is not only sponsoring the parade, but she will be in a survey that

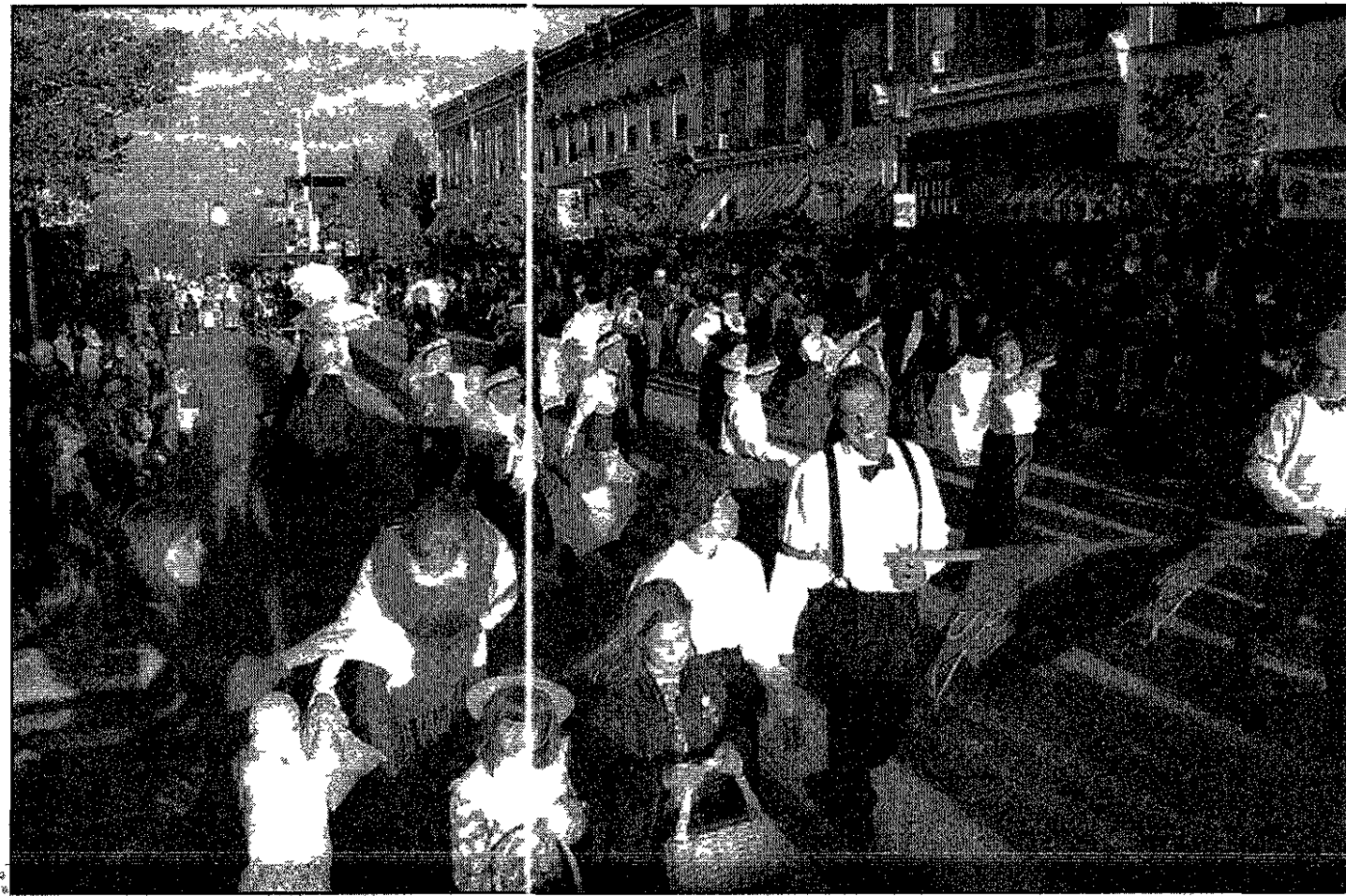
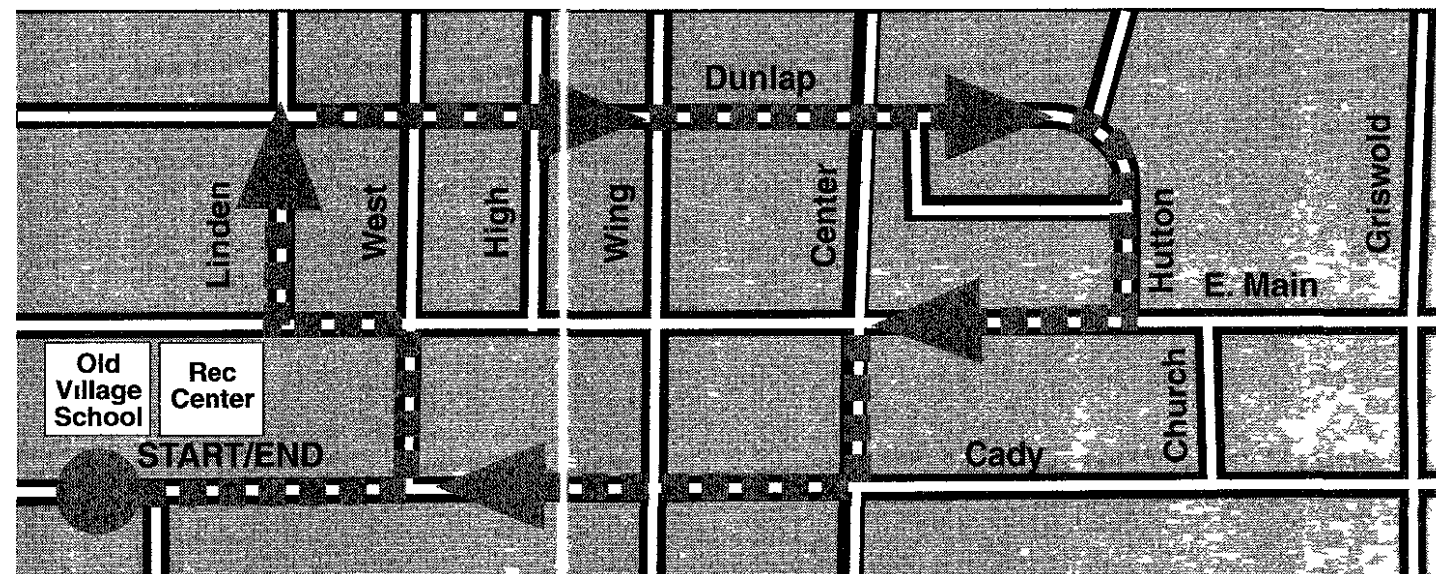

Photo by JOHN HEIDER

Marchers move west along Main toward Center Street in last year's Victorian Festival parade

Victorian Festival Parade Route



is filled with her family and friends.

The Queen of the Victorian Parade will wave to the festive crowd as the last carriage to go through the procession.

People can look forward to seeing an old-fashioned trackless tram that will be filled with people in yesterday's wear.

"We have different folks who bring their horses and the riders appear in period costumes," Pallace said. "The kids really enjoy that."

The people who are participating in the procession have a good time and it's sometimes interesting following behind the horses, she said.

Children will get a kick out of dressing

as children did in the Victorian era and the crowd will enjoy waving to them as they pass through the procession.

Local officials from Northville and Northville Township will be away from their chambers and ready to cheer with the crowd as they make their way through the affair.

Marrs said business women will be putting on a show with their Parasol Brigade.

"They get together with Victorian parades and do a routine," Marrs said.

People will step back in time when they see "President Abraham Lincoln" and his wife "Mary" participate in the

parade, Pallace said. "The crowd will laugh when they see people decked out in clothing of the Victorian era peddling bikes with oversized wheels."

"What drives people to the parade is they have fun seeing their friends and neighbors dressed up in costumes from 100 years ago," Pallace said. "I love playing dress up. The hunt for the costume is the most fun of all."

Diane Dempsey Deel is a staff writer for the Lake Area Times. She can be reached at (248) 349-1700 ext. 110 or dddeel@ht.homecomm.net.

Students get fun education in Victorian era

By JENNIFER NORRIS
Staff Writer

History will literally come alive for Northville's third grade students Sept. 14.

Jan Purtell, education partnerships supervisor for Northville Public Schools, said that the district's third grade students will be rotated through five different historical activities in the morning. Each of the elementary schools will have a different rotation order which will allow the third graders to more easily participate in all five planned events.

Purtell said the activities will begin at 9:30 a.m. and each event will last for 20

minutes. A 10-minute passing time will separate each of the five activities.

One of the stations that the students will visit is the Northville Parks and Recreation Center where a variety of old-fashioned Victorian games will be played.

Purtell also said there will be an interactive performance at the gazebo.

Entertainment will be another station the students will visit. Purtell said this activity is planned to take place at Gentile's Little Theater depending on weather conditions.

Another activity is storytelling which will take place at the library.

Students will also be able to take a walking tour of the historic district of

Northville located in front of the board offices. Purtell said on the tour of the historic homes, one English class and one social studies class from the high school will be performing various skits for the third graders.

"They come up with some pretty creative things," she said.

The third grade students are expected to be back in their school buildings by 1 p.m.

"Our main focus is for the history of Northville to come alive for [the students]," said Purtell. "It's a fun way to learn a lot of history and have them participate at the same time."

Purtell also said on September 7, three

speakers will be coming to the high school to provide students with helpful information to prepare them for the Victorian Festival. She said one speaker will address the topic of costumes, another speaker will discuss Northville's history and the last speaker will instruct students on the mechanics of putting a skit together.

The third grade students she said will be transported to a trip to yesteryear.

"We all pretend it's the Victorian era for the morning and try to project that whole image," said Purtell. "It's a like back in time for them where they can learn about Northville and what it was like in the Victorian era."

PENDLETON
GOOD FOR LIFE

NORTHVILLE PENDLETON
117 North Center St.
Downtown Northville

248-596-9820
toll free 866-868-9053

SELL YOUR HOME FAST & FOR THE HIGHEST \$\$\$ - GUARANTEED!*
Call 1-800-557-7271 Ext. 4030 for a FREE report.

BOB ALLWINE & BEV GILBERT
OVER 30 YEARS OF COMBINED EXPERIENCE!
www.HomeResults4You.com

RE/MAX 100 (248) 348-3300
422 N. Center - Northville, MI 48167

*Certain conditions apply. Each office independently owned & operated.

DISCOVER BONFIRE
39550 7 Mile Road (At Haggerty) • Northville • (248) 735-4570

BONFIRE

- Steaks, game, wood-fired pizzas, pastas, fresh fish, sandwiches and salads
- Casual-upscale, family friendly
- Handcrafted English-style ales and European lagers
- NEW extensive wine list

www.michiganmenu.com

Serenity Day Spa

Featuring the Vichy Shower

Full Body Massage • Body Wraps • Full Body Waxing
Manual Microdermabrasion • Personalized Facials
Make Up • Skin Care Products
Whirlpool Pedicure • Manicures
French Acrylic Nails • French Acrylic Toe Nails
Spa Packages • Day Spa Specials • Gift Certificates

248/465-1470
Located in Downtown Northville at 142 Main Centre

VICTORIAN ERA STRANGE-BUT-TRUE TRIVIA

- King George III was not well-liked when he ascended the throne but became more and more popular as he grew increasingly insane.
- The first programmable calculator (computer) was invented in 1833 in England by Charles Babbage.
- John Rushkin, in order to paint a snowstorm at sea, was actually tied to a ship's mast while at sea during the snowstorm.
- During the French Revolution, Madame Tussaud attended beheadings to make masks of the severed heads. She then used these to make her famous wax figures.
- When the Potato Famine in Ireland struck in 1845, fully 6 million people in Britain and Ireland existed almost completely on potatoes.



act sponsored by Community Federal Credit Union
The three-member Boogie Woogie Babies does an early 1900s swing music and dance revue.



Music, magic puppets and storytelling come alive when the Dream Machine Family Concert, comprised of Roland and Carol Ann Owens, takes stage

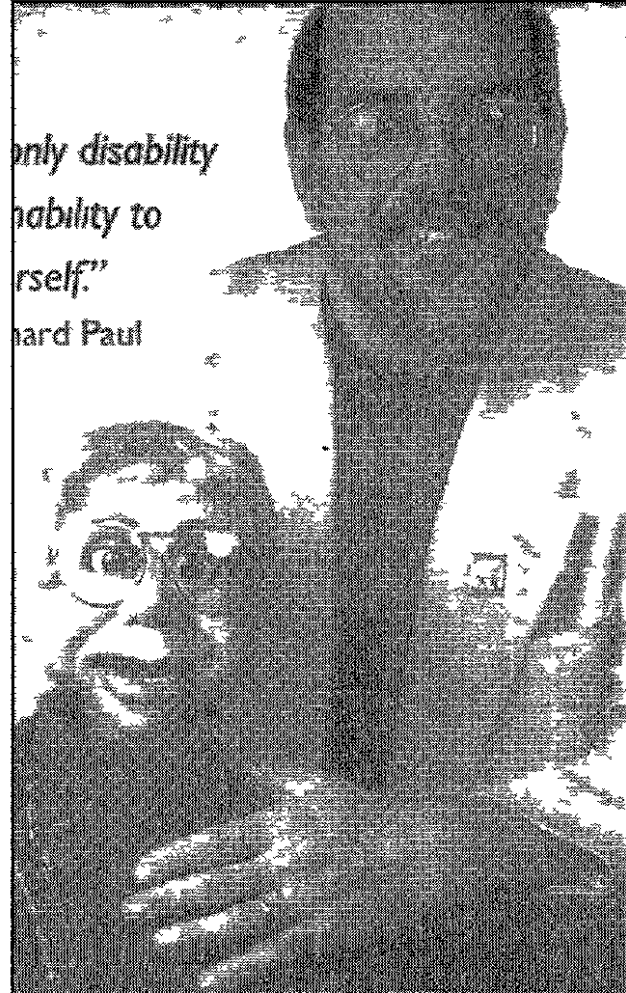

act sponsored by Water Wheel Health Club
Ventriloquist Richard Paul prints puppets and comedy to his all-ages performance

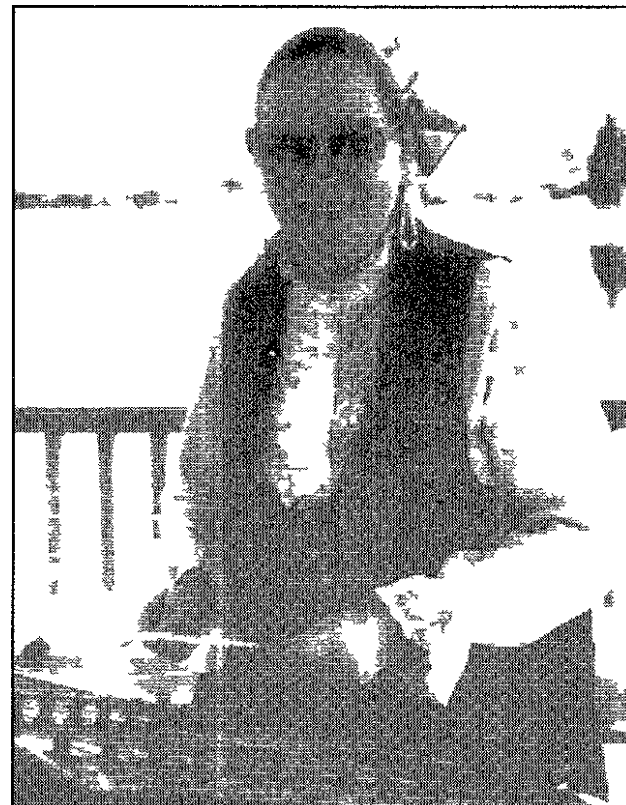

act sponsored by State Rep. Bruce Patterson (R Canton)
Charlene Berry uses two small hammers to play her portable dulcimer at the Victorian Festival



act sponsored by Marqu Theater (Northville)
Storyteller Mary Ellen Clark will tell stories to festival-goers using puppets and participants



act sponsored by Nuyen Tomtishen & Aoun PC
Clubs, torches and knives are just some of the objects used by juggler / unicyclist Ken Krakat. He's been known to use a bowling ball, too

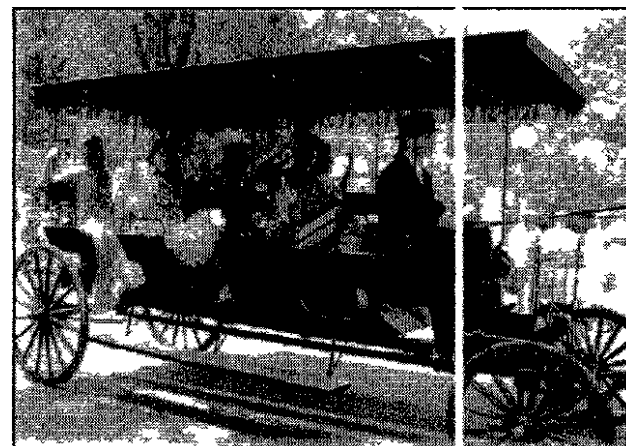

sponsored by McDonald Ford First Financial Mortgage Corporation, St. John's Golf & Conference Center and Singh Development
Free horse and carriage rides will be available for the afternoon and evening hours of the Victorian Festival

Artists flock to market

By **LON HUHMAN**
 Staff Writer

The eye candy will be plentiful during the Victorian Festival especially in the Art Market. The Art Market is held annually and is a juried fine arts show sponsored by the Northville Arts Commission. Arts commission member Sue Taylor said this year's festival will mark the 15 year anniversary of the Art Market which has become a Northville tradition. Taylor said the market gives festival goers the opportunity to experience contemporary art and converse with the artists directly.

Art Market will bring many fine artists onto Main Street in downtown Northville for festival goers who wish to browse and buy one of a kind artwork. Taylor said the festival is set to take place on Sept. 15 and 16. The art show and sale will be held from 10 a.m. until 8 p.m. on Saturday and 11 a.m. to 5 p.m. on Sunday. Taylor said there will be a wonderful selection of fine art ranging from stunning photography, Victorian stained glass, furniture and fiber art. In addition the market will also offer metal and clay sculptures, jewelry in metal, leather, gold and silver, as well as paintings in acrylic, oil and watercolor.

Though many artists come from around the Midwest, Taylor said Art Market also features the work of several Northville artists who enjoy exhibiting in their own hometown and perhaps meeting new neighbors.

According to Taylor, artists that call Northville home include Ken Barnes, Darcel Deneau, Rick Denomme, Gail Thomas and Katherine Wickersham. Barnes is an award winning potter trained in England and Deneau is an oil painter. Taylor said Deneau's previous show was a sell out. Thomas will display paintings that combine local

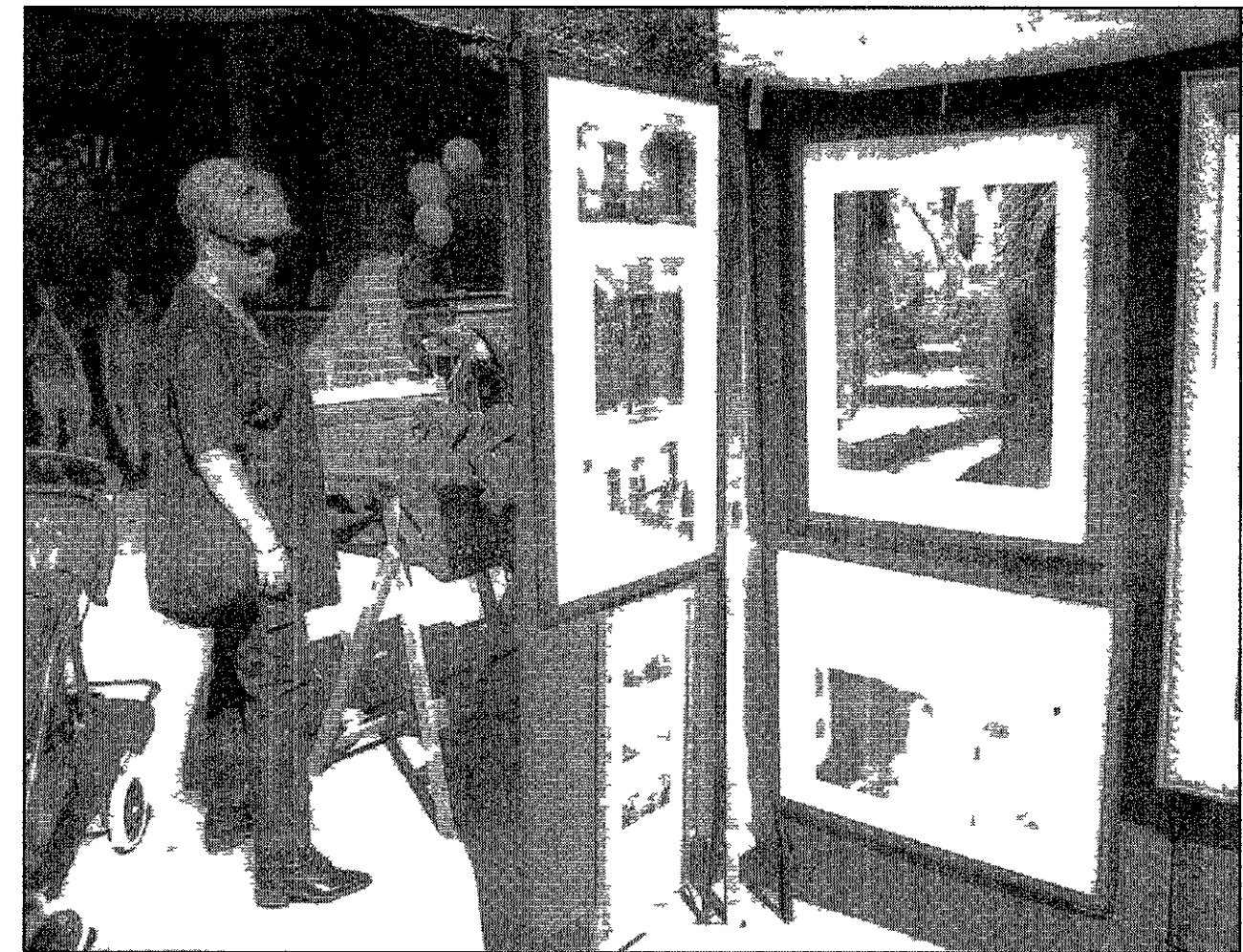

Photo by JOHN HEIDER

Victorian Fest-goers have a lot of art to choose from along the Main Street market architecture and gardens. Wickersham is a popular fiber artist and will be showing her extensive line of handmade clothing. Other featured art includes silk florals and watercolors by Annette Heyza, art pieces made of wood by Michael Miller and printmaking by Gayle and Ira Austin.

Lon Huhman is a staff writer for the Northville Record. He can be reached at (248) 349 1700 ext. 109 or by e-mail at lhuhman@ht.homecomm.net

ART MARKET PARTICIPANTS

Jeanne Anthony
 Elan Smador Livne
 Mary Ortwine
Katherine Wickersham*
 Wendy Lewis
 Migi Cherif
 Wendy Lewis
 John Crahen
 Debra VanTol
 Gail Fuehrer
 Beth Southwell
 Marilyn Joy
 Toni Kallas
 Antoni Kozlowski
 Alex and Gail Marks
 Jim and Cindy Pierson
 Ivy Solomon
 Bob and Sharon Spry

Fiber
 Fiber
 Fiber
Fiber
 Furniture
 Furniture
 Furniture
 Glass
 Glass
 Glass
 Glass
 Glass
 Jewelry
 Jewelry
 Jewelry
 Jewelry
 Jewelry
 Jewelry

David and Karen Turner
 Carol Whearty
 Kim and Frank Yanke
 Gary and Carol Ziegler
 Sergio Barceña
Darcel Deneau*
 Marie-Helene Grabman
 Mary Taros
 Brian McKelvey
 Cathy Dyer
 Boyd Creech
Rick Denomme*
 Luciano Duse
 John Galbo
 Darren Plante
 Laurel Spingola
Ken and Linda Barnes*
 Monica DeCampo
 Denise Kleiner

Jewelry
 Jewelry
 Jewelry
 Jewelry
 Jewelry
Oil Painting
 Paper
 Paper
 Pen and Ink
 Pencil
 Photography
Photography
 Photography
 Photography
 Photography
 Photography
 Pottery
 Pottery
 Pottery

Richard Salay
 Kathleen Sandberg
 Miles Stearn
 Jan Sadowski
 Gayle and Ira Austin
 Thomas Donall
 Annette Heyza

Tom Boyer
 Jana Conger
 Mane Lamothe
 Susanne Lawrence
 Martha Miller
Gail Thomas
 Michael Miller

* Northville-area participant

Pottery
 Pottery
 Pottery
 Pottery
 Printmaking
 Sculpture
 Silk Florals,
 Watercolor
 Watercolor
 Watercolor
 Watercolor
 Watercolor
 Watercolor
 Watercolor
 Wood

Box lunch auction goes far beyond food

By **CHRIS C. DAVIS**
 Editor

Buy a box lunch at the Victorian festival and you may walk away with gift certificates for frozen yogurt or University of Michigan football tickets. (You may even get a lunch, too.)

The box lunch auction has grown in popularity as Northville's Victorian Festival has evolved and according to auction coordinator Linda Maxfield this year's auction should be no exception.

The more people that come out to this the more fun it usually is," Maxfield said. "Originally the idea was for people to come out and buy a lunch they could take and eat at Mill Race Village, but in the last few years the auction has gotten pretty extravagant.

What makes the box lunch auction unique are the borrowed themes used for many of the lunches. Maxfield said. Donations from businesses and organizations have included prizes of all varieties. Those placing bids on the lunches are almost always able to find a basket containing some item that interests the buyer.

One of the baskets that attracted a slew of attention from the younger set at last year's Victorian Festival was one devoted to the vocal band N Sync. That one definitely got a lot of looks and bids, Maxfield said.

Buyers come in plenty for the auction and many come ready to spend. Maxfield said. Last year's most expensive box lunch sold for around \$500, she said.

Proceeds from the sale of the lunches go towards

the Northville co-council of PTAs, which often uses the money to cover parent education seminars. Some \$5,000 was raised last year, which helped bring in noted parenting lecturer Jim Fay.

We get a sea of businesses donating lunches for the auction, but we also encourage all the schools and the PTA to create a lunch," Maxfield said.

About 60 lunches will be available for purchase at the auction, and although a good number of the boxes contain gift certificates to restaurants, Maxfield said, organizers of the auction were pushing to have food included in the box lunches.

The box lunch auction begins at 11 a.m. Sept. 16 at the Northville bandshell.

Chris C. Davis is the editor of the Northville Record. He can be reached at (248) 349 1700 ext. 114 or at cdavis@ht.homecomm.net

Enjoy a stroll through Victorian history

By SAM EGGLESTON
Sports Reporter

What a gorgeous way to enjoy a view of the historical Victorian style housing of Northville while getting fit and admiring the beginning of the fall colors all packaged in a tidy three mile walk sponsored by the Northville Parks and Recreation and the Running Fit store. In its seventh year as part of the Victorian Festival the Victorian Festival Fitness Walk is a great way for participants to enjoy their morning fitness while viewing the beautiful Victorian architecture of the Northville community.

The people who participate in the fitness walk will walk past a number of historic homes as they walk through the neighborhoods of Northville parks and recreation special events planner Sue Taylor said. "The walk will take place when the leaves are just beginning to change color. It should be very pretty."

The walk which is scheduled for Sept. 15 beginning at 8:30 a.m. will begin and end in front of the Northville Senior Center located at 215 West Cady Street in Northville.

A cost of \$10 will be charged to pre-register for the walk with proceeds going to benefit Northville park improvement projects and those looking to register for the walk can pick up a form at Parks and Recreation Running Fit stores or at the Northville Chamber of Commerce Registration on the day of the event will be from 7:45 to 8:15 a.m. and will be \$12.

We are planning on having some refreshments for the participants and a small giveaway as well," Taylor said. "The rest (of the proceeds) will benefit the projects to improve Northville Parks."

Not only will people participate in the three mile walk benefit the park improvement projects with the registration fee they will also benefit their health with the walk in the clean air of Northville and see the beauty that the architecture style has to offer.

"It is an enjoyable way to spend a morning walking along the neighborhoods that have the historic homes and the beautiful large trees that will be changing colors," Taylor said.

According to Taylor the walk usually draws anywhere from 150 to 200 participants. Similar numbers are expected this year as well.

"I think it will (draw about the same number)," Taylor said. "It draws the participation because of the history of it and people look forward to it. Northville is a beautiful town to walk around."

For those looking to join in the enjoyment of the Victorian Festival the walk is a good place to start.

They can join the Victorian Festival right after Taylor said. "When they finish with their walk the festivities will be just beginning and it will just be a short walk to downtown."

For more information about the Victorian Festival Fitness Walk call Northville Parks and Recreation at (248) 349-0203.



Photo by XXXXXX

Entire families dress in the era's garb for the Northville Victorian Festival parade which kicks off the weekend celebration.



Magician Chris Linn will be dazzling audiences with his slight-of-hand and fun illusions.

VICTORIAN FESTIVAL ENTERTAINMENT



act sponsored by Comcast

The Great American Street Organ Jubilee is a hand-crank organ that provides the sounds of the circus and carousel, but also provides music, comedy, magic, fire-eating and balloon sculptures.



act sponsored by Main Street Family Chiropractic Center

Chris Clark's show includes a variety of magic tricks, juggling and comedy.

SCHEDULE OF EVENTS

FRIDAY, SEPT. 14		
TIME	EVENT	LOCATION
6 p.m.	Great Lakes Railroad	various locations
6 p.m. - 9 p.m.	Joel Tacey juggler / magician	various locations
6:30 p.m.	Victorian Parade	various locations
Until 9 p.m.	Horse & carriage rides	Wing / Main
7:30 p.m.	Clarks Punch & Judy Show	various locations
7:30 p.m.	Chris Clark juggler	Main / Center
7:30 p.m.	Chris Linn magician	Center / Dunlap
8 p.m.	Greg Lester	Main / Center
8 p.m.	Puppet Adventures	Main / Center
8 p.m.	Great American	Center Street
8 p.m. - 10 p.m.	Street Organ Jubilee	Main Street
8 p.m.	Contra Dance	Main Street
SATURDAY, SEPT 15.		
TIME	EVENT	LOCATION
10 a.m. - 8 p.m.	Art market	
Noon	Great American	Center Street
Noon	Street Organ Jubilee	Center Street
Noon - 5 p.m.	Horse & carriage rides	Wing / Main
Noon - 5 p.m.	Steve Ziemann balloonist	various locations
Noon - 6 p.m.	Ken Krakat unicyclist	various locations
11 a.m.	Clarks Punch & Judy Show	various locations
11 a.m.	Greg Lester	Main / Center
11:30 a.m.	Puppet Adventures	Main / Center
11 a.m. - 6 p.m.	Chris Clark juggler	Main / Center
11 a.m. - 8 p.m.	Dulcimer	various locations
12:30 p.m.	Great Lakes Railroad	various locations
12:30 p.m.	Greg Lester	Main / Center
12:30 p.m.	Puppet Adventures	Main / Center
12:30 p.m.	Twin Masks	Center / Dunlap
1 p.m.	Chautauque Express	Main / Center
1 p.m. - 3 p.m.	Krispie Krackers	various locations
1 p.m. - 4 p.m.	Dixieland Band	various locations
1 p.m. - 4 p.m.	Renaissance Chorus	various locations
1:15 p.m.	Mary Ellen Clark storyteller	Center / Dunlap
1:30 p.m.	Motor City Brass Band	Bandshell
1:45 p.m.	Chris Clark juggler	Main / Center
2 p.m.	Great American	Center Street
2 p.m.	Street Organ Jubilee	Center Street
2 p.m.	Twin Masks	various locations
2 p.m. - 5 p.m.	Mary Ellen Clark storyteller	various locations
2:30 p.m.	Boogie Woogie Babies	Main / Center
2:30 p.m.	Dream Machine	Center / Dunlap
2:30 p.m.	The Spoon Man	Center / Dunlap
2:30 p.m.	Chautauque Express	Main / Center
3:00 p.m.	Chris Linn magician	Center / Dunlap
3:30 p.m.	Straw Hat Band	Bandshell
4 p.m.	Great American	Center Street
4 p.m.	Street Organ Jubilee	Center Street
4 p.m.	Greg Lester	Main / Center
4 p.m.	Puppet Adventures	Main / Center
4 p.m. - 8 p.m.	Joel Tacey juggler / magician	various locations
4:30 p.m.	Richard Paul ventriloquist	Main / Center
5 p.m.	The Spoon Man	Center / Dunlap
5 p.m.	Boogie Woogie Babies	Main / Center
6 p.m.	Great American	Center Street
6 p.m.	Street Organ Jubilee	Center Street
6 p.m.	Chris Linn magician	Center / Dunlap
6 p.m.	Richard Paul ventriloquist	Main / Center
7:30 p.m.	Chris Linn magician	Center / Dunlap
7:30 p.m.	Richard Paul ventriloquist	Main / Center
SUNDAY, SEPT. 16		
TIME	EVENT	LOCATION
11 a.m.	Clarks Punch & Judy Show	various locations
11 a.m.	Chautauque Express	Main / Center
11 a.m.	Twin Masks	Center / Dunlap
11 a.m. - 5 p.m.	Great Lakes Railroad	various locations
11 a.m. - 5 p.m.	Art market	various locations
11 a.m. - 5 p.m.	Dulcimer	various locations
11:30 a.m.	Great American	various locations
11:30 a.m.	Street Organ Jubilee	Center Street
11:30 a.m.	Chris Clark juggler	Main / Center
11:30 a.m.	Richard Paul ventriloquist	Main / Center
12:50 p.m.	Chris Linn magician	Center / Dunlap
Noon	Greg Lester	Center / Dunlap
Noon	Puppet Adventures	Main / Center
Noon	The Spoon Man	Center / Dunlap
Noon	Dream Machine	Center Street
Noon - 5 p.m.	Horse & carriage rides	Wing / Main
Noon - 5 p.m.	Steve Ziemann balloonist	various locations
Noon - 5 p.m.	Great American	various locations
1 p.m.	Street Organ Jubilee	Center Street
1 p.m.	Krispie Krackers	Center Street
1 p.m.	Dixieland Band	various locations
1 p.m.	Renaissance Chorus	various locations
1 p.m.	Mary Ellen Clark storyteller	various locations
1 p.m.	Joel Tacey juggler / magician	various locations
1 p.m. - 5 p.m.	Ken Krakat unicyclist	various locations
1:30 p.m.	Twin Masks	Center / Dunlap
1:30 p.m. - 3 p.m.	Motor City Brass Band	Bandshell
1:45 p.m.	Chris Clark juggler	Main / Center
2 p.m.	Richard Paul ventriloquist	Main / Center
2 p.m.	Dream Machine	Center / Dunlap
2:30 p.m.	Great American	Center / Dunlap
2:30 p.m.	Street Organ Jubilee	Center Street
2:30 p.m.	Chris Linn magician	Center / Dunlap
2:30 p.m.	Boogie Woogie Babies	Main / Center
3 p.m.	Greg Lester	Main / Center
3 p.m.	Puppet Adventures	Main / Center
3 p.m.	The Spoon Man	Center / Dunlap
3:30 p.m.	Richard Paul ventriloquist	Center / Dunlap
3:30 p.m.	Boogie Woogie Babies	Main / Center
3:30 p.m. - 5 p.m.	Straw Hat Band	Bandshell
4 p.m.	Great American	Center Street
4 p.m.	Street Organ Jubilee	Center Street
4 p.m.	Chris Clark juggler	Main / Center
4:30 p.m.	Chris Linn magician	Center / Dunlap
4:45 p.m.	Richard Paul ventriloquist	Main / Center



act sponsored by Onn Jewelers

The Amazing Clark has developed his own version of the Punch & Judy Puppet street show, which encourages audience interaction. This is his eighth year performing at the Victorian Festival.

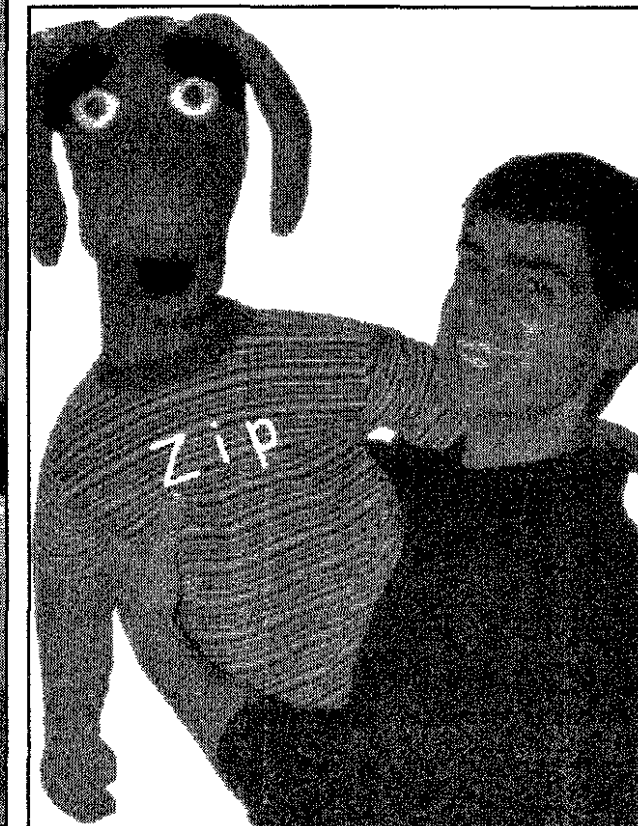

act sponsored by Bonnie Brook Development LLC

Greg Lester's Puppet Adventures puts a new spin on "Jack and the Beanstalk" with animation, special effects and lighting — a hit with younger audiences.



act sponsored by TDS Metrocam

Guy Louis and his Chautauque provides a musical program for all ages. Specializing in stringed instruments, Louis plays both the guitar and the mandolin, and frequently looks for audience assistance for the performance of certain songs.

REMEMBER, ONLY YOU CAN PREVENT FOREST FIRES.

A Public Service of the USDA Forest Service and Your State Forester.



act sponsored by St. Mary Mercy Hospital
The Spoon Man has delighted crowds with his use of dinnerware to kick up a great beat.



act sponsored by Edward's Caterer / Helen's Uptown Cafe
The Motor City Brass Band represents the tradition of British brass bands. The group is directed by Craig Strain and plays jazz, pop, rock and classical.



sponsored by Davis Auto Care / Jim's Oil Depot / Ultimate Imagine Auto Spa
The Great Lakes trackless train will provide free transportation to and from parking lots around the Victoria Festival. Look for it in Frida / night's parade, too.

Dressing Victorian doesn't have to be hard

By **KELLI COOLEY**
 Editor

Besides decisions on what to eat and do at the Victorian Festival the most important decision happens weeks before what to wear.

Although dressing in costume is not required at the festival many residents and area visitors see it as a chance to turn back the clock and don apparel now virtually extinct.

Men in the Victorian era wore sack style suits with collars, white shirts and colorful ties. The ties could be ascots, four in hand or bow style. Pants were usually straight legged and without cuffs. Accessories included suspenders, bowler hats or straw boater hat in the summer. Pocket watches with chains were popular as well but not in the style worn in the zoot suit era. Watch chains were worn across a vest.

Boys wore knickers, those fun pants that bloomed before tapering at the knee, pleated shirts with round collars and string or scarf ties. In the summer overalls were worn without a shirt.

Girls wore short dresses, no not a mini, these were below the knee as

VICTORIANWEAR.COM?

VICTORIAN OUTFIT PATTERNS

www.mccall.com - limited styles for women pattern number 3292

www.agelesspatterns.com - various patterns for men, women, girls, boys infants and even accessories

www.pastpatterns.com - women's styles

www.longago.com/victorian.html - men's and women's outfit patterns

www.cinderellasattic.com - Victorian clothing and accessories

well as long stockings and large bows in their hair. Sunbonnets were worn by little girls. Dresses were a line style or a gathered skirt with a pinafore or apron covering it.

Women's styles varied depending on the season and type of activity. Skirts were long, sometimes with fullness at the back. The bodice or blouse was smooth fitting and could be either tail-

ored and pleated or lacy and highly ornamented. Daytime necklines were high, decorated with a brooch and waistline were emphasized. Sleeves were long and leg o mutton style. Accessories included shawls, aprons, large brimmed hats and black jewelry.

These types of outfits can be hard to find in the 21st century and they can be expensive to boot. JoAnn Etc. s

offered classes on making a Victorian child's skirt and pinafore as well as ladies Victorian skirt and hat this year all for \$15 or \$20 dollars. There are also ways to purchase patterns to sew the lovely dresses and handsome suits for the one you love.

There is also a Victorian Festival clothing sale at the Mill Race Village Church from 1-4 p.m. on Sept. 9.

Many stores in the area have also found a market in Northville to sell Victorian clothing.

Apple Annie's in Ypsilanti, House of Costumes in Plymouth, Knightsbridge Antique Mall and Marquis in Northville and Sutton's Costumes in Waterford allow the costume seeker to purchase or rent clothing for the festival week end.

The biggest draw to dressing up is transforming into a different person from a different time period. It's also the best excuse to wear ball gowns and dapper suits.

Kelli Cooley is the editor of the *Novi News/Lake Area Times*. She can be reached at (248) 349-1700 ext. 113 or at kcooley@ht.homecomm.net.

Introducing SALEM TOWNSHIP'S NEWEST RESIDENTIAL DEVELOPMENTS

LAPHAM LAKE ESTATES

15 HOMES ON 36 ACRES

SURROUNDED BY OPEN LAND, LANDSCAPE & WATER

Developed By: **Marcello Scappaticci** 734-416-9118
 Developing & Building since 1951

Custom Homes By: **Bonnie Brook Homes, LLC**
 (248) 380-3060

(734) 453-8720

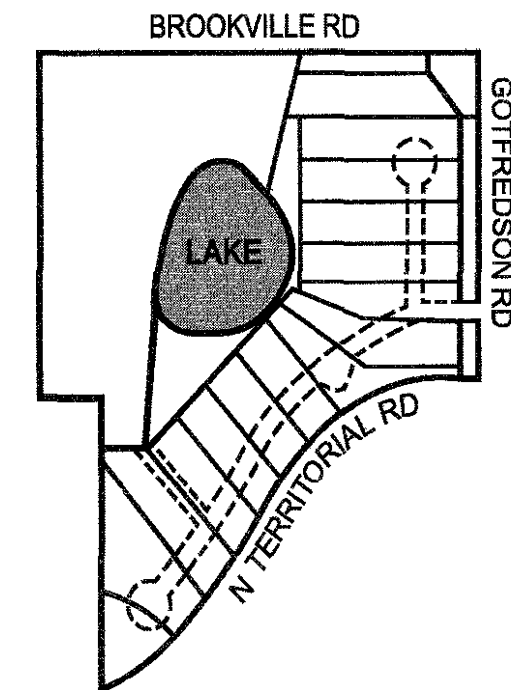

Community Features

- 2 1/2 acre homesites
- Professionally landscaped
- Community parks and open space
- Central lake for fishing and swimming
- Strict architectural controls provide protection for your investment
- Street lighting
- Underground utilities

Area Attractions

- Highly acclaimed Plymouth-Canton Schools
- Easy access to M-14 at Gotfredson Road, heading to Ann Arbor or Detroit
- 20 minutes to Ann Arbor
- 25 minutes to Detroit Metropolitan Airport
- A short drive to historic downtown Plymouth and Northville shopping districts
- Convenient to area golf courses, including Fox Hills Country Club
- Many denominational churches nearby
- Close to major hospitals and medical centers
- 5 minutes to Compuware Sports Arena

A Place of Grandeur

