

Vacationers offered happy trails trips, 5B



All-Star affair, 1C

How writer missed out on Pulitzer, 10A

# Plymouth Observer

Volume 100 Number 80

Monday, June 23, 1986

Plymouth, Michigan

40 Pages

Twenty-five cents

1986 Suburban Communications Corporation All Rights Reserved.

## plymouth pipeline

**GRADES COMING:** High school students may pick up their report cards between 8 a.m. and 2 p.m. Monday, June 30. Plymouth Canton High students may pick up their report cards in the Canton general office and Plymouth Salem High students in the Salem general office. Seniors can expect to find a book deposit refund check attached to their report cards if they do not have any unpaid debts.

### VISITING THE LADY:

Chad Peterson, age 8 of Plymouth, has been invited by General Foods to the special July 4th celebration in New York City to visit the refurbished Statue of Liberty. Chad, son of Mr. and Mrs. Chris Petersen of Plymouth Township, will be on a barge in the New York harbor — on the New Jersey side — to view the celebration. The barge will carry a stage which will feature country music entertainers. Chad has taken a special interest in the Statue of Liberty for the past two years.

### STREET DANCING:

The Plymouth Community Chamber of Commerce announces the beginning of its street dances for this summer. The first featured Tony Russo this past Friday in the central business district. Bands performing at the free dances from 7:30-9:30 p.m. Fridays through Aug. 29 include: Jim Joseph, June 27; Dan Vience, July 11; Eric Rossenaw, July 18; Frank Vience, July 25; Phil Graham, Aug. 1; Joe Dunlap, Aug. 8; Bob DuRant, Aug. 15; Ron Jackson, Aug. 22.

**FULL WEEKEND:** The Plymouth Fife and Drum Corps, always in demand, was busier than usual last weekend. Friday, the colonial-garbed musicians were scheduled to perform at a reception associated with the Grand Prix in Detroit, Saturday at the Sugar Festival Parade in Sebewaing and Sunday at the Bay Rama Fish Fry in New Baltimore.

Now that's a lot of tooting and tapping.

Please turn to Page 4

## what's inside

Brevities . . . . . 8B  
Cable TV . . . . . 2A  
Campus News . . . . . 2A, 7B  
Clubs In Action . . . . . 5B  
Medical Briefs . . . . . 7B  
Obituaries . . . . . 2A  
Opinion . . . . . 10A  
Readers Write . . . . . 10A  
Shopping Cart . . . . . 1B  
Suburban Life . . . . . 5-6B

NEWSLINE . . . 489-2700  
SPORTSLINE . . 591-2312  
WANT ADS . . . 591-0900  
HOME DELIVERY 591-0600

**CREATIVE LIVING** REAL ESTATE GUIDE  
You discover the best  
IN EVERY THURSDAY EDITION

## Financing found for fireworks

By Doug Funke  
staff writer

Yes. No. Maybe. And finally, yes. The Fourth of July fireworks in Township Park are definitely on.

The annual event, coordinated by the Plymouth Jaycees has been saved by 11th-hour contributions from several auto dealers and a brewery.

"We're going to have the best fireworks show we've ever had out here," said Charles Lowe Jr., coordinator of the display for the Jaycees. "The Plymouth-area car dealers get the headline. They have come through. They're backing the show."

Sunshine Honda, Don Massey Cadillac, Fox Hills Chrysler Plymouth and Dick Scott Dodge and Buick dealerships have committed, Lowe said.

Also, the Adolph Coors Co., which previously indicated it wouldn't participate, has changed its mind, he added.

"THEY CAME in at the last minute. It was a shock to us," Lowe said. "It wasn't in the budget for them. They came up with money at the last minute. It shows how interested they are in supporting the community."

The dealers will exhibit cars in the park in return for their sponsorship, Lowe said.

An expanded fireworks show featuring the Plymouth Symphony Orchestra was announced with much fanfare earlier this spring. Some mi-



file photo

Fireworks will fill the skies of Plymouth on July 4 after all.

nor glitches developed over liability insurance and the availability of the orchestra. Then major money problems surfaced.

A last-gasp fund-raising effort finally met success.

"I approached some car dealers a couple of months ago but the idea didn't sell," Lowe said. "But that was a business decision. When we reached the point where we didn't have a show anymore, they came to our rescue."

Other sponsors identified by Lowe are McDonalds, K mart and Plymouth Construction Co.

The symphony could have been left in a lurch — or at least with a

difficult decision — if the fireworks had been cancelled.

THE ORCHESTRA agreed to perform July 4 in conjunction with the fireworks in lieu of a concert next April.

Leon Gregorian, the symphony's new conductor and music director, is to make his local debut at the Independence Day concert.

K.C. Mueller, immediate past president of the symphony, said she was hesitant to go ahead without the fireworks primarily due to concerns about the size of the crowd.

"I'm really grateful to the car dealers, I really am," Mueller said. "I really didn't want to go out there without the fireworks. Everything is in order as it should be. It's a community effort and I'm really pleased."

Mueller said Plymouth-Canton Community Schools, Plymouth Township, Air Tite Insulation, the Plymouth Community Arts Council and the Woman's Club of Plymouth have been instrumental in assisting the symphony prepare for the Fourth of July concert.

"Now, everything has fallen into place again," Lowe said. "This is a great opportunity. We have a live orchestra in a terrific setting. We're all set to go. It's going to be a terrific show."

"Now is the time for the Jaycees to go to work. We've got a lot of details to iron out in the last two weeks."

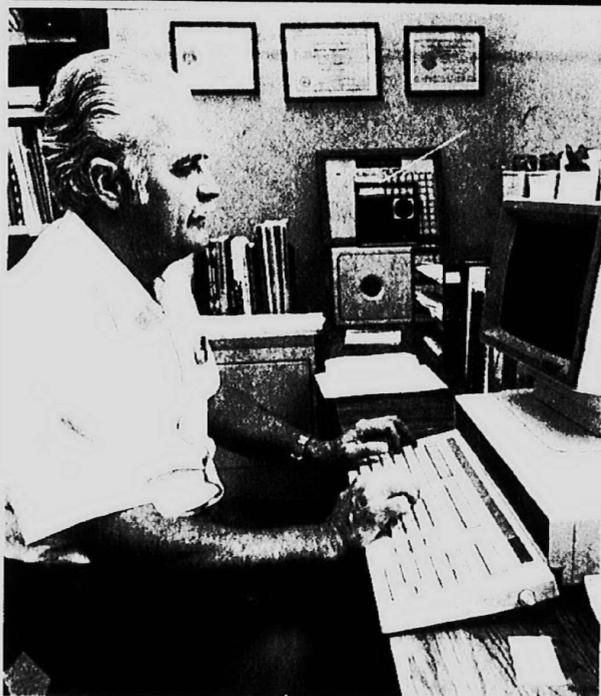

BILL BRESLER/staff photographer

Plymouth police use a computer to keep track of contacts with trespassers and loiterers in the business district. Mike Richardson, administrative assistant, has all kinds of information available at his fingertips.

## Youth control Police hope to curb loitering

By Doug Funke  
staff writer

Plymouth's summer Main Street Program, designed to discourage young people from trespassing and loitering in the central business district, has succeeded so far based on at least one measurement, police say.

Between May 31 and June 19, officers issued written warnings to 105 young people for hanging out on private property after business hours. Only one has been ticketed as a repeat offender.

"The flaw is they might be going to businesses that aren't participating" in the program, said Police Chief Richard Myers.

The Main Street Program was started last year and fine-tuned this spring by the city attorney, city police and judges in the 35th District Court.

Businesses were required to post no trespassing and no loitering signs on the premises and agree to prosecute violators.

POLICE ISSUE warnings on first

contacts and give violators a list of the more than 30 businesses that have agreed to crack down. Police also enter the names of first time violators into a computer for future reference.

District court judges have indicated they will sentence persons subsequently ticketed and found guilty to two days of community service work and fines totaling \$90, the chief said.

Myers has no delusions that the Main Street Program has totally eradicated a problem. He suspects that 25-30 violators go free for every warning issued.

Only a few police officers are on duty at any given time, Myers said. They have other responsibilities.

From 3 p.m. Friday, June 13 through 7 a.m. Monday, June 16, police were dispatched on 65 runs and still managed to issue 25 trespassing warnings.

Cruisers, persons who drive up and down Main with no specific destination, compound the trespassing problem, Myers said. "We get 200-300 carloads per night. It's a lot when it's little, old Plymouth. They're leaning out windows, hoot-

ing and hollering, yelling out windows. It's boys and girls."

"They feed off each other. Trespassers go there to hang out and that's what brings the cruisers."

MYERS, sympathetic to both kids and other segments of the community, said he sometimes gets frustrated because officers are expected to wear many hats on the job.

"Why can't we find a place for them to gather without getting the police involved?" he said. "I'll tell you whose job everybody thinks it is to do that — the police department. Parents is where it's got to start."

"I have two answers. Number one, somebody ought to figure out something for these kids to do, somewhere to go without bothering anybody," Myers said.

"Number two, all of the adults who are fearful and intimidated, get together, walk downtown, get an ice cream and see that the kids are harmless."

Of the first 105 trespassing warnings issued by police, 34 went to Can-

Please turn to Page 4

## State holds hearing here on home study

By Kevin Brown  
staff writer

While an increasing number of parents are choosing to educate their children in the home rather than trust that task to the public schools, there are no state laws setting guidelines for home study.

A Michigan House of Representatives bill that would establish guidelines for home study was presented to about 150 interested parents and educators at a public hearing Friday at Plymouth Canton High School.

At the hearing, the first in a series to be presented this summer around the state, those supporting home study touted the benefits of teaching their children one on one, and of providing a Christian emphasis public schools do not provide.

But those against the house bill said it did not require a specified number of instruction hours or teacher certification, adding there are not sufficient checks on attendance and student progress in the proposed legislation.

BECAUSE THERE is no Michigan legislation governing home study, "There needs to be some degree of definition," said Rep. James Kosteva, D-Canton, a member of the Special Sub-Committee on Education, which presented the public hearing.

In its present form, the house bill allows a parent or guardian to teach children in a home study program if certain requirements are met. Under those guidelines, a parent can employ a tutor "who possesses a college degree or equivalent life experience." The program must provide at least 180 days of pupil instruction; pupils must take a standardized test during fourth, seventh and 10th grades; and yearly written progress reports must be made.

And while those seeking to operate such a program must notify the local school superintendent, reports or test results do not have to be submitted to the district for approval.

Speaking on behalf of the Michigan Public Association of School Administrators, Plymouth-Canton Su-

perintendent of Schools John M. Hoben said that while he did not oppose the concept of home school, he objected to the lack of controls: "I feel there is a great deal of educational quackery going on."

Hoben said that of nine home study programs in this school district, seven are "not legitimate," claiming "there is a tendency to eliminate rules and regulations."

Julie Kuhar of Canton, a former Catholic school teacher who is teaching her children at home, said home study "cannot be an option only for those who can afford to hire a tutor or have certification."

Responding to comments from those opposed to home study on grounds that sufficient educational materials are not provided, Kuhar said "the diversity of learning modes is enormous" — libraries, museums and readily available written materials.

SEVERAL PROPONENTS of

home study cited the Bible in making their case.

Eugene Newman, vice president of Christ United to Reclaim Education, quoted a biblical proverb: "The fear of the Lord is the beginning of knowledge."

By definition, he said, proper Christians are "opposed to an atheistic and secular perspective."

Arthur Allen of Temperance, who with his wife teaches their three children at home, told the legislators: "We take seriously that the Lord commands us to teach as parents. . . . Who has the opportunity to teach with that love at all times of the day?"

Allen said some noted past American leaders were taught at home, adding, "We don't want our children acting like part of the herd."

Pat Montgomery of Ann Arbor, who holds a doctor's degree and oversees several home study programs, said many of her students have gone on to college.

"There seems to be a pervasive el-

itism on the part of educators . . . toward parents' abilities to teach their own children." Parents, Montgomery claimed, are perceived by educators as "stupid people only able to bring cookies to PTA meetings and vote yes on a millage."

In opposition to the bill, Edith Gonzales, president of the Michigan Association of School Boards, asked, "What standards, if any, would be observed?"

While public schools tolerate different pupil backgrounds and religions, Gonzales claimed home study can foster "narrow, provincial attitudes in these children."

Nancy White of Plymouth, president of the League of Women Voters of Michigan, said the organization opposed the bill, adding the league supports teacher certification.

Rep. Lynn Owen, D-Maybee, committee chairman, said that following public hearings, the bill would be studied for possible revision and could be acted on later this year.

## neighbors on cable

**CHANNEL 8  
MONDAY (June 23)**

5 p.m. ... Tell Me A Story — Gina talks with kids about the Letter A and the Numeral 3.

5:30 p.m. ... Healthcize — A program about exercising your arms, legs, and other parts to get in shape.

6 p.m. ... Masters of Dance.

6:30 p.m. ... High School Sports — Plymouth Canton Chiefs vs. the Plymouth Salem Rocks in boys baseball.

9:30 p.m. ... Single Touch (live) — J.P. McCarthy takes calls and talks about upcoming events for singles in the area.

10 p.m. ... Videotunes (live) — Hosts Jimi Ray and Dr. Z with an hour of videotunes of local bands.

**TUESDAY (June 24)**

5 p.m. ... Cinematique — Hosts David Daniele and John Martin review classic films unearthed from Omni's vault of gold.

5:30 p.m. ... Economic Club of Detroit — Speaker is Clifton Garvin, chairman of Exxon Corp.

6:30 p.m. ... Vivian School of Dance.

7 p.m. ... Beyond the Moon — Host Mike Best discusses Leo and human colonies in space stations.

7:30 p.m. ... Strawberry Festival Parade — Belleville's annual parade.

8:30 p.m. ... Herman's Royal Stallion Show — Taped at Belleville Strawberry Festival.

**WEDNESDAY (June 25)**

(Programming today is the same as shown on Channel 8 on Monday.)

**CHANNEL 15  
MONDAY (June 23)**

Noon ... Total Fitness — Jackie Starr works with aerobics.

12:30 p.m. ... For Your Health —

Host Pat Sciberras talks with Althea Grant, director of a rape counselling center.

1 p.m. ... Cooking With Cas — Cas prepares blueberry pancakes.

1:30 p.m. ... Woods Forum.

2 p.m. ... Isbister Talent Show — Students show off their talents at this year's show.

3 p.m. ... Human Images — Students at Plymouth Centennial Educational Park discuss questions related to family life styles, growing up in today's society, peer pressures, drugs, growing up pains, sex, obedience, etc.

3:30 p.m. ... The Sandy Show — Host Sandy Preblich.

4 p.m. ... Jeffrey Bruce: About Face — Tips on hair care and makeup as a benefit for Plymouth Symphony League.

5 p.m. ... 1st Presbyterian Church of Northville Presents: A Celebration! — This week's sermon is entitled "Profiles In Motherhood."

6 p.m. ... MESC Job Show — A look at job opportunities.

6:30 p.m. ... Canton Kitchen Band Jamboree.

7 p.m. ... Legislative Floor Debate — Information about what's going on in Lansing as it relates to Plymouth and Canton. Host Maria Holmes with State Rep. Gerald Law, R-Plymouth.

7:30 p.m. ... Governor's Report — Host Howard Lancour talks with Michigan Business Ombudsman Dick Allen.

8 p.m. ... Watch Out, It's Tornado Time — A film on the dangers of twisters.

**TUESDAY (June 17)**

noon ... Hamtramck Rotary — Speaker is FBI Agent Kenneth Walton.

12:30 p.m. ... Psychic Sciences — Ellie discusses numerology with Fran McClelland.

1 p.m. ... St. Florian Close Up.

1:30 p.m. ... Canton Update — Canton Township Supervisor James Poole and Sandy Pre-

blich talk about what's happening in Canton.

2 p.m. ... Hamburg Orchestra — A visiting orchestra from Hamburg, Germany, plays for residents at Plymouth First Presbyterian Church.

3:30 p.m. ... Omnicon Game of Week — Canton Rodeo is filmed at Canton Country Festival Friday night.

5 p.m. ... Idle Chatter.

6 p.m. ... Free For All — Host Leon Hordynsky.

6:30 p.m. ... Art & You — Treamon Hicks discusses figurative painting with Gary Chaplan.

7 p.m. ... 15th District Forum.

7:30 p.m. ... Live Call-In.

8:30 p.m. ... Benny and the Jets — Rock and roll band performs.

9:30 p.m. ... Youth View — A feature which describes what the Christian rite of confirmation is all about.

**WEDNESDAY (June 18)**

Noon ... First Presbyterian Church of Northville Presents: A Celebration.

1 p.m. ... MESC Job Show.

1:30 p.m. ... Canton Kitchen Band

Jamboree.

2 p.m. ... Legislative Floor Debate.

2:30 p.m. ... Governor's Report.

3 p.m. ... Watch Out It's Tornado Time.

5 p.m. ... Total Fitness — Exercise with Jackie Starr.

5:30 p.m. ... For Your Health — Host Pat Sciberras.

6 p.m. ... Cooking With Cas.

6:30 p.m. ... Woods Forum.

7 p.m. ... Isbister Talent Show.

8 p.m. ... Human Images.

8:30 p.m. ... Sandy Show.

9 p.m. ... Jeffrey Bruce: About Face.

**CHANNEL 10  
CANTON TOWNSHIP  
FRIDAYS**

6-10:30 p.m. ... Canton Township Board meeting.

**SATURDAYS**

Noon to 4:30 p.m. ... Canton Township Board meeting.

**CHANNEL 11  
PLYMOUTH-CANTON  
SCHOOLS**

## campus news

### KEITH KECSKES

Keith Kecskes of Plymouth was named to the John Carroll University, University Heights, Ohio, dean's list for earning a 3.5 or better grade point average for the recent spring semester.

### EDWARD MYTYCH

Edward Mytych of Harding, Plymouth, recently graduated from the University of Detroit with a master's degree in business administration. He is manager of technical support for the Burroughs Corp.

### KAREN WILEY

Karen Wiley, daughter of Mr. and Mrs. Gilbert McGeheen of Fairground, Plymouth, recently earned a bachelor's degree from the University of Detroit.

### TODD LUTES

Todd Lutes of Plymouth was named to the dean's list of Texas Lutheran College, Seguin, Texas, for earning a 3.5 or better grade point average in the recently completed spring semester.

### PAMELA CALCATERRA

Pamela Calcatterra of Plymouth Road, Plymouth, was named to the dean's list at Siena Heights College, Adrian, for earning a 3.5 grade point average in the spring semester.

### RICHARD ROUTSON

Richard Routson of Arthur, Plymouth, recently earned distinguished student ranking at Purdue University, West Lafayette, Ind., for earning a grade index of 5.5 or better out of a possible 6.0.

### GRAND VALLEY HONOREES

Paul Cyburt and Margaret Wangbichler of Canton and Karla Davenport and Marion King of Plymouth were recently named to the Grand Valley State dean's list for earning a 3.5 or better grade point average in the recently completed winter semester.

### ANDERSON HONOREES

Valorie Andres of Ridge Road and Charles Slayton of New England Lane, both of Canton, were recently named to the dean's list at Anderson College, Anderson, Ind., for earning grade point averages of 3.5 or better.

### MICHAEL MAC

Michael Mac of Elm, Plymouth, recently earned a doctoral degree from the department of zoology and physiology at the University of Wyoming.

### STEVEN WEST

Steven M. West of Plymouth recently earned a bachelor's degree from Colorado College, Colorado Springs.

### JANE SHEPHARD

Jane Shephard of Drury Lane, Plymouth, recently earned a bachelor's degree from the University of North Carolina, Greensboro.

### MARK ZIELKE

Mark K. Zielke of Palmer, Plymouth, has earned a bachelor of science degree in building science from Rensselaer Polytechnic Institute in Troy, N.Y.

### JAMES STEFFEN

James R. Steffen, son of Bobbie Steffen of Admiralty in Canton, has earned a bachelor's degree at Princeton University. Steffen, who concentrated in the study of political economy, was awarded highest honors by the department of politics. He also was elected to membership in Phi Beta Kappa, the national honor society. He graduated first in his class from Plymouth Canton High School in 1982 and will enter the University of Michigan Law School in August.

### RONALD KING

Ronald King, son of Barbara and Les King of Shadywood Dr., Plymouth, has earned a bachelor's degree in public policy from the University of Chicago.

### SANDRA GOTTWALD

Sandra D. Gottwald, daughter of Danielle and Henry Gottwald of Betty Hill, Plymouth, has graduated with a medical degree from the University of Michigan Medical School. Dr. Gottwald was a University of Michigan Alumni Scholarship recipient in 1983 and 1984, earned medical school honors in biochemistry, introductory clinical sciences, microbiology, urology, child psychiatry, neonatal intensive care unit, and gynecologic oncology. She was a member of the six-year integrated premedical medical program, Inteflex, and is expected to begin residency in OB-GYN at University Hospital, Ann Arbor, this month.

From Canton: Ellen Kremer of Canton, a senior majoring in biological sciences; Linda G. Lipford of Canton, a sophomore in electrical engineering; Alan Mathews of Plymouth, a sophomore in geological engineering; Lisa Russell, a sophomore in premedicine; and Mark Yergin, a junior in mechanical engineering.

### TECH HONOREES

The following residents were on the dean's list for the spring term at Michigan Technological University, Houghton:

## obituaries

### JOHN DERR

Funeral services for Mr. Derr, 70, of Livonia were held in Lambert-Vermeulen Funeral Home in Plymouth with burial at Oakland Hills Cemetery, Novi. Officiating was the Rev. Robert Millar.

Mr. Derr, who died June 15, was born in Detroit. Survivors include: wife, Erika; sons, John of Plymouth, William of Plymouth, and Charles of South Bend, Ind.; brother, William of Bloomfield; and five grandchildren.

### OSCAR E. DOOLIN

Funeral services for Mr. Doolin, 73, of Canton were held recently in Schrader Funeral Home with burial at Knollwood Cemetery, Canton. Officiating was the Rev. Wandell Ferguson.

Mr. Doolin, who died June 13 in Ypsilanti, was born in Allen County, Ky., and moved to Canton in 1945.

*We Deliver.*

We're looking for carriers to deliver The Observer & Eccentric Newspapers. Interested? Call 591-0500 for route details

### CRIMINAL ASSAULT PREVENTION SEMINAR



"Every day thousands of murders, rapes, assaults, and attacks occur... YOU DON'T HAVE TO BE A VICTIM!"

### LEARN HOW TO REACT!

Hyatt Regency - DEARBORN • Novi Hilton - NOVI  
Troy Hilton - TROY • Presidential Inn - SOUTHGATE

CALL FOR FREE BROCHURE  
283-0585

## COMPLETE SKIN CARE

MICHAEL J. REDMOND M.D., P.C.

Announces  
The Opening of His Office For Treatment of  
Diseases of the Skin, Hair and Nails

### MEDICAL • SURGICAL • COSMETIC

- Acne, Rashes, Skin Irritations
- Warts, Moles, and Skin Growths
- Skin Cancer Detection & Treatment
- Collagen Implant Therapy
- Removal of Spider Leg Veins

FOR APPOINTMENT  
CALL 464-8400  
37672 Professional Center Drive  
(Located Near 6 Mile & Newburgh)  
LIVONIA

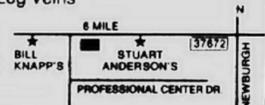

## Family Discount Drug

PACKAGE LIQUOR DEALER

**HÄLSA**

Our Price \$1.49  
Less Refund -1.50  
Your Profit .01

### HÄLSA \$1.50 CASH REFUND CERTIFICATE

To receive your \$1.50 refund, purchase any 4 oz. 12 oz. or 16 oz. HÄLSA and send in the following proof-of-purchase requirements:

1. Cash register receipt, dated between May 12, 1988 and August 31, 1988 with the purchase price of HÄLSA circled.
2. Copy of newspaper clipping or 10¢ or 15¢ coin (see diagram) OR send top half of the HÄLSA 4 oz. box with the words "HÄLSA" stamped on the bottom of it.
3. Send the related documents including your name and address (please print).
4. Mail the completed certificate with your cash register receipt and coin OR top half of HÄLSA box to:

NAME \_\_\_\_\_  
ADDRESS \_\_\_\_\_  
CITY \_\_\_\_\_ STATE \_\_\_\_\_ ZIP \_\_\_\_\_

Expires: Two \$1.50 refunds per person, family or address. Void where taxed or restricted by law. Requests must be postmarked on or before August 31, 1988. Allow 4-6 weeks to receive your check. This certificate must accompany all requests and may not be reproduced. Offer good only in the United States.

EXPIRATION DATE: August 31, 1988

© 1988 H.J. Anderson & Son, Inc., Detroit, MI



## MADE FOR ACTIVE FEET

**WOMEN'S COTTON ATHLETIC SOCKS WITH COOL, VENTILATED SOLES**

Let your feet breathe naturally with Sweet Soles™. Patented cotton socks with cushiony soft, ventilated soles. Perfect for sports or long distance walking because they keep feet fresh and comfortable all year long...warm in the winter, cool in the summer. Roll-down style in white; Turn-down in solid white or white with stripes; Pom-pon bootie in solid white or white with stripes. Fit sizes 9-11. Pair, 3.50; 3 for 9.25.

## Jacobson's

We welcome Jacobson's Charge Card or The American Express® Card.

Shop until 9 p.m. on Thursday and Friday  
Until 6 p.m. on Monday, Tuesday, Wednesday and Saturday

**STAN'S DISCOUNT BEVERAGE**  
38001 Ann Arbor Road

7-UP, DIET 7-UP, CITRUS 7, DIET CITRUS 7, ORANGE CRUSH, DIET ORANGE CRUSH, GRAPE CRUSH, PINEAPPLE CRUSH, STRAWBERRY CRUSH, CANADA DRY, BARREL HEAD ROOT BEER

8 PACK 16 OZ. \$1.89 + DEP.

COKE, CLASSIC COKE, DIET COKE, CHERRY COKE, DIET CAFFEINE FREE COKE, TAB, DR. PEPPER, SUNKIST, SPRITE, DIET SPRITE, SQUIRT, DIET SQUIRT

TWO 1.38 8 PK. 1/2 LITER LITERS + DEP. 2.29 + DEP.

Offer Good June 23-June 30, 1988.

**JOIN THE GOLD RUSH**

14 Kt. GOLD CHAINS \$16 A GRAM

Look For The Gold Rush Jeweler

O. & D. Bush Jeweler

401 Ann Arbor Trail • Plymouth 488-3030

1400 SHELTON ROAD  
ANN ARBOR, MI 48106-1500  
DISCOUNT PRESCRIPTIONS

# House rejects change in school days

By Tim Richard  
staff writer

Teachers' unions flexed their political muscle as the state House of Representatives beat down plans to require 180 days of classroom time a year.

The issue was whether to eliminate four specifically allowed snow days from the \$558 million school aid bill.

State aid is based on 180 days, but schools are not penalized for days lost due to boiler breakdowns, "snow days," teacher training and part-day parent-teacher conferences.

"The school year has been reduced 20 days in 20 years — from 192 days when I was on the local school board to 172," charged Rep. William Keith,

D-Garden City, author of one of the defeated amendments.

"Our youngsters have to compete (when they graduate) on a global level with those in foreign countries who have had 220 to 240 school days a year."

SCHOOL BOARD lobbyist Gerald Dunn, whose clients are 10 suburban districts, said the Michigan Education Association and American Federation of Teachers "made four snow days their number one priority."

Dunn represents Garden City, Livonia, Plymouth-Canton, Redford Union and Wayne-Westland. He had favored the amendment.

"They're calling in their chips," Dunn said of the unions. "They want to demonstrate to their membership

they do have certain powers."

Keith agreed after the vote. "The teachers did a helluva job," he said. "Too bad nobody was lobbying for the kids."

THE HOUSE spent more than an hour last week rejecting the 180-day amendments, branded "hogwash" by Rep. Robert DeMars, D-Lincoln Park.

That was all the rebuttal anyone offered to Keith and Rep. James O'Neill, D-Saginaw, author of similar amendments.

The Keith amendment failed 39-66 with five absent. Those voting yes wanted to require 180 classroom days. Those voting no favored specifically allowing four snow days. The local vote:

Yes — Democrats Keith, John Bennett of Redford and James Koteva of Canton; and Republicans Wilbur Brotherton of Farmington, Gregory Gruse of Madison Heights, David Honigman of West Bloomfield, Gerald Law of Plymouth, Judith Miller of Birmingham and Gordon Sparks of Troy.

No — Democrats Justine Barnes of Westland and Maxine Berman of Southfield; and Republicans Lyn Bankes of Livonia and Mat Dunaskiss of Lake Orion.

The House version is different from the Senate bill and will be sent to a joint conference committee for compromise. Final passage is due this week.

KEITH TRACED how the school

year was whittled from 192 days in the 1960s.

"We found it was 187 days, then 184 days. Rep. E.D. O'Brien feared it was being bargained away (in union negotiations) so he put in an amendment to make it 180 days.

"Someone in the Department of Education decided it wasn't necessary to make up snow days. Then we found the average was 172 days. Now it's time to reverse that trend."

Keith said an education commission on which he served recently recommended after 18 months work that the school year be 200 days. But the state Department of Education advised the panel that every day's extension would cost the state \$36 million, so Keith settled for starting

with a demand for 180 classroom days.

He said the loss of 20 days from the school year meant "kids lose 1 1/2 years of class in their 12-year experience."

NO ONE defended the union point of view during debate, but O'Neill of Saginaw said union leaders made those arguments, which he deplored:

- "The anticipation of snow days is a morale booster."

- "Snow days are not days of rest and rehabilitation but shoveling days."

- Requiring snow days to be made up would mean Saturday sessions that would cause "stress" among teachers.

# Smaller class sizes key to school budget

By Emory Daniels  
staff writer

Smaller class sizes probably is the highlight of the proposed operating budget of Plymouth-Canton Community Schools for 1986-87.

The \$50-million-plus document is expected to be approved tonight by the Plymouth-Canton Board of Education when it meets in regular session at 7:30 at board offices, 454 S. Harvey.

Class sizes were an issue in the last round of contract talks with the teachers union, and also were a key to this month's \$13 million bond issue, which included a new elementary and classroom additions aimed at reducing class sizes districtwide.

The budget proposes certified staff ratios as follows: elementary, 23.0; middle school, 22.0; and high school, 21.0. During the school year just ended (the ratios were 23.5 for elementary, 22 middle school, and 21.5 high school.

Because of the attempt to lower the ratio, plus a project enrollment increase, the proposed budget will add 1 1/2 certified positions plus another seven "contingency" certified staff positions.

IN A NUTSHELL, the proposed budget includes income of \$52.6 mil-

lion, an increase of 4.7 per cent or almost \$2.4 million. Expenses are expected to increase by 7.7 percent or \$3.8 million for a total of almost \$53.5 million.

The difference between income and expenses, if it holds, will result in the ending fund balance dropping from \$3.7 million to about \$2.9 million.

However, the operating budget will be adjusted sometime in February to take into account changes because of the passage of the bond issue. These changes could amount to \$1 million so the adjusted budget could end up \$200,000 in the black.

Items now in the operating budget which will be removed, once the bond sale is formally sanctioned by the state, include: capital outlay, \$400,000; bus purchase, \$400,000; Allen roof, \$155,000; instructional computers, \$17,850; library references, \$26,000; and flooring, \$71,150.

Of the \$52 million in expenses, \$36 million is for salaries, \$5 million for fringe benefits, almost \$3 million for energy costs, and \$1 million in major maintenance. Most of the income, \$39 million, will come from local property taxes.

SOME OF THE highlights of the proposed budget are:

- The tax base is expected to exceed \$1 billion (\$1,055,945,036), which is an increase of some \$51 million or five percent.

- The Fourth Friday enrollment count is expected to increase by 100 pupils to 15,820.

- Utility costs may increase by 7 percent.

- This year it will not be necessary for the school district to borrow to meet operating expenses. The current school year was the first time in 34 years that the district did not have to borrow to meet its cash-flow needs. "This is due, almost totally, to the collection of one-half of our taxes in the summer," explains Ray

Hoedel, associate superintendent for business.

- The budget includes \$801,000 for buses — \$401,000 for the final payment on 26 large-capacity buses and eight special education vans; \$400,000 to buy eight additional buses and four special education vans.

- Some \$325,000 is budgeted for

textbook purchases, an increase of 40 percent or \$92,000.

- Some \$70,000 is budgeted to provide half-time curriculum coordinators for math, science, social studies, and language arts.

- Liability insurance is expected to increase by \$12,000 or 83 percent.

## FBI investigates racial link to arson

By Diane Gale  
staff writer

The FBI is investigating whether a deliberately set fire in an apartment hallway at Honeytree Apartments in Canton was racially motivated.

The tenants are a black family, Clyde and Regina Edmonds, both 31, and daughter, Mondicia, 5.

Edmonds told police her car tires have been slashed twice in the two months they have lived in the complex. On occasion they have also heard banging on the windows "in the middle of the night."

The arson occurred June 8 in Building 25 on Honeycomb Circle. No one was seriously injured.

"I got a message from Honeytree management that someone contacted them and said if we

moved back in there would be trouble," Regina Edmonds said. "I'm the only one of this color over there and there's just no other reason. Someone is constantly picking on us for no reason."

CANTON POLICE DETECTIVE Ernie Sayre said: "She said it was racially motivated, and I believe it was racially motivated."

He declined to comment about Canton's investigation and suspects.

Before Edmonds moved to Building 25 she lived at Honeytree Apartments in Building 33 from 1984 through 1985. She said she had no problems during that time.

"I just felt they didn't want me there," she said about living in Building 25. "It's a lot of little things... You just get a feeling

that things just aren't right. You say, 'Hello,' and no one says, 'Hello,' so you just mind your own business. I pretty much stay to myself anyway."

Both Canton police and FBI agents said they did not believe an organized group, like the Ku Klux Klan, was involved.

It is unknown whether the door or the carpeting outside the apartment unit was set on fire. Due to the excessive smoke many tenants were evacuated at 4:30 a.m.

Edmonds said she and her daughter were asleep in the apartment. She awakened her daughter to go to the bathroom about 3:30 a.m. and heard a scratching at the door.

"But eventually I found out it was a crackling noise because it was on fire," Edmonds said. "When

I looked around the window I saw the fire. I got my daughter out, and then I ran back in to try to find her something to wear. All we were wearing were our pajamas. Then I ran back in and tried to put it out with a fire extinguisher."

Sayre turned the case over to the FBI for an investigation of whether Edmonds' civil rights were violated. If the FBI decides it was racial, it motivated the case will be turned over to the Department of Justice, according to John Anthony, FBI special agent. He also declined to comment on possible suspects.

The justice department will verify whether a violation exists and if a suspect will be charged, Anthony said. The FBI preliminary investigation is expected to be complete within 20 days.

## excursions

### ● SAUDER MUSEUM FARM

Canton Seniors are sponsoring a trip to Sauder Museum Farm and Craft Village in Archbold, Ohio, on Monday, June 23. Departure will be 9 a.m. from Canton Recreation Center with return about 4:30 p.m. The charge of \$23 per person includes transportation, admission to Sauder's, and lunch at the Old Barn Restaurant. For registration, call Canton Seniors at 397-1000, Ext. 278.

### ● PORTAGE LAKE

The Y Travelers have scheduled a three-day, two-night stay at Portage Point Inn, a restored historical inn on Portage Lake and Lake Michigan, June 25-27. The charge of \$239 per person includes bus transportation, two nights accommodations, two breakfasts, two dinners, lunch en route and two days of touring in the Manistee area. For reservations, call the YMCA at 453-2904.

### ● TORONTO TRIP

The Y Travelers are sponsoring a trip to Toronto July 1-2. The charge of \$80 per person includes bus transportation, one-night accommodation at Carlton Inn, Harbour Cruise of Toronto's harbor and island, and a visit to Ontario Place. For reservations, call 453-2904.

### ● CHESANING HERITAGE

Plymouth Recreation in cooperation with Bianco Travel & Tour will sponsor a trip to Chesaning, Mich., July 9. The charge of \$31.50 per person includes bus transportation, en-route snacks, lunch at the Chesaning Heritage Hotel, tour of Chesaning, shopping on the boulevard, tour of the Curwood Castle in Owosso, and a tour of the Montrose Orchards. For information, call 455-6620.

### ● DETROIT SHOWCASE

Plymouth Recreation and Bianco Travel is sponsoring a tour of Detroit which for \$38 per person includes the Star of Detroit boat cruise, a brief city tour, shopping at Trapper's Alley, and the Eastern Market. For information, call 448-6620.

### ● CHESANING SHOWBOAT

City of Plymouth will sponsor a trip to the Chesaning Showboat to see Marie Osmond entertain on July 14. The charge of \$85 per person includes transportation, a ticket to the showboat, dinner, snack and beverage service.

### ● MACKINAC ISLAND

The Y Travelers have scheduled a trip to Mackinac Island July 23-24. The charge of \$119 per person includes bus transportation, two-day, one-night accommodations at the Island House Hotel. For reservations, call the YMCA at 453-2904.

### ● TOLEDO THEATER

A trip to the Star Theatre in Toledo to see the Tommy Dorsey Orchestra will be sponsored Aug. 9 by the city of Plymouth Parks and Recreation Department in cooperation with Bianco Travel and Tours. The charge of \$37.50 per person includes transportation, dinner at Walli's Supper Club, and a ticket to the performance.

### ● MISSISSIPPI RIVER

City of Plymouth Parks and Recreation, in cooperation with Bianco Travel & Tours, will sponsor a four-day, three-night Mississippi Belle & the Amana Colonies trip with departure on Monday, Aug. 11. The charge of \$339-per-person based on double occupancy includes transportation, three nights hotel accommodations, a daylong cruise with breakfast, lunch and dinner on the Mississippi River aboard the Mississippi Belle, a dinner in Davenport, Iowa, lunch in the Amana Colonies, dinner/theater, a tour of Herbert Hoover's birthplace, and tour of Amana Colonies. For information, call the recreation office at 455-6620.

### ● FLINT THEATER

The Y Travelers will be taking a day trip to Star Theatre in Flint 1-8 p.m. Saturday, Aug. 23, to see Jim Nabors and Brenda Lee. Dinner will be at Walli's Supper Club (on your own). The charge of \$38 per person includes bus transportation, theater tickets and snacks en route. For reservations, call the Plymouth Community Family YMCA at 453-2904.

### ● WISCONSIN DELLS

The Y Travelers is offering a Door County/Wisconsin Dells Trip Aug. 24-30. The charge is \$449 per person based on double occupancy. For information on trips, call 453-2904.

### ● AFRICAN LION SAFARI

Plymouth Recreation and Bianco Travel & Tours are offering a trip to African Lion Safari in Ontario, Canada, on Aug. 28. The price of \$45 per person includes bus, lunch, and admission to African Lion Safari. For information, call 455-6620.

### ● ALPINE HOLIDAY

City of Plymouth Parks and Recreation, in cooperation with TM Travel Associates Inc., is sponsoring a 12-day trip to Austria, Belgium, Switzerland, and Germany. The tour leaves Detroit Sept. 12 and returns Sept. 24. The charge of \$1,400 per person includes air transportation, hotel accommodations, and breakfast and dinner daily. For information, call the department at 455-6627.

### ● STRATFORD FESTIVAL

Plymouth Recreation and Bianco Travel will sponsor a trip to the Stratford Festival on Sept. 18. The price of \$38.50 per person includes bus transportation, lunch at the 7 Dwarfs Restaurant in Lambeth, Ontario, and a Stratford Festival ticket to see a matinee performance of "Cymbeline." For information, call 455-6620.

### ● ELORA MILL & MENNONITE COUNTRY

City of Plymouth Parks & Recreation Department in cooperation with Bianco Travel & Tour will be sponsoring a two-day/one-night trip to Elmira, Ontario (Mennonite country), and to the Elora Mill. The tour date is Monday, Sept. 29, and the charge is \$125 per person based on double-occupancy. The tour includes bus transportation, two days-one night at the Elora Mill, a full-course dinner at the mill, a lunch at Elmira, cocktail party on arrival, historic tour of Elmira, Elora area tour, and evening entertainment. If interested, call 455-6620.

### ● UPPER NEW ENGLAND

City of Plymouth Parks and Recreation, in cooperation with Bianco Travel & Tours, is sponsoring a 10-day, nine-night trip to Vermont, New Hampshire, Maine and Nova Scotia, with departure set for Friday, Oct. 3. The charge of \$819 (based on double occupancy) includes bus transportation, accommodations, two breakfasts, one lunch and seven dinners and tour escorts. Information available by calling 455-6620.

### ● CAPE COD COLOR TOUR

The Y Travelers have scheduled a Cape Cod Color Tour Oct. 5-11. The charge of \$489 per person includes bus transportation, a first-night stay at Waterville, four nights at Hyannis and one night in the Holiday Inn in Auburn, N.Y. The trip package includes air breakfasts, four dinners and tours of Boston, Cape Cod and Martha's Vineyard. A \$30 deposit is needed. For reservations, call the Plymouth Community Family YMCA at 453-2904.

# MAYBE NOW IT'S TIME YOU GAVE US A FUN ASSIGNMENT

Your FYI consultant can help you select clothes for leisure time activities and parties. And he or she can do it by Saturday night. There is no charge for the services of FYI.

For the FYI office nearest you, call toll-free  
1-800-328-1463.



WARDROBE SHOPPING SERVICE

hugoboss

# Police map attack on rowdyism and trespassing

Continued from Page 1  
 ton residents, 27 to Plymouth Township youths, 13 to persons who live in Livonia and nine to city residents. More than half were issued at

Farmer Jack, 7-Eleven and Cobbler Shoes. Those figures were provided by Mike Richardson, administrative assistant in the police department.

**MOST YOUNG** people who come into town don't want to get into hassles with anyone, Myers believes. However, thoughtlessness can arise in the form of loud radios,

squealing tires and littering. "It's escalating," he said. More police writing more tickets may take care of cruisers who get out of hand, Myers suggests. He also suggests tolerance and consideration for others. "Squids (punks) tell us the rea-

son they go down to Penniman is they want to get noticed," the chief said. "It's easier to sit on a corner and get noticed than just about anything, I guess. "Peoples' expectations and what reality is are far different. They expect we can put a lid on it. We can

reduce it. We're not going to eliminate it. "None of this should let people get paranoid about Plymouth and stay away," Myers said. "People haven't been mugged, beat up. Vandalism has been minimal. Instead of staying away, everybody just go downtown."

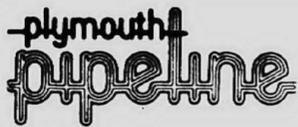

Continued from Page 1

**AN IDEAer:** Barbara M Church, science coordinator of Plymouth-Canton Community Schools, has been accepted to a 1986 Institute for Development of Educational Activities (IDEA). The program, entitled "Science for all students," is co-sponsored by the National Science Teachers Association. The institute will be held June 24-26 at Smugglers' Notch, Vermont.

Each year IDEA selects outstanding educators to participate in one or more programs to expose them to the latest ideas relevant to elementary and secondary schools. At the Smugglers' North Institute, participants will come from more than 30 states. The emphasis of discussions will be on science programs for students who will not be entering science as a vocation.

**SILLER SUPERIOR:** Manfred N. Siller of Plymouth, a compliance officer with the U.S. Department of Agriculture's Food Safety and Inspection Service, has received the department's superior service award at an awards ceremony in Washington, D.C.

He received the award for outstanding performance in taking action against a chronic problem plant. Siller was part of a team which shut down an Ohio meat firm which repeatedly and clandestinely attempted to circumvent inspection requirements. The case required extensive documentation of complicated legal evidence in a highly charged atmosphere, reported Secretary of Agriculture Richard Lyng. Born in Sartscha, Yugoslavia, Siller had been with Food Safety and Inspection Service for 16 years. He attended Kishwaukee and Black Hawk East Colleges in Illinois and Goddard College in Vermont.

**SMOKE ATTACK:** Last week the attack on smoking in public mounted. While the state House passed a bill banning smoking in public buildings, except in designated areas, late Sen. Robert Geake, R-Northville, (whose district includes Canton and Plymouth) has introduced Senate Bill 792, which prohibits smoking on school property

except for instructional use and would set fines between \$25 and \$100 for each offense.

"I've introduced this bill several times in the past but it has not had much success," said Geake. "But with the recent passage of SB 196 banning smoking in public work places, and passage of legislation setting aside a certain number of tables for non-smokers in restaurants, there is movement toward more equitable rights for non-smokers." Geake said he introduced similar measures in 1981 and 1983 with the support of the Department of Public Health. Noting students are at an impressionable age, Geake added: "If they don't see their instructors, school administrators — and, most importantly, their peers — smoking, they may avoid smoking for life."

## Plymouth Observer

(USPS 436-360)  
 Published every Monday and Thursday by Observer & Eccentric Newspapers, 36251 Schoolcraft, Livonia, MI 48150. Second-class postage paid at Livonia, MI 48151. Address all mail (subscription, change of address, Form 3569) to P.O. Box 2428, Livonia, MI 48151. Telephone 591-0500.

**HOME DELIVERY SERVICE**  
 Newsstand per copy, 25c  
 Carrier monthly, \$2.00  
 Mail yearly, \$40.00

All advertising published in the Plymouth Observer is subject to the conditions stated in the applicable rate card, copies of which are available from the advertising department, Plymouth Observer, 489 S. Main, Plymouth, MI 48170. (313) 459-2700. The Plymouth Observer reserves the right not to accept an advertiser's order. Observer & Eccentric advertisers have no authority to bind this newspaper and only publication of an advertisement shall constitute final acceptance of the advertiser's order.

*We need you!*

We need carriers for Observer & Eccentric routes.

Call 591-0500 to find out all about it.

SALE SALE SALE SALE SALE SALE SALE

Pixieland CHILDRENS STORES

Pre - 4th of July

SUMMER SALE

STARTS TODAY

30% TO 50% OFF ORIGINAL PRICES

ALL SUMMERWEAR BOYS & GIRLS

Girls Spring & Summer <b>DRESSES and COATS</b> <b>1/2 OFF</b> <small>original prices</small>	All Boys & Girls <b>SWIMWEAR and SLEEPWEAR</b> <b>30% OFF</b> <small>original price</small>	Large Selection of Girls <b>SPORTSWEAR</b> • Slacks • Tops • Shorts • Blouses  <b>1/3 OFF</b> <small>original prices</small> Infants & Toddlers <b>up to 40% Off</b>
All Boys Size 4-14 <b>PANTS</b> <b>1/3 OFF</b> <small>original price</small>	Spring & Summer <b>KNIT SHIRTS</b> <b>30% OFF</b> <small>original price</small>	

New 1986 Styles In

OUTERWEAR

• Snowsuits • Coats • Jackets  
**UP TO 30% OFF**  
Original Prices

• Weather Tamer • Pacific Trail • Rothchild  
 • Mighty Mac • HBI

NOTICE: Get an additional 10% OFF on all outerwear through August 15, 1986.  
Limited layaway plan.

WE ARE YOUR OFFICIAL GIRL SCOUT AGENCY

Pixieland

LIVONIA:  
 NEWBURGH PLAZA  
 464-6500

Mon. thru Fri. 10-9  
 Saturday 10-6  
 Sunday 12-5

6 Mile at Newburgh

ALE SALE SALE SALE SALE SALE SALE

VIC TANNY

A great body is worth working for.

If you want a great body, you've got to work for it. You've got to push, pull and sweat for it. You've got to find the best workout program around and go for it.

If you want a great body, you've got to join Vic Tanny. Because only Vic Tanny knows how to take the world's number one workout program and make it work for you. That's why Vic Tanny offers you all the latest facilities and equipment, plus a variety of total fitness programs, including circuit, weight training and nutritional guidance, to make working out worth your while.

This is your final week to get 2 years of membership for the price of the first year alone, so hurry. Call Vic Tanny today and get a body that's worth working for.

2 YEARS FOR THE PRICE OF 1

FINAL WEEK

Hurry offer ends June 29th!

VIC TANNY HEALTH & RACQUET CLUB

40700 Ann Arbor Rd. — Call... 459-8890

Open Mon. - Fri. 8 a.m. - 6 p.m. Sat. and Sun.

# County names citizens group for parks study

By Teri Ban  
staff writer

The Wayne County park system will be the subject of a special citizens' task force to determine how it should be maintained and funded in the future.

County officials plan to announce the starting date of the special probe, delayed for almost two months now, sometime this week.

No one is leaving out the possibility that a request for earmarked millage could be coming up and an examination of that will be one of the charges before the now 19-member body. Some say a ballot issue could be prepared for next November's general ballot if that aspect of the study gains political acceptance in this election year.

"It's become increasingly more difficult to get money out of the general fund (for parks funding)," said county commissioner Curt Boller, D-Brownstown, the task force's commission proponent. "I personally think that the system won't be funded another year and it's a matter of survival because of reductions in revenues."

AS A NON-MANDATED government service, parks funding has been the topic of numerous budget battles, particularly between Detroit commissioners and representatives of out-county areas, where the bulk of the system's services are located. Among the system's seven parks, the county operates a golf course in Dearborn Heights and a boat marina in Trenton.

As of late last week, 17 members had been selected from across the county, though primarily from western Wayne and downriver areas, with Northville Township supervisor Susan Heintz the likely candidate to chair the board. Heintz, a Republican candidate for county commission from the Livonia-Plymouth-Northville communities, is the choice of Wayne County Executive William Lucas, another Republican party member.

Besides a millage hike, Boller said the task force will be asked to look



Michael Legg appointee



Susan Heintz appointee



Ralph Tack appointee

at a wide-range of options, and draft suggestions for the "total operation" of the parks. Possibilities range from increasing user fees including new fees at the golf course to an arrangement with the Huron-Clinton Metropolitan Parks Authority.

The task force members will not receive any direct reimbursement for their work.

THE TASK FORCE has had strong backing from county parks director Eric Reickel who argued a year ago that developing a parks program and even simple maintenance would become increasingly difficult without dedicated funding.

Currently, the park system receives \$2.5 million from the county's general fund. But funding battles between out-county commissioners and Detroit representatives for park support have become routine and are certain to heighten as revenue reductions are made. Earlier this year Detroit commissioners attempted to remove \$500,000 from the park system, though eventually the money was restored. Already this year, Lucas has declared a hiring freeze to curb costs in light of anticipated budget shortfalls and last week made plans for nearly \$3 million in select departments.

COMMISSION appointments to the task force include: Ronald Reinke, Livonia parks director; Robert Beeny of Wayne; Ralph Tack, assistant to the mayor in Westland; Gloria Schermesser, an aide to downriver commissioner William Suzore; William Kreger Sr., former chairman of the Huron-Clinton Parks Authority; Tom Hill of Trenton; and Leonard T. Halas.

Alternates include: Ted Anders; Harold Popp Sr., manager of the Wyandotte Ice Rink; Tom Anderson, former state representative and chairman of the Michigan Department of Natural Resources; William Davis, a Trenton banker and active in maintaining Elizabeth Park there.

Lucas' appointments, still incomplete by late last week, include:

trict GOP chairman; Hines Proctor, chairman of American Sun Corp. in the downriver area; Alan Swormsted, a partner with the Detroit accounting firm of Deloitte Haskins & Sells; Nancy White, a representative of the League of Women Voters; and Boller.

The group will work closely with research staff from the executive's office and also Reickel's office in forming a recommendation to Lucas and the commission.

ORIGINALLY planned to begin last April 15, the task force was delayed when disagreements arose between Lucas' office and commissioners over appointments to it. Last March the commission drafted an ordinance that called for 15 members with each side appointing seven and Lucas naming the chairman.

But the numbers were forced up when commissioners named nine members, causing Lucas' administrative aide Ron Chapman to de-

mand his office get an equal share of appointments plus naming the chairman. The task force size now stands at 19.

Boller had charged that Lucas' appointments were politically motivated, particularly because of candidate Heintz' inclusion, and Lucas' selection of a GOP party boss as another member. In contrast, he said, the commissioners had selected "highly interested, not politically motivated people."

Chapman countered that Heintz, for instance, has a "very strong interest and involvement in Edward Hines Drive and the whole area" besides politics. Lucas had also named as one of his appointments Boller himself, as proof of his good will, said Chapman.

Boller said he was undecided on whether he would serve on it. Facing a re-election campaign at this time, he maintained it would be best to keep the task force as apolitical as possible.

**WHEELCHAIRS**

**KINGSBORO PHARMACY**  
A ORTHOPEDIC SUPPLIER

25329 Five Mile  
Just West of Beech Dale  
Redford 535-9480

**BERGSTROM'S**  
Plumbing • Heating • Cooling Specialists  
Since 1957  
CALL 427-8082

High Efficiency Air Conditioning  
"THE SUCCESSOR" FROM \$1249<sup>00</sup>  
INSTALLED AND RUNNING  
1 1/2 TON CAPACITY  
"0" Down Financing Available MODEL 38EH018

TWO SERVICE CENTERS TO SERVE YOU  
**REDFORD** 25429 W. Five Mile Road 532-2160  
**FARMINGTON HILLS** 2884 Orchard Lake Road 563-2225



## JCPenney Custom Decorating CUSTOM COUPON SALE

## Abortion issue not over yet

By Tim Richard  
staff writer

State legislators probably aren't finished battling over the Medicaid abortion issue, even though both houses voted emphatically to prohibit them.

Gov. James J. Blanchard this week is likely to use a gubernatorial veto for the 14th time to strike down such a rule.

"The debate has been over tactical procedures," Senate Majority Leader John Engler, R-Mount Pleasant, said matter-of-factly as the upper chamber added its 25-12 stamp of approval to the social services budget with anti-abortion language.

IF BLANCHARD vetoes the entire \$1.9 billion measure because it lacks the \$6 million abortion item, lawmakers have these options:

- They can repass the measure minus the section under which 18,500 low-income women get Medicaid-funded abortions annually.

- They can try for a two-thirds majority to override the veto. That will be easy in the 38-member Senate, where there are as many as 30 anti-abortion votes. But the 110-member House this session has fallen in two votes shy of the 74 votes needed to override.

- They can follow the advice of House Speaker Gary Owen, D-Ypsilanti, and pass a "continuation" budget (with abortion money in it). They can let the gubernatorial candidates debate it until Nov. 4 and afterwards pass the version requested by the winner.

SUBURBAN SENATORS last week showed they were overwhelmingly against Medicaid-funded abortions.

The test vote came when the Senate rejected, 12 in favor and 20 against, a move to strike the so-called "Dillingham amendment" language out of the budget bill.

Opposed — and thus opposed to Medicaid abortions — were Doug Cruce, R-Troy, Richard Feasler, R-West Bloomfield, Robert Geake, R-Northville, Rudy Nichols, R-Waterford, and Patrick McCollough, D-Dearborn.

Absent was William Faust, D-Westland.

ABORTION MONEY wasn't the only loser in the Senate's debate over tactics.

Geake, who heads the social services appropriations subcommittee, saw his major effort shot down. He had prepared a social services budget with "Dillingham" anti-abortion language in it, but with a half-dozen major changes compared to the House budget.

**"TRUST THE WONDER OF LASER"**  
Laser light replaces conventional foot surgery to help give much needed relief of...

**FREE EXAM WITH THIS AD**  
\*Initial Consultation free with this ad excluding lab test, X-rays and treatments  
Most Major Medical Plans Accepted

ADVANCED  
PODIATRY  
CLINICS

**IN OFFICE LASER**  
For Your Convenience  
**DAVID A. FRIEDMAN, D.P.M.**  
16975 Farmington Rd.  
(Corner of 6 Mile)  
**LIVONIA 525-4400**

**Classic Interiors**  
Fine Furniture... Where Quality Costs Less  
30002 Middlebelt Rd. (S. of 6 Mile)  
Livonia • 474-8000  
Mon., Thurs. & Fri. 10 a.m. - 6 p.m. OPEN SUNDAYS 1-5

NOT UNLESS YOU SEE DR. CLOUD...  
...AND BECOME HEALTHY, ZESTFUL, AND BEAUTIFUL AS I HAVE

**Cloud Chiropractic Center**  
30000 Jay Rd. (at Hwy 24)  
Westland 453-2266

LATER... I NOW PRODUCE YOU HUSBAND AND WIFE  
THERE'S THE MOST LEGAL BUT THE MOST POWERFUL LINE!!!  
**Cloud Chiropractic Center**  
30000 Jay Rd. (at Hwy 24)  
Westland 453-2266

IT'S THE LAW:  
Nursing home patients who qualify for Medicaid may legally retain certain monetary assets. Write or call for more information. It's all in our helpful booklet "DID YOU KNOW?"

**FREE NO COST OR OBLIGATION: USEFUL MONEY-SAVING FACTS!**

James Will

**WILL HARRY J.**

(Phone us or mail in this coupon.)  
Yes, I am interested in more details. Please send me Report #1 "Did You Know?"

Name: \_\_\_\_\_  
Address: \_\_\_\_\_  
City: \_\_\_\_\_ State: \_\_\_\_\_  
Zip: \_\_\_\_\_ Phone: \_\_\_\_\_

**FUNERAL HOMES, INC.**  
3 LOCATIONS — ALL NEAR FREEWAYS  
Redford — 25450 Plymouth Rd.  
Livonia — 37000 Six Mile Rd. 937-3970  
Dearborn — 4418 Livonia Ave.

**40% off Draperies**

Choose from our entire line of drapery fabrics. Sale includes fabric, labor, lining and installation. 30% off all top treatments.  
Coupon valid one time only. Minimum cash value 1/20 of one cent.  
Coupon expires July 12, 1986.

**Check out these savings**

**50% off Sheers**

Entire line of sheers on sale at 50% off fabric, labor, lining and installation. 35% off all bedspreads and related items.  
Coupon valid one time only. Minimum cash value 1/20 of one cent.  
Coupon expires July 12, 1986.

**Check out these savings**

**50% off Mini Blinds**

Choose from 1/2 inch or 1 inch blinds in wood or metal. Also save 50% on micro blinds.  
Coupon valid one time only. Minimum cash value 1/20 of one cent.  
Coupon expires July 12, 1986.

**Check out these savings**

**50% off Verticals**

Choose from our entire selection of vertical blinds in many decorative finishes and fabrics.  
Coupon valid one time only. Minimum cash value 1/20 of one cent.  
Coupon expires July 12, 1986.

**Check out these savings**

Call us. We'll send you a decorator... Free

Northland 520-4270, Southland 374-0210, Eastland 322-2220,  
Westland 22-2011, Farmington 522-2216, Cantonwood 322-2216,  
Livonia 247-2420, Dearborn 248-7422, Riverfront 748-7777,  
Northland Center 248-2220.

**JCPenney Custom Decorating**

# SUMMER Specials

# SUMMER Specials

# SUMMER Specials

# SUMMER Specials

## 15TH ANNUAL

## PLYMOUTH'S OLD VILLAGE

# DEARIE DAYS MAY 99

DO YOU REMEMBER?

**SUNDAY  
JUNE 29  
12-8**

**SIDEWALK SALES**  
Old Fashioned  
Bargains  
Entertainment  
Arts & Crafts  
Antiques



- 1:00 p.m. Sweet Adelines
- 2:00 p.m. Dulcimers
- 3:00 p.m. Plymouth Fife & Drum Corps
- 4:00 p.m. Bike Decorating Parade from downtown Kellogg Park to Old Village for judging
- 5:00 p.m. Baked Goods Beard & Mustache and Old Fashioned Costume Contests at the Gazebo



**CLOWNS    BLACKSMITH    CALLIOPE**

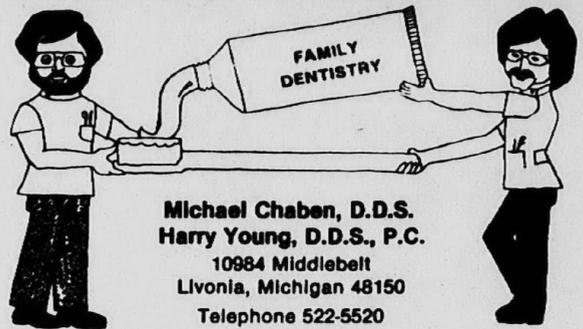

**Michael Chaben, D.D.S.**  
**Harry Young, D.D.S., P.C.**  
10984 Middlebelt  
Livonia, Michigan 48150  
Telephone 522-5520

## Does Your Loose Lower Denture Inhibit Your Eating and Speaking?

The Mandibular Staple Implant May be the Solution to Your Problems.  
It Features

1. 16 Years of highly successful clinical usage
2. Surgery covered by many medical insurances and dentures covered by most dental insurances.
3. Non-complicated and affordable denture fabrication or the possibility of using an existing denture over the implant.



Implant Balls in Mouth

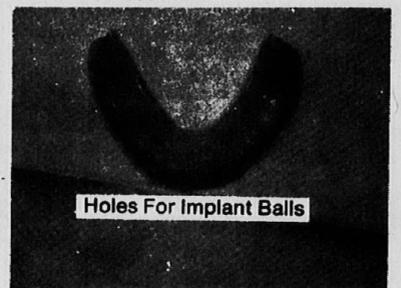

Underside of Implant Denture

Call for **FREE** consultation to determine acceptability

**522-5520**

## ATTENTION HOME BUILDERS!

NOW AVAILABLE AT

## MATHISON'S Bath Shoppe

**ATI** **ACRYLIC WHIRLPOOL BATHTUBS**

**WITH JACUZZI® JETS**

*The Affordable Luxury*

*Acrylic Practicality, Gracious Styling, and Natural Warmth and Elegance.*



ONE, TWO OR FOUR PERSON WHIRLPOOL TUBS AVAILABLE

5 YEAR WARRANTY ON ATI TUBS

**BEAUTIFY YOUR BATH WITH THE CARIBBEAN COLLECTION OF TUB AND SHOWER ENCLOSURES BY ATI**



ATI 41 TUB & SHOWER WITH GRAB BAR

This is part of the beautiful difference that practical Acrylic by ATI will make in your bath. Total one-piece construction means there's no tile or grout, no seams for mold and mildew. The surface is color-fast acrylic; not a sprayed on or painted surface. Recessed sides eliminate water puddles on the floor. Beautifully contoured seat and shelves are molded into the tub walls. Available in 15 decorator colors and 3 sizes: 60" Caribe tub/shower, 48" Cayapo shower, and 36" Aruba shower.

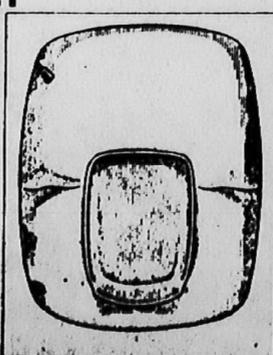

ATI 60 TUB & SHOWER WITH SEAT

See them today at **MATHISON HARDWARES**  
**LIVONIA AND CANTON STORES ONLY**

6130 Canton Center  
CANTON 488-6440  
28243 Plymouth Road  
LIVONIA 522-8635

# \$15.

prescription sunglasses

Compare anywhere for \$60 to \$85!

First Optometry wants you to look cool this summer at a real HOT PRICE! Just \$15 for a pair of new designer styled PRESCRIPTION SUNGLASSES with your examination and first pair of glasses. Choose from a full selection of men's and women's frames in a bouquet of stylish new colors.

But call today for your appointment, because this price will cool off soon.

## 1ST OPTOMETRY

eye care centers

MICHIGAN'S LARGEST GROUP OF INDEPENDENT OPTOMETRISTS WITH OVER 30 OFFICES THROUGHOUT MICHIGAN INCLUDING:

**LIVONIA 422-5855**

15540 Middlebelt

Dr. Marvin Levine, Optometrist

C-10

Single vision lenses only. Offer good at participating offices only. Prior orders, discounted programs and Federally funded programs not included. Offer valid for individuals 16 years and older. This limited time offer may end without notice.

**SUMMER  
Specials**

**SUMMER  
Specials**

**SUMMER  
Specials**

**SUMMER  
Specials**

Monday, June 23, 1986 O&E

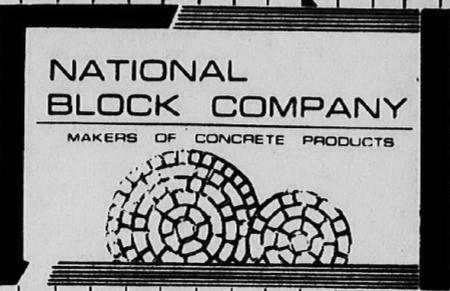

"FUNNY HOW THE  
SIMPLE THINGS IN  
LIFE LOOK THE BEST  
AND LAST THE LONGEST"

Paving stones can be used commercially or for residential purposes such as patios, driveways, walkways and pool sides and can withstand extreme temperatures and heavy traffic. Unlike asphalt or poured concrete, frost or severe temperature changes leave them unaffected.

Your average material cost is approximately \$1.62 sq. ft. Materials performance guaranteed.

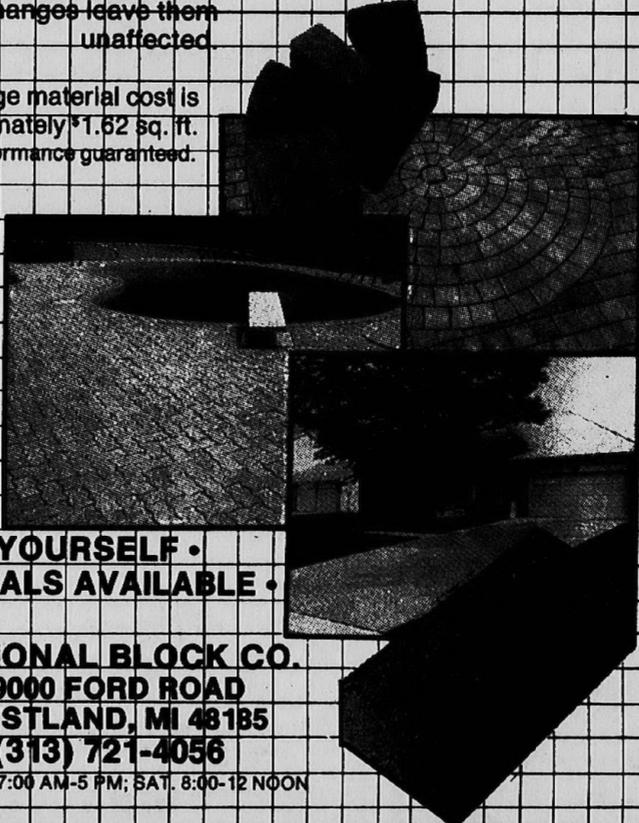

FREE ESTIMATES  
EXPERT  
INSTALLATION  
AVAILABLE

• DO IT YOURSELF •  
• TOOL RENTALS AVAILABLE •

**NATIONAL BLOCK CO.**  
39000 FORD ROAD  
WESTLAND, MI 48185  
(313) 721-4056

Mon.-Fri. 7:00 AM-5 PM; SAT. 8:00-12 NOON

**50%  
OFF**  
**ALL INVENTORY  
GOING OUT OF BUSINESS  
EVERYTHING MUST GO**

**BEDROOMS,  
LIVING ROOMS, DINING ROOMS, DENS  
RECLINERS, TABLE LAMPS, PICTURES**  
**FAMOUS NAME BRAND FURNITURE FROM**  
Flexsteel, Bassett, Stratolounger, Serta, Robinson, Virginia House, Stanley, Stratford, Broyhill, Schweiger, Dixie, Mersman & More.

Furniture  
Discount  
Center, Inc.

2921 S. Wayne Rd.  
Wayne, Mich.  
728-1060

Quality You Can Trust  
At A Price You Can Afford

FREE  
DELIVERY

ALL SALES  
FINAL

Going Out Of  
Business Sale  
Permit #1986-02  
City of Wayne



**Special Lasky Clearance  
Purchase!**



This set combines attractive looks with convenience - exactly what you want in a bedroom. Shaped moldings are a stylish part of our Plymouth Oak Copenhagen Collection. Priced ready to assemble! While they last!

Double Dresser	\$149
Chest	\$129
Headboard	\$69
Mirror	\$29
Nite Stand	\$69

Assembly Also Available!



**Lasky Clearance Center**  
28795 Plymouth Rd.  
Livonia  
**427-8600**



Open Daily 9-9 P.M.  
Sunday 12-6 P.M.

**LAST WEEK**

TILL SUNDAY, JUNE 29th

**ALL-AMERICAN  
WATERBED**

**90 DAYS  
SAME AS CASH**  
• NO PAYMENTS  
• NO FINANCE CHARGE  
• NO DOWN PAYMENT

PLUS

**PLUS —  
SAVE ON  
EVERY WATERBED  
EVERY CHEST  
EVERY DRESSER  
IN OUR  
STOCK!**

**FREE**  
\$175<sup>00</sup> EXTRAS

WITH ANY WATERBED  
IN OUR INVENTORY

**OUR BEST  
ENERGY SAVER!**

THE MOST DELUXE WATERBED PACKAGE OFFERED ANYWHERE. IN ADDITION TO YOUR HEADBOARD/FRAME & PEDESTAL/DECKING/FILL KIT YOU GET:

- ✓ SOLID STATE ENERGY SAVING HEATER. 50W More Efficient Than Standard Heater. 5 Year FULL WARRANTY. SAVE \$\$\$
- ✓ SAFETY STAND-UP ENERGY LAMPS With Built-In Aluminum Heat Reflectors. Saves Minimum 14% Heat Loss \$\$\$
- ✓ "THERMO" HEAVY DUTY MATTRESS PAD - Locks In Mattress Heat - Protects Wear on Vinyl Mattress - Sleep More Comfortably - Mattress Lasts Longer \$\$\$
- ✓ EXTENDED LIFE-TIME TRADE-IN WARRANTY - ON ALL PRODUCTS (WE PAY THE FACTORY INSURANCE CHARGE)
- ✓ OUR BEST L-CORNER GOLD FREE FLOW MATTRESS - With Extended Warranty 5 Years.

**— SPECIAL FACTORY PRICES —  
ALL PRICED UNDER \$399 SAVE UP TO \$550**



\$25  
Monthly



\$25  
Monthly

**Waterbed Store**

7250 MIDLANDLY  
CORNER OF WARREN  
HOURS  
10-6 MON-FRI  
10-5 SAT.  
12-5 SUN.  
NEXT DOOR TO BANK 'N TRUNKLE  
ALSO GENERAL TRADING CENTER  
PHONE  
422-5553



Debra Winger and Robert Redford play attorneys who work together to try to help clear her client in "Legal Eagles."



the movies  
**Dan Greenberg**

## 'Legal Eagles' are quite a pair

The style and charm with which Debra Winger and Robert Redford perform as "Legal Eagles" (PG) far outweighs occasional plot discrepancies in this romantic comedy-thriller.

In the high fashion of Tracy and Hepburn or Cary Grant and Grace Kelly, Winger and Redford team up as an unlikely couple with a major romantic and legal problem: Chelsea Deardon (Daryl Hannah).

A third problem is Hannah's acting, which consists of pouts interspersed with sullen, deadpan expressions framed by her long, straight blonde hair. Apparently this passes for sexy performance in some quarters but I find it annoying. Good acting involves a great deal more than appearances.

Hannah's pouting, however, does work well in her role as Chelsea Deardon, daughter of noted artist Sebastian Deardon (James Hurdle), who young Chelsea (Mary Alison Griffin) had seen die during a fire at her 8th birthday party in 1969. As a child of such trauma, Chelsea is entitled to her sullen, withdrawn visage, quite fitting of Hannah's "acting" ability.

AFTER THE FIRE, we move quickly to the present where Chelsea, now a noted performance artist, has been arrested for trying to steal the painting her father had given her as a birthday present.

Its present owner, Forrester (John McMartin), it turns out, is a partner of art gallery owner Victor Taft (Terrence Stamp) and Joe Brock in defrauding Sebastian Deardon. Brock was jailed for tax evasion when his partners turned on him, and he died shortly after serving his sentence.

Chelsea's attorney, Laura Kelly (Winger), approaches Assistant District Attorney Tom Logan (Robert Redford) with the presumption that there's more to the case than attempted theft of a painting. Kelly becomes romantically attracted to Logan while convincing him to help.

Kelly and Logan had faced off in court earlier as the handsome assistant D.A., currently in line as the next D.A., defended the public interest against Kelly's imaginative and unorthodox defense of various social malefactors.

While Logan is generally suspicious of Kelly's tactics, in the Chelsea Deardon case those tactics get his attention, and he begins a joint, but unofficial, cooperation in Chelsea's defense. That defense is strengthened when Detective Kavanaugh (Brian Dennehy) brings Kelly an insurance file on the Deardon paintings for which \$2.5 million was paid after the fire.

ALL THIS IS quite involved — and there's much more — but its resolution is the adventuresome backdrop for the Winger-Redford romance. That romance and their

slick repartee is the stylish centerpiece of "Legal Eagles."

Winger and Redford work well together. Redford's debonair manner and bright, blonde handsomeness are set off by Winger's somber dress, which subdues her physical appeal in favor of an efficient, legal exterior. But sobriety is only apparent in her clothing, and her outrageous courtroom tactics counterpoint Redford's more conventional legal demeanor. She, in turn, is physically graceful while Redford is rather klutzy.

The dialogue is swift and suave but the greatest attraction is Winger and Redford's delivery. Their acting, and interacting, set against a Manhattan backdrop, are "Legal Eagles' greatest asset.

One element of that Manhattan setting, Victor Taft's Art Gallery, bears special mention. While the exteriors were shot on 57th Street in New York, the interiors were done at Universal Studios with more than \$12 million of art work lent by private collectors, museums and numerous New York galleries.

Although Hollywood has long been noted for its maniacal pursuit of surface realism, one has to ask what purpose is served by such authenticity. Is there one person in a million who can distinguish between a filmed original and a filmed reproduction?

ASSOCIATE PRODUCER/Art Consultant Arnold Glimcher, who is also director of the Pace Gallery, felt otherwise: "We went to a lot of trouble to have originals in the film because the difference between the impact and the power of real art and that of reproductions is the difference between a real event and a fictional event."

Which doesn't make a lot of sense — because the film is a fictional event whose appeal is how it looks and what it says, rather than whether or not it is true. The status game, what's really involved, is flawed, and they wasted a lot of money, which could have been better spent — polishing the script, for example.

Several highly improbable situations ought to have been made more plausible. It is highly unlikely that Logan, portrayed by Redford as pleasantly clumsy, could have cranked up a forklift and driven it through a metal door in under five seconds, nor it is reasonable to assume that the multi-million-dollar Taft Galleries were such a tinderbox that they became a roaring inferno in seconds. No sprinkler system? No alarms? Please...

The viewers' patience is tried by such discrepancies, particularly in face of extraordinary efforts to photograph authentic paintings. However, in spite of such incredible events, "Legal Eagles" is an entertaining two hours filled with a lot of Winger-Redford style and grace.

# Mitzi Gaynor's show dazzles

By Ethel Simmons  
staff writer

Mitzi Gaynor opened the Meadow Brook Music Festival on Wednesday night, with an electric performance of musical numbers featuring sensational costumes by Bob Mackie, and nine guys for backup.

The weather cooperated beautifully for the outdoor setting at Baldwin Pavilion on the Oakland University campus in Rochester Hills. Gaynor was a sizzling, eye-filling star from her first number with the guys — she in a spangled red and gold costume, singing "I'm So Excited" — through to the last of the many high-voltage numbers, with the guys in zoot suits and Gaynor dancing to "Sing, Sing, Sing."

For most of the show Gaynor was moving fast, her curvaceous figure accented by the dresses, many slit up to the top of her shapely legs. Choreography was lively and the costume changes frequent.

Besides the song-and-dance numbers, Gaynor did a couple of skits.

For the first one, early in the show, she talked about what it was like being a Beverly Hills matron. This was only so-so, but the skit she did later in the show, as Dr. Ruth, was hilarious. She imitated the sex therapist's walk, accent and giggle. She read and gave zany answers to listeners' typical questions about their sex lives.

GAYNOR ALSO told the audience a little about herself. "One year and six days ago, I quit smoking!" she shouted out. She said, "I've been married 31 years and I'm still a Virgin." She called Detroit "De-twa," with the accent on the latter syllable, and said, "I went to grammar school here."

The first half of the show included a big production number based on hometowns. Guys in the chorus were dressed like conductors, and some of the stops everybody made were to the tunes of "Chicago," "Nashville" and "Everything's Up to Date in Kansas City."

Dressed as a hobo, she did, "Back

## review

in Your Own Backyard" and "Saturday Night in Toledo, Ohio, Is Like Being Nowhere at All."

In another number, "One Step," Gaynor was in a short red sequined dress and the guys in red tuxes. For "The Heat Is On," she wore a glittering white dress and the chorus included three guys on stilts singing "Dancing with a Big Boy."

The second half of the program was dedicated to "The King of Swing, Benny Goodman." She wiggled when she walked, dressed in a '40s purple dress with peplum, as "Mellow Mitzi Marlowe" singing a medley of tunes from that era, with the "Mellowaires." The number ended with a swinging rendition of "Mr. Five by Five."

She wore a strapless gown and long white gloves to do "Blues in the Night," and then three guys nearly

stole the show, getting thunderous applause, after they did a rhythmic medley of tunes, dressed as the Andrews Sisters.

A brief bit followed as Carmen Miranda, with Gaynor in towering headdress, singing "Chick-a-Boom Chick," and then doing some comic aspects whisking off her hat and trudging off the stage.

She stood still for a while only when she did a medley of songs as a nightclub singer accompanied by a pianist. In a black and white gown, she sang, "I Thought About You," "The Very Thought of You," "I'm Beginning to See the Light," "Everything Happens to Me" and "For All We Know."

Her closing number was in a long white gown with winged sleeves ("I look like Imelda Marcos"), singing "I Can't Smile Without You."

# Sunday brunch atmosphere is relaxed

By Ethel Simmons  
staff writer

If you like Sunday brunch to be unhurried and unhassled, the newly revived offering at the Hotel Pontchartrain's Top of the Pontch may be what you seek.

The just-renovated restaurant is the attractive setting for a brunch that features not only some 30 dishes on the menu but one of Detroit's most spectacular skyline views, along with the cool strains of Larry Nozero's jazz.

Cornell Mohoreanu, new food and beverage director at the Pontch, re-established the Sunday brunch because he believes the room and view deserve to be admired. The soft, pink-toned decor, with touches of blue, provides a pleasant backdrop for relaxing.

Saxophone star Nozero, who is from Farmington, is on the bandstand during the hours of 11:30 a.m. to 3:30 p.m. (brunch runs until 4). The performers are called Larry Nozero and Friends because the musicians accompanying him are a changing group of jazz artists.

## table talk

MOHOREANU SAID the Top of the Pontch seats 120 diners at once and will accommodate up to 400-450 brunchgoers during the entire day. But the director doesn't want the room to get overcrowded; the serene atmosphere is part of the ambience.

Brunch specials change weekly, which is one way of encouraging diners to return regularly. "This week everyone is raving about the pate. Last week it was the shrimp," Mohoreanu said. Hot dishes may include prime rib one week, roast beef another.

On the cold buffet, one recent week, were stuffed pears and peaches, herring in sour cream, marinated mushrooms, and pasta and bay shrimp salad, to name just a few.

Gleaming copper chafing dishes held such hot-buffet specialties as

eggs benedict, smoked tarragon chicken, cheese blintzes with blueberry sauce, broiled fish with creole sauce, broccoli polonaise and little parsley-boiled redskin potatoes.

Deserts included traditional favorites: cheesecake, apple pie, cherry pie, fresh strawberries and romanoff sauce, and chocolate and vanilla mousse.

EVERYTHING TRIED on the brunch was very tasty. In addition to the good food, mention must be made of the impeccable service by

the waiters (in this instance Leon) that is a consistent pleasure at the Top of the Pontch.

Rumanian-born Mohoreanu, who arrived at the hotel six weeks ago from Washington's Ritz-Carlton, also hopes to bring back evening dining to the Top of the Pontch.

The brunch with jazz is \$14.95 for adults (including a complimentary glass of champagne), half-price for children under 8. Three hours of free valet parking is available, too.

For reservations call 965-0200, Ext. 3767 or 3768.

DINING AND ENTERTAINMENT GUIDE  
**ON THE TOWN**

**BRONZE WHEEL**  
ANNIVERSARY SPECIAL  
\$100 OFF Regular Dinners  
WITH THIS AD  
Expires 6-29-86  
\*Specials excluded  
Try Us, We'll Surprise You!  
Also, try our elegant banquet room for 20 to 400 - Showers, Weddings, Retirements, ALL OCCASIONS!  
TUES.-SUN. BUSINESSMEN'S LUNCHEONS & DINNERS (CLOSED MONDAY)  
27225 W. Warren (1/2 blk. E. of Inkster) 278-9115

Since 1937  
**Smiley Brothers**  
BECHSTEIN...THE WORLD'S MOST HONORED PIANO  
"Bechstein is a triumph of touch and tone."  
ARTUR SCHNABEL  
Birmingham - 647-1177 - Detroit - 875-7100

**REAL LIFE DAY CAMP**  
AND FARM  
FOR BOYS & GIRLS 6-14  
HUGE, 3 STORY BARN FOR ALL AROUND ACTIVITIES  
60 ACRES of rugged wooded land. Limited transportation available. Reasonable rates.  
Your choice from 2 to 10 weeks  
June 16 to August 29  
Jim Fraser, Director  
M.S. in Physical Education, U of M  
HDQS: 26300 Ford Rd., Dearborn Hgts.  
FARM: 48700 Geddes Rd., Canton Phone: 563-3690

**Your kitchen is on fire.**  
What would you do if it were a grease fire? An electrical fire? Red Cross will teach you what you need to know about fire safety. Call us. We'll help. Will you?  
American Red Cross+

**BONE-YARD BAR-B**  
COCKTAILS IN LIVONIA LUNCH SPECIALS Everyday Until 4:00  
OPEN ALL HOLIDAYS  
COUPON - Also good for Carry Out Only One Item, Please!  
SLAB OF RIBS \$2.00 OFF FOR 2  
BAR-B-Q CHICKEN \$1.50 OFF FOR 2  
2 Cole Slaws, 2 Cottage Fries and 2 Garlic Bread (Midweek) 427-8500  
831-7000  
HOURS: SUN. THRU THURS. 11 a.m. to 10:00 p.m. and SAT. 11 a.m. to 2 a.m. CALL AHEAD - it will be waiting for you! \$15 MINIMUM CHARGE

**BIG DEAL**  
**SAVE BIG**

**1/2 OFF DEVELOPING & PRINTING** 522  
on disc, 110, 126 or 35mm color print roll of film (full frame, C-41 process only). One roll per coupon. Multiple sets of prints are 1/2 off regular print price, at time of developing. Excludes use of other coupons.  
Offer good through 6-28-86.  
COUPON MUST ACCOMPANY ORDER.

**KODAK FILM 1.97**  
SALE COST+7%  
110-12 EXPOSURE VR200  
Plus huge savings on other film sizes. Hurry! Sale Ends Saturday.

**11x14 COLOR ENLARGEMENTS**  
Now only 595 (reg. 12.50)  
From your 35mm negative.  
Coupon must accompany order.  
Offer good through 6-28-86.  
Over 5 stores in the Detroit area alone. For nearest Fox Photo store, please check your telephone directory business white pages or call 453-8410.

**TOMORROW OR FREE**  
BUY A "PREFERRED CUSTOMER" Discount Club Card  
With this card you SAVE on...  
On disc, 110, 126 or 35mm color print film (full frame, C-41 process only). Good Monday through Thursday. Holidays excluded. Ask for details.  
FOX PHOTO  
The 35mm Specialist.

it's worth hunting for...  
**STEAK and SHRIMP \$9.95**  
Mon., June 23 thru Thurs., June 26  
Bob's Steakery  
Open at 11:00 a.m. Mon. thru Sat.  
211 N. NEWBURGH WESTLAND 723-7788



Daryl Hannah wisely pouts, in her portrayal of the client whose case Winger is handling.



**SUMMER  
Specials**

**SUMMER  
Specials**

**SUMMER  
Specials**

**SUMMER  
Specials**

**HOLIDAY  
ENTERTAINING**

**\$499**



Finkel Freeport 42" wicker or glass table, 4 stack cushion chairs — Retail \$640

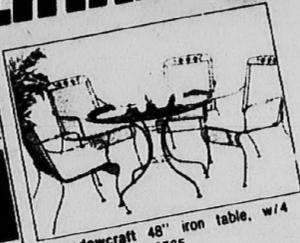

Meadowcraft 48" iron table, w/4 chairs — Retail \$765

**\$699**

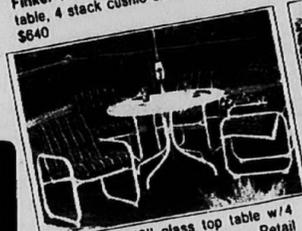

Samsonite 48" glass top table w/4 cushion body glove chairs — Retail \$1167



Samsonite 42" wicker table, 4 Z frame chairs — Retail \$930

**\$899**



Tropitone Jai Alai 48" acrylic table w/4 cushion chairs — Retail \$1196



Winston Summer winds 5 piece group — Retail \$1309

Now thru July 6  
all outdoor and indoor  
casual furniture specially priced  
for your holiday entertaining.

**Ray Mar  
casuals**

**CASUAL FURNISHINGS FOR INDOORS & OUT**  
Mon., Thurs., Fri. 10 a.m. - 8 p.m.; Tues., Wed., Sat. 10 a.m. - 5 p.m.; Sun. 12:00 p.m. - 4:00 p.m.  
35834 Van Dyke Sterling Heights Brentwood Plaza Between 16 & 16 1/2 mile  
**FREE DELIVERY**  
979-5500

*Lose all the  
weight you want!*

**FOR ONLY  
\$99\***

Losing weight  
will NEVER  
cost less!  
**FINAL WEEK**



Before  
I've tried so many diets, but failed. Physicians WEIGHT LOSS Centers really worked! The staff was very supportive. My husband and family are so proud!  
Carol Botch

\*NOT VALID WITH ANY OTHER OFFER. MEDICAL FEES AND PRODUCTS EXCLUDED. Expiration date: June 27, 1986.



**Physicians  
WEIGHT LOSS  
Centers**

ULTRA LOSS DIET SYSTEMS

**FARMINGTON HILLS**  
28501 Orchard Lake Rd.  
N. of 12 Mile  
553-6360

**LIVONIA**  
37572 Professional Center Dr.  
Near Newburgh & 5 Mile  
464-4844

**TROY**  
909 W. Maple  
E. of Crooks  
435-2060



**Ziebart**  
CAR IMPROVEMENT SPECIALISTS

**A cool price to  
beat the heat**



**Air Conditioning Service**

- Fast, efficient service from Ziebart professionals
- Electronic inspection for leaks
- Freon recharge
- Check for maximum cooling efficiency

FROM **\$19<sup>95</sup>**

**\$100 OFF**  
Ziebart's **NEW CAR**  
Protection Package

- Rust Protection
- Paint Protection
- Fabric Protection

**\$100 OFF**  
Ziebart's **USED CAR**  
Protection Package

- Rust Eliminator
- Rust Protection
- Sound Deadener

**Bug Deflector**

- Protects front-end from bugs and stones
- Keeps windshield clear
- Impact-resistant acrylic
- Choice of colors
- Fits most pick-ups or vans, domestic and imports

NOW  
FROM **\$39**  
Reg. \$59



**Running Boards \$20 OFF**

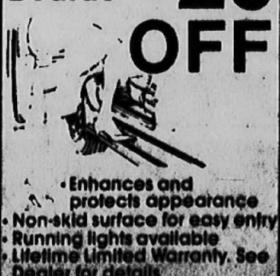

- Enhances and protects appearance
- Non-skid surface for easy entry
- Running lights available
- Lifetime Limited Warranty. See Dealer for details

**Sun-Roofs**

Reg. 239.00

**\$179**

- Flush mounted, air and water tight
- Professional installation

**Be Car Smart. Save at Ziebart.**

**FARMINGTON HILLS**  
32418 W. 8 MILE RD.  
478-1552

**TROY**  
1252 E. MAPLE RD.  
588-8620

**WESTLAND**  
27530 W. WARREN  
425-5170

OFFER EXPIRES 7/30/86

**NOW...**

**ENJOY THE NEW  
YOU THIS  
SUMMER!**

**The Plastic Surgeons Guild Offers...**

- No Hospital Costs
- No Overnight Stay
- Affordable Fees
- Years of Outpatient Surgical Experience

**Call for FREE consultation**

Back to work or to the beach sooner than you think!

Just some of our procedures...

- Female Breast Enlargement • Male Breast Reduction
- Nose & Eyelid Correction • Face & Neck Lift • Suction Fat Removal

**(313) 828-7777**

**THE PLASTIC  
SURGEONS GUILD**

5897 JOHN R • TROY

All Financing — Free Brochure

# Opinion

Emory Daniels editor / 459-2700  
Susan Roelck assistant managing editor

489 S. Main/Plymouth, MI 48170

Philip Power chairman of the board  
Richard Aginian president  
Dick Isham general manager  
Steve Barnaby managing editor  
Fred Wright circulation director

10A(P)

O&E Monday, June 23, 1986

## Eddie talked himself out of Pulitzer Prize

(Part 2)

When Eddie Edgar joined the Free Press as sportswriter in 1924, he had trouble getting his first story past sports editor Harry Bullion. After Bullion had blue-penciled the article several times, Eddie asked him what was wrong.

"We don't allow colloquialisms at the Free Press," Bullion told him.

"Unfortunately," Eddie told me, "I didn't know what a colloquialism was. I saw one of the older writers by the water jug. He seemed to have a sympathetic face so I told him my problem."

"Go back and take out all of the slang words, kid. He'll take it then." Eddie did, and had no trouble with Bullion from then on.

Eddie spent almost 25 years at the Free Press, part of them as sports editor.

He came to meet and interview most of the great sports figures of the 20s and 30s. He had almost total recall of his experiences with Ty Cobb, Babe Ruth, Lou Gehrig, Joe DiMaggio, Mickey Cochrane, Jack Dempsey, Gene Tunney, Joe Louis, Gar Wood, Wilbur Shaw, Gus Dorais and many others.

out any hesitation: "Being with Joe throughout his career."

He remembered that it was 1932 when a tall black youth walked into his office and asked where he could sign up for the Golden Gloves. Eddie virtually was Joe's amateur manager until 1934, when John Roxborough became his professional manager. Eddie told me the most exciting moment he ever had in sports was on June 22, 1937, in Comiskey Park in Chicago, when the referee raised Louis' hand as heavyweight champion of the world.

"You can't compare generations," said Eddie, "but Joe had the fastest hands I ever saw. He was the smoothest fighter and the hardest puncher I ever saw."

**EDDIE LOVED** the newspaper business but conceded that he had a few bad breaks in the 67 years since he wrote his first story. There was, for example, the time when he



past and present

Sam Hudson

talked himself out of a share of the Pulitzer Prize. That happened in 1931, and it was of his own doing.

Malcom Bingay, managing editor of the Free Press, had assembled a group of reporters to cover an American Legion parade in Detroit. Eddie was drafted from the sports department to be a member of the team that Bingay sent in various directions to cover the story. Eddie wrote two columns of the composite article.

On the day the story was to appear, Eddie heard Bingay and some of his assistants discussing the mat-

ter was writing of the world record-breaking feats of motorboat racer Gar Wood.

**ONE DAY** in 1933 when Wood had just set a world's water speed record at Algonac, Eddie was dismayed because the timing of the event was wrong for the Free Press.

"What can I write about at 4 p.m.," he complained to Wood. "Harry La Duc of the 'News' has me beat already. I know — tell me about your emotions just as you broke the record."

Gar Wood found a helmet and goggles, put them on Eddie and told him to jump into the boat, Miss America. As they skimmed the water, Eddie told me he kept watching the needle go up and up until it hit 124.58 m.p.h., the speed that broke the record.

"Now," said Gar Wood, "write

about your own emotions. Whatever you felt, I felt."

Two years later, Eddie rode at 130 m.p.h. with Wilbur Shaw at the Indianapolis Speedway, "just to get the feel of it." He said he always tried to get involved in the action of whatever sport he was covering. "I had the gloves on with Dempsey and with Joe Louis," he said.

One day, Eddie was on the golf practice green at Oakland Hills with Walter Hagen and Al Watrous. Although he often wrote about golf, Eddie rarely played the game and admitted he was no good at it.

On this day, however, while the two were watching, he sank a long, curling putt. Eddie turned to Hagen and Watrous, who stared in disbelief, and said: "Don't tell me you get paid for doing this?"

(To be continued)

### from our readers

Letters must be original copies and contain the signature and address of the sender. Limit letters to 300 words.

### Sheldon, Lilley eyesores grow

To the editor:

Have you driven down Sheldon Road or Lilley Road lately? I realize that privacy is needed to houses bordering the main thoroughfares, but something should and must be done to unify these privacy fences.

In Ordinance 103, effective 11-6-80, Sec. 6.0, Item g, it is stated that all fences must be maintained in good structural condition at all times. All fences shall be kept neatly painted, stained, sealed or preserved and such treatments shall be of a same contiguous color, stain or treatment.

A definition in the dictionary of

contiguous means adjoining, or next to.

The building department failed to include what this same contiguous color is. They also have failed to follow up to see that the fencing ordinances are enforced. One new comment that they should add to their ordinance is to stipulate that all smooth "outsides" of fences should be installed to face the street.

Now I know why many other communities have a "no-fence" ordinance. They must have driven down one of Canton's main roads.

To improve the situation, which has completely gotten out of hand, I propose that we speak up as a community and have these ordinances enforced. That would mean all fences are to be repaired and that a uniform paint or stain be used throughout the whole area. Paints and stains are available in the same color. This would eliminate our checkerboard

effect of multicolored fences.

If you agree with my views, please call the building department at 397-1005 and express that you want them to enforce the ordinance.

Maybe it's not too late to "Help Beautify Canton" and make our community one to be proud of.

M.L. Kokoszka,  
Canton

### River rescue huge success

To the editor:

Rouge Rescue '86 was an outstanding success. On Saturday, June 7, 15 sites along the 126 mile Rouge River were cleaned. The cleanup and the days' activi-

ties were coordinated through individual towns, the governments of Wayne, Oakland, and Washtenaw County, SEMCOG, the River Rouge Watershed Council, Friends of The Rouge, Ford Division, WJBK-TV Channel 2, The Detroit News, Gannett Outdoor, and WRIF-Radio.

Local DPW's hauled trash and debris from the river the week prior to June 7. Then more than 2,300 volunteers hauled truckloads of trash and debris from the river banks and surrounding areas to trucks and dumpsters.

George Palmiter, a nationally recognized river-restoration expert, removed a large logjam along the river in the city of

Wayne, enabling the water to once again run freely.

We were pleasantly surprised with such a large turn-out; getting dirty and wet did not deter the volunteers. Rouge Rescue '86 was a huge success and we would like to thank everyone who came out and all the ambitious people who helped rescue a river.

The cleaning of the river will be continued throughout the summer by paid part-time personnel, providing summer jobs for the area's youth. And Rouge Rescue will be an annual event.

For a clean river, thanks.  
Bruce Monson  
River Rouge  
Watershed Council



**BULIMIA?**  
If you are a binge eater you may qualify for a study at Lafayette Clinic with W.S.U. Researchers. Confidentially maintained treatment is provided after the study. This is NOT a weight loss program. Intake Team.

**LAFAYETTE CLINIC**  
256-9569  
Mon-Fri, 8 A.M.-4 P.M.

250,000 Michigan  
**BANK TO WIN!**

**Michigan National Banks**  
The smart money is with us.

**FACTORY BUYOUT**

**Bass 12.99**  
women's sandals

**SAVE 1/2 AND MORE**

FANTASTIC SAVINGS ON SANDALS FROM BASS® THE QUALITY SHOEMAKER  
current season's styles • sold elsewhere for \$30  
genuine leather uppers • white, cinnamon, fuchsia or tan

**SAVE AN ADDITIONAL 25%** men's and women's clearance shoes  
LOOK FOR THE SPECIAL TAGS and take an additional 25% off our already reduced clearance shoes, identified by even dollar endings.

**El Bee SHOES**  
FAMOUS BRANDS FOR LESS

Shop only 10 a.m. to 9 p.m. Sunday 12 p.m. to 5:30 p.m.

WESTLAND CROSSINGS SHOPPING CENTER  
(Across from Westland Mall)

WE ACCEPT MASTERCARD, VISA, AMERICAN EXPRESS, AND ELDER-BERMAN CHARGE

<p><b>HOYT WATER HEATER</b> 40 GALLON</p> <p>SAVE \$50<sup>00</sup></p> <p><b>\$285<sup>01</sup></b> INSTALLED Reg. \$335.01</p> <p>STANDARD GAS CHANGE OUT. 10 YEAR LIMITED WARRANTY ENERGY SAVER</p>	<p><b>DON'T GET IN OVER YOUR HEAD.</b></p> <p><b>RELAX AND ENJOY LET BERGSTROM'S DO IT RIGHT!!</b></p>	<p><b>ELJER</b></p> <p>NEW EMBLEM WATER SAVER TOILET WITH SEAT</p> <p>SAVE \$40<sup>00</sup></p> <p><b>\$177<sup>85</sup></b> INSTALLED</p> <p>Regular Price \$217.85</p> <p>ELJER TOILET WITH SEAT \$116.85 MISC. MAT. 16.00 LABOR 50.00 TAX 5.00 <b>\$177.85</b></p>
<p><b>Valley</b></p> <p>SINGLE HANDLE KITCHEN FAUCET</p> <p>SAVE \$95<sup>00</sup></p> <p><b>\$178<sup>07</sup></b> INSTALLED</p> <p>Regular Price \$273.07</p> <p>Faucet \$140.00 Misc. Mat. 10.00 Labor 28.00 Tax 10.00 <b>\$178.00</b></p>	<p><b>BERGSTROM'S</b></p> <p>JUNE INSTALLATION SPECIALS</p> <p>TWO SALES AND SERVICE CENTERS TO SERVE YOU</p> <p>REDFORD 28425 W. 5 MILE RD. 285-2100 HOURS: MON-FRI 9-7 SAT 10-6 SUN 12-4</p> <p>FARMINGTON HILLS 2824 GARDEN LAKE RD. 383-0225 HOURS: MON-FRI 9-6 SAT 10-6 SUN CLOSED</p>	<p><b>Valleycrest</b></p> <p>DECORATIVE TUB AND SHOWER FAUCET 3 VALVE</p> <p>SAVE \$40<sup>00</sup></p> <p><b>\$178<sup>07</sup></b> INSTALLED</p> <p>Regular Price \$218.07</p> <p>Faucet \$140.00 Misc. Mat. 10.00 Labor 28.00 Tax 10.00 <b>\$178.00</b></p>

**+GIVE LIFE**

**SUMMER  
Specials**

**SUMMER  
Specials**

**SUMMER  
Specials**

**SUMMER  
Specials**

Objective: Quality Delta industrial power tools at an affordable price.

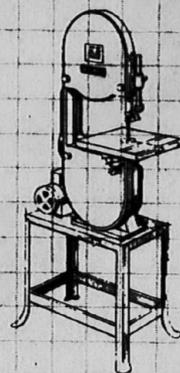

Model #28-243F  
Delta Band Saw  
Complete with #82-142  
1/2 H.P. motor

List \$746<sup>00</sup> Sale \$595<sup>00</sup>

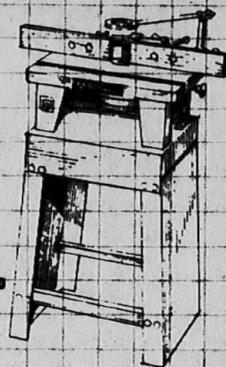

Model #43-122  
Delta Wood Shaper  
Ideal for moldings

List \$707<sup>00</sup> Sale \$575<sup>00</sup>

Price includes FREE  
Carbide Shaper Cutter.

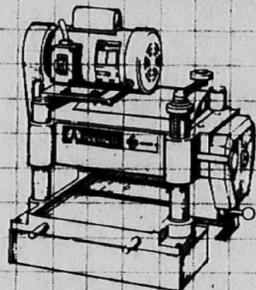

Model #22-651  
Delta RC-33 Planer  
13" x 15.9" capacity,  
2 H.P. motor

List \$1729<sup>00</sup> Sale \$1129<sup>00</sup>



Model #33-150  
Delta Saw Buck  
The complete Tool for framing  
and trim.

List \$707<sup>00</sup> Sale \$575<sup>00</sup>

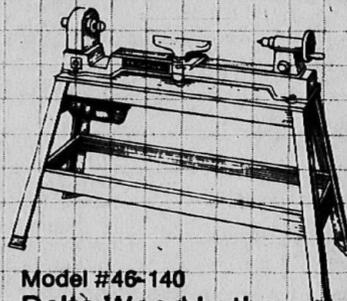

Model #46-140  
Delta Wood Lathe  
Complete with #82-142 1/2 H.P. motor,  
11" swing capacity 15" over gap.

List \$573<sup>00</sup> Sale \$469<sup>00</sup>



**Glenn Wing**  
POWER TOOLS

Sale Ends July 31

1437 South Woodward Avenue  
(North of 14 Mile Road)  
Birmingham, Michigan 48011  
(313) 644-5440

COMPLETE SELECTION OF WOODWORKING TOOLS AND ACCESSORIES

**PARENTS!**

LOOKING FOR A REWARDING EXPERIENCE  
FOR YOUR CHILDREN

THIS SUMMER?  
Children 6-12 years

**O.C.C. SUMMER DAY CAMP**

SESSION I JULY 7-25  
DEADLINE JUNE 25

SESSION II AUGUST 4-22  
DEADLINE JULY 21

TAKE ADVANTAGE OF  
O.C.C. ORCHARD RIDGE'S OUTSTANDING FACILITIES  
THE FINEST IN PROFESSIONAL INSTRUCTION  
SUPERVISED EXTENDED HOURS ACTIVITIES  
FOR LESS THAN \$80.00 PER WEEK

**6-7 YEAR OLDS**

9:00-10:30 a.m.	12:30-2:00 p.m.
Beginning Jazz OZ 001	Art Potpourri OZ 011
Creative Expression OZ 002	Beginning Ballet OZ 012
In Words & Play OZ 003	Beginning Jazz OZ 013
Mime & Clowing OZ 004	

10:30-12:00 noon	2:00-3:30 p.m.
Beginning Tap OZ 005	Beginning Tap OZ 017
Creative Cooking OZ 006	Creative Movement (Dance) OZ 018
Tumbling OZ 010	Mime & Clowing OZ 020

**8-9 YEARS OLD**

9:00-10:30 a.m.	12:30-2:00 p.m.
Beginning Jazz OZ 021	BASIC I OZ 031
Karate OZ 022	Beginning Ballet OZ 032
Pottery OZ 023	Beginning Jazz OZ 033
Theatre-Beginners OZ 024	Cartooning OZ 034
Tumbling OZ 025	Karate OZ 035
	Yerins OZ 036

10:30-12:00 noon	2:00-3:30 p.m.
Beginning Tap OZ 026	Art Potpourri OZ 040
Cartooning OZ 027	BASIC II OZ 041
Magic OZ 028	Beginning Tap OZ 042
Swimming OZ 030	Fun With Math OZ 043
	Volleyball OZ 044

OAKLAND COMMUNITY COLLEGE  
27055 ORCHARD LAKE ROAD

ORCHARD RIDGE CAMPUS  
FARMINGTON HILLS, MI 48018

**10 - 12 YEAR OLDS**

9:00-10:30 a.m.	12:30-2:00 p.m.
Beginning Jazz OZ 045	BASIC II OZ 056
Karate OZ 046	Beginning Ballet OZ 057
Mime OZ 047	Beginning Jazz OZ 058
Photography OZ 048	Cartooning OZ 059
Pottery OZ 049	Dogfighting OZ 060
	Karate OZ 061
	Tennis OZ 062

10:30 - 12:00 noon	2:00-3:30 p.m.
Beginning Tap OZ 050	BASIC III OZ 064
Build A Robot OZ 051	Beginning Tap OZ 065
Cartooning OZ 052	Boats OZ 066
Magic OZ 053	Spreading OZ 070
Swimming OZ 055	Theatre Workshop OZ 071
	Volleyball OZ 072

TUITION  
For each three-week session:  
FULL-TIME \$236.00  
4 classes per day (Monday-Friday) 9:00 a.m. to 3:30 p.m.  
HALF-TIME \$118.00  
2 classes per day (Monday-Friday) 9:00 a.m. to 3:30 p.m.

One registration form per student please Date \_\_\_\_\_

Student's Social Security Number (if available) \_\_\_\_\_

Student's Name Last First Middle \_\_\_\_\_

Student's Address Number Street Apt. \_\_\_\_\_

City State Zip \_\_\_\_\_

Father's Business Phone \_\_\_\_\_ Mother's Business Phone \_\_\_\_\_

Home Phone \_\_\_\_\_

COURSE SELECTIONS: SESSION I SESSION II

9:00-10:30 a.m. OZ \_\_\_\_\_ Course Name \_\_\_\_\_

10:30-12 Noon OZ \_\_\_\_\_ Course Name \_\_\_\_\_

12:00-2:00 p.m. OZ \_\_\_\_\_ LUNCH (Student's Provided) \_\_\_\_\_

12:30-2:00 p.m. OZ \_\_\_\_\_ Course Name \_\_\_\_\_

2:00-3:30 p.m. OZ \_\_\_\_\_ Course Name \_\_\_\_\_

ALTERNATE COURSE SELECTIONS: \_\_\_\_\_

9:00-10:30 a.m. OZ \_\_\_\_\_ Course Name \_\_\_\_\_

10:30-12 Noon OZ \_\_\_\_\_ Course Name \_\_\_\_\_

12:30-2:00 p.m. OZ \_\_\_\_\_ Course Name \_\_\_\_\_

2:00-3:30 p.m. OZ \_\_\_\_\_ Course Name \_\_\_\_\_

PLEASE MAKE CHECK PAYABLE TO OAKLAND COMMUNITY COLLEGE

Please Cut Out & Mail to: OAKLAND COMMUNITY COLLEGE  
Admissions Office, Orchard Ridge Campus  
Farmington Hills, MI 48018

If you need further information, please call 471-7667 or 471-7668 AND ASK FOR RAJLA

SUMMER COURSES AVAILABLE FOR TEENS 13-18 YRS. TOO!

**GRAND  
OPENING**

Tuesday, June 24th

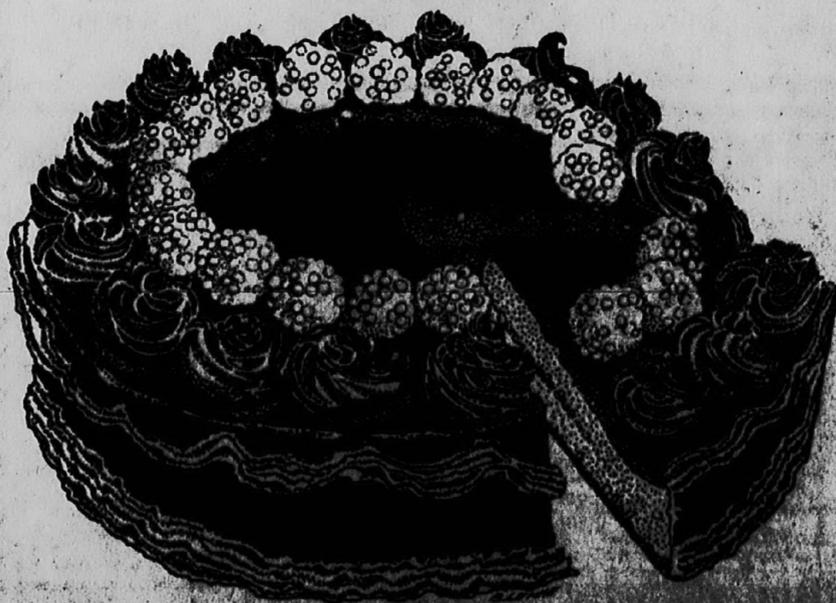

Come and enjoy the finest one of a kind  
Tortes, Truffles and Petite Pastries available.  
Made from all natural ingredients.  
Fresh fruits, nuts and chocolates.

Seating available for coffee, croissants  
or pastries. Dessert catering also available.

Hours: Monday-Saturday, 8am-7pm  
Located in the Laurel Commons Shopping Center  
37210 W. 6 Mile Livonia, MI 48152 • 464-8170



**A COOL PRICE TO  
BEAT THE HEAT  
- AIR CONDITIONING SERVICE -**

\*FAST EFFICIENT SERVICE  
FROM CAP'S PROFESSIONALS

\*ELECTRONIC INSPECTION  
FOR LEAKS

\*FREON ON RECHARGE\*

\*CHECK FOR MAXIMUM  
COOLING EFFICIENCY

\*Plus number of lbs. used

**\$19<sup>95</sup>**  
FROM LABOR

35 Years Experience  
**CAP'S**  
HEATING  
& COOLING

Sales  
Service  
Installation

ALL ENERGY  
EFFICIENT  
FURNACES  
AND  
EQUIPMENT

"WE'RE SERVICE SPECIALISTS"

WE SERVICE ALL BRANDS "WE BEAT THE BIG BOYS"  
WARRANTY • LEASE PARTS AVAILABLE FOR ALL MAKES  
24 HOUR SERVICE WE FIX WHAT OTHERS CAN'T  
VIOLATIONS CORRECTED  
POWER HUMIDIFIER SALES & SERVICE

LIVONIA - NORTHWEST CORNER  
427-5...

# ALL AMERICAN SALE



**The Village Golf Shoppe**  
Special Grand Opening Sale

ALL PRO LINES AVAILABLE • LADIES/MENS ATTIRE  
453-8830  
620 SPRING ST., PLYMOUTH

**sunny j's**  
lingerie & leisure wear

470 Forest Plymouth (313) 453-8584

**20% OFF ALL**

SWIMWEAR  
"SUMMER" LEISUREWEAR  
COTTON LINGERIE  
JUNE 23 - JULY 4

Bra Sizes 32A-46DD Always Personalized Bra Fitting Lingerie Sizes Petite to XL

He believes that in America almost anything is possible if only one has the courage to dream.

"A Young Man's Dream" by Norman Rockwell

Norman Rockwell Salutes the optimistic spirit of America in a limited edition collector plate.

Available Now, An Heirloom Tomorrow **\$22.90**

"A Young Girl's Dream" still available at \$19.90

**Georgia's Gift Gallery**  
A Bradford Exchange Information Center  
Collector Plates & Limited Editions  
615 N. Mill St. (Lilly Rd.) • Old Village Plymouth • 453-7733  
Phone Orders Welcome. Free Delivery.  
Hours: Mon.-Tues.-Wed. 10-7, Thurs.-Fri. 10-8, Sat. 10-4, Sun. 12-5

*Mofelder's Salon*

37657 5 MILE AT NEWBURGH LIVONIA • 464-1661  
33223 W. 7 MILE LIVONIA • 476-1372

**7 MILE SPECIALS ONLY**

**TANNING SPECIAL**  
FREE VISIT WITH ANY TANNING PACKAGE PURCHASED THRU 7-31-86

**20% OFF ANY HAIR SERVICE WITH Patti, Christina, Annie.**  
Introductory Offer Thru 7-31-86

**Ribbons**

**1/2 OFF SALE**

JUNE 24, 10-6 • JUNE 25, 10-6

**BASKETS 'N' BOWS**

470 Forest • 455-8888

**NOW OPEN FOR BUSINESS!!!**

**BOYER'S MEATS & DELI**  
USDA Choice Black Angus Beef

**HAMBURGER** made from Ground Round  
5 lbs. or more **1.39 lb.**  
Expires 6/30/86

**20% OFF ALL FRESH KOWALSKI LUNCH MEAT**

**WINTERS**  
Natural Casing Wieners \$1.89 lb.  
Skinless Wieners \$1.59 lb.  
Expires 6-30-86 While Supply Lasts

29896 FORD RD. 525-2680  
Inside Dash Party Store

**Friendly Merri Bowl Lanes**  
30950 5 Mile (Just E. of Merriman) Livonia • 427-2900

**HEY MOM...WANT TO KEEP YOUR CHILD FROM BOREDOM THIS SUMMER?**

Have them join a Youth League!  
WED. 9:30 am 6-25-86 to 8-13-86  
THURS. 12:30 pm 6-26-86 to 8-14-86

For 8 weeks \$2<sup>75</sup> includes:  
• T-shirt • Hot Dogs & Coke  
• 2 Games • Coaching

**TEN PIN TODDLERS**  
THURS. 12:30 pm AGES 3-6  
\$1.00 BOWLING, COOKIES & JUICE

**Complete Line of the Freshest Fruits and Vegetables**

Ice Cold **WATERMELON**  
Whole \$3<sup>95</sup> and up

- Strawberries
- Fresh Baked Bread
- Dairy Products
- Fresh Cut Flowers

**KENTUCKY Vine Ripened TOMATOES**

**CLYDE SMITH & SONS**  
FARM MARKET & GREENHOUSES  
8000 NEWBURGH 425-1434  
Hours: Mon.-Sat. 9-9; Sun. 9-6

**GRAND OPENING**  
SATURDAY, JUNE 28 9:00 A.M. - 7:00 P.M.

**IN OUR OWN HOLIDAY PLAZA STORE**

Come in and register to win our 2-Lb. Cannisters containing any of our five delicious flavors. No purchase necessary. Drawing June 28th.  
**- 10 Winners in All -**

**OUR CHIPS ARE MADE FRESH DAILY IN OUR HOLIDAY PLAZA STORE**  
CHOOSE:  
Regular • B-B-Q • Sour Cream & Onion  
Vinegar & Salt • No Salt

**COUPON**  
20% OFF \$2<sup>99</sup> - Our 16 Oz. Bag  
15% OFF \$1<sup>79</sup> - Our 11 Oz. Bag  
Coupon Good thru 6-28-86

**DOWNEY'S POTATO CHIPS**  
Prepared fresh daily

**HOLIDAY PLAZA**  
8509 N. WAYNE ROAD WESTLAND 425-8986  
HOURS: Mon.-Sat. 6:00-7:00 P.M.

**SUMMER CARPET CLEANING SPECIAL**  
Two Rooms and Hall **\$34.00**

EACH ADDITIONAL ROOM \$12.50  
CARPET AND FURNITURE CLEANING  
COMMERCIAL TRUCK MOUNTED UNITS  
3M SCOTCHGARD

**PALOMBO FLAGG**  
Carpet Cleaning  
19885 Beech Daly • Redford, MI 48240  
Phone: 313 / 584-8775  
"We Get All the Dirt Others Leave Behind"

**THE FURNITURE REFINISHING PLACE**  
Specializing in in-home Restoration.  
Kitchen Cabinet Refinishing  
**-FREE ESTIMATES-**

We can restore old pieces to look new again. Our prices are surprisingly affordable.

**COUPON**  
**10% OFF\***  
ANY REFINISHING JOB  
EXPIRES 8-23-86  
CALL 537-2286  
18277 WOODBINE DETROIT

**J & D Fashion Cleaners**  
SHIRT LAUNDRY

**3 FOR 2 SPECIAL**

BRING IN ANY 3 ITEMS, PAY FOR THE CLEANING ON 2 AND WE WILL CLEAN THE 3rd FOR FREE!  
(\*Items of same or lesser cost for free)

**GOOD THRU 7-26-86**

**QUALITY AND FAST SERVICE**  
"Have Your Morning Coffee On Us!"

427-0100 SIX MILE AND INKSTER • LIVONIA  
Mon.-Fri. 7 a.m.-7 p.m.; Sat. 9 a.m.-4 p.m.

**COMPANIONS LTD**  
In Our Mobile Salon  
at Your Home for Your Convenience  
Distinctive Individualized Pet Trims

**\$2<sup>00</sup> Off**  
Complete Grooming  
With This Ad  
Coupon Expires 8-31-86

**WE COME TO YOU**  
**425-4017**

**INVENTORY CLEARANCE ON ALL FLOOR SAMPLES SAVINGS**

UP TO **50% OFF AND MORE!**

Quality - Value - Price  
427-3080

**Chris Furniture**  
Furniture  
22225 Plymouth Rd., Livonia

Hours: Mon., Fri. 9:30-9:00  
Tues., Wed., Thurs., Sat. 9:30-6:00; Sunday 12-5

**PERM ADULT HAIRSTYLE**  
**\$35** Reg. \$50.00 With Coupon Expires 7-7-86

**\$5<sup>00</sup> OFF** Reg. \$16 Men Reg. \$18 Women With Coupon Expires 7-7-86

**Yankee Clipper**  
Plymouth 426-6666 Northville 346-6666 Redford Township 897-2982

**PREVENTIVE HEALTH CARE FOR YOUR OLDER DOG**

Along with regular exercise and checkups, eating the right foods is an important part of a preventive health care program. That's why there's Science Diet® Canine Senior.

**CANINE SENIOR®**

- Scientifically formulated to help dogs stay active and live longer.
- Recommended for most dogs age 5 and older.
- Provides greater amounts of essential vitamins and fiber.
- Properly restricts protein, salt and minerals.
- Helps to compensate for conditions often present in older dogs, such as reduced function of the heart, kidneys and digestive system.
- Available in both dry and canned forms. Come by and let us show you why Canine Senior is the best food you can feed your older dog.

**Chaps Feed Store**  
29216 Five Mile (Just E. of Middlebelt) Livonia Mon.-Sat. 9-7 **421-4700**

**SCIENCE DIET.**  
Because preventive health care starts with proper nutrition.

# Shopping Cart

Monday, June 23, 1986 O&E

★ 18

## Great Summer Desserts - EXCITING New Flavors

Chocolate, vanilla and strawberry move over, you're being upstaged by more exotic flavors. Here's a fresh repertoire of ice cream recipes based on the tangy flavor of cranberries and grapefruit, to eat in a cone or serve as desserts. Enjoy a touch of the Caribbean with pina colada or banana daiquiri ice cream. Buy vanilla ice cream to give you a head start on cranberry orange ice cream. Prepare cranberry pear ice, a version of the sorbets featured in the finest restaurants, as an elegant finale to a company dinner.

### Cranberry Orange Ice Cream

(Makes 1-1/2 pints)

- 2 navel oranges
- 1 (16 ounce) can Whole Berry Cranberry Sauce
- 1/2 cup sugar
- 1 tablespoon lemon juice
- 1 pint vanilla ice cream, softened

With a vegetable peeler, remove outer rind. Observe carefully to avoid white pithy parts. Cut flesh from remaining rind and remove seeds. In an electric blender container or food processor, place rind, orange pulp and whole berry cranberry sauce, cover. Whirl until coarsely chopped.

Transfer mixture to large bowl. Stir in sugar and lemon juice. Fold softened ice cream into cranberry mixture until well blended. Spoon ice cream into freezer container, cover and freeze until firm.



Clockwise top right:  
Cranberry Orange; Pina Colada;  
Cranberry Pear; Grapefruit Banana Daiquiri

### Pina Colada Ice Cream

(Makes 1-1/2 quarts)

- 2 tablespoons light rum
- 1 quart vanilla ice cream, softened
- 1 cup Whole Berry Cranberry Sauce
- 2/3 cup cream of coconut
- 1 (3-1/2 oz.) can flaked coconut

To toast coconut, spread on cookie sheet in 100° oven for about 5 minutes or until lightly browned. Whirl cream of coconut, softened ice cream and rum in blender. Transfer to large bowl and fold in whole berry cranberry sauce and toasted coconut until thoroughly combined. Spoon ice cream into freezer container, cover and freeze until firm (4 or more hours).

### Cranberry Pear Ice

(Makes 1-1/2 quarts)

- 2 (1 pound) cans pear halves in light syrup, drained
- 1 quart Cranberry Juice Cocktail
- Juice of one orange
- 1 cup white wine
- 1/4 teaspoon ground cinnamon
- 2 cups granulated sugar

In a blender, puree the pears and set aside. In a saucepan, bring cranberry juice cocktail, orange juice, wine, cinnamon and sugar to a boil over medium heat, stirring to dissolve the sugar. Remove from heat and stir in pear puree. Cool.

Process in an ice cream maker, according to manufacturer's directions. Freeze until serving time. The ice will stay an excellent, soft texture.

### Grapefruit Banana Daiquiri Ice Cream

(Makes 1-1/2 pints)

- 1 teaspoon grated lime rind
- 2 small ripe bananas, peeled and pureed
- 1 tablespoon lime juice
- 1/2 cup Grapefruit Juice
- 1/4 cup light rum
- 1 pint vanilla ice cream, softened

In a large bowl, combine lime rind, bananas, lime juice, grapefruit juice, rum and softened ice cream; stir until well blended. Spoon ice cream into freezer container, cover and freeze until firm.

# Some 'blues' you won't mind getting

**B**LUEBERRIES. How good they taste, and how nice they look in the myriad of dishes and pastries that will find their way to our tables during this very short season.

Oh, happy day when we get the blues! Beautiful fresh blueberries, that is. The produce counters all over town are turning blue. The fresh blueberry season is almost upon us.

That means that for the next few months we can really savor these all American berries. It seems we're enjoying them more and more each year. Last summer, we ate up more than 62,500,000 pounds of fresh blueberries during the season!

**BLUEBERRY PANCAKES** for breakfast. Blueberry muffins for the coffee break, and blueberries in low-calorie light summer salads at lunchtime. Blueberry milkshakes as a beautiful afternoon pick-up, and blueberry desserts — beautiful blueberry desserts — for dinner. Whose mouth doesn't water over the thought of blueberry cheesecake, blueberry pie, blueberry shortcake?

All the blueberries didn't go into pancakes and muffins and cakes, either. Gaining in popularity all the time is blueberry soup and, of all things, blueberry vinegar. Old-fashioned blueberry cobbles have made a big comeback with a new generation. Blueberry cookies are devoured by the thousands, and homemade blueberry sauces by the gallons.

**DON'T FORGET** the fresh blueberry drinks and frozen desserts. The Blueberry Yogurt Shake here is made in a blender and combines two healthful foods in a single glass. Nourishing and different, it's a delicious summer refresher.

If you haven't tried homemade Blueberry Ice yet, you're missing something. You might not buy a package of any other flavor sherbet from the freezer cabinet of the supermarket the whole time that fresh blueberries are in season. You'll make your own Blueberry Ice.

Throughout the time they are available, just make sure there are enough boxes of fresh blueberries in the refrigerator to make up into favorite blueberry dishes. While the berries themselves last in the refrigerator for two weeks, they never seem to "last." Somebody is always dipping into them for a handful or two.

### BLUEBERRY YOGURT SHAKE

- 1 cup fresh blueberries, washed and drained
- 1 cup plain yogurt
- 1 Tbsp. sugar
- 1/2 tsp. vanilla

In a blender, mix together blueberries, yogurt, sugar and vanilla until smooth. Makes 2 cups.

### BLUEBERRY ICE

- 1/2 cup sugar
- 1 1/2 tsp. unflavored gelatin
- 1 1/2 cups water
- 1 1/2 cups fresh blueberries, washed and drained
- 3 Tbsp. lemon juice

In medium saucepan, combine sugar, gelatin and 1 cup of water. Heat and stir over medium heat until dissolved. Remove from heat, add remaining water, berries and lemon juice. Freeze in refrigerator tray until firm. Break apart into chunks and beat until smooth. Return to tray and freeze until firm. Makes 8 servings.

**BUT LOVE** of blueberries is only one side of the berry. Roll that berry over and you'll see good nutrition.

Blueberries are the perfect snack food for children. They are high in food energy, contain only 41 calories per half cup and rank first of all berries in vitamin A. They are nature's convenience food, requiring no peeling, pitting or hulling.

Because everybody wants more and more and more recipes for preparing blueberries, here's a brand new effortless idea. Blueberry Almond Froth. There's the original version and a low-calorie one for people who are watching their weight or sugar intake. Celebrate the beginning of the blueberry season with this new and special blueberry dessert.

### BLUEBERRY ALMOND FROTH

- 2 envelopes unflavored gelatin
- 3 3/4 cups cold water
- 1 can (13 oz.) evaporated milk
- 3/4 cup sugar
- 1 Tbsp. almond extract
- 3 cups fresh blueberries, rinsed and drained

Soak gelatin in 1/2 cup cold water, set aside. Heat evaporated milk and remaining water until scalding. Stir in sugar. Pour milk mixture into gelatin mixture. Add almond extract. Stir well. Chill until mixture is consistency of unbeaten egg whites. Stir in blueberries. Spoon into dessert mold or cups. Chill until firm. Unmold onto serving plate to serve. Decorate with additional blueberries and almonds. Makes 6 to 8 servings.

**LOW CALORIE VERSION:** Substitute skimmed evaporated milk (same 13 oz. can) and 6 tablespoons of sugar substitute for the sugar. If served to eight: 70 calories per serving.



Fresh blueberries are best in Blueberry Ice and Blueberry Yogurt Shake.



# Take simmer out of summer

## Main dish salads keep cooks cool

Summer's the time to replace steamy meals with cooler culinary creations.

Refreshing main dish salads are ideal. Quick and easy to prepare, these artful entrees perk up wilting appetites and keep the cook and kitchen cool.

With lighter, fitness-conscious eating a way of life for so many people, main dish salads have reached new pinnacles of popularity and panache. Today's entree salads are creative combos of interesting ingredients that star on at-home menus and steal the show at picnics and al fresco meals, as well.

When the mercury soars, try one of the following main dish salad recipes. Served indoors or out, they're sure to become warm-weather favorites.

Tortellini Pesto Salad is a hearty combination of meat or cheese-filled pasta, summer's finest garden vegetables and herbs in a creamy, savory dressing. When you need a grillside go-along instead of an entree salad, substitute rotini (spiral pasta) for tortellini.

JAMBALAYA SALAD teams rice with ham, shrimp, bacon and Cajun-inspired vegetables and herbs for a spicy special entree with just the right touch of red pepper "heat."

Arranged on a bright bed of pea pods, Far East Chicken Salad features bean sprouts, soy sauce, ginger and mandarin oranges.

With the great popularity of Tex-Mex foods, Fiesta Taco Salad is sure to rate reviews. In north-of-the-border fashion it layers lettuce, tomatoes, olives, a spicy ground beef mixture and cheese. The colorful creation is topped with a tangy dressing and tortilla chips before serving.

### TORTELLINI PESTO SALAD

1 cup mayonnaise-type salad dressing  
 1/2 cup finely chopped fresh basil leaves  
 1/4 cup chopped parsley  
 1/4 cup (1 oz.) grated parmesan cheese

2 Tbsp. milk  
 2 garlic cloves, minced  
 2 cups cheese or meat tortellini, cooked, drained  
 1 cup 2-inch julienne-cut zucchini  
 1 cup 2-inch julienne-cut carrots  
 1 cup cherry tomato halves  
 1/4 cup chopped walnuts, toasted

Combine salad dressing, basil, parsley, parmesan cheese, milk and garlic; mix well. Add all remaining ingredients except walnuts; mix lightly. Chill. Stir in walnuts just before serving. Makes 4 servings.

### JAMBALAYA SALAD

1 cup mayonnaise-type salad dressing  
 1/2 cup celery slices  
 1/2 cup chopped green pepper  
 1/4 cup chopped onion  
 1 tsp. dried thyme leaves, crushed  
 1/4 tsp. ground red pepper  
 1/4 tsp. salt  
 1 garlic clove, minced  
 3 cups cooked rice  
 1 cup cubed cooked ham  
 1 6-oz. pkg. frozen cooked tiny shrimp, thawed  
 1 cup chopped seeded tomato  
 6 crisply cooked bacon slices, crumbled

Combine salad dressing, celery, green peppers, onions, seasonings and garlic; mix well. Add rice, ham, shrimp and tomatoes; mix lightly. Chill. Stir in bacon just before serving. 6 servings.

### FAR EAST CHICKEN SALAD

1/2 cup mayonnaise-type salad dressing  
 1 Tbsp. soy sauce  
 1/4 tsp. ground ginger  
 2 cups cubed cooked chicken  
 1 cup fresh bean sprouts  
 1/4 cup thin red pepper strips  
 1/4 cup sliced green onions  
 1 11-oz. can mandarin orange segments, drained  
 3 cups pea pods, halved diagonally, blanched, cooled



Ideal for sultry summer nights or toting to a picnic site, colorful main dish Tortellini Pesto Salad teams cheese- or meat-filled pasta with summer's finest garden vegetables and herbs.

1/4 cup cashews, toasted

Combine salad dressing, soy sauce and ginger; mix well. Add chicken, sprouts, peppers and onions; mix lightly. Chill. Stir in oranges just before serving. Arrange pea pods on serving platter; cover with chicken mixture. Sprinkle with cashews. Makes 4 servings.

### FIESTA TACO SALAD

1 1/2-oz. pkg. taco seasoning mix  
 3/4 cup mayonnaise-type salad dressing  
 1 lb. ground beef

3/4 cup water  
 3 cups shredded lettuce  
 2 cups chopped tomatoes  
 1/2 cup pitted ripe olive halves  
 1/2 cup (2 oz.) shredded sharp natural cheddar cheese  
 Tortilla chips

Combine 2 teaspoons seasoning mix and salad dressing; chill. Brown meat; drain. Add remaining seasoning mix and water; simmer 15 minutes, stirring occasionally. Cover serving platter with lettuce. Top with tomatoes, olives, meat mixture, cheese, salad dressing mixture and chips. 4 servings.

# Curry gives entree flavor

Warm Curried Shrimp and Wild Rice Salad is simple, straightforward and quick, with dazzling results. A light touch of curry and chutney complements the subtly seasoned blend of premium wild and long grain rices. And it takes just minutes to prepare this elegant-enough-for-company dish.

Warm Chicken Dijon Salad combines strips of cooked chicken, capers and red bell pepper with fast-cooking long grain and wild rice. A light tarragon vinaigrette completes the salad.

### WARM CURRIED SHRIMP AND WILD RICE SALAD

2 cups water  
 2 Tbsp. butter or margarine  
 2 garlic cloves, minced  
 1 pkg. (6 1/4 oz.) fast-cooking long grain and wild rice  
 2 Tbsp. lemon juice  
 1/4 tsp. curry powder  
 Dash red pepper flakes  
 3 Tbsp. chutney, finely chopped  
 1/4 cup vegetable oil  
 3/4 lb. cooked shrimp  
 1 green onion, finely chopped  
 2 Tbsp. coarsely chopped toasted almonds

Combine water, butter, garlic and contents of rice and seasoning packets in medium saucepan. Bring to a vigorous boil. Cover tightly and simmer until all water is absorbed, about 5 minutes. Meanwhile, combine vinegar, garlic, mustards and sugar. Whisk in oil. Stir into warm rice along with chicken, capers and red pepper. Heat through. Serve warm. Makes 8 servings.

is absorbed, about 5 minutes. Meanwhile combine lemon juice, curry powder, red pepper flakes and chutney. Whisk in oil. Stir into warm rice along with shrimp, onion and almonds. Heat through. Makes 4 servings.

### WARM CHICKEN DIJON SALAD

2 cups water  
 2 Tbsp. butter or margarine  
 1 pkg. (6 1/4 oz.) fast-cooking long grain & wild rice  
 2 Tbsp. tarragon vinegar  
 1 garlic clove, minced  
 2 to 3 tsp. Dijon-style mustard  
 1/4 to 1/2 tsp. dry mustard  
 1 tsp. sugar  
 1/4 cup vegetable oil  
 2 cups cooked chicken strips (about 1 x 1/4-inches)  
 1 Tbsp. capers, drained well  
 1 small red bell pepper, chopped, or 1 jar (2 oz.) diced pimiento, drained

Combine water, butter and contents of rice and seasoning packets in medium saucepan. Bring to a vigorous boil. Cover tightly and simmer until all water is absorbed, about 5 minutes. Meanwhile, combine vinegar, garlic, mustards and sugar. Whisk in oil. Stir into warm rice along with chicken, capers and red pepper. Heat through. Serve warm. Makes 8 servings.

# Pie is chilly delight

### CHOCOLATE CRUMB ICE CREAM PIE

1 1/2 cups graham cracker crumbs  
 1/4 cup butter, melted  
 1/4 cup sugar  
 3/4 cup mini semi-sweet chocolate bits  
 1 qt. ice cream, softened

In large bowl, combine graham cracker crumbs, butter and sugar; stir in chocolate bits. Press 2 cups crumb mixture evenly on bottom and sides of 9-inch pie pan. Chill until firm (about 30 minutes.) Fill with ice cream. Top with remaining crumb mixture. Freeze until firm.

**CLIP & SAVE**

**No Limit!**

**Dry Cleaning**

**1¢**

**No Limit!**

\*Bring in Any 2 Like Garments; pay the regular price on the 1st item, get the 2nd one for only 1¢.

(Offer Excludes Suits, Furs & Leathers) Hours: Mon.-Sat. 7:30 a.m.-7 p.m. Expires June 28, 1986.

**Touch of Spring Cleaners**  
 1 HOUR SERVICE AVAILABLE!  
 Coupon Must Be Presented With Incoming Order  
 Monday thru Saturday 7:30 a.m. to 7:00 p.m.

22012 Farmington Rd.  
 Farmington Crossroads  
 At 9 Mile  
 478-0180

**CLIP & SAVE**

**WINE SALE**

**\$2.99**

ITALIAN ASTI SPUMANTE

LIMIT 12  
 Good thru 6/29/86

**WINE BARREL**  
 of Redford 533-9463

25303 Plymouth Rd.  
 Between Beech & Telegraph  
 —OPEN SOON—  
 2nd LOCATION • 30805 PLYMOUTH RD. • 427-8483  
 Formerly the Elms Bros. Market

**Ackroyd's**  
 SCOTTISH BAKE HOUSE

**GET THRIFTY** thru 6/28/86

**BRIDIES** ..... 6 for \$2.85  
 (Beef & onion turnovers)

**SHORTBREAD** ..... \$3.35 doz.  
 1 doz. paks only

**What's New? Pizza Pasties!!**

**Pasties!** Tues. & Wed.

**Beef or Chicken**  
 Delicious meal to satisfy a hearty appetite!

**Only \$2.35 for 3 (Reg. \$2.65)**

Birmingham 300 Hamilton Rd. 540-3575  
 Redford 25586 Five Mile Rd. 532-1151

*Go For it!*

Be an Observer & Eccentric Newspaper carrier.  
 Call 591-0500 for details

**KEG BEER • POP • WINE • BEER**

**STAN'S DISCOUNT BEVERAGE**

ANN ARBOR ROAD AT ANN ARBOR TR. • 464-0496  
 GOOD THRU 6-29-86

Pepsi, Diet Pepsi, Mountain Dew, Pepsi Free, Diet Pepsi Free, A&W, Diet A&W, Vernors, Diet Vernors, Slice, Diet Slice

8 Pack 1/2 Liter **\$1.89** + Dep.  
 2 Liters..... \$1.38 + dep.

Regular & Light **\$8.99**  
**Coors Beer** -1.00 MAIL-IN REBATE  
 24 - 12 Oz. Cans **\$7.99** YOUR FINAL COST

**Faygo** 8/\$1.88  
 1/2 Liters Mix-N-Match + Dep.

Regular or Light **\$8.99**  
**Stroh's** 30 Packs + Dep.

**BLACK DIAMOND LAWN EDGING** \$11.50 + TAX  
 BUY 3 OR MORE \$10.50 + TAX

**Bulk Food Warehouse**  
 NEW LOCATION Expires 6-29-86

**COUPON MIXED NUTS (NO PEANUTS)**

SALT OR NO SALT **\$2.99** With LB. Coupon Only

Coupon Expires June 29, 1986.

**JOLLY RANCHER HARD CANDIES**  
 Only **99¢** LB.  
 Choose from 16 Individual Flavors

**MIXED VEGETABLE SHELLS OR SPIRALS**  
 Only **99¢** LB.  
 Great For Summer Salads

**FRESH CHEESE BALLS**  
 Only **99¢** LB. Reg. \$1.79

**SEE US FOR YOUR JUNE PARTY NEEDS!**  
**SAVE ON BUYING IN BULK!**

Ingredient Listings provided on bins for merchandise sold in bulk  
 FREE Recipes provided for Soups, Mixes & Gravies

**Bulk Food Warehouse**  
 WESTLAND CROSSING  
 Wayne & Warren Roads  
 Across from Westland Center  
 WESTLAND, MI 48092  
 525-2922  
 Monday-Sat. 10 AM-6 PM Sunday 11 AM-4 PM

CHECKS ACCEPTED FOR AMOUNT OF SALE  
 WE ACCEPT FOOD STAMPS

**George's DISCOUNT PRODUCE AND DELI**

38741 Ann Arbor Road • Livonia 464-0410

NOW OPEN SUNDAYS 10-6 MON-SAT 9-7

Fresh, Sweet **Corn** 6 for **99¢**

Sweet **Cherries** **88¢** LB.

Green Cabbage ..... **15¢** LB.  
 Sweet Watermelon .. **\$3.49** EA.

**Super Sub** **\$1.19** EA.

**Kowalski** Skinless Franks **\$1.99** LB.  
 Boblo Loaf **\$2.19** LB.  
 Stadium Kielbasa **\$2.49** LB.

Muenster or Mozzarella Cheese **\$1.79** LB.  
**Medium Cheddar**  
**Mild Pinconning**  
**Monterey Jack** **\$1.99** LB.

Roast Beef **\$3.39** LB.  
 Corned Beef **\$3.39** LB.

# SUMMER Specials

# SUMMER Specials

# SUMMER Specials

# SUMMER Specials



METRO DETROIT'S  
YOUTH  
BEDROOM CENTER

LARRY THE LIQUIDATOR'S  
**BUNK 'N  
TRUNDLE**

We're up to our neck in  
**overstock**

You'll SAVE  
20 to **60%**

New shipments on the way.  
We're forced to take drastic  
action to reduce our entire  
Store and Warehouse stock  
for immediate **SELL-OUT!**

OPEN  
WEEKDAYS  
10 AM-9 PM  
SAT. 10-6  
SUNDAY  
NOON-5 PM

Hundreds of furniture, accessory and  
bedding items are piling up faster than  
we can make room for them! Some-  
thing's gotta give! We can't give 'em  
away but you'll get incredible savings!

HUNDREDS OF BARGAINS  
LIKE THESE!

Save \$100<sup>00</sup> on  
rustic bunk bed  
outfit. Complete  
with ladder &  
guardrail.  
Woodtone finish.

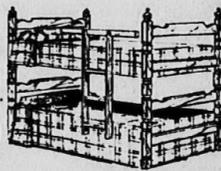

**\$129**



Mattress or  
Foundation **\$59**  
Reg. \$99 ea. Twin-size  
bedding pieces in your  
choice of regular or  
extra-firm.  
SOLD IN SETS ONLY

YOUR CHOICE



Trundle  
or  
Skipper's  
twin bed **\$199**  
Reg. \$399. Rugged charm in a  
maple finish with lots of  
storage space underneath or  
pop-up trundle bed

—THIS WEEK ONLY AT—  
LARRY THE LIQUIDATOR'S  
**BUNK 'N TRUNDLE**  
7210 MIDDLEBELT  
CORNER OF WARREN  
WESTLAND  
Ph. 421-1910

## Healthways

of Plymouth  
presents

**LOWER PRICES**  
throughout the store  
**Same Knowledgeable Staff**  
**Same Personalized Service**

- Free Lending Library
- Special Item Ordering
- Mailing Services
- Senior Citizens Discount

- Every Month:
- Free Skin Analysis Day
  - Free Natural Makeup Demonstration
  - Call For Appointment



### L-TRYPTOPHAN

L-Tryptophan is a natural amino-acid which aids in sleeping and relaxing. Safe, no side effects. 2 for 1.

**SLEEP INDUCER**

\$15.90 Value - 60 TABS

### OMEGA-3

is a Cholesterol Fighter and benefits the heart by reducing fats and cholesterol.

**CHOLESTEROL FIGHTER**

Regular \$9.50 - 60 Caps



### KYOLIC

Reduces high blood pressure by either neutralizing the poisonous substances in the intestines or acting as a vasodilator. Soviets call it "Russian Penicillin."

**BLOOD PRESSURE FIGHTER**

Regular \$9.51 - 100 Caps

### CALCIUM & MAGNESIUM WITH ZINC

Essential for healthy blood, sound sleep, nerves and the building and protecting of bones.

**OSTEOPOROSIS FIGHTER**

\$15.00 Value - 250 Tabs



### SOD 3

Going on vacation? Then you don't want jet lag to spoil your fun. SOD 3 is the answer.

**JET LAG FIGHTER**

Regular \$5.95



### GRAPEFRUIT FORMULA

The famous dieter's aid. Natural Grapefruit Glucosannan B-6, Kelp, Lecithin & Cider Vinegar!

**DIETER'S FRIEND**

\$7.90 Value - 60 Tabs

### RACHEL PERRY TANNING FORMULA

Screens out burning rays & promotes a healthy golden tan. Use to protect & moisturize skin during all outdoor activities.

**NATURAL SUNSCREEN**

\$10.00 Value

Soft Serve  
**TOFUCCI**  
Cones, Sundaes,  
Containers

Everyday  
Delicious Homemade  
Sandwiches &  
Lunch Items

**FREE**  
Indology Readings  
Fridays 2-5 p.m.  
Takes 5 Minutes  
No Appt. Necessary

**FREE**  
Therapeutic  
Mini-Massage  
Saturdays 11-3 p.m.  
Takes 10-15 minutes  
No Appt. Necessary

**Healthways Coupon**  
**\$3.00 OFF** Any purchase of \$15 or more. Expires 6-30-86.

## Healthways of Plymouth

"A Natural Health Center in Downtown Plymouth"  
**KNOWLEDGE • SERVICE • LOW PRICES**  
942 W. Ann Arbor Trail • Plymouth • 455-1440  
M-Th 10-7; Fri. 10-9; Sat. 10-6

## MISS LIVONIA SCHOLARSHIP PAGEANT

7 PM SUNDAY - JUNE 29, 1986



HELD OVER

OVERWEIGHT MEN & WOMEN

**Weight Loss Clinic**  
announces our  
**11th ANNIVERSARY  
SPECIAL**

**50% OFF**  
Our regular \$98 program  
is now only  
**\$49.00\***

Now for a limited time only,  
our \$98 program is yours for  
1/2 price — Only \$49.

Take advantage of our anni-  
versary special and let our  
nurses help you lose weight  
quickly and safely without fad  
diets, drugs or prepackaged  
foods.

Call now for a free weight loss  
consultation. But do it now —  
because the price may never  
be this slim again!

**WEIGHT LOSS CLINIC**  
Our Nurses make the difference

\*For new clients only

- BLOOMFIELD HILLS 355-2977
- ORCHARD LAKE 455-0600
- GROSSE POINTE 372-3200
- LIVONIA 767-7500
- PLYMOUTH 455-4424
- STERLING HEIGHTS 979-2100
- ROCHESTER 936-9911
- SOUTHFIELD 967-1100
- RENAISSANCE 367-5555
- ALLEN PARK 361-3222
- ANN ARBOR 973-7600
- WINDSOR EAST 917-4242
- WINDSOR WEST 966-2110
- PLYMOUTH MICHIGAN 713-7500

Wonderland Mall  
Plymouth & Middlebelt Roads - Livonia, MI



# Suburban Life

Julie Brown editor/459-2700

Monday, June 23, 1986 O&E



Illustration by BILL SPRELLER/staff photographer

Packing snack foods and making regular stops help to keep youngsters happy during trips by car. Canton Township's Erin Kurtz follows that advice with her niece, Kristin Moran (left), and sons Christopher (center) and Nicholas Kurtz.

## Keeping kids busy on the road

By Julie Brown  
staff writer

**T**RAVELING BY car with children can try the patience of even the most understanding parent.

Summertime outings need not be disasters, however. Planning ahead can help make vacation trips by car more comfortable for youngsters and adults alike.

Keeping children occupied during travel time is a big help.

"That's the key to the whole thing," said Jerry Cheske, spokesman for AAA-Michigan. "Find something to keep them occupied."

Roadside games — such as who can count the most cars of one particular model and color — can be used to help keep kids occupied, he said.

A list of items, such as a maple tree, a cow, a drugstore, can also be made ahead of time. The players then search for the different items, with the one who finds them all first winning the game.

Simple board games, with relatively few playing pieces, and card games can also be used to keep youngsters busy during trips by car, Cheske said.

Parents don't have to spend large sums of money to keep children occupied during summertime travels. "Just use your imagination. You don't have to go out and buy things."

**PARENTS MAY** want to take along small items to give as awards to game winners, Cheske said. Games can vary in their complexity, according to the length of the trip and the ages of the children.

Parents should plan ahead by providing snacks for youngsters.

"Take little snacks along," Cheske said. "Kids get hungry or they get thirsty."

Certain food and beverage items are more practical than others for vacation travelers. Juice boxes, with attached straws, are less likely to

create a mess than other beverage containers.

It's also important to stop every few hours when traveling by car, Cheske said.

"Certainly not longer than three hours."

Stopping allows all travelers to get out and stretch their legs — and to use the restrooms. Stops should be made at places that allow youngsters to move about freely and safely, Cheske said.

**BRINGING ALONG** pillows and blankets also helps make trips more comfortable for young travelers.

"You try to make it as comfortable as you can for them," Cheske said.

Those who are traveling in station wagons or vans shouldn't let youngsters play in the vehicle's back area, he said. A sudden stop while children are in that area could lead to serious injury or death.

"That's probably the hardest thing to do, but it's the one thing you must do." Children should be in their seats, with seat belts on, at all times when the car is moving, Cheske said.

Sgt. David Ford, of the Michigan State Police Traffic Services Unit at the Northville post, agreed. Allowing youngsters to move about in a car or van while on the road can lead to tragedy, he said.

"Every once in a while you see it, and you just shudder."

Michigan law requires the use of child restraint seats. Up to age 1, infants traveling in cars must be in an approved infant seat, according to Ford.

After that, up to the age of 4, children must ride in a child restraint seat while sitting in a car's front seat. In the back seat, children ages 1 to 4 must use the car's seat belts.

**THE STATE** law requiring motorists to use child restraint seats is designed to be educational rather than punitive, Ford said.

*"That's the key to the whole thing. Find something to keep them occupied."*

— Jerry Cheske  
AAA-Michigan

"If they do receive a ticket, they can get the fine and costs waived." The law allows for that, provided motorists prove they have bought or rented an approved car seat.

Proper use of the child restraint seat is also important, according to the Michigan State Police sergeant.

"It's got to be installed properly and used properly." The directions with the child restraint seat will indicate how it should be used.

Use of child restraint seats — and of seat belts — is a good safety measure for all motorists, Ford said. "It's just a common sense thing."

### clubs in action

**• MORE OPTIONS**  
"Increase Your Options" is the topic for the 7 p.m. Tuesday, June 24, meeting of the Women's Divorce Group. The meeting will be held in the Lower Waterman Campus Center conference room at Schoolcraft College, 18800 Haggerty, Livonia. Becky Dolan, private counselor and Schoolcraft College instructor, will present the program. She will discuss ways to increase self-confidence and gain personal independence. There is no charge and advance registration is not required. The session is sponsored by the Women's Resource Center at Schoolcraft College. For additional information, call 391-4400 Ext. 430.

**• LA LECHE**  
The Plymouth-Canton La Leche League will meet at 7:30 p.m. Thursday, June 24. Expectant mothers and those with nursing babies may attend. For additional information, call Gloria, 464-9714, Karen, 464-1522, or Cynthia, 467-1427.

**• WISEN**  
WISEN (Widowed In Service) will meet at 8 p.m. Tuesday, June 24, at St. David's Episcopal Church, 37800 Marquette, Garden City. The speaker will be the Rev. Robert Walker, who will discuss "Healthy Grief." Reservations are not required. The organization provides self-help and information sharing for widowed persons. Any widowed person may attend. For additional information, call the Women's Resource Center at Schoolcraft College, 391-4400 Ext. 430.

**• RETIRED PERSONS**  
The Plymouth-Northville Chapter 1511 American Association of Retired Persons will hold the final meeting of the year Wednesday, June 25, at the Plymouth Cultural Center. The Livonia Senior Choir will entertain. The meeting will be at noon. Board members should meet at 11 a.m. Those attending should bring a sack lunch. Coffee, tea and cake will be offered. Donations of canned goods will be taken for the Salvation Army.

**• BALL GAME**  
The Christian Singles will go to the ball game Saturday, June 28, to watch the Detroit Tigers play the Milwaukee Brewers. Game time is 7:15 p.m. Those attending should meet at 11:30 a.m. in the parking lot of the First Presbyterian Church, Plymouth. For information on getting tickets, call 453-6464.

**• OPEN HOUSE**  
On Sunday, June 29, the Friends of the Matthei Botanical Gardens will hold the annual Open House at the Botanical Gardens, 1800 N. Dixboro, Ann Arbor. The event is a joint affair with the Humane Society of Huron Valley, 3109 Cherry Hill Road, Ann Arbor.

Please turn to Page 6

## Timely tips

This advice is worth remembering

By Janice Brunson  
staff writer

**T**HE TERMS "sir" and "madam" are taboo in Jeremy Haworth's opinion.

According to Haworth, a training coordinator with Memory Master Institute Inc., there is no reason in the world to forget a name. Worse, he says, using generic terms such as sir or madam are dead giveaways that a name has been forgotten.

On a personal level it is embarrassing to forget a name. But when it comes to business, it can cost money. Forgetting can be avoided.

This was Haworth's message earlier this month to 50 women at the Livonia Hollidays who were breakfast guests of management from Kelly Services in Livonia and Farmington Hills.

Most of the women are personnel directors or employed in related fields for companies such as Delco Products-Livonia or Adistra Corp. They all use Kelly Services. The breakfast is one in a continuing series

message using a memory demonstration. Fifteen items, each randomly suggested by different members in the audience, were listed in the order they were named. When the women were asked to recall the list in the same order just minutes later, most were unable to go beyond five.

Still later, Haworth accurately rattled off the list at lightning speed. He repeated the process a second time in perfect order — backwards.

Haworth, a former engineer and race car driver, said the first time he participated in the demonstration, he managed to name three. Since taking the Memory Master course last August, he said, remembering 15 is easy. In fact, remembering 20 isn't all that hard.

Haworth maintains that most of us are born with similar faculties. Memory is not a reflection of I.Q. It is a matter of determination and skill. It takes practice and training.

Memory Master is the new kid on the block in the memory business. It was founded nearly three years ago by Mark DeFoor, 38, an attorney who

president, Tim Olson, the course differs from others on the market because Memory Master is based on "doing." We teach techniques that are applied and practiced on the spot, Olson said. "Our course is a genuine workshop, not a seminar."

**THE COURSE** consists of three separate sessions, each three hours long. It is taught only in a group environment.

"Group dynamics is an important factor in the course," Olson said.

The course is a continuing process, and one principle builds upon the next, Olson said. Many of the principles are "good common sense that we all know but don't consciously register."

The course concludes with a mock social event where trainees meet as many new people as possible, utilizing new memory skills to remember names.

Haworth said 1,500 people in the greater Detroit area completed the

### Protect Your Greatest Asset...Your Health

Join us at our FREE Health Discussions

Monday, June 23, 7:00-8:00 P.M.  
Topic: "Healthy Heart", co-sponsored with the American Heart Association.

Learn how to maintain a healthy heart by watching the foods you eat and the lifestyle you live.

Tuesday, June 24, 7:00-8:00 P.M.  
Topic: Immunizations for your child, including the new Hib vaccine.

The American Academy of Pediatrics stresses the need for immunization against eight serious infectious diseases. UMA Pediatrician, H. Amin, M.D. will explain these immunizations and answer questions.

Wednesday, June 25, 7:00-8:00 P.M.  
Topic: The Importance of Breast Self Examination (BSE)

Janet K. Baum, M.D., UMA Director of Radiology and specialist in mammography, will present a video tape demonstration of BSE, followed by a question and answer session.

Thursday, June 26, 7:00-8:00 P.M.  
Topic: "Taking Control," co-sponsored with the American Cancer Society.

A new program stressing 5 protective factors to add to your diet, in order to help reduce your cancer risk, including a video tape.

Saturday, June 28, 10:00-11:00 A.M.  
Topic: The Importance of Breast Self Examination

Program ends at Wednesday, June 25

No Registration Necessary, Refreshments Provided  
UMA MULTI-SPECIALTY MEDICAL CENTER  
35601 Warren  
Presented in a

## clubs in action

Continued from Page 5

Arbor. Hours will be 1-4 p.m. There will be public tours and displays at both facilities, with staff members and docents available to answer questions. At the Botanical Gardens, the Conservatory will be open to the public free of charge. For additional information, call the Matthaei Botanical Society, 763-7060, or the Humane Society, 662-5585.

### PICNIC FUN

The Plymouth Township Seniors will celebrate Independence Day at noon Wednesday, July 2, with a picnic at Plymouth Township Park, Ann Arbor Trail at McClumpha. Hot dogs will be served. Members should bring a dish to pass, their own beverage and a place setting. The organization was recently honored when one of its members, Isabell Maurer, was nominated for the annual Michigan Outstanding Senior Citizen of the Year Awards by the Plymouth Council on Aging. For additional information on the Wednesday, July 2, picnic, call Helen Krupa, 459-6259.

### FLUTE WORKSHOP

A flute workshop will be held July 8-15 at Madonna College, 36600 Schoolcraft, Livonia. Detroit Symphony Orchestra flutist Shaul Ben-Meir will direct the workshop, with assistance from Sheryl Cohen, flute professor at the University of Alabama, Cynthia Ferris, Madonna College flute instructor, and Jackie Hof-to, professor of flute at the Interlochen Arts Academy. A recital at the end of the workshop will be Tuesday, July 15, in Kresge Hall on the Madonna campus. The recital will be open to the public free and features classical selections. Workshop sessions will be in Rooms 188 and 186. The fee for the workshop, sponsored by Flute World, is \$160. For additional information, call Flute World, 855-0410, or Sister Edith Marie, chairwoman of the college's Music Department, 591-5098. Madonna College is at the intersection of I-96 and Levan in Livonia.

### CERAMIC TILES

The gift shop at the Plymouth Historical Museum has received the first ceramic tile, with a sketch of the Wilcox House. This is the first in a series of tiles of Victorian houses in Plymouth. The first tile was presented to Jack Wilcox, owner of the Wilcox House and a member of the Plymouth Historical Society. The tiles are available for \$7.50 at the museum. Proceeds from the gift shop are used for the Plymouth Historical Museum's operations. The Plymouth Historical Museum (455-8940) is at 155 S. Main, Plymouth.

### FOR PARENTS

Northwestern Guidance Clinic of Wayne County is offering a parenting program for parents of children age 18 months to 5 years. The Parent-Child Enrichment Program is a five-week class. It will cover listening skills, problem solving and behavior management. Participants must live in suburban western Wayne County and must meet income eligibility guidelines. For additional information, call Toni Charles or Denise Tardif, 425-6110.

### BETHANY

Bethany Plymouth/Canton meets at 8 p.m. the third Saturday of each month at St. Kenneth Church, 14951 Haggerty, Plymouth. For additional information, call 981-1274 or 981-1365 after 6 p.m.

### OPTIMISTS

Club meets at 7 p.m. the first and third Mondays of each month in the Miles Standish Room of the Mayflower Hotel. Plymouth and Canton residents may call 453-8547 for membership information.

### CHORUS COOKBOOK

Plymouth Community Chorus cookbook, "All Our Best," is available at Plymouth Book World and from chorus members. Price is \$7.95.

### EATING DISORDERS

An Eating Disorder Support Group meets 6:30-8 p.m. every other Wednesday at the Institute for the Study of Eating Disorders, 23800 Orchard Lake Road, Farmington Hills. There is no charge. Meetings are open to those with eating disorders and to their friends and family members. For additional information, call Margaret Flannery or Andrea Cisko, 474-1144.

### FARM AND GARDEN

The Lake Pointe Women's National Farm and Garden Association has two cookbooks available from group members. A number of salads from the spring salad luncheon are included, along with other recipes submitted by the members. The price is \$5. For additional information, call Jean Pink, 453-2802.

### CANTON WOMEN

The Canton Women's Club will meet 9-11 a.m. the first and third Thursday of the month at the Faith Community Moravian Church, 46001 Warren Road, west of Canton Center, Canton Township. New members may attend. The club is for women interested in being a part of cultural events, group discussion and recreational activities. The club is co-sponsored by the YWCA of Western Wayne County. For additional information, call Betty Gruchala, president.

ation, call area program director Cynthia Nichols, 561-4110.

### PLYMOUTH SENIORS

The Plymouth Township Seniors meet at the Friendship Station Club Hall, 42375 Schoolcraft, on the following days: Mondays from 10 a.m. to noon for euchre and pool, Tuesdays 6:30-9:30 p.m. for pinocle, Fridays from 11:30 a.m. to 3:30 p.m. and 6:30-9:30 p.m. for bridge and pinocle. Seniors living in Plymouth Township or the city of Plymouth may attend. For additional information, call Helen Krupa, 459-6259.

### DANCERS' COOKBOOK

The Polish Centennial Dancers of Plymouth cookbook, "Secrets from Centennial Cupboards," is available from group members. It features a number of Polish recipes, along with American recipes. The price is \$5. For additional information, call Kathy Floied, 459-7255.

### AGORAPHOBICS

Agoraphobics in Motion (AIM) meets at 7:30 p.m. Thursdays at the Faith Lutheran Church, 30000 Five Mile, Livonia. AIM is a support group for those whose lives are troubled by anxiety/panic disorders of agoraphobia and other disorders. For additional information, call 547-0400.

### FAMILIES ANONYMOUS

Families Anonymous, a self-help program for relatives and friends concerned with drug abuse or behavioral problems, will meet at 8 p.m. Thursdays in St. John Neumann Catholic Church, 44800 Warren, Canton.

### VFW BREAKFAST

Mayflower Lt. Gamble Ladies Auxiliary Veterans of Foreign Wars has a pancake breakfast the first Sunday of every month at the VFW Hall, 1426 S. Mill, just north of Ann Arbor Road. Menu includes pancakes, sausage, eggs, toast and French toast. Price is \$2 and \$1 for children 5 and younger.

### ST. JOHN NEUMANN SENIORS

The 50-Up Club meets at 7 p.m. the first Tuesday of each month at the church on Warren Road, west of Sheldon. New members may attend. For information, call Betty Gruchala, president.

### U.S. COAST GUARD AUXILIARY

United States Coast Guard Auxiliary Canton Flotilla 11-11 meets the fourth Tuesday of the month in Room 2510, Plymouth Salem High School, 46181 Joy, just west of Canton Center. The flotilla welcomes

new members. Call Robert Kinsler, 455-2676, for information.

### TAKE OFF POUNDS

TOPS Chapter 1236 meets every Thursday evening in Faith Community Church, 46001 Warren, Canton. Weigh-in starts at 6:30 p.m., with a meeting following, 7-8 p.m. For information, call 981-0446.

### CIVIL AIR PATROL

Air Force Auxiliary Squadron 16-1 invites interested people to attend its weekly meetings, 6:30-10 p.m. Thursday, on the fourth floor of the main building, Willow Run Airport. Any U.S. citizen 13 or older may become a volunteer. For information, call Robert Eizen, commander, 326-9673.

### TOPS MEETING

TOPS (Take Off Pounds Sensibly) meets 7:30-8:30 p.m. Wednesdays in Central Middle School, Main at Church, Plymouth. Ideas on weight reduction are discussed. For information, call 453-4756 or 455-1583.

### CANTON BPW

Canton Business and Professional Women meets the second Monday of each month at the Roman Forum Restaurant on Ford Road. Cocktails at 6 p.m., dinner at 6:30 p.m., and program at 7:30 p.m. Dinner charge is \$7.50 per person. Call Susan Pack, 455-0873, for information.

### SWEET ADELINES

Sweet Adelines Chapter of Sweet Adelines rehearses in the Senior Citizen Fire Station, 10800 Farmington Road, Livonia, just south of Plymouth Road. Women who like to sing four-part harmony may attend. For information, call Pat Daubemier of Canton, 981-4098, or Barbara Williams of Westland, 721-3861.

### ZESTERS

Zesters, a club for Canton residents 55 and older, meets at 12:30

p.m. Thursdays in the Canton Recreation Center, 44237 Michigan at Sheldon. Membership fees are \$1 to join and \$1.50 per month. For more information about the club, call the Canton senior citizen office, 397-1000 Ext. 278.

### CIVITAN CLUB

The Plymouth-Canton Civitan Club meets at 6:30 p.m. the third Thursday of each month. Men and women may attend to learn about Civitans — a group of neighbors, business associates and friends — all volunteers interested in programs and projects based on the needs of the community. Call 453-2206 for more information.

### TOASTMASTERS

The Oral Majority Toastmasters Club of Plymouth invites visitors to see how the club enables members to speak up and move ahead, whatever their occupations. The club meets at 5:30 p.m. Tuesdays at Denny's restaurant, Ann Arbor Road at I-275.

For information, call Phyllis K. Sullivan, 455-1635.

### MAYFLOWER-LT. GAMBLE POST VFW

Mayflower-Lt. Gamble Post 6695, Veterans of Foreign Wars, meets at 8 p.m. the second and fourth Tuesdays of the month at the post home, 1426 S. Mill, Plymouth. New members are welcome. For information, call the post, 459-6700.

### CANTON ROTARY

Canton Rotary Club meets at noon Monday in the Roman Forum on Ford Road between Haggerty and Lilley. Lunch is \$5. For information, call Richard Thomas, 453-9191.

### WOMEN FOR SOBRIETY

Self-help group for alcoholic women meets 1 p.m. Tuesdays in Newman House, Schoolcraft College campus, Haggerty at Seven Mile, Livonia. A hot line, 427-9460, operates 24 hours a day.

## new voices

Richard and Polly Bradburn of Plymouth announce the birth of a daughter, Emily Anne, May 25 at St. Joseph Mercy Hospital, Ann Arbor. Grandparents are Robert and Dorothy Richards of Canton Township and Warren and Vivian Bradburn of Plymouth. Great-grandmothers are Gladys Gots of Plymouth and Cleo Fosdick of Ypsilanti.

Stanley and Susan George of Manchester, Tenn., announce the birth of a son, Daniel Robert, June 17 in Tennessee. Grandparents are Mrs. Ar-

dyth Sockow of Plymouth and Mr. and Mrs. Robert George of Tennessee. Daniel Robert has two sisters, Valerie, 8, and Robin, 1½.

Archie and Martha Hewett of Livonia announce the birth of a son, Archie Ardell III, June 14 at St. Joseph Mercy Hospital, Ann Arbor. Grandparents are Archie Sr. and Dorothy Hewett of Harrisville, Mich., formerly of Livonia, and the late, goodwin and Eunice Crumbe. Archie has three sisters, Stacy, 12, Anne, 10, and Ashley, 2.

**Arthritis Today**  
Joseph J. Weiss, M.D. Rheumatology  
20317 Farmington Road  
Livonia, Michigan 48152  
Phone: 478-7860



### MILWAUKEE SHOULDER

Milwaukee shoulder takes its name from the doctors at the Medical College in Milwaukee, Wisconsin, who first brought this condition to the attention of the medical community.

Milwaukee shoulder is a form of osteoarthritis that has several special characteristics: it occurs only in women over age 65, and is associated with large amounts of fluid in the shoulder joint, which keeps accumulating. In addition, women with this condition tend to have arthritis in their knees and hips which is severe and often needs surgical joint replacement.

Milwaukee shoulder is caused by a bone crystal: hydroxy-apatite. The crystal acts like a poison and causes the joint lining cells to disintegrate, releasing enzymes into the joint cavity. The enzymes act on the surrounding bone to release more hydroxy-apatite crystals, and so perpetuate the cycle of cell disintegration and bone loss.

Treatment consists of shoulder joint aspiration and injection to remove the fluid and prevent the enzymes from acting on bone. Surgery is a last resort because of the hazards of operation on an elderly individual, and the difficulty of repair in a shoulder joint plagued with thin bone.

# ALL AMERICAN SALE

## The Lace Curtain Shop

- By the Yard
- With Rod Pocket
- Ready to Hang
- No Sewing
- Machine Wash & Dry

- Tablecloths
- Doilies
- Placemats
- Bedspreads
- Wallhangings

## The Lace Curtain Shop

BRITISH MADE LACE CURTAINS

33216 Grand River  
Farmington • Mon.-Sat. 10-6(1 blk. East of Farmington Rd.)  
471-2058

10%-25% OFF

Bridal Attendant  
Gifts  
• Cross Pens • Attendant Charms  
• Engraved Glasses • And More

10% OFF

Wedding and  
Shower Decorations

20% OFF

Packaged Bridal  
Shower Invitations (3 or more  
packages)

10% OFF

Printed Napkins  
and Matches

25% OFF

Custom Printed  
Wedding Invitations (see  
also the RUSH orders)

## Misty's Cards and Gifts

6209 Middlebelt, Garden City

Between Warren &amp; Ford Roads

HOURS: M, T, W, S 9-6; Th. 9-8; F 9-7

421-1066



## CHINA SALE

Our low prices on casual place settings

LENOX Chinastone*	NORITAKE	DANSK
*Popper on Blue..... 37.99	*Kilkee..... 15.75	*Christianshavn Blue..... 21.95
*Buttercups on Beige..... 41.75	*Eternal Blush..... 15.75	*Bismarck Blue..... 21.95
*Blossoms on Beige..... 41.75	*Painted Desert (4 pc.)..... 17.50	*Bismarck White..... 21.95
*Tulips on Grey..... 41.75	*Sunset Mesa (4 pc.)..... 17.50	*Maribu..... 21.95
*Iris on Grey..... 41.75	*Woodstock..... 18.95	*Fredrikborg Blue..... 21.95
*Night Life (4 pc.)..... 33.99	*Cafe Du Soir..... 19.50	*Damask..... 30.00
*Pinstripes Patterns..... 33.99	*Cafe Du Jour..... 19.50	*Twill..... 30.00
	*Partners..... 15.75	*Jacquard..... 30.00
		*Belle Fleur..... 21.95
		*La Tulipe..... 21.95
		*Adagio..... 21.95
		*Allegro..... 21.95

\*All 4 pc. settings

ARMINGTON HILLS  
Shower's Business Center  
11000 G. Farmington Road  
728-9222

## SUMMER SPECIALS

### Special! SEWING MACHINE CLEAN & OIL

Reg. \$22.95  
**\$12.50**

1. Check, batteries.
2. Oil and clean entire machine
3. Lubricate, inspect electric motor
4. Inspect all moving parts
5. Inspect all wiring for safety
6. Clean, adjust all light control mechanisms

Coupon Good thru 7-31-86

**HOWELL**  
SEWING & VACUUM CENTER  
SALES & SERVICE

COME IN OR CALL 822-0077

### Special! VACUUM CLEAN & OIL

Reg. \$18.95  
**\$9.50**

1. Oil & Clean Entire Vacuum
2. Inspect Motor
3. Inspect All Moving Parts
4. Inspect Wiring for Safety
5. Check Drive Belts
6. Check Brush Roller
7. Inspect Outer Bag

Coupon Good thru 7-31-86

6221 Middlebelt  
Garden City, MI 48135  
Next Door to "Villa Bakery"

## Whitehead Carpentry

Builder of Fine Wood Decks

729-4569

## HAIRGARE mod-cuts

MAXIMUM VALUE FOR YOUR MONEY  
NOW OPEN SUNDAYS  
12-4  
HAIR CUTS '6"  
Anytime, Any Length, Any Age  
No Appointments Ever Necessary

COUPON  
MAXI-PERM  
ONLY \$23.95  
Expires 7-7-86

COUPON  
MAXI-STYLE  
\$7.75 Reg. \$8.76  
Includes Shampoo, Wash-Out & Finish  
Expires 7-7-86

5725 S. TELEGRAPH DEARBORN HCTS. 295-4000  
34775 WARREN WESTLAND 729-1495

## campus news

Maura Cady of JoAnn Lane, Plymouth, has been listed in the 1986 edition of "Who's Who Among Students in American Universities and Colleges." Cady, a student at Siena Heights College, Adrian, was selected by a campus nominating committee because of her demonstrated leadership.

**● MARIANNE SAROWSKI**  
Marianne Sarowski, daughter of Edwin and Genevieve Sarowski of Canton, earned a doctor's degree from the Illinois College of Optometry, Chicago.

**● ALBION GRADS**  
The following residents earned degrees from Albion College:  
From Canton: Susan Gualda of Copeland Circle who graduated cum laude.  
From Plymouth: Andrea

Holowicki of Westbury, Jeffrey Howell of Beacon Hill Drive, Michael McBride of Brookwood and Judson Scott of Portsmouth Cross.

**● DR. MAC**  
Michael Mac of Plymouth earned a doctor's degree from the University of Wyoming in Laramie, Wyo.

**● SC HONOREES**  
Plymouth-Canton students at Schoolcraft College honored for earning grade point averages of 3.25 or better in the winter term were:

Nancy Adamski, Paul Blome, Valerie Bongiorno, Allene Boughton, Amy Dawson, Lynn Dawson, Carolyn Gates, Stanley Gordon, Loretta Keller-Juergens, Elizabeth Kushman, Sandra Marulis, Melissa Miller, Deborah Richards, Catherine Richardson, Michael Richardson,

Deborah Schnoes, Keith Sockow and Kathryn Waiter.

**● JOHN BARNES**  
John Barnes of Plymouth, who will be attending the University of Michigan-Dearborn this fall, has been awarded a Chancellor's Partial Scholarship by the university.

**● WSU GRADS**  
The following residents earned the medical doctor degree from Wayne State University School of Medicine:

From Plymouth: Mary Kay Balluff, Agnes Ohno, Parag Parikh and Jonna Schmidt. From Canton, Alice Brooks.

**● THOMAS MUSSELMAN**  
Thomas Musselman of Plymouth was inducted into the Tau Beta Pi national engineering honor society at

the Lawrence Institute of Technology, Southfield.

**● KEVIN FIELMAN**  
Kevin Fielman of Plymouth was named to the dean's list at the University of South Carolina, Columbia, S.C., for earning a grade point average of 3.25 or better.

**● PHILIP PFLUGH**  
Philip Pflugh of Cumberland Drive, Canton, was named to the dean's list at Northern Michigan University, Marquette, for earning a 3.25 grade point average or better.

**● BLANCA WONG**  
Blanca Wong, a 1985 Plymouth Canton High School graduate, was initiated into the Gamma Omicron chapter of Zeta Tau Alpha at Central Michigan University where she is a freshman.

**● JOEL ASHTON**  
Joel Ashton of Beacon Hill Drive, Plymouth, a Kalamazoo College freshman, was named to the dean's list for earning a 3.5 grade point average or better during the winter term.

**● JAMES GARAVAGLIA**  
James Garavaglia of Plymouth, a vice president with Comerica Inc., earned a doctor's degree from Wayne State University.

**● UM-D GRADS**  
The following residents earned degrees from the University of Michigan-Dearborn:

From Plymouth: Lisa Gentella, Kim Thomas, Violeta Hasani, Joni Quenneville, Craig Oster, Stephen Stewart, Edward Stirton, Marie Morrow, Leslie Bonville and Mark Swanson.

From Canton: Paul Ling, Allan Blasak, Miles McAnally, Gary Palgut, Scott Carson and Kenneth Akers.

**● CMU GRADS**  
The following residents earned degrees from Central Michigan University:

From Canton: Perry Littrell of Ranier, Mary Ann Reed of Woonsocket Drive, Kathryn Rice of Sussex, John Safran of Pickwick Drive, Holly Davis of Hanford and Timothy Kemp of Simsbury.

From Plymouth, Keith Stone of Ivywood.

**● TOM BRAUN**  
Tom Braun of Manton Boulevard in Canton was named to the dean's list at the Denver Automotive and Diesel College in Denver, Colo., for earning all-A's.

**● CRAIG OSTER**  
Craig Oster of Plymouth is one of the top 17 honor students graduating from the University of Michigan-Dearborn.

**● LEANNE YOUNG**  
Leanne Young of Bruce, Plymouth Township, a Plymouth Canton High School senior, has received the Rec-

ognition of Excellence Scholarship for \$1,000 from Eastern Michigan University.

**● LISA PARMER**  
Lisa Parmer of Plymouth received a runner-up award in the Schoolcraft College Youth Living Center Summer Celebration poster contest.

**● EILEEN HESS**  
Eileen Hess of Simpson, Plymouth, earned the Premio Alfonso X el Sabalo Award at Western Michigan University for demonstrating excellence in written and spoken Spanish.

**● ROBERT REUTER**  
Robert Reuter of Thorwood Drive, Canton, earned the Science Challenge Award, a financial reward to the Adrian College junior sciences student with the highest grade point average.

**● DONALD NELSON**  
Donald Nelson of Canton earned a bachelor's degree from Alma College.

**● MARITA HEALY**  
Marita Healy of Blunk, Plymouth, was named to the dean's list at the University of Dayton (Ohio) for earning a grade point average of 3.5 or higher.

**● PATRICIA CURTISS**  
Patricia Curtiss, daughter of Francis and Donna Curtiss, Roundtable Drive East, Canton, was awarded a fellowship at St. Mary Hospital, Winona, Minn.

**● HILLSDALE GRADS**  
Jeffrey Hubert, son of Judith Bartzloff of Admiralty, Canton, and Michael Hubert of Northville, earned bachelor's degrees from Hillsdale College.

**● BUTLER HONOREES**  
Janice Bublin of Leighwood Drive, Plymouth, and Brian Murray of Honey Lane, Canton, were named to the honor roll at Butler University, Indianapolis, Ind., for earning grade point averages of 3.0 or better.

## medical briefs/helpline

**● WEIGHT CONTROL**  
The weight-loss programs offered by the Institute for Behavioral Development will be reviewed beginning at 7 p.m. Wednesday, June 25, at the institute in Suite 200 at 18600 Northville Road, Northville.

**● FREE HEALTH SCREENINGS**  
Free health screenings will be available 3-7 p.m. at Arbor Health Building, 990 W. Ann Arbor Trail at Harvey, Plymouth. Free screening tests will be offered for blood pressure, glaucoma, and hearing. Health risk appraisals will be available. For information, call 455-5869.

**● MENTAL HEALTH 'BUDDIES'**  
People who have been frequently hospitalized for mental health problems and are living in Plymouth, Canton, Northville, Livonia or Redford are eligible for a new "Buddies Program" for out-patient community mental health operated by Suburban West Community Center, 875 S.

Main, Plymouth, with main office at 11667 Beech Daly, Redford. Former clients who have demonstrated successful adjustment in the community serve as "buddies," providing assistance in handling crises and achieving personal goals. To receive further information about the program, call Suburban West Community Center, 937-9500 or 981-2665.

**● RED CROSS VOLUNTEERS NEEDED**  
Adult Red Cross volunteers are needed at St. Mary Hospital, Levan and Five Mile, Livonia. Day and evening hours are available for anyone interested in helping hospital personnel and patients. For information, call the Red Cross at 422-2787.

**● 'TELE-CARE'**  
Senior citizens in Plymouth-Canton may participate in a "Tele-Care" program in which telephone contact is made daily with senior citizens to check on their well-being. For more information, Canton residents may

call 397-1000, Ext. 278, and Plymouth residents may call 453-3840, Ext. 37, or 453-2671, Plymouth Township Hall.

**● PROBLEMS IN LIVING**  
Suburban West Community Center, a non-profit community mental health agency, has announced that its Problems in Living Clinic has limited money available to pay counseling costs for clients based on their ability to pay. Profits generated by client fees or insurance reimbursement are put into this fund to pay for those who cannot afford the full fee.

The Problems in Living Clinic provides outpatient counseling to adults and families for a wide variety of problems including anxiety and depression, marriage conflicts, fertility and adoption, parenting concerns, headaches and pain reduction, sexual functioning, communication, stress management, spouse and child abuse.

The clinic also provides services to adults who have been hospitalized or who are in crisis, based on ability to pay. The center has two locations, the main office at 11677 Beech Daly in Redford (phone 937-9500) or the satellite building in Plymouth at 875 S. Main (phone 981-2665).

**● COUNSELING, SELF-ESTEEM**  
Individual counseling and support groups are available on an ongoing basis to deal with lifestyle changes, depression, low self-confidence, assertiveness, divorce, job changes and general anxiety. People can work with these issues individually or in groups.

Major insurance coverages are accepted. Counseling and groups are run by an experienced and state-licensed social worker. Call Plymouth-Canton Mental Health Services at 459-6580 before 5 p.m. and ask for Sandy Prochazka.

**UNWANTED HAIR?**  
Be rid of it forever with Electrolysis  
- PAINLESS -  
All Work Done in Privacy  
Facial Hair • Underarms  
All Body Hair  
- FREE CONSULTATION -  
Hours by appointment to suit your busy schedule - Ask for Linda  
1180 W. Ann Arbor Rd.  
Headliners Between Main & Sheldon 455-4770  
HAIR STUDIO Plymouth

*Celebrate With Us*  
Sisters of Mercy serving our community since 1911

**CANTON TOWNSHIP PLANNING COMMISSION  
CHARTER TOWNSHIP OF CANTON  
NOTICE OF PUBLIC HEARING**  
**PROPOSED AMENDMENT TO THE ZONING ORDINANCE OF THE CHARTER TOWNSHIP OF CANTON, WAYNE COUNTY, MICHIGAN.**  
NOTICE IS HEREBY GIVEN pursuant to Act 184 of the Public Acts of Michigan, as amended, and pursuant to the Zoning Ordinance of the Charter Township of Canton that the Planning Commission of the Charter Township of Canton Township will hold a Public Hearing on Monday, July 14, 1986 at the Canton Township Administration Building, 1150 S. Canton Center Road at 7:30 p.m. on the following proposed amendments to the Zoning Ordinance.  
The proposed amendment to consent judgement and the site plan of their proposed development may be examined at Canton Township Administration Building, Mon.-Fri., 8:30 a.m. to 5:00 p.m.  
CONSIDER AMENDMENT TO MOCERI ET AL CONSENT JUDGEMENT TO PERMIT A SHOPPING CENTER KNOWN AS COVENTRY COMMONS EAST TO BE LOCATED ON THE SOUTHEAST CORNER OF JOY AND MORTON-TAYLOR ROADS.  
RICHARD KIRCHGATTER, Chairman  
Planning Commission  
Publish: June 23 and June 26, 1986

**NOTICE OF PUBLIC HEARING BEFORE THE TOWNSHIP BOARD OF THE CHARTER TOWNSHIP OF PLYMOUTH**  
**PROJECT PLAN FOR THE ECONOMIC DEVELOPMENT CORPORATION OF THE CHARTER TOWNSHIP OF PLYMOUTH FAIRWOOD WEST II PROJECT, INCLUDING ISSUANCE OF LIMITED OBLIGATION REVENUE BONDS**  
NOTICE IS HEREBY GIVEN that the Township Board of the Charter Township of Plymouth will hold a public hearing at 7:30 o'clock, p.m., in the Township Hall, 42350 Ann Arbor Road, in the Charter Township of Plymouth, Michigan, on the 8th day of July, 1986, on the issuance and sale of certain Bonds (identified below) and a Project Plan prepared by The Economic Development Corporation of the Charter Township of Plymouth (the "EDC") for its Fairwood West II Project (the "Project"), said Project being undertaken for the benefit of Fairwood West II, a Michigan co-partnership. The Project will be located on the west side of Haggerty Road, south of Ann Arbor Road, near the Standard Federal Savings & Loan, in the Charter Township of Plymouth, County of Wayne, State of Michigan.  
The Project Plan contemplates the issuance of not more than \$1,200,000 limited obligation economic development bonds (the "Bonds") by the EDC. The initial owner, operator and manager of the Project will be Angelo Spagnoli and William Spagnoli, the partners of the Company.  
The location of the Project Area and the Project District Area in relation to highways, streets, streams or otherwise is further described in a map on file with the Township Clerk.  
A description of the proposed Project Plan, including the method of relocating families and individuals (if any) who will be displaced from the area are available for public inspection at the office of the Township Clerk, located at 42350 Ann Arbor Road, Plymouth Township, Michigan, and all aspects of the Bonds and the proposed Project Plan will be open for discussion at the public hearing. The Project Plan contains additional information about the issuance of the Bonds and the financial parameters thereof. The Township Board will consider approval of (I) the Project Plan and (II) the Bonds only after the public hearing has been completed. The Township Board of the Charter Township of Plymouth shall provide an opportunity for interested persons to be heard and shall receive and consider communications in writing with reference to the hearing. The hearing shall provide the fullest opportunity for expression of opinion, for argument on the merits, and for introduction of documentary evidence pertinent to the Bonds and the proposed Project Plan.  
ESTHER HULAKING, Township Clerk  
Charter Township of Plymouth, MI 48137  
(517) 657-4881  
Publish: June 23, 1986

**"St. Joe's lets me give a little back."**  
Bob Lyons



The support of business leaders like Bob Lyons has played an important role in the history of St. Joseph Mercy Hospital. As volunteers, their talents, energy, and enthusiasm have helped shape today's Catherine McAuley Health Center.

"I like to remind people in the community that Catherine McAuley Health Center offers a wide spectrum of health care services. The Health Center works with businesses and the community at large to identify and meet health care needs.

"I especially like the Health Center's sensitivity to the community with projects like the neighborhood health clinic in Ypsilanti," adds Lyons, who serves on the clinic's Community Advisory Committee.

"I'm inspired by the spirit created by these giving people. As a volunteer, I am glad to have a chance to give a little back."

Since 1911, when the Sisters of Mercy were invited to this community, Catherine McAuley Health Center has evolved into a comprehensive health care center touching the lives of tens of thousands of families each year. We invite you to join us as we celebrate 75 years of health care service to the community.

For more information on the health care services of Catherine McAuley Health Center, please call 572-4000. For a physician referral, please call 572-5500.

Catherine McAuley Health Center  
5301 East Huron River Drive  
P.O. Box 998  
Ann Arbor, Michigan 48106  
313/572-3400

Bob Lyons has long been a dedicated supporter of St. Joseph Mercy Hospital.



# Sports

Chris McCosky, Brad Emons editors/591-2312



Monday, June 23, 1986 O&E

(P.C)1C

## Like a dream '86 Observer baseball team is a coach's ultimate fantasy

By Chris McCosky  
staff writer

ALL-AREA teams, like any other type of all-star collection, send coaches into dreamland: "What I would give to coach such a group just once." "Give me just three players off that team and see where we would finish."

Imagine, then, the wealth of fantasy the 1986 Observer All-Area Baseball Team conjures up.

The pitching staff combined for a 16-0 record. In 103 total innings, it yielded 12 earned runs, just 54 hits, posted 174 strikeouts and walked only 51.

The catcher has a strong arm and batted .450. The first baseman hit .408 and made just three errors all season. The rest of the infielders' averages were .483, .390 and .351. The five combined for 15 home runs and batted in 91 runs.

The outfielders had a combined batting average of .371 with 53 more RBI. The designated hitter contributed a .429 average, four homers and 20 RBI.

You can understand why they call such collections dream teams.

The desirable task of coaching this team goes to Westland John Glenn coach Norm Hoenes — Observerland's *Baseball Coach of the Year*.

The 20-year veteran coach took his team to the final four this season, winning the grueling Western Lakes as well as district and regional championships in Class A. His Rockets were 26-3 this year.

Let's take a look at the Observerland coaches' first-team selections.

Steve Irwin, Westland John Glenn, pitcher: Simply put, this senior was the most dominant pitcher in the area this season. Hoenes calls him the best pitcher he has ever coached. High praise, but statistics bear him out: Irwin was 16-4 over two years (10-0 this year) with a 1.86 ERA. In

### 1986 ALL-AREA BASEBALL SECOND TEAM

P—Chris Klooc	Thurston
P—Gary Scott	Wayne
C—Ed Drazinski	Borgess
1B—Dave Mondoux	Parkville
2B—Mackey Katschur	Chippewa
IF—Dennis Bushart	Redford Union
IF—Steve Abbernonie	Garden City
OF—Bob Mallock	Catholic Central
OF—Tim Dowd	Salem
OF—Kevin O'Connor	Thurston
DH—Vince Morin	Catholic Central

**HONORABLE MENTION:** Harrison: Ken George, Shawn Brennan, Jason Hicks; Farmington: Joe Bob Wenson, Steve Howell, Jim Howell; North Farmington: Todd Shepard; Salem: Steve Dawson, Mike Keason, Brian Tiller; Canton: Adam Koopik, Mark Stevens, Tom Kanyon, Mike Outter; Plymouth Christian: Jim McCarthy, Pat McCarthy, Jeff Leach, Todd Gentry; Franklin: Bob Soinikowski, Pao Chavez, Dave Drabicki, Ron Cortez, Mike Wozniak, Craig Diugos, Brad Norrid, Mike Greenyer; Churchill: Ken Gendler, Troy Isaacson; Stevenson: Dan Kraft, Joe Conway, Matt Russell; Redford Union: Pat Miller, Mike Stasiak; Thurston: Ron Rousseau, Dennis Laick, Brad Putter, Bishop Borgess; Keith Hubbell, Larry Platt, Mike Hestling; Park Goucher: Catholic Central: Tim Burke, Gil Garcia, Pat Nolan, Leo Hueston; St. Agatha: Marty Emory, Pat Knight, Jim Kaitel; Garden City: Brett West, John Sheridan, Jeremy Krot; John Glenn: Mike Hammon; Wayne: Ron Wey, Ken Droplewski, Joe Gossett.

65 innings this season, he fanned 122 batters and allowed but eight earned runs.

Irwin, who has accepted a full-ride scholarship to Eastern Michigan University, has a fastball clocked in the mid-80 mph range, but his out pitches are a paralyzing slider and a curve ball.

Joe Mukavetz, Garden City, pitcher: A good live fastball made this senior a consistent outmaker on the mound, a knuckleball made him outstanding. He was 15-2 in three years for the Cougars (6-0 this year) with a 1.13 ERA. He posted six career shutouts. In 38 innings this year, he fanned 52 and yielded but four earned runs.

Like Irwin, Mukavetz is a threat offensively. He batted .373 this season with 17 RBI.

Mike Rudin, North Farmington, catcher: If you wanted to design the perfect body for a catcher (and Lance Parrish was unavailable), you might want to use this guy. Strong and sturdy, Rudin caught full time for North for three years. In that time he batted .342 with 11 homers and 65 RBI. This year he hit .450 with three homers and 21 RBI.

Rudin, with an accurate arm and a quick release, was very tough to steal on.

Chris Sisler, Plymouth Canton, first base: The fact that he hit .370 over three years for the Chiefs is no surprise. His short, fluid stroke got his name in more than a few baseball scouting notebooks as early as his sophomore year. But the fact that he played virtually every game at first base this year and made but three errors is eye-opening. He was nicknamed Stone-paws in his junior year for his inability to catch the baseball.

To his credit, Sisler worked hard to become a complete player and is one of the best. He will play at Kansas City Community College next year.

Chris Tancill, Livonia Stevenson, infielder: A .483 batting average, four home runs, 18 RBI, a .900 slugging percentage (13 of his 29 hits went for extra bases) and an 18-game hitting streak to close out his career. Not bad for a hockey player.

Tancill, a superb athlete, has accepted a hockey scholarship from the University of Wisconsin. In three years at Stevenson, he batted .370 with seven home runs. He played catcher for two years, shortstop this year.

Please turn to Page 2

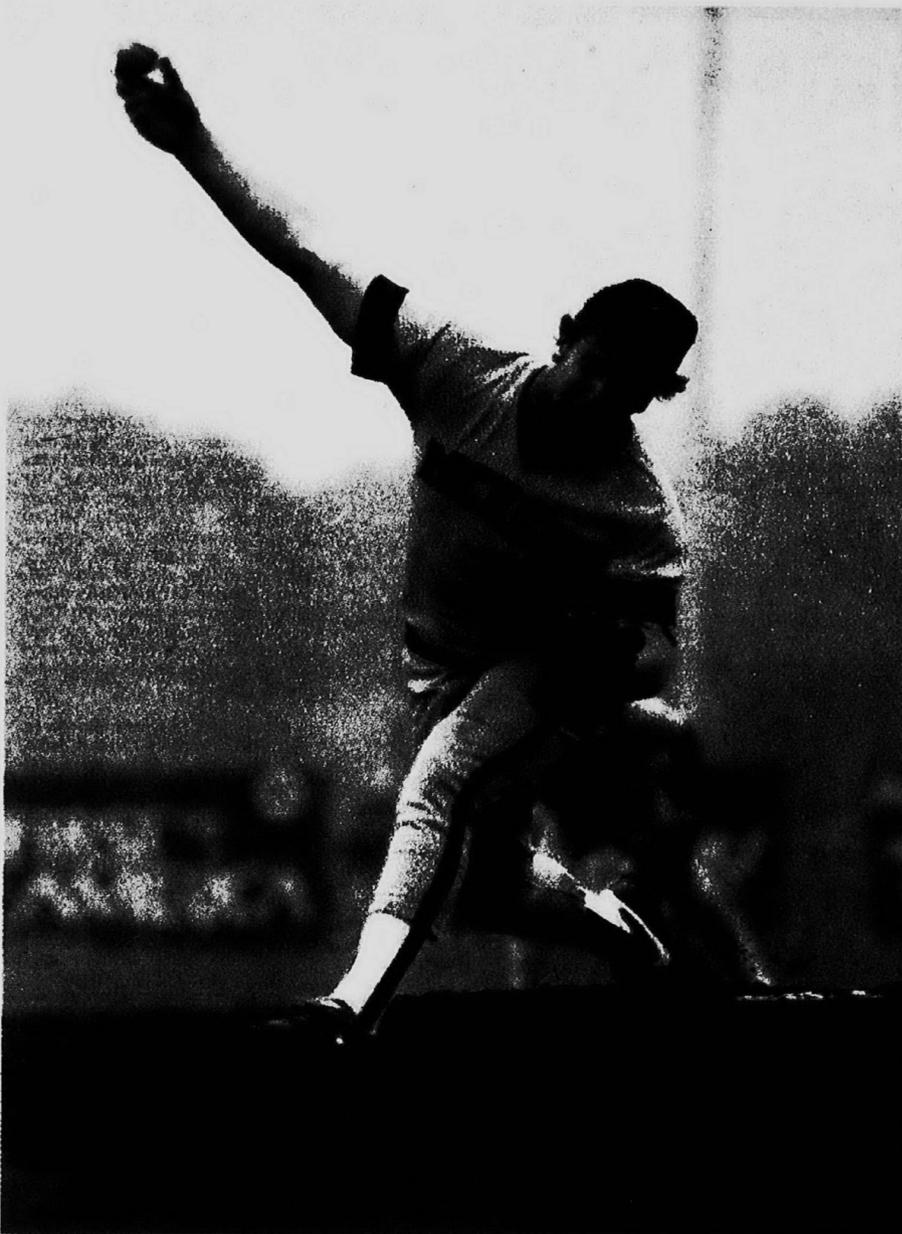

BILL BREBLER/staff photographer

Steve Irwin, with a live fastball and a paralyzing slider, was easily the area's most dominant pitcher. The John Glenn righty fanned 122 batters in 65 innings.

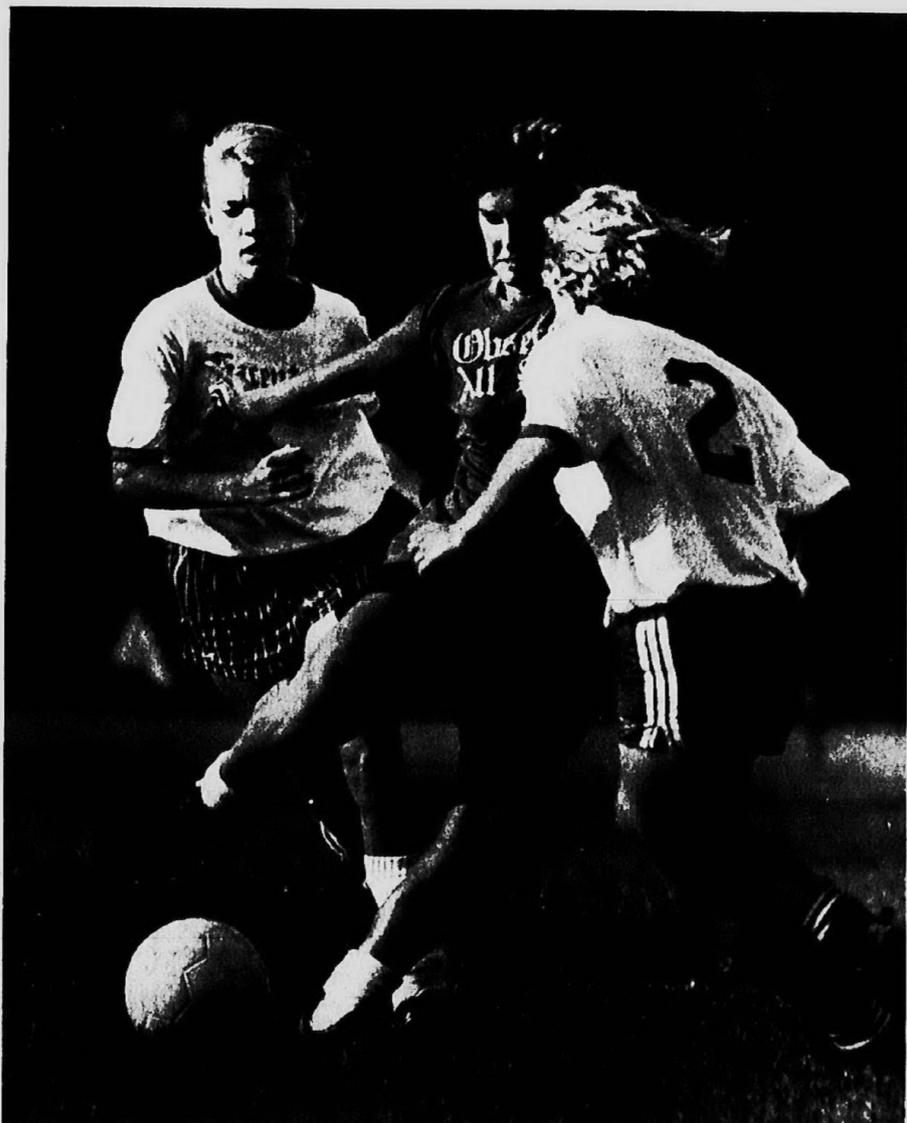

Observer star Jamie Kubacki from Livonia Churchill maneuvers past Eccentric stars Karen Denyer of Rochester (left) and Katy Andreae of Seaholm (right).

photos by GARY CASKEY/staff photographer

## One for the books Eccentric boots Observer, 4-2

By C.J. Rieak  
staff writer

### soccer

The talent gap is gone. Or maybe it's shifted locations. In Wednesday's fourth annual Observer & Eccentric girls All-Star Soccer Classic, the Oakland County Eccentrics ended three years of frustration and folly by dumping their Observer counterparts 4-2 at West Bloomfield High School.

When the first O&E Classic was staged four years ago, the talent gap was readily apparent in the Observers' 7-1 win. It remained visible in 1984 in Classic II, when the Observers again thumped their Eccentric foes 5-2.

Last year, the Eccentrics bolted to an early 3-0 lead against a flat Observer squad. The Observers proved their mettle by storming back from a 4-1 deficit to forge a 4-4 tie.

Don't think those past records didn't figure prominently while the Eccentrics prepared for Classic IV. Seniors like Katy Andreae of Birmingham Seaholm remembered the lopsided losses. And still vivid in many memories was last year's tie and the Eccentrics' inability to protect two three-goal leads.

More than once during Wednesday's game, Eccentrics coach Terry Dilworth (of Birmingham Marian) pointed to the scoreboard, which disclosed a 4-1 lead, and reminded his players, "This was the score when they came back last year, wasn't it?"

DILWORTH'S PRODDING wasn't necessary. As someone somewhere once said, that was then and this is now. By the midpoint of the second half, there was little doubt which was the better team. "I felt if we could apply a lot of pressure on the outside, it would open it up in the center," said Dil-

(Livonia Churchill), and with 27 minutes to play it was 3-1.

Six minutes later, the Eccentrics capitalized on the Observers pressuring offense to spring Wass. A long clearing pass from Kate Ferguson reached Wass behind the Observer defense, and her third goal put the game out of reach.

In the final minute of play, the Observers finally did beat Lynn Eckhout (Troy Athens), who was spectacular in the Eccentric nets, when Amy Stock (Farmington Hills Mercy) put a pass from wing Pelloni into the corner of the net.

IT DIDN'T make any difference. The Eccentrics victory was already assured.

"We had some chances," said Observer coach Ed Dudek (Livonia Churchill). "If we had put them in ..."

"Both teams were a bit nervous at the start. That's why the first goal made such a difference. They scored first and then could relax and play. We didn't capitalize on our offensive chances."

But to say the Eccentrics just scored first would be doing Wass and her teammates an injustice. The play, from its midfield start to Wass' high-kick finish, was superb. Andreae began it at midfield, clearing a pass into the right corner that stopped short of the end line.

Riemer beat Observer defender Marci Jamrog (Stevenson) to the ball and curled a perfect centering pass to Wass, who wheeled around to boot the ball at shoulder level into the net.

"That was a super play by Cindy," acknowledged Dudek.

Wass' second goal was more conventional, but on the same type of play as her first. Again, Riemer beat Jamrog to the ball in the corner and

Observer goalkeeper Liz Monroe

Please turn to Page 2

# 1986 All-Area baseball squad



Steve Irwin John Glenn Joe Mukavetz Garden City Mike Rudin N. Farmington Chris Sisler Canton Rick Tavormina John Glenn

## Irwin tops All-Area team

Continued from Page 1

**Rick Tavormina, Westland John Glenn, infielder:** The only junior on this senior-laden squad, Tavormina was the trigger to Glenn's offense. He batted .390, knocked in 25 runs and scored 15.

He was also valuable from a defensive point of view. He demonstrated excellent range and a strong arm from his shortstop position.

**Brian Smolinski, Farmington Harrison, infielder:** If you doubt that this was the most dangerous hitter in the area, check out this stat: he was walked 19 times this year, 44 times in his career. That's getting pitched around an awful lot.

He hit .375 in his career, with 15 homers. He also stole 40 bases. This year he batted .351 with five homers. He has hit some tape-measure blasts in his time. He once drove one high off the house that hits a good ways beyond the right field fence at North Farmington.

**Brian Song, Livonia Stevenson, outfielder:** Probably the best defensive outfielder in Observerland (although the next two men on this list are no slouches.) He has taken away many an extra base hit with his rabbit-like quickness.

He hits well, too. He batted .395 this year with 16 RBI from his lead-off position. He scored 24 runs and was 13-for-13 stealing bases.

**Tony Aiken, Plymouth Canton, outfielder:** Another well-schooled defensive player, with an intangible — he is a team leader. He played center field and batted leadoff for the Chiefs. When he was on, so were the Chiefs.

He owns a .320 career average at Canton. This year, he batted .362, knocked in 18 runs and scored 23.

**Chuck Hammontree, Westland John Glenn, outfielder:** It is doubtful that a ball would ever drop against this All-Area outfield. Hammontree didn't make an error all season.

He also made very few mistakes at the plate. He batted .361 with 19 RBI and 14 stolen bases.

**Trent Hiner, North Farmington, designated hitter:** This senior might have the worst-looking swing of anyone — but who can argue with the results. He batted .429 with four home runs and 20 RBI. He gets an awful lot of power out of his 5-9, 165-pound frame.

His on-base percentage this year was .552. Who cares what the swing looks like?



Brian Smolinski Harrison Chris Tancill Stevenson Brian Song Stevenson Tony Aiken Canton Trent Hiner N. Farmington Chuck Hammontree John Glenn

## Wendt, Briggs to get pro shot

By Brad Emons staff writer

The glitter of New York's bright TV lights focused in on some of the nation's top collegiate players Tuesday as the National Basketball Association (NBA) held its annual draft.

The expected first-round picks were flown in, wine and dined, and put on display for a national TV audience. Going on parade were such notables as North Carolina's Brad Daugherty, Maryland's Len Bias and North Carolina State's Chris Washburn, the top three picks in this year's draft.

Far away from the hoopla and not part of the Madison Square Garden proceedings were two area products, Greg Wendt of the University of Detroit and former Schoolcraft College scoring ace Carlos Briggs.

Both, however, were pleased to be included in the NBA selection process.

Briggs, a 6-foot guard who played only eight games this season at Baylor after being suspended by the

NCAA and ultimately being dumped from the squad by first-year coach Gene Iba, was pleasantly surprised to learn that he had been taken in the fourth round, the 79th pick overall, by the San Antonio Spurs.

WENDT, who prepped at Redford Catholic Central High and played for two seasons at Duke before finishing his career at U-D, was taken by the world champion Boston Celtics in the sixth round.

The 6-foot-6 Wendt, currently playing for the Gold Coast (Fla.) Stingrays of the U.S. Basketball League, got the news Tuesday evening via phone from his parents in Livonia.

"I was confident I'd go somewhere in the draft," said Wendt from his motel room in West Palm Beach. "I'm happy. I'm looking at it this way — they're giving me an opportunity to play and I'm going to give it my best shot and see what happens. I'm looking at it positively."

Wendt's stock may have risen during the past few weeks after he im-

### basketball

pressed Gold Coast coaches in training camp. Earning a starting job on a team which includes LSU's Don Redden, Wendt scored 27 and 28 points in his first two games. The U.S.B.L., a seven-team east coast summer basketball circuit, helped spawn a pair of NBA prospects last summer — 5-foot-6 guard Spud Webb of the Atlanta Hawks and 7-6 center Manute Bol of the Washington Bullets.

"I've started out real well and that may be a factor," said Wendt. "Maybe it's given me more exposure."

"I'M MAKING decent money, but you won't get rich. But it's a stepping stone to the NBA. I'm playing basketball, getting a tan, having a good time and working hard. I'm playing the game that I've always enjoyed."

"I can't complain." Briggs, meanwhile, was also elated when he heard the news late Tuesday afternoon from a Waco, Texas, sportswriter.

"I'm really excited," Briggs said. "It's a good accomplishment since I only played eight games this year. I was worried about the fact that I might not go at all because of all what happened down here."

As a junior, Briggs finished second in the Southwest Conference in scoring averaging 20.4 points per game.

But near the end of his first season at Baylor, coach Jim Haller resigned in the wake of NCAA recruiting violations.

Iba then took over in the midst of NCAA sanctions in which Briggs and six other Baylor players were slapped with a series suspensions in early January, ranging from three to nine games.

Briggs and fellow senior co-captain B.J. Mitchell, were both told by the NCAA to sit out nine games. While both players were serving NCAA suspensions, the new Baylor coach dismissed the two for reasons he chose not to disclose to the press.

## Kick classic had a talent balance

NOTES, QUOTES, ANECDOTES from Wednesday's O&E girls soccer All-Star Classic:

• There's little doubt the level of soccer talent in all areas has risen. In Wednesday's Classic IV, no single player truly dominated, unlike past games in which players like Mary Kay Hussey of Livonia Stevenson and Annette Ruggiero of Farmington Hills Mercy were far superior to many of the other stars.

The reason isn't so much a lack of players of that caliber. Rather, the depth of talent has swelled. There are more good players than ever.

Those in attendance at Classic IV need no further convincing. Much of the audience marveled when, during the first half, a half-dozen stars touched the ball in succession without it ever touching the ground.

• The game was a resounding success in many respects. A new O&E Classic record for attendance was established: 343, breaking the 1984 mark of 336. The record crowd saw the Eccentrics end the Observers' domination of the series with a 4-2 victory.

But there is doubt regarding the Classic's future. The Michigan High School Athletic Association currently has a rule forbidding high school athletes from competing in all-star contests. Those that do cannot compete in high school athletics their next semester.

So far, that rule applies only to football, basketball and hockey players. But the MHSAA is considering expanding it to cover all high school sports, which would doom the O&E Classic.

• Dilworth insists he has a nomination for MVP: Most Valuable Supporter. It's the guy who suffered the most in the early years of the Classic, according to Dilworth, when the Observers were dominating: former Troy-Rochester sports editor Jim Hughes. "You should change the name to the Jim Hughes Classic," Dilworth suggested after the Eccentrics' victory.

• Our thanks to Roger Faulkner and Gordon Preston, former owners of the Detroit Express pro soccer team, who graciously presented the awards to the O&E stars after Classic IV.

Also, our thanks to the West Bloomfield Community Education Department and West Bloomfield High School athletic director Jim Feldkamp for use of the field, to referees Norm Parsons and Tom Montroy, to athletic trainer Bill Watson, and to announcer Rich Lech, the "Classic voice."

And last but not hardly least, many thanks to Eugene and Bryce, who volunteered their legs and hustle in chasing down balls that rolled out of bounds. Word has it each received MVP consideration.

## Eccentric kickers win 1st O&E classic

Continued from Page 1

centered it perfectly. Wass' task was easy.

THE ATHENS junior's hat trick matched the O&E Classic record for goals in a game, set by Mary Kay Hussey (Stevenson) in 1983. It also magnified her importance to the team. In Classic III, Wass was hurt early and played sparingly. Her absence was sorely felt in the 4-4 tie.

Not that the Eccentrics couldn't have won without her Wednesday.

They were faster than their Observer counterparts and far more determined.

"This game really means something to these players," said Dilworth. "They really want to win it. Most all-star games are showcases for individual talents, but these girls submerged their individual abilities. They all had that common goal, to win the game."

Dilworth remembered all too well the superior talent the Observer team displayed early in the series. He figures it's evened up now.

## Caesars edge Adray

Little Caesars remains in a virtual tie with Tom Holzer Ford atop the Livonia Collegiate Baseball League thanks to some extra-inning heroics from Rob McCamant.

McCamant, a Livonia Clarenceville-Aquinas College product, lashed a Rick Rozman pitch over the left field fence at Capitol Park in the bottom of the eighth inning Wednesday to give Caesars a 4-3 win against Livonia Adray.

The win pushed Caesars record to 7-3-1; Adray falls to 7-4. John Poszywak's two-run double keyed a three-run fourth inning to give Adray a 3-2 lead.

Caesars tied the game in the bottom of the seventh. Tyrone Gaines singled and stole second. He scored

### baseball

on Bob Czapl's base hit. Tom Liss, who pitches for Walters State Community College in Tennessee, scattered four hits over the eight innings to record the victory. He struck out 10 Adray hitters.

Liss was aided by several sterling defensive plays by shortstop Mike Kocinski.

Rozman, the Michigan State-via-Livonia Stevenson right-hander, yielded seven hits and fanned five. He was victimized by four Adray errors.

IS THE GLASS IN YOUR WINDOWS FOGGED • CONDENSED • STAINED • WE'RE OFFERING 20% OFF REGULAR PRICE THERMOPLASTIC INSULATED GLASS REPLACEMENT 522-4440

**PANIC ATTACKS** Lafayette Clinic is doing research with people who suffer from PANIC ATTACKS. The symptoms include: palpitations, faintness, sweating, dizziness, choking sensations, fear of dying or going crazy during an attack, tingling in the hands or feet, etc. If you have episodes of the above, you may be eligible for the study. FREE TREATMENT is available to participants. Please ask for ANXIETY DISORDERS PROGRAM. LAFAYETTE CLINIC 256-9569 Mon.-Fri., 8 A.M.-4 P.M.

**COMPANY & TEAM HATS** YOUR LOGO \$2.95 3 DOZ. MIN. ART EXTRA OFFICIAL 533-9552 SPORTS CENTER

**REUPHOLSTERING SALE** FREE Arm Covers Sofas from \$249\*\* Chairs from \$149\*\* Kitchen & Dining Chairs from \$19.95 5 Day Service Available 10% Discount to Senior Citizens Check Our Prices on Carpeting and Plastic Covers ALL Work Guaranteed FREE In-Home Estimates 836-8900

**'Ill' tan barn do-it-yourself and save** roof trusses all assembled choice of shingle color with wood floor includes all hardware wood siding plus batten strip 8' x 10' \$321.45 plus tax 10' x 12' Also Stocked other siding options available

**SEPCO OXFORD BATH FAUCET** #2501 WIDESPREAD POLISHED BRASS \$99.95 Reg. \$178.20

**"The Villager"** BERTCH CABINET 2411 3 DRAWER \$239 Reg. \$338 SAVE \$100\*\* With 22" Marbleite Top Enhances the fine quality of this bathroom furniture.

**SEPCO MANHATTAN BATH FAUCET** #491 POLISHED BRASS \$99.95 Reg. \$148.00

**COMFORT SPECIAL!** Be comfortable. Improve your home environment by cleaning and freshening the air with a Space-Gard air cleaner. Efficiently removes pollen, dust, dirt and other irritating air pollutants. Space-Gard uses no electricity. Requires no maintenance. And the price is comfortable too. Space-Gard AIR CLEANERS SAVE \$40.00 \$129.95 Reg. \$169.95

**DID YOUR AIR CONDITIONER DIE LAST SEASON — OR — COST TOO MUCH TO OPERATE?** We can replace your outdoor unit From \$749.95 1 1/2 Ton installed to your existing indoor coil. 38 EH018 Giving You Comfort And Low Operating Cost.

**DO-IT-YOURSELF CARRIER FURNACE \$359.95** Reg. \$638 75,000 BTU 58G8075-101 Electronic Spark Ignition Other Models Available at Comparable Savings

**THE BEST SELECTION IN TOWN** AMERICAN STANDARD BERTCH CABINETS ELJER KOHLER MOEN CARRIER PEDESTAL LAVATORY 17x22 Vitreous China RIO White \$99.00 Reg. \$169.50 STEEL OVAL SINK White Reg. \$42.10 \$22.95

**DON'T GET IN OVER YOUR HEAD. RELAX AND ENJOY! LET BERGSTROM'S DO IT RIGHT!**

**KOHLER BRAVURA LAV FAUCET** Polished Chrome 10847 Reg. \$209.00 \$189.00 **KOHLER KITCHEN SINK** Reg. \$119.00 \$149.00

**BERGSTROM'S PLUMBING - HEATING - COOLING TWO SALES & SERVICE CENTERS FOR YOUR CONVENIENCE**

**Donate Blood.** C.H. SALES INC. 38472 Ford Road Canton, Michigan Express June 30, 1986

# CLASSIFIED HOME FINANCING

## REACH MICHIGAN'S FINEST MARKET

644-1070 Oakland County 591-0900 Wayne County 522-3222 Rochester/Rochester Hills



### YOU MAY PLACE A CLASSIFIED ADVERTISEMENT FROM 8:00 A.M. - 5:30 P.M. MONDAY - THURSDAY AND FROM 8:00 A.M. - 5:00 P.M. FRIDAY

### EQUAL HOUSING OPPORTUNITY

All advertising published in the Observer & Evening News is subject to the conditions stated in the applicable rate card, copies of which are available from the Advertising Department, Observer & Evening News, 2000 F. Schaefer Road, Troy, MI 48063. (313) 525-2500. The Observer & Evening News does not discriminate in advertising contracts on the basis of race or sex. Any provision in any order or agreement for advertising that purports to discriminate on the basis of race or sex, even if handwritten, typed, or otherwise made a part of a particular contract, is hereby rejected.

## INDEX

### REAL ESTATE FOR SALE

- 302 Birmingham-Bloomfield
- 303 West Bloomfield
- 304 Farmington-Farmington Hills
- 305 Brighton-Brighton
- 306 Southfield-Lathrup
- 307 Milford-Hartland
- 308 Rochester-Troy
- 309 Royal Oak-Oak Park
- 310 Huntington Woods
- 311 Commerce-Cleon Lake
- 312 Orchard Lake-Walled Lake
- 313 Livonia
- 314 Dearborn-Deborn Heights
- 315 Plymouth-Canton
- 316 Northville-Novi
- 317 Westland-Garden City
- 318 Grosse Pointe
- 319 Redford
- 320 Homes for Sale-Oakland County
- 321 Homes for Sale-Wayne County
- 322 Homes for Sale-Macomb
- 323 Homes for Sale-Washtenaw County
- 324 Other Suburban Homes
- 325 Real Estate Services
- 326 Condos for Sale
- 327 Duplex for Sale
- 328 Townhouses for Sale
- 329 Apartments for Sale
- 330 Mobile Homes for Sale
- 331 Northern Property
- 332 Out of Town Property
- 333 Time Share
- 334 Florida Property for Sale
- 335 Farms for Sale
- 336 Country Homes
- 337 Lots & Acreage
- 338 Lake/River/Resort
- 339 Property for Sale
- 340 Lake Property
- 341 Cemeteries/Lots
- 342 Business & Professional Buildings for Sale
- 343 Investment Property for Sale
- 344 Mortgages/Land Contracts
- 345 Business Opportunities
- 346 Money to Loan
- 347 Real Estate Wanted
- 348 Listings Wanted

### REAL ESTATE FOR RENT

- 400 Apartments to Rent
- 401 Furniture Rental
- 402 Furnished Apartments
- 403 Rental Agency
- 404 Houses to Rent
- 405 Property Management
- 406 Furnished Houses
- 407 Mobile Homes
- 408 Duplexes to Rent
- 409 Flats to Rent
- 410 Townhouses/Condominiums
- 411 Time Share

### EMPLOYMENT, INSTRUCTION

- 500 Help Wanted
- 502 Help Wanted-Dental Medical
- 504 Help Wanted-Office Clerical
- 505 Food-Beverage
- 506 Help Wanted Sales
- 507 Help Wanted Part Time
- 508 Help Wanted Domestic
- 509 Help Wanted Couples
- 510 Sales Opportunity
- 511 Entertainment
- 512 Situations Wanted Female
- 513 Situations Wanted Male
- 514 Situations Wanted Male/Female
- 515 Child Care
- 516 Summer Camps
- 518 Education Instructions
- 519 Nursing Care
- 520 Secretarial Business Services
- 522 Professional Services
- 523 Attorneys/Legal Counseling
- 524 Tax Services

### ANNOUNCEMENTS

- 600 Personals (your discretion)
- 601 Lost & Found (by the word)
- 602 Health, Nutrition & Weight Loss
- 603 Announcements/Notices
- 604 Legal Notices
- 605 Insurance
- 606 Transportation/Travel
- 607 Carrot of Thanks
- 612 In Memoriam
- 614 Death Notices

### MERCHANDISE

- Bus 700 Auction Sales
- Bus 701 Collectibles
- Bus 702 Antiques
- 703 Crafts
- 704 Magazine Sales/Flea Markets
- 705 Wearing Apparel
- 706 Garage Sale-Oakland
- 707 Garage Sale-Wayne
- 708 Household Goods-Oakland
- 709 Household Goods-Wayne
- 710 Misc for Sale-Oakland
- 711 Misc for Sale-Wayne
- 712 Appliances
- 713 Bicycles-Sale & Repair
- 714 Business & Office Equipment
- 715 Computers/Service

### ANIMALS

- 738 Household Pets
- 740 Pet Services
- 744 Horses, Livestock, Equipment

### AUTOMOTIVE/TRANSPORTATION

- 800 Recreational Vehicles
- 802 Snowmobiles
- 804 Airplanes
- 805 Boats/Motors
- 807 Boat Parts & Service
- 808 Vehicle/Boat Storage
- 810 Insurance, Motor
- 812 Motorcycles, Go-Karts, Minibikes
- 813 Motorcycles, Parts & Service
- 814 Campers/Motorhomes/Trailers
- 816 Auto/Trucks, Parts & Service
- 818 Auto Rentals Leasing
- 819 Auto Financing
- 820 Autos Wanted
- 821 Junk Cars Wanted
- 822 Trucks for Sale
- 823 Vans
- 824 Jeeps/4 Wheel Drive
- 825 Sports & Imported
- 852 Classic Cars
- 854 American Motors
- 856 Buick
- 858 Cadillac
- 860 Chevrolet
- 862 Dodge
- 866 Ford
- 872 Lincoln
- 874 Mercury
- 876 Oldsmobile
- 878 Plymouth
- 880 Pontiac
- 884 Volkswagen

### BUSINESS DIRECTORY SERVICES

- 3 Accounting
- 4 Advertising
- 5 Air Conditioning
- 6 Aluminum Cleaning
- 9 Aluminum Siding
- 10 Antennas
- 12 Appliance Service
- 13 Aquarium Service
- 14 Art Work

### Asphalt

- 15 Asphalt
- 16 Asphalt Seacoating
- 17 Auto Clean-up
- 18 Auto & Truck Repair
- 21 Awnings
- 22 Barbecue Repair
- 23 Basement Waterproofing
- 25 Bathroom Refinishing
- 26 Bicycle Maintenance
- 27 Brick, Block & Cement
- 29 Boat Docks
- 30 Bookkeeping Service
- 32 Building Inspection
- 33 Building Remodeling
- 36 Burglar Alarm
- 37 Business Machine Repair
- 39 Carpentry
- 42 Carpet Cleaning & Dyeing
- 43 Carpet Laying & Repair
- 45 Catering-Flowers
- 53 Caulking
- 54 Ceiling Work
- 55 Chimney Cleaning
- 56 Chimney Building & Repair
- 57 Christmas Trees
- 58 Clock Repair
- 59 Commercial Steam Cleaning
- 60 Construction Equipment
- 61 Dry Cleaning/Laundry
- 62 Doors
- 63 Draperies
- 64 Dressing & Tailoring
- 65 Drywall
- 66 Electrical
- 67 Electrolysis
- 68 Energy/Conversions
- 69 Excavating
- 70 Exterior Caulking
- 72 Fences
- 75 Fireplaces
- 76 Fireplace Enclosures
- 78 Firewood
- 81 Floor Service
- 87 Floodlight
- 90 Furnace Repair/Installation
- 93 Furniture Finishing & Repair
- 94 Glass-Block, structural, etc.
- 95 Glass-Stained-Beveled
- 96 Garages
- 97 Golf Club Repair
- 98 Greenhouses
- 99 Gutters
- 102 Handyman
- 105 Hauling
- 108 Heating & Cooling
- 109 Solar Energy
- 110 House Cleaning
- 111 Home Safety
- 112 Humidifiers
- 114 Income Tax
- 115 Industrial Service
- 116 Insurance Photography
- 117 Insulation
- 120 Interior Decorating
- 121 Interior Space Management
- 123 Janitorial
- 124 Jewelry Repairs & Clocks
- 129 Landscaping
- 132 Lawn Mower Repair
- 135 Lawn Maintenance

### 136 Lawn Sprinkling

- 142 Linoleum
- 145 Management
- 146 Marble
- 148 Mobile Home Service
- 150 Moving-Storage
- 152 Mirrors
- 155 Music Instruction
- 157 Music Instrument Repair
- 158 New Home Services
- 165 Painting-Decorating
- 166 Party Planning (Flowers, Food, Service)
- 170 Pesticide
- 175 Pest Control
- 178 Photography
- 180 Piano Tuning-Repair-Refinishing
- 200 Plastering
- 216 Plumbing
- 219 Pool Water, Delivery
- 220 Pools
- 221 Porcelain Refinishing
- 222 Printing
- 223 Recreational Vehicle Service
- 224 Retail Hardwoods
- 225 Refinishing
- 226 Refrigeration
- 233 Roofing
- 234 Scissor, Saw & Knife Sharpening
- 235 Screen Repair
- 237 Septic Tanks
- 241 Sewer Cleaning
- 248 Sewing Machine Repair
- 249 Slipcovers
- 250 Solar Energy
- 251 Snow Blower Repair
- 255 Stucco
- 257 Swimming Pools
- 260 Telephone Repair
- 261 TV, Radio & CB
- 262 Tennis Courts
- 266 Terrariums
- 269 Tile Work
- 273 Tree Service
- 274 Truck Washing
- 275 Typing
- 277 Typewriter Repair
- 278 Upholstery
- 279 Vacuums
- 280 Vandalism Repair
- 281 Video Taping Service
- 282 Vinyl Repair
- 283 Ventilation & Attic Fans
- 284 Wallpapering
- 285 Wall Washing
- 287 Washer/Dryer Repair
- 288 Water Softening
- 289 Welding
- 294 Well Drilling
- 296 Window Treatments
- 297 Windows
- 298 Woodworking
- 299 Woodburners

### 312 Livonia

**A CASTLE GARDENS**  
lovely 3 bedroom brick ranch, 1 1/2 baths, family room/natural fireplace, finished basement, 2 car garage, fenced lot with mature landscaping, system. New custom oak kitchen & 1/2 bath. New floor coverings throughout. Many extras. Call 464-1846  
By Appointment, 464-1846

**A VERY NICE FAMILY HOME**  
In Popular Sub. Three bedrooms, master bath & second bath. Country kitchen with breakfast room, dining room, 2 1/2 car garage. \$86,900. Call 563-8700  
**Thompson-Brown**

**BEAUTIFUL**  
3 bedroom brick ranch features 2 1/2 baths, lovely also dining room, finished basement, 2 car attached garage. \$124,900.

**CENTURY 21**  
Hartford South-West  
348-6500 437-4111

**BEAUTIFUL 4 bedroom** wood level livonia, family room, formal dining room, formal living room, 2 car attached garage, professionally landscaped, many extras, \$123,000. 591-9870

**BY OWNER - FIVE & NEWBURGH**  
4 bedroom, 2 1/2 baths, colonial. Formal dining room, family room/fireplace, basement, attached garage, fully carpeted. Lots of other moulding, antique french door with large glass. Large corner lot, deck. \$113,500. For appointment, 464-2046

**BY OWNER - Windridge Village colony**  
3 large bedrooms, living room, dining room, family room with fireplace, 2 1/2 baths, occupancy upon completion of new home. \$156,500. 478-1826

**BY OWNER, 11865 Inlander Dr.**  
2 bedrooms, 1 1/2 baths, new furnace, kitchen, carpet throughout. \$32,800. 525-7817

**BY OWNER, 14124 Richfield, 4 bedroom**  
brick colonial, 2 1/2 baths, 1st floor laundry, large lot. \$129,000. fenced, trees. Large lot. 464-2425

**BY OWNER, 2100 sq. ft. Quad**  
4 bedrooms, 2 1/2 baths, air, security system, in-ground garage, pool, 2 1/2 car garage, 1535,000. Open Sun. 2-4. 853,500. 464-4482

### 312 Livonia

**LIVONIA & AREA**  
**LIVONIA - THE ONE!** A unique Livonia Cape cod, built in 1938 with 2 bedroom down and an upstairs living room of 30x20 with fireplace & wet bar. Home has a formal dining room & Florida room, all plus almost 2 acres of tree land with orchard and 2 car garage with work area. Room for your ideal Asking \$134,900. (L15GR0)

**REDFORD-MUST SEE** Charming 3 bedroom S. Redford brick ranch, decorated very tastefully with earth tone colors, remodeled kitchen, enclosed front porch, basement, aluminum trim, 1st floor laundry, great area. \$49,900. Won't last! (L01BER)

**GARDEN CITY-LOVELY AND WAITING FOR YOU!** 3 bedroom brick ranch in mint condition and tastefully decorated. Remodeled bath with oak vanity, newer triple aluminum window. Scaled summer room, extra insulation, 2 1/2 car garage and all cement approximately 3 1/2 years old. Large lot. \$54,900. (L0BDEE)  
**Schwitzer Real Estate**  
Better Homes & Gardens  
522-5333

**LIVONIA & AREA**  
**NEW CONSTRUCTION** Exciting design located on a prime Livonia 1/2 acre wooded lot. Three bedroom brick ranch with great room, natural fireplace, 2 full baths, first floor laundry, basement, and 1st car attached garage. Call 291-5800

**NEW HORIZONS** Await your in your first home. Excellent opportunity to invest in a secure future in this North Livonia 3 bedroom brick ranch. Full basement, aluminum trim, central air and kitchen appliances. Immediate occupancy. \$42,900.

**SECOND CHANCE** Unfortunate circumstances have just put this hot Westland brick ranch back on the market. 1400 square ft. 3 bedroom offering a spacious family room with fireplace, 2 1/2 bathrooms, finished basement wood deck, 2 car attached garage and plush new carpet throughout. \$94,900.

**JUST LISTED** Fantastic investment or starter home on a street of high priced well kept homes. Garden City brick ranch, 3 bedrooms, 2 1/2 baths, central air and kitchen appliances. Call 291-5800

### 312 Livonia

**LIVONIA & AREA**  
**PRIME LOCATION** This Northwest Livonia 4 bedroom brick colonial has it all. 2 1/2 baths, 1st floor laundry, family room with natural fireplace, formal dining room & 2 car attached garage. \$107,500.

**BLUE RIBBON** Amenities abound in this sparkling brick bungalow in a meticulous Western Redford brick subdivision. 3 bedrooms, basement, formal dining room and attached garage. \$65,900.

**1-98 LOCATION** The perfect environment for raising your family or enjoying your retirement. Brick 3 bedroom ranch home offering 1 1/2 baths on the first floor, finished basement, central air and attached garage. Immediate occupancy. \$99,900.

**WHITELY CLEAN** First impressions are lasting ones in this 3 bedroom brick bungalow. Nestled tree lined street in Western Redford and featuring 1 1/2 baths, basement, aluminum trim, 1st floor laundry, and garage. FIRST OFFERING! \$49,900.

**HARRY S.**

**WOLFE**  
421-5660

### 314 Plymouth-Canton

**FAMILY ROOM**  
3 bedroom ranch, remodeled kitchen & bath, large living room & family room, formal dining room, Best Value in Plymouth - at \$55,900.

**CENTURY 21**  
Hartford South 261-4200

**Investor's Dream**  
Plymouth's older village, which is an excellent location for small business. 1st story is retail, 2nd story has a formal dining room, great room/living room, 2 car garage, potential entrance in rear, 12 x 21 wood deck, apartment 12 x 20. Call:

**DENISE BORG**  
**CENTURY 21**  
Gold House Realtors  
420-2100 464-8881

**Newly Decorated**  
3 bedroom ranch - has fireplace in living room, 2 full baths, 2 car garage for only \$63,900.

**Here's A Deal**  
3 bedroom colonial with family room, wood deck, 1 1/2 baths, full basement and attached garage. \$78,000. Call:

**JOAN ANDERSEN**  
Century 21  
Gold House Realtors  
458-6000

**N. CANTON**  
Extremely well kept 3 bedroom wood. Large country kitchen with pantry & extra cupboards, country style kitchen, large lot, landscaped garden, overruns lot & much more. The best in suburban living. \$98,000. 591-5024

**N. CANTON, By owner, 4 bedroom**  
colonial, dining room, fireplace, patio, basement, under family room, Open Sun. 1-9pm. 453-3422

**PLYMOUTH by owner, 2 bedrooms,**  
\$64,900. Large living room, fireplace, fenced yard, double lot, call 420-1101. 420-1101

**(Northville Rd., S of S Mill), Shown**  
by appointment.  
Home: 453-2699 Work: 463-4296

**PLYMOUTH by owner, 3 bedrooms,**  
great room, natural stone fireplace, 2 car garage on large lot. All appliances included. \$84,900. 1-888-1169

**PLYMOUTH - TRAILWOOD**  
By owner, Ranch, 3 bedrooms, 2 1/2 baths, living/dining room, basement family room with built-in bar, fireplace. Large kitchen with oak planing area, 1st floor utility room, attached garage with automatic door opener, 12 x 12 cedar storage deck, raised porch with grapevine covered lattice sides, in-ground pool, large lot, landscaped, home. \$148,900. By appointment. 458-2895

**PLYMOUTH TWP. - By Owner, Well**  
kept 2 bedroom, laundry room, open concept living room with fireplace, large lot. Buyers only \$49,900. Ask for Teri Davis: 425-6499 458-5885

**PLYMOUTH - well to town, neat, 3**  
bedroom, 1 1/2 baths, 2 car garage, finished basement, brick ranch, aluminum siding, fresh paint, lots of storage. Excellent condition. Must see! Home: 453-2699 Work: 463-4296

**PLYMOUTH - 3 bedroom, fresh**  
carpet, 1 1/2 baths, 1st floor laundry, 2 car garage, 1st floor laundry, 2 car garage, 1st floor laundry, 2 car garage. Call 458-2895

### 316 Westland Garden City

**ADD YOUR OWN TOUCHES**  
To this N. Garden City 3 bedroom bungalow with modern kitchen, separate dining, family room with bay window, 2 car garage. \$40,500.

**WILL TIPTON**  
427-5010

**A LOT FOR A LITTLE**  
Immaculate, move-in condition 3 bedroom with large country kitchen, formal dining room, great room/living room, 2 car garage, full basement, plenty of cabinets, 2 1/2 baths, huge basement, many extras in this custom ranch home. Call to see or write. \$76,000. Call:

**NOEL or LEE BITTINGER**  
Century 21  
Gold House Realtors  
459-6000

**A Real Beauty**  
In this 3 bedroom brick and limestone ranch located in Westland. Carpeted throughout, new decor, full basement, garage, fenced yard, clean and neat - move right in. Asking \$47,900.

**PAT DELUCA**  
**CENTURY 21**  
Gold House Realtors  
420-2100 464-8881

**BY OWNER - GARDEN CITY**  
4 bedroom, aluminum sided, finished basement, 2 car garage, 12 x 24 deck, 17 x 35 corner fenced in-ground pool. Quick occupancy. \$89,900. 425-1106

**BY OWNER, 3 bedroom brick ranch,**  
\$99,900. Shown by apt. 477-6729

**GARDEN CITY - Open Sun, 1-4**  
2000 Helen, 4 rooms, utility room, 2 baths, garage, paved streets. \$40,900. 477-7899

**GARDEN CITY - 3 bedroom colonial,**  
2 1/2 baths, 2 car garage, finished basement, 1st floor laundry, fireplace. \$74,900. 421-3025

**IMMEDIATE OCCUPANCY 3 bedroom**  
ranch, family room, 2 car garage. SIMPLE! Assumption 3 bedroom ranch. Finished basement, central air, Call Rich at Metro West 261-8484

**INVESTORS TAKE NOTE** of this cute home in Garden City. Major improvements include new electrical service, and remodeled bath and kitchen. There is a 2 1/2 car garage too. Just close the deal and start collecting rent. \$69,900.

**EXCELLENT STARTER** on a beautiful double lot. 3 bedrooms, 2 1/2 baths, 2 car garage, finished basement and more. \$99,000.

**HARRY S.**

**WOLFE**  
474-5700

### 318 Redford

**BY OWNER, 3 bedroom Bungalow.**  
Gas heat, insulation, new floor, patio, 1 car garage, Bloomfield Hills Schools. Private beach & dock. 18655 Lennox. For Appt. 464-1048

**GREAT BUY & AREA**  
Redford area, 3 beds & 2 1/2 baths, 3 bedroom aluminum bungalow, new heat, water & electrical, all appliances, 2 car garage, \$109,000. By Owner. Call 324-0000. 474-9419 MASDA. After 5pm. 278-2884

**NICELY DECORATED**  
Starter Home with 2 bedrooms, formal dining room, carpeted, finished basement, 2 1/2 car garage. \$82,000. 538-9449

**REDFORD TWP. - 1972, very clean**  
4 bedroom ranch, country kitchen with appliances, full basement, \$89,900. Call 464-2046

**THREE Bedroom, 1 1/2 story brick**  
move in condition. New furnace & hot water heater, finished basement, 1st floor laundry, 2 car garage. \$81,500. D. Tyner Real Estate. 468-0608

**Ask for Jack**

**302 Birmingham Bloomfield**

**BEVERLY HILLS - Unique New Eng**  
style home in large estate. 3 bedrooms, Custom 2 bedrooms, 1 1/2 baths with large living room & fireplace. Many quality features at \$107,000. Call 464-2046

**BEVERLY HILLS SUB. Spacious**  
older home in desirable area. Designers-renovated interiors. Sunny 1 1/2 bath kitchen with bay window in open eating area, granite counter, eat & counter space. Living room with natural fireplace. A built-in bookcase, dining room with bay window to deck & patio. Beautifully landscaped fenced yard. 3 bedrooms with excellent closet space. Hardwood floors, 2 car garage, central air, central energy efficient furnace. \$129,900. Owner: 648-6761

**BIRMINGHAM by owner, Master**  
bedroom, 4 bedrooms, 2 1/2 baths, open concept living room, 2 car garage, finished basement, 1st floor laundry, 2 car garage, 1st floor laundry, 2 car garage. \$178,000. Birmingham 648-6099

**BIRMINGHAM BY OWNER**  
Wallace Frost designed Country French house style home located in Birmingham. 3 bedrooms, 2 1/2 baths, 2 car garage, finished basement, 1st floor laundry, 2 car garage, 1st floor laundry, 2 car garage. \$178,000. Birmingham 648-6099

**BIRMINGHAM - Downtown, Beautiful**  
3 bedroom, 2 1/2 baths, 2 car garage, finished basement, 1st floor laundry, 2 car garage, 1st floor laundry, 2 car garage. \$178,000. Birmingham 648-6099

**BIRMINGHAM - Beautiful**  
3 bedroom, 2 1/2 baths, 2 car garage, finished basement, 1st floor laundry, 2 car garage, 1st floor laundry, 2 car garage. \$178,000. Birmingham 648-6099

**BIRMINGHAM - Beautiful**  
3 bedroom, 2 1/2 baths, 2 car garage, finished basement, 1st floor laundry, 2 car garage, 1st floor laundry, 2 car garage. \$178,000. Birmingham 648-6099

### 303 West Bloomfield

**BY OWNER, 4 bedroom ranch, family**  
room, dining room, sunroom, 2 1/2 baths, 2 car garage, Bloomfield Hills schools. Private beach & dock. \$189,900. 691-5442

**COLONIAL - Four bedrooms, 3 1/2**  
baths, central air, Bloomfield Hills Schools. Buyers Only. \$199,000. By appointment weekends: 691-9211

**BLOOMFIELD ON THE PARK**  
BY OWNER  
Bloomfield Hills Schools. Move-in condition. \$240,000 in-ground pool, in-house hot tub, Guardian Alarm System. Newly finished kitchen, lower level and outside deck. Two full baths, 2 full bath with whirlpool. Many other luxuries too numerous to mention. \$279,000 or best offer.

**HOME OFFICE**  
628-0051  
691-8600  
Ask for Douglas

**CONTEMPORARY RANCH on outdoor**  
patio. Great room, dining room, family room, remodeled kitchen, breakfast area, 3 bedroom plus 4th bedroom/playroom, 2 full baths, 2 1/2 car garage. Private wooded lot with in-ground pool, air, mesh mesh. \$194,900. Appointment. 691-5120

**NEW 1,425 sq. ft. 1 1/2-level, 1 1/2**  
baths, 3 bedrooms, garage, wood windows, brick, Case Lath accent. \$79,900. John. 695-5120

**OPEN SUN, 1-5pm** or by Appt. Call 3 bedroom Starter home with built-in hot tub, 2 car garage. Call 355-3025, even-weekends, 595-6008

**THREE BEDROOM Colonial in**  
Westland Sub. West Bloomfield, private lot, 3 bedrooms, 2 1/2 baths, 2 car garage, finished basement, 1st floor laundry, 2 car garage, 1st floor laundry, 2 car garage. \$178,000. Call 648-6099

**WALNUT LAKE, CONTEMPORARY**  
3 bedroom, 2 1/2 baths, 2 car garage, finished basement, 1st floor laundry, 2 car garage, 1st floor laundry, 2 car garage. \$178,000. Call 648-6099

### 306 Southfield-Lathrup

**BIRMINGHAM SCHOOLS - 4 bedroom**  
colonial, family neighborhood with pool deck. \$99,900. Call: 944-9720 or 595-8008

**CRANFORD VILLAGE, 3 bedroom**  
1 1/2-level, 2 full baths, central air, new carpet, beamed ceiling, fireplace, open ground pool, deck, mature trees, very clean. Must be seen - only \$84,500.  
OWNER  
595-6644 or 595-2210

**IMMEDIATE**  
Mint 3 bedroom brick cape cod in beautiful Lathrup Village. Dining room, country kitchen, 2 bedrooms, 2 1/2 baths, 2 car attached garage. \$99,900. Ask for:

**JULIE**  
**CENTURY 21**  
Gold House Realtors  
478-4660 261-4700

**LATHRUP VILLAGE - 2 bedroom**  
brick English cottage with Spanish tile roof, remodeled kitchen, granite counter, remodeled bath, 2 car attached garage, 2nd floor laundry, 2 car garage, 1st floor laundry, 2 car garage. \$99,900. Call 648-6099

**SOUTHFIELD, Beautiful**  
apartment for rent. 2 bedrooms, 2 1/2 baths, central air, many extras. \$55-624

**SOUTHFIELD, 11th & Lathrup area, 3**  
bedroom colonial, newly decorated, 2 1/2 baths, central air, many extras. \$99,900. Call 648-6099

### 308 Rochester-Troy

**ROCHESTER HILLS - By Owner**  
New English Cape Cod near Oakland U. 7 1/2 car garage, 3 bedrooms, 2 1/2 baths, living room, dining room, 2nd floor laundry, 2 car garage, 1st floor laundry, 2 car garage. \$148,900. For appointment, call 464-1048

**CRANFORD VILLAGE, 3 bedroom**  
1 1/2-level, 2 full baths, central air, new carpet, beamed ceiling, fireplace, open ground pool, deck, mature trees, very clean. Must be seen - only \$84,500.  
OWNER  
595-6644 or 595-2210

**IMMEDIATE**  
Mint 3 bedroom brick cape cod in beautiful Lathrup Village. Dining room, country kitchen, 2 bedrooms, 2 1/2 baths, 2 car attached garage. \$99,900. Ask for:

**JULIE**  
**CENTURY 21**  
Gold House Realtors  
478-4660 261-4700

**LATHRUP VILLAGE - 2 bedroom**  
brick English cottage with Spanish tile roof, remodeled kitchen, granite counter, remodeled bath, 2 car attached garage, 2nd floor laundry, 2 car garage, 1st floor laundry, 2 car garage. \$99,900. Call 648-6099

**SOUTHFIELD, Beautiful**  
apartment for rent. 2 bedrooms, 2 1/2 baths, central air, many extras. \$55-624

**SOUTHFIELD, 11th & Lathrup area, 3**  
bedroom colonial, newly decorated, 2 1/2 baths, central air, many extras. \$99,900. Call 648-6099

### Country Atmosphere

is yours to savor in this large 3 bedroom custom built ranch home. This temporary styled home offers - formal dining room, sunny kitchen, family room, natural stone fireplace, solar room, full basement and 2 car attached garage - plus many other quality features. Excellent location of other fine homes. Asking \$135,000.

**CENTURY 21**  
Hartford South 464-8400

**COUNTRY KITCHEN, brick 3 bedroom,**  
2 1/2 baths, 2 car garage, 1st floor laundry, remodeled bath. New paint & carpet. \$82,500. By owner: 622-8887

**BOOKLE & MILE, 4 bedroom, 2 1/2**  
bath Colonial. Central air, fireplace, maintenance-free exterior, many extras. \$95,000. 464-4054

**ENGLISH TUDOR - extra premium**  
wooded lot with ravine. 2500 sq. ft., 4 bedrooms, 2 1/2 baths, 1st floor laundry room, central air conditioning, occupancy by contract. \$189,900.

**GREAT ROOM**  
Overlooks treed backyard. 3 car garage, 2 1/2 baths, aluminum trim, attached garage, central air, finished basement, 1 1/2 baths, 4th bedroom in basement. \$73,000.  
Call JULIE

**CENTURY 21**  
Gold House Realtors  
478-4660 261-4700

**Here's Another Dandy**  
Charming brick ranch, 3 bedrooms, 2 1/2 baths, large family room, carpet throughout, 1 1/2 car garage. At only \$91,900. Call:

**ALICE**  
**CENTURY 21**  
Gold House Realtors  
478-4660 261-4700

# CROSSWORD PUZZLER

- ACROSS**
- Greek letter
  - Running
  - Tattles
  - River banks
  - Hebrew month
  - Mitigate
  - Brother of Odin
  - The two of us
  - Vast ages
  - Loom device
  - Tumble
  - Promontory
  - Land measure
  - Texas city
  - Lampreys
  - Teutonic deity
  - Dillseed
  - Holds a session
  - College deg.
  - Variety of
- DOWN**
- chalcedony
  - Wooden shafts
  - Choose
  - Fate
  - Flat part of antler
  - Solo
  - Single item
  - Greek letter
  - Concerning
  - Middle East country
  - Roman gods
  - Pertaining to the teeth
  - Worn away
  - Accumulate
  - Selenium symbol
  - Room in harem
  - S-shaped molding
  - Synthetic material
  - Strict
  - Either
  - Hebrew festival
  - Arrow poison
  - Ms.
  - Fitzgerald
  - Babylonian deity
  - Equally 12 ins.
  - Part of camera
  - Pelticoat
  - Peruse
  - Halt
  - Ailment
  - Bridge term
  - Council
  - Frolics
  - Spanish title
  - Evaded
  - Samarium symbol
  - Agave plant
  - Underground excavations
  - Choir voice
  - Ripped
  - Audience
  - Not all
  - Mountain on Crete
  - Niton symbol
  - Fulfill

## Answer to Previous Puzzle

B R A W A D O L A M A  
R E T E V I A I D O L  
A L L W A S T E D I E  
T A W A S H D R S E  
T A I N T B E A S T  
A I S L E B I N P E S  
T O I L M A T R A N T  
E N D F A N M E S S Y  
E V E R S E A M  
L A E A S T A R L E  
O V A S T E E R A I T  
C O N S T E L L A T I O N  
O N T O A L E E D N A

© 1986 United Feature Syndicate

### 319 Homes For Sale Oakland County

**ALBURN HILLS** - Perfect Starter home on large country lot. Spacious kitchen & living room, newly remodeled, 2 bedrooms, gas furnace, basement. \$34,900. 344-0883

**BY OWNER** 26400 Lorenz, Madison Hts. Nice starter, 2 bedroom ranch, 2 1/2 car garage. 782-4202

**MILFORD** - Brick Cape Cod, 3 bedrooms, 2 baths, basement. Attached garage on 3 scenic acres. \$129,000. Even, 885-1773

**NEAT**, clean, well maintained, re-decorated, 3 bedroom, 1 bath, basement, 2 lots, oak floors, finished. Fennel. Call after 6 P.M. 542-9832

**Quick Occupancy**  
**CUSTOM QUALITY-BUILT HOMES**  
Models Open Daily thru Sun., 3-7pm  
Clarkston, a Done Fine Construction Office, 363-0385 Model, 625-5643

**WALLED LAKE** - By owner, charming 2 bedroom, hardwood floors, central air, lake privileges, all appliances. \$36,900. 624-1293

**WIXOM** - Desirable Hidden Creek Sub. 3 bedroom ranch, living room, family room, full basement, fenced yard/pool, 2 large decks, beautifully landscaped. \$78,900. For appointment, call 624-0851

### 320 Homes For Sale Wayne County

**COUNTRY LIVING**  
Remodeled 4 bedroom farm home, 2 barns, 3 car garage, on 6+ acres. Call State Owner must sell. 261-7707

**OPEN SUNDAY 1-4** - 4 bedroom home in secluded sub., family room w/ fireplace, formal dining room, 2 full baths, country kitchen w/ pantry, 2 car attached garage. \$61,500. 328-0052, 368-5644, or 729-1375

**THREE BEDROOM STARTER** in City of Wayne. Immaculate home features neutral decor, hardwood floors, and maintenance free exterior. Close to schools and community center. Good family neighborhood. Just reduced. \$35,000.  
CALL FRANCES BITTO

**Merrill Lynch Realty**  
626-9100

**WELL CARED FOR**  
Cozy home, featuring large country kitchen, 2 bedrooms, newer roof and furnace, in NorthWay Detroit, bordering Redford. \$23,900. Call 261-5080

**THOMPSON-BROWN**

### 324 Other Suburban Homes For Sale

**BELLEVILLE** - Spacious ranch style 3 bedrooms, 2 baths, \$82,000. Lakeside Realty. Pam: 699-1020 or 697-8419

### 325 Real Estate Services

**ARE YOU COLLECTING** on Land? We'll help you find the best deal. Call Perry Realty 478-7840

**LIST your home** with us or **BUY** a home thru us and receive a **FREE** Home Warranty valued at \$300. Call Century 21, Country Hills, 4088 Telegraph, at Long Lake, Bloomfield Hills. 540-3050

**326 Condos For Sale**  
**BLOOMFIELD TWP.**  
2 bedroom plus den, bi-level, approx. 2200 sq. ft., 15 Miles/Telegraph area. Cathedral ceiling in great room-18 ft. High brick fireplace, custom decorated, includes all appliances. Ideal for single individual or young couple. \$92,500. Call Steven Morley/day 540-1950 even. 855-8171

**BUILDER'S CONDO** - Downtown Birmingham: 547 Merrill, 2,000 sq. ft. plus finished basement. 2 car attached garage. Many extras! \$290,000. 688-1200 & 644-7853

**BY OWNER** Luxury condo in beautiful Colony Farms, situated on picturesque pond with willow trees. Featuring 2 bedrooms, 2 1/2 baths, full basement, large kitchen, marble sink in master bedroom & many more fine appointments. \$115,000. By appt only. 453-7376

**CANTON** - Charming 2 bedroom townhouse. Partially remodeled. Includes kitchen appliances, Sheldon & Warren. Must see! \$42,500 or \$7000 above mortgage. 453-1385

**CROSSWINDS NOVI**  
Ranch, 2 bedrooms, 2 full baths, skylight, studio ceilings, fireplace, private courtyard, garage. Immediate occupancy. 348-0877

**CROSSWINDS** of Farmington Hills. 2 bedroom townhouse, 1 1/2 baths, skylights, fireplace, air, private court yard, sheltered parking. Immediate occupancy. 348-0877

**CROSSWINDS** of Farmington Hills. 2 bedroom townhouse, 1 1/2 baths, basement, central air, immaculate, extras. \$89,900. Even. 681-2187

**FARMINGTON HILLS** - BY OWNER  
Open Sun 1-5pm  
12th Estates. Lovely 1 bedroom, carpet, all appliances. Beautiful grounds. \$49,900. Call 851-5598

**NORTHVILLE** - Highland Lakes. 3 bedroom, 2 1/2 bath on the Lakes. Newly decorated, must see to appreciate. \$89,900. 348-9854

**NORTHVILLE LEXINGTON CONDO**  
2 bedroom, walk out from lower level, overlooks stream, 2 full baths plus 2 half baths, attached garage, laundry on 1st floor, prime location. \$99,500. 348-2723 246-0298

**PLYMOUTH-2** bedroom, 2 1/2 bath, fireplace, finished lower level, garage, utility room, pool, 15 mile & Benjamin, Royal Oak. 549-2640

**SOUTHFIELD** - 2 bedrooms, 2 baths, beautifully decorated, 1,450 sq. ft., central air, all appliances, private patio, swimming pool, large storage area, available furnished or unfurnished. 352-0252

**BY OWNER** - 3rd floor, 3 bedroom, fireplace, elevator, underground garage, utility room, pool, 15 mile & Benjamin, Royal Oak. 549-2640

**327 Duplexes For Sale**  
**BIRMINGHAM** - Excellent condition. Garage, 2 large bedrooms, each fireplace, air conditioned, good schools. \$185,000. 644-0510

**328 Mobile Homes For Sale**  
A NEW 2 bedroom home in Southfield, \$1,660 down, only \$315 month including park rent. Little Valley, 478-4072

### 328 Condos For Sale

**OPEN SUN. 2-5PM**  
**FARMINGTON HILLS** - 2 bedrooms, air, adult community, 2848 & Mills, E. of Middlebelt, Bldg. 3, No. B-1. \$42,000.

**VAN ESLEY REAL ESTATE**  
Plymouth 455-0806

**PLYMOUTH CHARNWOOD CONDOS (PHASE II)**  
FROM...\$44,900

Great location...across from the Plymouth Hills. 1 and 2 bedrooms, carpets, patio/balcony, carpeting & appliances.  
\$120,000 RESERVES YOUR UNIT.  
CONTINENTAL REALTY 855-0101

**PLYMOUTH TWP. RANCH CONDOS**  
2 bedroom, 2 bath, 1st floor fireplace, basement, 2 car attached garage, breakfast room off private entry deck. Low \$90's. Reserve now for spring '87 occupancy.  
**MEADOW HILL DEVELOPMENT CORP.**  
459-6260

**ROCHESTER** 2 bedrooms, 2 1/2 baths, balcony, garage, walk-out basement. Immaculate. Walled/Adams area. \$91,900. 275-9541

**ROCHESTER** - 3 level, 2 bedrooms, 2 1/2 baths plus kitchen, large family room, like new condition, woodsy area. \$76,900. Even. 373-6798

**WEST BLOOMFIELD** - Luxury Center Townhouse. 2 bedroom, 2 1/2 baths, private entrance, 2 1/2 car garage, 2 decks. 691-4200

**WESTLAND** condo. 2 bedrooms, 1 1/2 baths, courtyard location, all drapes, kitchen appliances, garage, basement. Livonia Schools. \$124,500. 661-0424

**3 CONDO PROJECTS**  
Available in Novi or Farmington Hills. 55 units in Novi near 10 Mile & Haggerty. In Novi with Walled Lake frontage, priced right.  
Farmington Hills, luxury units, good terms. \$150,000. Call after 5pm.  
FOR DETAILS CONTACT  
Dennis Dickstein  
847-7100  
RALPH MANUEL ASSOCIATES

**327 Duplexes For Sale**  
**BIRMINGHAM** - Excellent condition. Garage, 2 large bedrooms, each fireplace, air conditioned, good schools. \$185,000. 644-0510

**332 Mobile Homes For Sale**  
A NEW 2 bedroom home in Southfield, \$1,660 down, only \$315 month including park rent. Little Valley, 478-4072

### 332 Mobile Homes For Sale

**CHAMPION 1983**, 34 x 62 double decker, 10 acres, rolling Pines Lake, garden with sky light, separate dining & laundry rooms, neutral interior. Now in a very nice park. Large lot with pond in back. Lots of privacy. \$200,000 firm. 624-9888

**CHOOSE REDFORD LOCATION**  
New 1 bedroom home. Walk to shopping. On bus line. Adults only. \$12,800.

**Wonderland MOBILE HOME SALES, INC.**  
4475 Michigan Ave at Belleville Rd.  
397-2330

**ELCONA 1988** Mobilhome, 3 bedrooms, remodeled bathroom, curtains & appliances stay. Gas to appliances. \$4000/best. 397-0813

**HAPPY HOUSE** 1982, 14x70, 2 large bedrooms, large full bath, very desirable park. Anderson windows throughout, beautiful lot & a half, won't last!  
465-0881

**Need Financing?**  
Call Foremost Home Financial for further information at 955-7080

**NEW DOUBLE WIDE**  
Set up on 3.5 acre adult lot in Belle Villa. No pets. 3 bedroom 2 bath. Off street parking. \$35,900. 20 year financing.  
**Wonderland MOBILE HOME SALES, INC.**  
4475 Michigan Ave at Belleville Rd.  
397-2330

**REDFORD** - 12 x 52 7/2 Monarch, 2 bedrooms, porch, skirting, shed, new kitchen, asking \$8,200. 535-3289 or 532-2847

**REDMAN 1988** 14x70 in Novi Meadows. 2 bedrooms, 2 baths, chapel ceiling. \$17,500. 348-8787

**333 Northern Property For Sale**  
**BOYNE COUNTRY** - 3 bedroom, 1 1/2 bath, ranch, 1 1/2 acres, trout stream, 1,000 feet off Lake Charlevoix, 10 minutes to Boyne Mountain. Must see! \$46,800. 854-8724

**HARBOR SPRINGS GREAT CORPORATE RETREAT**  
3 bedroom, 3 bath, professionally decorated luxury condo. Separate in-law apartment. On Round Lake, walking distance to Lake Michigan. Indoor pool/spa, tennis, 1/2 acre. Days: 618-582-2811 618-582-9636

**HARBOR SPRINGS**  
Outstanding residential/resort community. Wooded, meadow & always building sites available. Heminger Pedersen Real Estate, Inc. 194 E. Main St. Harbor Springs, MI 49740. Agent: Gloria Pitt, Office: 618-528-2178. Home: 618-528-8856

**HOUGHTON LAKE**, super location. Year around 3 bedroom furnished cottage with garage. By owner. \$29,900. After 5pm. 622-5004

**LAKE CHARLEVOIX** - Adjacent to city, 135 ft. building site, township water, septic approval, sandy beach. \$82,500. Evenings. 1-616-547-5124

**LAKES OF THE NORTH** - S. of Gaylord, 1 acre, includes riding, fishing, swimming, golf, skiing, private airstrip, etc. After 5pm 624-0029

**LEWISTON** Year round cottage on 5 acres, needs some interior finishing. \$27,000. Call 981-2402

### 333 Northern Property For Sale

**HUNT** - camp, invest & enjoy Lake Country, 10 acres, rolling Pines Lake, garden with sky light, separate dining & laundry rooms, neutral interior. Now in a very nice park. Large lot with pond in back. Lots of privacy. \$200,000 firm. 624-9888

**IDEAL GET-AWAY RETREAT**  
For the nature enthusiast, 49 beautiful acres with two new 1 bedroom cabin, completely furnished, near National Forest, in the U.P., near Newberry. Will be yours up to you if necessary. \$25,000. Land Contract. \$8000 down, 10 years, 10% interest. Payments \$184.28. Bidding due to B. Realty World Hutchison Realty. 517-673-7773

**LAKE CHARLEVOIX SUNSETS**  
Horton Bay - 30 acres, high on a hill with panoramic view of Lake Charlevoix. Professionally decorated, extensively landscaped, 3 bedrooms, 3 baths, 2 kitchens, 2 dining rooms, built in pool. \$249,000. Owner. Days: 618-582-2811 618-582-9636

**TRAVERSE CITY** - lake view lots, with access, half to 2 acre restricted, terms. \$4500 to \$9000. 455-2002

**WILDWOOD ON WALLOON**  
Near Charlevoix & Petoskey  
**CAREFREE CONDO** living at it's finest. 4 bedrooms, 3 full baths, loft, recreation room, spa, pool, in immaculate, like new, designer decorated throughout. Golf, tennis, skiing, & Walloon Lake activities. Available immediately. By Owner. Call: 618-582-9085

**336 Florida Property For Sale**  
**CONDO** - Clearwater Top-of-World, 2 bedrooms. Owner selling. #11 (613) 797-6463

**HUTCHINSON ISLAND** - 2 bedroom 2 bath, 3rd floor, S.E. corner, furnished, professionally landscaped. \$45-452

**333 Northern Property For Sale**  
**BOYNE COUNTRY** - 3 bedroom, 1 1/2 bath, ranch, 1 1/2 acres, trout stream, 1,000 feet off Lake Charlevoix, 10 minutes to Boyne Mountain. Must see! \$46,800. 854-8724

**339 Lots and Acreage For Sale**  
**ACREAGE**: 28 heavily wooded acres located in area of Executive Homes & Estates, Southern Lapeer County, 31st Jan. 1-313-678-2215 Quaker Realty

**BECK RD. & X-WAY**, Here, "13" 3/4 acre hot spot, water in front, septic done, excellent investment. 474-4643

**BINGHAM FARMS** - wooded 1 1/2 acres. Beautiful location, Birmingham school district. City water & sewer. Deeded road. 649-0274

**BLOOMFIELD HILLS**, Echo Park, garage corner lot, prime location. \$138,000. Call after 5pm. 644-5253

**CANTON** - Just Listed. 4.5 acres, high density multiple, on Haggerty Road. 8-16 units per acre.

**VAN ESLEY REAL ESTATE**  
Plymouth 455-0806

**CANTON** - One acre residential, Ridge Road, S. of Ford Rd. 205 ft. frontage. \$10,000. Call: 313-700-0000. \$13,000 Cash. 397-8550

**340 Lake-River-Resort Property For Sale**  
**BURT LAKE** - Contemporary year round home of Maple Bay, 100 ft. of lake frontage, 2,750 sq. ft., 5 bedrooms, 3 baths, modern kitchen, hardwood floors, 3 car garage, 100' Lake Michigan frontage. Great retirement or 2nd home. For information or appointment call: (616) 529-8619

**DIAMOND LAKE** cabin, White Cloud, MI, 1 bedroom, bath, furnished. Sandy beach, all sports. \$19,900. Owner: 616-649-2242

**LELAND**, MI modern home w/4 bedrooms, 2 baths, fully equipped kitchen, 2 car attached garage, 2 large decks, 100' Lake Michigan frontage. \$135,000. Call after 5pm. 644-5253

**PICTURESQUE SUMMER HOME**  
Located on Fawn Island in the St. Clair River opposite Marine City, MI. Complete seclusion within 1 hour of the Detroit area. House is unique and of quality construction. 3 fireplaces, beamed ceiling throughout, 120 ft. of steel walled boat dockage all spring piled. \$160,000 U.S. \$225,000 Canadian. If interested call for appt. 313-822-3589

### 339 Lots and Acreage For Sale

**CANTON** - 36 acres, close to every thing. Bargain price. Seller wants offer.

**VAN ESLEY REAL ESTATE**  
Plymouth 455-0806

**CLARKBTON**, 1 1/2 acres, wooded, lakeview, suitable for walk-out. In picturesque Deer Lake Farms. \$98,000.

**DAVISBURG**  
6 rolling acres, 333-836. Beautiful building site close to I-75. \$19,900. 885-1634

**FARMINGTON HILLS**, 9 & 1/2 Middlebelt area. 60x100 Residential Lot. \$9,300. Land Contract terms. 635-1489

**FOWLerville** - Country living. 3 acres \$10,000. 11 acres \$18,000. 82 acres \$37,000. Riverbank Estates. Call for brochure.

**VAN ESLEY REAL ESTATE**  
Plymouth 455-0806

**HIGHLAND TWP.**  
Clyde Rd. 5 acres. High rolling, pine trees. \$29,900. 385-1977

**LAST LOT** in Plymouth, 70 x 187, all improvements, over 200 trees, building permits pulled, \$17,000 on Land Contract. 437-8981

**TROY** - John R/Harvard/South Blvd. (20 Mile Rd.). Wooded residential lots 80' or 160' x 211'. Good schools, terms. Owner. 968-8057

**340 Lake-River-Resort Property For Sale**  
**BURT LAKE** - Contemporary year round home of Maple Bay, 100 ft. of lake frontage, 2,750 sq. ft., 5 bedrooms, 3 baths, modern kitchen, hardwood floors, 3 car garage, 100' Lake Michigan frontage. Great retirement or 2nd home. For information or appointment call: (616) 529-8619

**DIAMOND LAKE** cabin, White Cloud, MI, 1 bedroom, bath, furnished. Sandy beach, all sports. \$19,900. Owner: 616-649-2242

**LELAND**, MI modern home w/4 bedrooms, 2 baths, fully equipped kitchen, 2 car attached garage, 2 large decks, 100' Lake Michigan frontage. \$135,000. Call after 5pm. 644-5253

**PICTURESQUE SUMMER HOME**  
Located on Fawn Island in the St. Clair River opposite Marine City, MI. Complete seclusion within 1 hour of the Detroit area. House is unique and of quality construction. 3 fireplaces, beamed ceiling throughout, 120 ft. of steel walled boat dockage all spring piled. \$160,000 U.S. \$225,000 Canadian. If interested call for appt. 313-822-3589

## Country Ridge...

### The Natural Choice New Luxury Apartments

Settled on acres of woodlands, Country Ridge is the natural choice for carefree, resort-style living. This beautiful rental community features:

- Trees, trees, trees
- Private entrances
- European-crafted kitchen cabinets
- Washer and dryer hook-up
- Pool with spa
- Lighted tennis courts

And scenic paths, jogging trails and wooded hiking trails.

Country Ridge Apartments the natural choice for the discerning individual.  
From \$540.  
2-Bedroom, 2-Bath Units From \$655

## Country Ridge

Call (313) 661-2399

### 400 Apartments For Rent

**TIMBERIDGE**  
An Apartment Community of Uncompromised Quality in Farmington Hills

**LARGE 1 & 2 BEDROOM APARTMENTS**  
Featuring

- Individually controlled central air conditioning & heat
- Large private balcony or patio • Spacious closet & storage area in apartment • Double-bolt security system • Dishwasher & waste disposal • Self-cleaning oven • Range • Frost-free refrigerator/freezer • Sliding glass doorwall • Drapes • Plush carpeting • Large pantry • Convenient parking area • Energy-efficient insulation

**CLOSE-IN FARMINGTON LOCATION**  
East off Orchard Lake Road on Folsom Road (extension of 9 Mile Road), corner of Tuck Road.

**1 BEDROOM FROM \$475**  
**2 BEDROOM FROM \$545**

MGR-478-1487 OFFICE: 775-8200

One of the most exclusive addresses in Southfield

**SUTTON PLACE**

Spacious one floor living or townhouses, the choice is yours. Limited access service beautiful setting on ravines.

- HEAT INCLUDED • 1570-2600 sq. ft.
- Attached garages or covered parking
- Central Air • Appliances, plus self-cleaning oven • Your own elegant private club with card rooms and heated pool, kitchen, wet bar, Swedish sauna • Plus much more!
- Minutes from Town Center Lodge Expressway & Shopping

From \$660 Open Mon.-Sat. 9 a.m.-5 p.m. Sun. 12-5 p.m.  
Stop in to submit name for waiting list 358-4954

The most prestigious address in Southfield  
OPPOSITE PLUM HOLLOW GOLF CLUB  
NINE MILE ROAD BETWEEN LAMAR & TELEGRAPH

**THE RIGHT ADDRESS NOVI-FARMINGTON**

**PAVILION COURT APARTMENTS**

**HEALTH CLUB NEW 2 BDRM/2 BATH FROM \$605**  
\*INCLUDES 1st MONTH'S RENT FREE

- Private entrance
- Washer and dryer in unit
- All tile bathroom
- All wood kitchen cabinets
- Call for details
- Jogging trail with 32 fitness stations
- Swimming pool & tennis courts
- Spacious patio or balcony
- Carport (included in rent)
- Central air conditioning
- Immediate occupancy
- Furnished Basic Apts. available

Call 624-6464

### 400 Apartments For Rent

**LIVONIA Woodridge Apts.**

Now accepting reservations, 1 & 2 bedroom apts., \$475 & \$550 mo., eastside of Middlebelt between 6 and 7 Mile.

Open Mon. thru Fri. 8:30 to 5. Eves. by appt. Sat. 10 to 2 pm.

**477-6448**

**WHITEHALL APARTMENTS**

Luxurious 2 Bedroom Apartments

- 2 Full Baths • Carpets • Pool
- FREE CABLE TV • SECURITY

Adult Community - reserved for residents over the age of 50.

W. 9 MILE AT PROVIDENCE DR. IN SOUTHFIELD

Office Open Daily  
**557-5339**

**EXCLUSIVE LUXURY BIRMINGHAM APARTMENTS**

New and convenient in-town location, 280 Daines St.

Neutral decor, fireplace, 2 baths, window treatments, washer, dryer, and all appliances included. Available immediately. Two - 1600 sq. ft. 2 bedroom apts. \$1800 per mo. One - 1100 sq. ft. 1 bedroom apt. \$1200 per mo.

Contact: Dian Pastor.  
**UNIPROP 645-9220**

**Beautiful 1 & 2 Bedroom Apartments from \$345**  
Cable TV Now Available

- Heat included
- Carpeting
- Air Conditioning
- Balcony or Patio
- Swimming Pool
- Clubhouse
- Convenient to Twelve Oaks Mall

**THE VILLAGE IN WIXOM**

Call 624-6464

### 400 Apartments For Rent

**Imperial Manor APARTMENTS**

**1 BEDROOM SPACIOUS UNITS**

Includes heat, water, air conditioner, carpeting, laundry and storage facilities and pool

7 Mile - Telegraph Area

Call Mon.-Fri. 8:30-5 p.m. **538-2158**

**LINCOLN TOWERS**  
A quiet retreat Adult community

Studios 1 & 2 Bedrooms From \$70

FREE CABLE TV, SECURITY  
Heat, Central Air, Appliances, Carpeting, Community Room, TV & Card Room, Pool  
Lincoln Road at Greenfield **868-0011**

**BIRMINGHAM**

Prime location. Large 2 bedrooms, 1 1/2 baths, basement, carpeting, central air. \$650 to \$675.

**649-6909**  
Offered by Woodbury Management Inc.

**This Summer, Enjoy Living!**

From spacious one and two bedroom apartments with spectacular balcony views to a heated indoor swimming pool, Westland Towers offers you everything you need to enjoy living!

- Nine-story, high-rise luxury
- Sauna and Game Room
- Tennis courts
- Ideal location
- Rent includes heat

**721-2500**

**Westland Towers**  
Located on the scenic, rolling hills of Westland, Michigan. Call for details.

**Put yourself in this picture**

**... just minutes from home to work.**

You no longer need to sacrifice gracious living and the good life for business convenience. Now you can have both. Green Hill's gorgeous 75 acres of park and woodland, peace and tranquility, lie right next door to the I-275 corridor - Michigan's multi-billion dollar explosive



# CLASSIFIED REAL ESTATE

## 340 Lake-River-Resort Property For Sale

BURT LAKE - M-58 & I-75. 200 ft. water frontage on beautiful high banks. Unique custom design, 3 bedrooms, 3 baths, beamed ceilings, many amenities. 2 1/2 acres wooded. \$194,500. Call 644-3629 or 616-338-8490

## 342 Lakefront Property

BELLEVILLE LAKE, 1000 frontage, approx 2 acres, prestige residential area, priced for quick sale. \$80,000. 697-1567

ORCHARD LAKE, 1 plus acres, 60 ft. frontage, \$150,000. 681-1314

LAKE HURON - North Lakesport, 2 story, 3 or 4 bedrooms, 1 1/2 baths, 2 car garage & shop, 50x200 ft. lot, by owner, \$97,900 (313) 327-2074

## 342 Lakefront Property

BRIGHTON - small lake, 2 acres, \$35,000; 10 acres/65,000. REMIND YOU OF NORTHERN MICHIGAN, yet close to I-80 and Grand River. Springgrove Estates. Call for brochure.

## VAN ESLEY REAL ESTATE

Plymouth 455-0806

HOUGHTON LAKE - 2 bedroom cottage, 1 block from lake, \$19,800. \$4500. assumes FHA mortgage. Payment \$217. No qualifying. 457-8894

GENESSEE County - Near Flint, large home - overlooking private lake. Pool, a beautiful wooded setting, 10 acres or more. 313-783-7877

## 342 Lakefront Property

CONTEMPORARY LAKEFRONT Cedar Ranch with walk-out basement, located on 2.48 acres with 1977 of lake frontage. Features fireplace, glass doors, open floor plan. Too many amenities to list. N. Oakland City, \$225,000. Group One Realtors, Inc. ERA Mr. Jackson, 681-2700

## LITTLE BAY Dunes - U.P.

3 yr. old, year around home, 2-3 bedrooms, fireplace, partial basement, wood/gas heat, separate 18 x 24 guest cottage/workshop, dock & boat lift, sandy beach, large trees & garden area terraced to beach. 200 x 800 ft. lake frontage. \$25,000 or 100 ft. frontage for \$25,000. Call 1-800-474-6784

LAKE ORION Cottage, private dock, spectacular view east & west. Land contract available. \$75,000. 595-8750 or 603-8884

## 342 Lakefront Property

LOWER STRAITS LAKE 4 bedroom, 3 bath Custom, 2 fireplaces, acre, golf-front. \$278,000. 683-8309 or 353-7420

## ORCHARD LAKE Access & Dock

Custom home on 1.8 acres, beautiful pool & amenities. \$355,000. Call Owner 681-2708

THREE bedroom chalet on a private lake with 6 acres N. of Lapeer, 1 1/2 hrs. from Detroit. 793-8059. 873-7871

## 348 Cemetery Lots

CADILLAC MEMORIAL Gardens West, Family lot - 4 spaces. Garden of Christ. \$1,800. or best offer. 477-4882

## 348 Cemetery Lots

GREEN SEEN 2 grave lots, \$400 each. Garden of Assumption 648-6158

## WHITE CHAPEL CEMETERY

17 lots, \$500 each. 478-8880

## 351 Bus. & Professional Bldg. For Sale

FERRISDALE - Zoned Office, 2,000 sq. ft. building, 60 ft. frontage on S. M. E. of Woodward. By Owner. 666-8200

## 352 Commercial / Retail

CANTON - I-75/FORD RD., 10 acres, zoned highway commercial. Many uses including regional shopping, hotels, etc. Adjacent 10 acres also available. 477-4882

## VAN ESLEY REAL ESTATE

Plymouth 455-0806

COMMERCIAL BUILDING for Sale Prime Southfield location, over 1,800 sq. ft. Central air, alarm system. Immediate occupancy! Land Contract terms available. \$119,000. Call for details. 687-8010

2 COMMERCIAL BUILDINGS 3 ADJOINING LOTS Real Estate Auction June 28, 12-20PM Location: From I-96 exit at Evergreen, go North to Schoolcraft, turn left 1/4 mile to sale site.

Offering: Larger building 2,085 sq. ft. w/single lot. Smaller building joined w/2 lots. Properties will be offered in bulk subject to piecemeal bidding.

Terms: Deposit of \$5,000 on sale day by cash or certified check and balance at closing, or Land Contract with 20% down & balance in 3 years. Arrange financing and be prepared to buy.

Inspection: By appointment or morning 9-12. When AUCION SERVICE Plymouth: 313-458-5144 Detroit: 313-434-1670 Auctioneers note: Excellent location, close to freeways, completely fenced complex.

BUILDING - 1200 sq. ft. on a 7 1/2 x 125 ft. lot. Partially finished, large side yard, heated garage, 24x24 ft. W. McNichols (3 blks. W. of Telegraph), 535-2246 or 691-7056

CANTON - Canton Center/Ford Road, 10 acres, zoned office, adjacent to I-75. Many uses including medical, dental, bank, funeral home, assembly hall, much more. Two other office locations available. 477-4882

## VAN ESLEY REAL ESTATE

Plymouth 455-0806

354 Income Property For Sale WAYNE - 8 unit. Grosses \$25,140. Tenants pay heat & light. Fully occupied. Waiting list. New roof. Terms available. 664-9255

## 358 Mortgages & Land Contracts

A BARGAIN Cash for Existing Land Contracts Second Mortgages @ Highest \$\$\$ Perry Realty 478-7540

BANK STREET MORTGAGE Accepting Applications Refinanced, home loans, rate lock. Onyx Plaza, Southfield. 350-3180

HIGHEST YIELD Five year suburban mortgages. Quality plus. 781-7939

## 360 Business Opportunities

ACRES 2 1/2, fenced approximately 6,000 sq. ft., plus 400 sq. ft. office, large overhead doors, many many commercial use possibilities. High traffic Oakland Ave location, \$189,900, terms, flexible sale. Call for details. 352-1828

APPROXIMATELY 1800 sq. ft. home, zoned office. Situated ideal location, Waterford Twp near Cass Lake. Land Contract terms, or lease option, flexible seller. \$95,500. 322-1828

BUILD residual income business in conjunction with full time occupation. Proprietary legal service, other. Large potential. Sets. 655-1513

CERAMIC business for sale or will consider partnership. Call 721-1850.

FIRM with American & foreign patents - field proven product - is it comes to well established firm. Must have manufacturing, sales & promotional capabilities, non automotive product. Write to P.O. Box 4, Livonia MI 48152.

EXCELLENT business opportunity. This is an opportunity to get into the temporary business by purchasing a well established temporary agency serving the greater Detroit area. A catastrophic illness is forcing the owner to retire at this time. We are (T.E.S.) Temporary Employment Services. The business was established in November 1981. T.E.S. has been a steadily managed company & has shown steady growth & profit. The gross sales for 1988 calendar year was over 1 1/2 million dollars. The company is well equipped & has over 100-150 employees. Any responsible offer will be considered, additional information will provide upon request. For further information write P.O. Box 0083, Southfield, Mich 48078-0083 or call Mrs. F.F. 686-8966, ask for Marie or Larry. 313-888-1707

## 360 Business Opportunities

PROMINENT ESTABLISHED Health Club. Very high profit. Good terms. Livonia/Farmington area. Finance available. 575-0009

RETAIL GIFT BUSINESS. Turn key - Sacrifice Price due to health. Excellent chance to acquire going business at an attractive price. Call Steve Russell, Broker. 313-248-4481

SUPER Walled Lake area office building, ideal for banking, credit union, medical office, etc. Lease or buy. \$150,000. \$150,000. Will remodel to suit, flexible seller. 352-1828

EXPANDING SERVICE Business for sale, earnings up to \$100,000, will trade established, accounts for 6 months or less. 455-4225

FOR SALE: Established ice cream parlor. All equipment included. Priced to sell. Western Oakland County location. 477-4882

GAB & GO. DEALERSHIP AVAILABLE THE IDEAL LOCATION Grand River & Oriskany, Farmington

2-bay Service Station - Good Gasoline Volume - Excellent location - \$125,000 - For application, contact: Roy T. Harroty, 395-3000 An Equal Opportunity Employer

RN - Historical Registry. Excellent potential for Bed & Breakfast - 12 rooms, dining area, two lounges, kitchen facilities, 2 house-keeping cottages, 284 ft. x 288 ft. lot plus 105 ft. on Lake Huron. Call Cecile Lewis at Don Jordan Real Estate before 5pm. (313) 738-9161. After 5pm, 738-9173

LAUNDRYMAT - Bowling Green, Kentucky. Excellent location, near college. Seeks for \$39,500. Must sell. Call for more information: Call Mike Ziegler Thera, 510 P.M. 352-8800.

LOUNGE, BY OWNER N.W. Oakland City, 3,400 sq. ft. Ample parking, 6 Day Operation. \$160,000, with 840,000 down. Will consider other Real Estate in trade. Call after 10am, 477-8246

MLM PROFESSIONALS Exploding! Ground floor opportunity in network marketing. Just expanding to Detroit area. No inventory, no paperwork. No competition. Pays 7 levels. Detroit winner, last sale \$100,000. Call Mike Ziegler Thera, 510 P.M. 352-8800.

Open Placements - HOME SITE NETWORK - Residential - Business - Commercial Local Training Local Accounts Travel Bonuses Business Experience Preferred Equal Opportunity

For Appointment 522-8899

PARTNERSHIP AVAILABLE No money up-front. Wanted a young, pleasant, hard working dynamic person to build up an Old Park Koster butcher shop. This will lead to partnership with much growth potential for the right person. Send resume to: Box 640, Old Park Koster, Livonia, Michigan 48150

## 362 Real Estate Wanted

ABILITY TO HELP. Need to sell a residential or multi-family property? Will look at any property, any condition. 682-5244

ABSOLUTELY CASH In 8 hours for your home. Any condition Call Ron 458-3400

BRICK, 3 bedroom, full basement, large lot. Prefer Northway, Farmington Hills or W. Bloomfield, and Contract or assume balance. Best ask for Mary Alice, 477-5460 Res. 484-2804

CASH TODAY OR GUARANTEED SALE Also if in Repair or Need Of Repair

Castelli 525-7900

FULL PRICE - Will pay full price for your property if you are willing to sell on flexible terms, (bills or no money down). Call Martin, 682-1165

LIVONIA HOUSE needed immediately by widow & 2 children. Cash or assumption. Owners preferred. Call after 8pm: 1-317-823-8898

WANTED - 1900 sq. ft. or more office building, Middlebelt or west, 5 miles or N. of 5 Mile. Call and leave message. 342-4100

## 400 Apartments For Rent

IMMEDIATE OCCUPANCY APARTMENTS BY CONSOLIDATED INVESTMENTS 3 locations to serve you GARDEN CITY, WESTLAND, PLYMOUTH Spacious 1 & 2 bedroom & studios Management by owner Excellent location Carpeting, Appliances Laundry facilities, Cable TV, Includes utilities, etc. Open Mon. thru Fri. 9 am-5 pm Sat. 9 am-1 pm Sun. by appointment only 425-0930

## 400 Apts. For Rent

Bayberry Place Apts. HEAT INCLUDED One and 2 Bedroom Apartments from \$554. Includes: Dishwasher, Porcelain, Air Conditioning, Swimming Pool, Clubhouse, etc. Close to Shopping, 1 block North of Maple, 1 block E. of Coolidge, near Somerset Mall, Troy. Open Weekdays 9-5 643-9109

Abandon Your Hunt - All Areas PAY NO FEE UNTIL YOU SEE 100% OF

Qualified Rentals In Our First Calling For TENANTS & LANDLORDS ONLY 100% YEAR SHARE LISTINGS 642-1820 884 S. Adams, Birmingham, Mich.

"ABSOLUTELY EVERYTHING" 2 Bedroom, 1 1/2 baths, kitchen fully remodeled. Don't miss! 567-5650 Rent/Finders Small fee

ADULTS PARADISE 2 bedrooms, 2 baths, complete facilities, privacy, modern decor. 557-5800 Rent/Finders Small fee

APARTMENTS We carry a large selection of 1-2-3 bedrooms, all prices and areas. Fully computerized for quick results. Let us make appointments for you. 500 Fee. Money Back Guarantee.

RENTAL GUIDE 546-5240 \$10 Off With This Ad

A SPACIOUS 3 BEDROOM Only \$400. Complete kitchen, kids' pool, carpeting, 1.5 baths. 557-5800 Rent/Finders Small fee

AUBURN HILLS 2088 PATRICK HENRY DR. Large 3 room-1 bedroom apt. in small well maintained complex. From \$400. Including heat. See list or call 578-8770

BELLEVILLE - In-lotfront 1 bedroom apartment with fireplace, kitchen in location, stock available. \$398 month including heat. Available July 1. Leave message 642-8738

BERKLEY - 1 bedroom and office area, monthly \$420, per month plus security. No children, no pets, cable, 12 mile and Coolidge Area, don't miss! Call 546-5240

BILLS PAID, 1 bedroom, laundry, dining room, apt. or 2 bedroom duplex, fenced yard just \$225. No Pets. Rental Guide, 248-2240

BIRMINGHAM, charming one bedroom, newly decorated, immediate occupancy. \$475-\$500, close to downtown Birmingham. 642-8774

BIRMINGHAM, just right for a couple. Need as a 2nd bedroom within walking distance to town. Garage, Basement, \$225. Broker, Nancy & Benson, Inc. Call 644-7000

BIRMINGHAM PROPER - Two-bedroom apartment. Large 3 bedroom, 1 1/2 bath, full basement. Walk to town. \$395. per month. No pets. Call Glenn Heagy, 642-8770

BIRMINGHAM/2nd-1st. 1 1/2-bath, with view, 2 bedrooms, 2 baths, \$1,180/mo. 646-7008

BOTSFORD PLACE GRAND RIVER - 8 MILE Behind Botford Hospital SALE!!! 1 Bedroom for \$400 2 Bedroom for \$50 3 Bedroom for \$719 PETS PERMITTED Smoke Detectors installed

Call for more information, phone 477-8484 27883 Independence Farmington Hills

## 400 Apartments For Rent

IMMEDIATE OCCUPANCY APARTMENTS BY CONSOLIDATED INVESTMENTS 3 locations to serve you GARDEN CITY, WESTLAND, PLYMOUTH Spacious 1 & 2 bedroom & studios Management by owner Excellent location Carpeting, Appliances Laundry facilities, Cable TV, Includes utilities, etc. Open Mon. thru Fri. 9 am-5 pm Sat. 9 am-1 pm Sun. by appointment only 425-0930

## 400 Apts. For Rent

BIRMINGHAM - 2nd & 3rd. 2 bedrooms, 2 baths, full basement, \$425. Call for details. 642-8770

BIRMINGHAM - 2nd & 3rd. 2 bedrooms, 2 baths, full basement, \$425. Call for details. 642-8770

BIRMINGHAM - 2nd & 3rd. 2 bedrooms, 2 baths, full basement, \$425. Call for details. 642-8770

BIRMINGHAM - 2nd & 3rd. 2 bedrooms, 2 baths, full basement, \$425. Call for details. 642-8770

BIRMINGHAM - 2nd & 3rd. 2 bedrooms, 2 baths, full basement, \$425. Call for details. 642-8770

BIRMINGHAM - 2nd & 3rd. 2 bedrooms, 2 baths, full basement, \$425. Call for details. 642-8770

BIRMINGHAM - 2nd & 3rd. 2 bedrooms, 2 baths, full basement, \$425. Call for details. 642-8770

BIRMINGHAM - 2nd & 3rd. 2 bedrooms, 2 baths, full basement, \$425. Call for details. 642-8770

BIRMINGHAM - 2nd & 3rd. 2 bedrooms, 2 baths, full basement, \$425. Call for details. 642-8770

BIRMINGHAM - 2nd & 3rd. 2 bedrooms, 2 baths, full basement, \$425. Call for details. 642-8770

BIRMINGHAM - 2nd & 3rd. 2 bedrooms, 2 baths, full basement, \$425. Call for details. 642-8770

BIRMINGHAM - 2nd & 3rd. 2 bedrooms, 2 baths, full basement, \$425. Call for details. 642-8770

BIRMINGHAM - 2nd & 3rd. 2 bedrooms, 2 baths, full basement, \$425. Call for details. 642-8770

BIRMINGHAM - 2nd & 3rd. 2 bedrooms, 2 baths, full basement, \$425. Call for details. 642-8770

BIRMINGHAM - 2nd & 3rd. 2 bedrooms, 2 baths, full basement, \$425. Call for details. 642-8770

BIRMINGHAM - 2nd & 3rd. 2 bedrooms, 2 baths, full basement, \$425. Call for details. 642-8770

BIRMINGHAM - 2nd & 3rd. 2 bedrooms, 2 baths, full basement, \$425. Call for details. 642-8770

BIRMINGHAM - 2nd & 3rd. 2 bedrooms, 2 baths, full basement, \$425. Call for details. 642-8770

BIRMINGHAM - 2nd & 3rd. 2 bedrooms, 2 baths, full basement, \$425. Call for details. 642-8770

BIRMINGHAM - 2nd & 3rd. 2 bedrooms, 2 baths, full basement, \$425. Call for details. 642-8770

BIRMINGHAM - 2nd & 3rd. 2 bedrooms, 2 baths, full basement, \$425. Call for details. 642-8770

BIRMINGHAM - 2nd & 3rd. 2 bedrooms, 2 baths, full basement, \$425. Call for details. 642-8770

BIRMINGHAM - 2nd & 3rd. 2 bedrooms, 2 baths, full basement, \$425. Call for details. 642-8770

BIRMINGHAM - 2nd & 3rd. 2 bedrooms, 2 baths, full basement, \$425. Call for details. 642-8770

BIRMINGHAM - 2nd & 3rd. 2 bedrooms, 2 baths, full basement, \$425. Call for details. 642-8770

BIRMINGHAM - 2nd & 3rd. 2 bedrooms, 2 baths, full basement, \$425. Call for details. 642-8770

BIRMINGHAM - 2nd & 3rd. 2 bedrooms, 2 baths, full basement, \$425. Call for details. 642-8770

BIRMINGHAM - 2nd & 3rd. 2 bedrooms, 2 baths, full basement, \$425. Call for details. 642-8770

BIRMINGHAM - 2nd & 3rd. 2 bedrooms, 2 baths, full basement, \$425. Call for details. 642-8770

BIRMINGHAM - 2nd & 3rd. 2 bedrooms, 2 baths, full basement, \$425. Call for details. 642-8770

BIRMINGHAM - 2nd & 3rd. 2 bedrooms, 2 baths, full basement, \$425. Call for details. 642-8770

BIRMINGHAM - 2nd & 3rd. 2 bedrooms, 2 baths, full basement, \$425. Call for details. 642-8770

BIRMINGHAM - 2nd & 3rd. 2 bedrooms, 2 baths, full basement, \$425. Call for details. 642-8770

BIRMINGHAM - 2nd & 3rd. 2 bedrooms, 2 baths, full basement, \$425. Call for details. 642-8770

BIRMINGHAM - 2nd & 3rd. 2 bedrooms, 2 baths, full basement, \$425. Call for details. 642-8770

BIRMINGHAM - 2nd & 3rd. 2 bedrooms, 2 baths, full basement, \$425. Call for details. 642-8770

BIRMINGHAM - 2nd & 3rd. 2 bedrooms, 2 baths, full basement, \$425. Call for details. 642-8770

BIRMINGHAM - 2nd & 3rd. 2 bedrooms, 2 baths, full basement, \$425. Call for details. 642-8770

BIRMINGHAM - 2nd & 3rd. 2 bedrooms, 2 baths, full basement, \$425. Call for details. 642-8770

BIRMINGHAM - 2nd & 3rd. 2 bedrooms, 2 baths, full basement, \$425. Call for details. 642-8770

BIRMINGHAM - 2nd & 3rd. 2 bedrooms, 2 baths, full basement, \$425. Call for details. 642-8770

BIRMINGHAM - 2nd & 3rd. 2 bedrooms, 2 baths, full basement, \$425. Call for details. 642-8770

# EVERYONE

# HAS

# SPRING FEVER.

## time-for-a-change

With springtime merchandise on your shelves, Mr. Businessman, lots of people out there are in the market to buy.



Use Classified! Advertising your merchandise in our columns will bring you extra business. You'll greet springtime in good spirits.

# Observer & Eccentric

## CLASSIFIED ADVERTISING

644-1070 Oakland County 591-0900 Wayne County 852-3222 Rochester/Rochester Hills

One Bedroom from \$528 Two Bedroom from \$579 For the term of the lease.

### Join the Club!

Highline Club is an exclusive, luxury apartment community with everything you want. Clubhouse, swimming pool, lighted tennis courts.

- Private entrances
- Cathedral ceilings
- Walk-in closets
- Washer/Dryer available
- Venice Blinds
- Garage
- Microwave

IMMEDIATE OCCUPANCY

### HIGHLINE CLUB APARTMENTS

Located on 9 Mile Road, West of Haggerty in New New Model Homes! 7 Days A Week 10-6 PM. 342-3400</

400 Apts. For Rent

IN CANTON TWP FRANKLIN PALMER On Palmer Rd., W. of Lilley 1&2 BEDROOMS from \$375 Includes Heat - Central Air Sound Conditioned - Carpeting Pool & Sauna - Cable TV Available Open Daily 9am-5pm 397-0200

Independence Green IMMEDIATE OCCUPANCY

Located in Farmington Hills. We offer luxurious apartment living that includes heat, water, washer and dryer, built-in vacuum system, no additional cost. Air conditioning, clubhouse with sauna, indoor and outdoor pool, tennis courts, golf course and much more is available. CALL/STOP BY TODAY 477-0133 471-6800 Grand River & Halsted Rds. Presented by Mid-America Management Inc.

KIDS OKAY - 2 & 3 bedrooms, air conditioned, dishwasher, move soon, \$420 & \$555. Many others. Fee, Rental Guide. 548-5240

LIVONIA - Woodridge, Six Miles/Middlebelt. One bedroom, adults, no pets. June rent paid. \$475 per month plus security. 323-0538 After 6:30pm. 334-4287

LIVONIA. One bedroom basement apt. GM plant area, \$50 per week. utilities included, partially furnished. 425-5233

NEWLY DECORATED 1 bedroom, heat, carpet, drapes, appliances, air, security system. From \$305. Schoolcraft/Outer Drive area. 531-8100

NINE MILE - HOOPER AREA. Spacious 2 bedroom townhouse, \$405 monthly. Decorated, central air, basements. No pets. 758-7050 MacArthur Manor

NOVI LOCATION. 2 bedroom townhouse, \$595, including 1 1/2 baths, carpeting and patio. 349-8200

OLD REDFORD area - 1 bedroom apartment, Lasher & Grand River. Air. 275 538-7013

ORCHARD LAKE ROAD. In Pontiac. Beautiful wood paneling featuring 1 & 2 bedroom apts. Includes heat, carpeting, air conditioner, cable TV, available. From \$335.

ORCHARD WOODS APTS. 334-1873

PERFECT FOR SINGLES! 2300. A/C. accepted. Complete kitchen. 557-5600 RentFinders Small fee

PERFECT 1 bedroom, dishwasher, air conditioned, balcony, \$325. We have 100's of units all areas. Fee, Rental Guide. 548-5240

PIERSON/WARREN near Telegraph. Deluxe 1 bedroom, plush carpeting, appliances, air, beautiful view. 4 story modern building with elevator. Great for seniors and couples - from \$325. Must see. 443-6889

PLYMOUTH DOWNTOWN - 1 bedroom, newly decorated, available July 15. \$450 security, \$450 per month. Heat & water included. 459-7221. 522-8978

Plymouth Hills Apts. 788 S. MILL

Modern 1 & 2 Bedroom Air Conditioned Fully Carpeted Dishwasher & Disposal Washer-Dryer in Each Apt Cable TV No Pets Easy Access to I-75 From \$445/\$495 Daily 12-6pm except Wed. & Sun. 455-4721

PLYMOUTH HILLCLIFF CLUB 12382 Risman Plymouth & Haggerty 1&2 BEDROOMS from \$395 Cable TV Available 453-7144

POUGHATSE PARK APARTMENTS 2420 Garrison Lane - 1 & 2 bedroom apts from \$395 includes heat, pool & patio, 2 bedroom townhomes with basement, \$400. Eur. 249-8555

Town & Country Apts. Spacious one & two bedrooms, fully carpeted, wood, air, heat included, adult preferred. No pets, from \$375. 46200 Pontiac Trail, near Beck Rd. 624-3194

400 Apts. For Rent

PLYMOUTH HOUSE APTS City of Plymouth Beautiful 1 & 2 bedroom apts. From \$410 & up Sr. Citizens welcome - no pets 453-6050

PLYMOUTH MANOR APTS City of Plymouth Central Downtown Area Beautiful 1 & 2 bedroom apts. From \$415 Sr. Citizens welcome - no pets 455-3880

PLYMOUTH - Nice studio, 3rd floor, skylight, beige carpet, appliances, nice quiet area. \$375 plus utilities 455-7287 or 981-1708

ROCHESTER - OAK HILL Apts. & townhouses starting at \$405, utilities furnished, security deposit required. 851-9751

ROOM FOR RENT Daily maid service, color TV, 24 hr. message service, \$550, for 1 person. Contact Creon Smith, Mayflower Hotel, Plymouth, MI 453-1200

ROYAL OAK, deluxe newly remodeled 2 bedroom, plush carpet, custom drapes, stone refrigerator, dishwasher, micro, swimming pool, heat & water \$595 548-0214

ROYAL OAK - sharp 1 bedroom, newly decorated, new carpeting, appliances, kitchen cabinets, \$450 monthly, adjacent William Beaumont Hospital. References. 548-9214

SEVEN MILE & Telegraph area. Low price, air conditioned, pool, \$345 to \$365. Call 9am-5pm. 334-4287

SOUTHFIELD/BIRMINGHAM - location. Luxury apartment community has 1 & 2 bedroom apartments available. Microwave ovens, cathedral ceilings, 24 hour maintenance. Choice of custom floor plans & color schemes. Starting from \$580. Call 544-0059

SOUTHFIELD. One bedroom, near 12 Mile. Newly decorated, low level, with carpet, available July 1. \$495 month. 569-6597

TELEGRAPH 7 Mile area - 1 bedroom, air, 1st month rent & security, available July 10. Call 4-6 pm. 937-1172

THREE OAKS Troys newest luxury apartment community...

1 bedroom with den 2 bedrooms All appliances Intercom system Clubhouse Swimming & tennis Rural setting CONVENIENTLY LOCATED 1/2 Mi E of Crooks on Wattles at I-75 OPEN: Mon. thru Fri., 10-6 Sat., 10 - 4pm PHONE: 362-4088

TOWN APARTMENTS TROY On Kirts Blvd.

Modern 1 and 2 bedroom apartments. One bedroom, \$475, 2 bedroom, \$525. Heat and hot water included. Carpeting, air, dishwasher, large storage area. Quiet building. Half mile to I-75. July occupancy. Call 362-0711.

VENNY PINES APTS. Formerly Venny Pines Apts. SEE OUR NEW LOOK! New Landscaping/Carpeting thru Out 1 & 2 Bedroom From \$395 & up SR. CITIZENS WELCOME 261-7394

WESTLAND 6200 North Wayne Rd. 2 BEDROOM \$405 HEAT & HOT WATER INCLUDED Carpeting, appliances, swimming pool, 2 car parking. Adult section. Close to Westland Shopping Center 728-4801

WESTLAND Jcy & Newburgh area. Nice 2 bedroom, 1 1/2 baths, \$450 per month, heat included. Available July 1st. Ask for 455-4505

WESTLAND AREA Spacious 1 bedroom apartments \$410 monthly. Carpeted, decorated, pool & in a lovely area. Westland Woods Apts 728-2880

400 Apts. For Rent

VILLAGE GREEN SOUTHFIELD'S newest luxury apartment community ready for summer occupancy. Spacious 1 & 2 bedroom apartments featuring Clubhouse and full facilities including glass enclosed Jacuzzi, cathedral ceilings, fireplace, microwave, and more. Rentals from \$575. 12 Mile - Just E of Northwestern Hwy. Please call 356-8570

WESTLAND AREA EXTRAORDINARY Spacious 1 & 2 Bedroom Apts. Carpet, Patio, Air, Pool, Heat included. From \$415 Sr. Citizens welcome - no pets 455-3880

BLUE GREEN APARTS. Cherry Hill near Merriman. For Details 729-2242

Westland Area Spacious 3 bedroom apartment, \$370. Attractive 2 bedroom apartments, \$410. Carpeted, decorated & in a lovely area. Heat included.

Country Court Apartments 721-0500

WESTLAND - 6843 Wayne, near Hudson's 1 bedroom from \$395. Includes air conditioning, heat, carpet & swimming pool. No pets. Mature adults call 721-5466

BRING THE KIDS & PETS Nice 2 bedroom, garage, basement. Flexible lease. \$400/mo. Call 557-5600 RentFinders Small fee

CANTON - 3 bedroom brick, 1 1/2 baths, family room, fireplace, \$750 month plus \$750 security deposit. Mr. Birdsal, drive. 474-5150

CARPETED BEAUTY, 3 BEDROOM Large kitchen, modern decor, air. Fenced yard for kids! Call Today! 557-5600 RentFinders Small fee

CHILDREN & PETS FINES! Nice 2 bedroom, easy access! Garage for your car! \$375/mo. 557-5600 RentFinders Small fee

COMFORTABLE 3 Bedrooms, \$500. Fenced yard for kids! Basement, washer/dryer, central air. Small fee. 557-5600 RentFinders Small fee

"CUTE & COZY" 2 BEDROOMS East-in Kitchen, washer & dryer. Families Welcome! Only \$445. 557-5600 RentFinders Small fee

CUTE W/ Bloomfield 2 bedroom, lake privileges, basement, year lease. \$575 month. Call after 6pm 628-6074

DEARBORN AREA - 3 bedroom, plus fine. \$350 or newer home, garage, air conditioned. \$550. Others. Fee, Rental Guide. 548-5240

DETROIT - Brightwood, Schoolcraft & Outer Dr., 2 bedrooms, sundeck. Immediate occupancy. \$300/mo. \$325 security. Call after 6, 425-1816

EVERGREEN - SOUTHFIELD AREA. 3 bedroom, \$295 per month plus security. Call after 7pm 553-4203

FARMINGTON HILLS, 3 bedroom, 3 bath, carpeted, family room, 2 car garage. \$1200 per month, security deposit. References. 737-0313

FARMINGTON HILLS - New home for rent, never been lived in, 3 bedroom, 2 1/2 bath colonial. \$1200 per month. 356-1319

FARMINGTON HILLS, 4 or 5 Bedroom Fully equipped kitchen, newly decorated. Kids-pets allowed. 557-5600 RentFinders Small fee

GARDEN CITY - FOR RENT 3 bedroom home, \$425, month. Call: 1-629-1842

FRANKLIN VILLAGE. Charming 4 bedroom home in the HEART OF FRANKLIN VILLAGE features 1 1/2 baths, living room with fireplace, dining room, and 2 car garage. All on a large lot! \$1000 per month.

HANNETT, INC. REALTORS 646-6200 Abandon Your Hunt - All Areas

PAY NO FEE UNTIL YOU SEE 100% OF Qualified Rentals IN OUR FREE CATALOG FOR TENANTS & LANDLORDS Our 10th Year! SHARE LISTINGS. 642-1820 884 S. Adams, Birmingham, Mich.

A BETTER 3 bedroom, fenced, brick, central air, fully computerized. Referral service. Fee, Rental Guide. 548-5240

FEHNDALD OR Warren, 2 and 3 bedrooms, fenced yard or 2 car garage. \$425 and \$450. Others. Fee, Rental Guide. 548-5240

SHORT TERM LEASES Adult and family units, 8 prime suburban locations. Utilities included. Complete with housewares, linens, color TV & pool. Weekly maid service available. Just like home! EXECUTIVE LIVING SUITES 474-9770

404 Houses For Rent

ABSOLUTELY BEAUTIFUL! Better 3 bedroom, Outer area, Nice Yard, Garage, Call Today! 557-5600 RentFinders Small fee

"A FIREPLACE & MORE!" Sharp 4 bedroom, east-in kitchen! Carpet, garage, Families Welcome! 557-5600 RentFinders Small fee

AIR CONDITIONED 3 bedroom, fenced, patio, garage, \$550. Many other services guaranteed. Fee, Rental Guide. 548-5240

BEGIN HERE - Kids, pets okay, 3 bedrooms, garage, just \$350. Open 7 Days. Many other homes daily. Fee, Rental Guide. 548-5240

BETTER 3 BEDROOM - Only \$450. Equipped kitchen, private yard. Perfect for kids & pets. Garage! 557-5600 RentFinders Small fee

BIRMINGHAM - Beverly Hills; 3 bedroom, 1 1/2 bath, 1825 Brwood 2 blocks S. of 14 Mile, E. of Pierce, \$700 mo. plus security. 656-2927

BIRMINGHAM - Ideal location, double 2 bedrooms with dining room, basement, kitchen, appliances, washer, dryer, \$625, mo. 396-0635

BIRMINGHAM - 2 bedroom home, hardwood floors, appliances, garage, nice neighborhood, no pets. \$600 per mo. After 5pm. 540-2725

BLOOMFIELD TWP. - 3 bedroom, 2 bath ranch on large lot. Family room with fireplace, central air, carpeting, with opener. Birmingham Schools & mailing, lake privileges. Available July 1st at \$1100. WEST BLOOMFIELD - 4 bedroom, 2 1/2 bath colonial. Family room with fireplace, kitchen appliances, central air, attached car garage. \$1100 a month.

BRING THE KIDS & PETS Nice 2 bedroom, garage, basement. Flexible lease. \$400/mo. Call 557-5600 RentFinders Small fee

CANTON - 3 bedroom brick, 1 1/2 baths, family room, fireplace, \$750 month plus \$750 security deposit. Mr. Birdsal, drive. 474-5150

CARPETED BEAUTY, 3 BEDROOM Large kitchen, modern decor, air. Fenced yard for kids! Call Today! 557-5600 RentFinders Small fee

CHILDREN & PETS FINES! Nice 2 bedroom, easy access! Garage for your car! \$375/mo. 557-5600 RentFinders Small fee

COMFORTABLE 3 Bedrooms, \$500. Fenced yard for kids! Basement, washer/dryer, central air. Small fee. 557-5600 RentFinders Small fee

"CUTE & COZY" 2 BEDROOMS East-in Kitchen, washer & dryer. Families Welcome! Only \$445. 557-5600 RentFinders Small fee

CUTE W/ Bloomfield 2 bedroom, lake privileges, basement, year lease. \$575 month. Call after 6pm 628-6074

DEARBORN AREA - 3 bedroom, plus fine. \$350 or newer home, garage, air conditioned. \$550. Others. Fee, Rental Guide. 548-5240

DETROIT - Brightwood, Schoolcraft & Outer Dr., 2 bedrooms, sundeck. Immediate occupancy. \$300/mo. \$325 security. Call after 6, 425-1816

EVERGREEN - SOUTHFIELD AREA. 3 bedroom, \$295 per month plus security. Call after 7pm 553-4203

FARMINGTON HILLS, 3 bedroom, 3 bath, carpeted, family room, 2 car garage. \$1200 per month, security deposit. References. 737-0313

FARMINGTON HILLS - New home for rent, never been lived in, 3 bedroom, 2 1/2 bath colonial. \$1200 per month. 356-1319

FARMINGTON HILLS, 4 or 5 Bedroom Fully equipped kitchen, newly decorated. Kids-pets allowed. 557-5600 RentFinders Small fee

GARDEN CITY - FOR RENT 3 bedroom home, \$425, month. Call: 1-629-1842

FRANKLIN VILLAGE. Charming 4 bedroom home in the HEART OF FRANKLIN VILLAGE features 1 1/2 baths, living room with fireplace, dining room, and 2 car garage. All on a large lot! \$1000 per month.

HANNETT, INC. REALTORS 646-6200 Abandon Your Hunt - All Areas

PAY NO FEE UNTIL YOU SEE 100% OF Qualified Rentals IN OUR FREE CATALOG FOR TENANTS & LANDLORDS Our 10th Year! SHARE LISTINGS. 642-1820 884 S. Adams, Birmingham, Mich.

A BETTER 3 bedroom, fenced, brick, central air, fully computerized. Referral service. Fee, Rental Guide. 548-5240

FEHNDALD OR Warren, 2 and 3 bedrooms, fenced yard or 2 car garage. \$425 and \$450. Others. Fee, Rental Guide. 548-5240

SHORT TERM LEASES Adult and family units, 8 prime suburban locations. Utilities included. Complete with housewares, linens, color TV & pool. Weekly maid service available. Just like home! EXECUTIVE LIVING SUITES 474-9770

404 Houses For Rent

"HANDYMAN'S SPECIAL" 2 Bedrooms, Rent to Own! Kids-Pets Allowed. Garage. Only \$395. Call: 557-5600 RentFinders Small fee

HOUSES - FLATS We carry a large selection of 2-3 bedrooms, all prices and areas. Fully computerized for quick results. Let us make your appointment for you \$60 Fee. Money back guarantee.

RENTAL GUIDE 546-5240 \$10 OFF WITH THIS AD

LAHSER/5 Mile area, 3 bedroom, fenced yard, garage, basement. \$345/mo. + security deposit. Call 6pm-9pm. 265-8082

LANDLORDS We have many qualified tenants with references looking for homes in the following areas:

TROY ROYAL OAK DEARBORN LIVONIA SOUTHWEST WARREN OAK PARK ROSEVILLE DOWNRIVER PLYMOUTH FARMINGTON INKSTER BIRMINGHAM OTHERS TOO Priced from \$350-\$1,500 range. No charge for our referrals

RENTAL GUIDE 546-5240

LIVONIA - OPTION-TO-BUY 2 bedroom, 2 car garage & 1 1/2 bath. \$400/mo. - or for Sale by Owner for \$29,000. 474-3695

LIVONIA, Brick Ranch, 1,100 sq. ft., 3 bedrooms, 1 1/2 baths, living room, finished basement, 2 car garage. \$650/mo. 444-4253

LIVONIA, Downtown, 3 bedroom Bungalow, carpeting, drapes, 1 acre lot. \$1,000. \$1,000 occupancy. Immediate occupancy. Single's OK. 349-6334

LIVONIA, 3 bedroom brick, fireplace, garage, basement. \$650 month plus \$650 security deposit. Mr. Birdsal, days 474-5150

LOVELY 3 bedrooms, 1st floor laundry, 1/2 bath, lake area. Lake privileges. References, year lease. \$575/month. Perfect for family. \$650/mo. \$650 security. Call 557-5600 RentFinders Small fee

NICE LIVONIA AREA 4 BEDROOM. Complete kitchen, garage. Kids-Pets allowed. Under \$800/mo. 557-5600 RentFinders Small fee

OAK PARK - 10 Mile/Coolidge area. 2 bedroom, ultra clean, includes appliances, full bath, finished basement, 1 car garage. Call before 5pm. 479-8364

PERFECT 2 bedroom, fenced for kids, pets & appliances. \$450. Open daily. 9-11 a.m. Call. Fee, Rental Guide. 548-5240

PLYMOUTH. Setup to accommodate a handicapped person. 2 bedrooms, carpeted, Call between 9am and 5pm, ask for Connie. 453-3983

PLYMOUTH - 829 Forest, 3-4 bedrooms, 1 1/2 baths, in-town location & parking. Perfect for family. \$650 mo. Lease. Show Tues.-Wed. 453-0513

PRICED RIGHT - Cute 2 Bedroom Families Welcome! Basement, washer/dryer, central air. Small fee. 557-5600 RentFinders Small fee

RANCH - Bloomfield Hills. Many extras. \$800. We have many homes in most areas. Sizes & prices. Fee, Rental Guide. 548-5240

RENTAL OPPORTUNITY. Novi, Large 3 bedroom farmhouse. Big barn, shed, 2 car garage, acreage. Only \$850 plus \$850 security. 284-8500 Nov Rd. at 12 1/2. John. 624-8500

RENTERS Use our computerized list of houses, flats & apartments to find the place you are looking for.

FREE \$35 WITH AD Associated - Suite 210 22750 Woodward 544-0091

SOUTHFIELD - Country in the City. Year old brick, 2 bedrooms, fully furnished, \$600 unfurnished, plus security, 6 month lease. 355-4733

TAYLOR - Colonial, 4 bedrooms, 1 1/2 baths, finished basement, fenced yard, brick, central air, fully furnished throughout, stove & refrigerator included. \$675/mo. 1 month security. Call after 6pm 464-0082

THREE bedroom houses now available, nice areas, many with deluxe features. \$310 per month. 478-1124

TRIPLE AREA all modern cottages on body bottom lake, \$310 per month, playground, boats, no pets. 437-2810

CHARLEVOIX COUNTY - modern kitchen, 751-4765 873-3641

CHARLEVOIX - Deluxe condo, view of Lake Michigan. 2 bedrooms, 2 baths, in town. Available 7-19 to 8-6. \$700. week. 464-5392

CHEBOYGAN - Modern lakefront condo on Muncie Rd. 662-3139

CONTEMPORARY RETREAT on beautiful Lake Michigan. Near Charlevoix. July weeks available. Keep trying. 618-596-2715

CRYSTAL LAKE - Secluded luxury home. 2 bedrooms, 2 baths, in town. Available 7-19 to 8-6. \$700. week. 464-5392

412 Townhouses - Condos For Rent

BLOOMFIELD HILLS - 3 bedrooms, 1 1/2 baths, family room, air conditioning, pool, tennis courts. Call 557-5600 RentFinders Small fee

BLOOMFIELD - Luxurious 3 bedroom, 2 1/2 bath, \$500 per mo. overlooking Oakland Hills Golf Course. Call: 642-1820 or 445-9470

FARMINGTON HILLS - 12 Mile & Orchard Lake Rd area, Farmington Sq. Condos, 2 bedrooms, 2 baths, 1st floor. Immediate occupancy. Call: 642-1820 or 445-9470

ROCHESTER HILLS - Luxury 3 bedroom condo, 2 1/2 baths, 2 fireplaces, 3 car attached garage. Call: 645-0518 or 688-9000

ROCHESTER - Oakbrook West on Paint Creek 3 bedrooms, 1 double bath plus one half bath. \$1200 month includes heat & pool. Call: 645-0518 or 688-9000

ROCHESTER - Heat & pool, 2 bedrooms, 2 baths, sleep 6. 2 1/2 weeks available. N. Cook 427-9355

SAUL ON YOUR OWN private yacht, 1/2 acre, 3000 sq. ft. based on \$100,000. Call: 628-1097

SANFORD LAKE - Kitchennette Motel, 2 1/2 hours away. Sleeps 4, safe for children. Weekends weekly. 491-3000

TORCH LAKE cottages, 2 bedrooms & 4 bedrooms. Available June thru Sept. Days: Even. 489-0070

414 Florida Rentals Abandon Your Hunt - All Areas

ANN ARBOR TRAIL and Merriman area. Will rent finished basement to you. Landscaping, pool, etc. possible. Rent per month 1/4 utilities, security deposit required. Call after 6pm 425-8

BEDROOM in Troy, for adult/Student. Making, drinking, includes utilities, laundry room, privileges. First & last month rent, deposit. References required. Call Cheryl. 678-7338

BLOOMFIELD HILLS furnished room/bath, lovely home, non-drinking, smoking. \$325 mo. + deposit includes utilities & linens. 647-8823

CHARLEVOIX COUNTY - modern kitchen, 751-4765 873-3641

CHARLEVOIX - Deluxe condo, view of Lake Michigan. 2 bedrooms, 2 baths, in town. Available 7-19 to 8-6. \$700. week. 464-5392

CHEBOYGAN - Modern lakefront condo on Muncie Rd. 662-3139

CONTEMPORARY RETREAT on beautiful Lake Michigan. Near Charlevoix. July weeks available. Keep trying. 618-596-2715

CRYSTAL LAKE - Secluded luxury home. 2 bedrooms, 2 baths, in town. Available 7-19 to 8-6. \$700. week. 464-5392

ELIZABETH LAKE near Keego Harbor. Small cabins, \$140 per week. Swimming & sandy beach. 681-9899 or 878-1356

GAYLORD RESORT - New clubhouse with pool, steps & 6000 sq. ft. pool, tennis & ball field. \$300 per week. 464-3254

GRAND TRAVERSE BAY. Sharp, well furnished 5 bedroom on sandy beach, secluded area, sundeck & pool. Available June & July. 1-994-5627

HALE, luxurious family vacation lodge on beautiful spring fed Loon Lake. Incredibly spacious, private. Perfect for college student or family. Sleeps 10 easily. All new appliances, washer & dryer. 626-7411

HARBOR SPRINGS Lovely 4 bedroom, 2 1/2 bath condo with swimming pool & tennis courts. No pets. Call 557-5600

HARBOR SPRINGS - luxury condo in Harbor Cove, sleeps 6. By owner. Anytime. Lease message. 596-1006

HARBOR SPRINGS CONDO located in town near golf course. 2 bedrooms, 2 1/2 baths, air, sleeps 6.

DUPLEX in town on Main St., 2 bedrooms, 2 1/2 baths, full kitchen, 2 car garage. Available June & July. \$450 month. Large living room, dining room & kitchen. 455-9419

PLYMOUTH - downtown. Charming 1 person studio. Beamed ceiling, appliances, fireplace, washer, dryer, all utilities. \$425. 548-8248

500 Help Wanted

ASSISTANT MANAGER IF YOU ARE WILD & CRAZY AND NOT REAL LAZY

Then we're looking for 8 to 12 of you to fill various manager & rep positions. Must enjoy food & hot work and work well with people and the experience needed. Earn \$7.50 an hour with training. Call Mr. Looney 281-8228

ABOVE AVERAGE? Big phone Co. needs inside sales reps to handle incoming calls. Day or Even. Full Time. \$5. Hr.-\$6.50 90 days. Some recent sales a must. No Fees. Employment Opps. 540-7235

ACCOUNTANT A challenging position has become available with CPA firm in Bloomfield area. 5 yrs. CPA firm experience required. Jerome S. Chapman, CPA, PC. 855-9610

ACCOUNTANT Expanding Firm Can CPA firm seeking ambitious Staff Level Accountant. 1 year public accounting experience. Enthusiastic, team player. Resume to: Dunn & Roth, 800 Fern Can. St. 1400, Detroit, MI 48243

ACCOUNTANT For local CPA office. 3-5 years public accounting experience. Computer knowledge helpful but not necessary. Charness & Stone, CPAs. 567-3533

ACCOUNTANT Immediate opening for an experienced Accountant to assume full charge of company's accounting functions. Duties will include handling books of original entry thru G/L, preparation of monthly financial statements and preparation of all payroll and sales tax returns. Challenging position for person possessing good judgment, self motivation, and the drive to succeed. Will work as part of a team and effective communication skills required. Generous salary and benefit package. For consideration, send confidential resume, and salary expectation, to: P.O. Box 963, Southfield, MI, 48071

FOLLMER, RUDEWICZ & CO. Recruiting for An Equal Opportunity Employer

ACCOUNTANT Southfield CPA firm has position for individual with 2 to 5 years experience. Must have strong tax background. Salary plus benefits. Send resume to: M & G, 18911 W. 10 Mile, Suite 201, Southfield, Mich 48078

ADMISSIONS SALES Full time for local vocational school. Salary, plus commission and benefits. 2 years experience required. Call 506-2247.

Adult Librarian PART TIME City of Southfield Salary range \$9.23 to \$12.48 per hour and a comprehensive benefit package. Must have a Master's Degree in Library Science to provide general readers guidance and information on library facilities to adults. Apply: Personnel Department, City of Southfield, 28000 Evergreen Rd., Southfield, MI 48074, by 5 pm., Friday, July 11, 1986. An Equal Opportunity Employer

GREEN PLANT MAINTENANCE CO. needs people to maintain plants in commercial buildings & restaurants. Full-time, experience in landscaping & clerical. Advancement opportunities for aggressive people. Summer jobs for college students. \$1100-\$1300 per month to start. Must be over 16 and have a driver's license. Call 537-7068

AIRE-MASTER INDUSTRIES Hiring for all positions; stock & display, management training, marketing & clerical. Advancement opportunities for aggressive people. Summer jobs for college students. \$1100-\$1300 per month to start. Must be over 16 and have a driver's license. Call 537-7068

A Kelly job puts your skills to work today. If you're looking for a job you can start right away, look to Kelly Services. Because right now we're hiring light industrial workers - both men and women - for a variety of short and long term assignments.

Light Industrial Workers At Kelly, we'll help you arrange a work schedule around your busy college, family or personal schedule.

Plus, we can offer competitive pay, merit increases, vacation pay, bonuses - and the chance to work with some of the best companies in town.

For details call Kelly Services: 981-3130 Canton 522-4020 Livonia 522-3922 Livonia 729-1040 Westland

KELLY SERVICES The "Kelly Girl" People Not an employment agency - never a fee Equal Opportunity Employer M/F/H

A PERFECT OPPORTUNITY For responsible, enthusiastic persons with clear vision, sales or professional telephone experience helpful. Flexible hours, bonus incentive & medical benefits. Full or part time. For interview interview call Southfield 657-4759

APPLICATIONS are now being taken for position of Sales Rep. Starting rate of pay is \$9.00 per hour, 80 hours per week. Good working conditions. Applications may be turned up at the Warren Community Center, 4800 Howe Rd., Warren, 48090

Librarian/Teacher needed for 1st grade. Salary \$11,000. Call 537-7068

500 Help Wanted

ALWAYS JOBS AVAILABLE

We offer a variety of light industrial jobs. Various job locations to choose from.

On The Job Training All Shifts Available Full & Part Time Positions Never A Fee

IMMEDIATE JOB OPENINGS

Certified mechanics Machine Tool Wiremen Machine Operators

ACT FAST APPLY NOW

Join the force that keeps you working.

525-9191 LIVONIA 547-9300 ROYAL OAK

FUTURE FORCE TEMPORARY SERVICES

AN ENTRY LEVEL Sales Assistant for small Detroit manufacturer. Must be self motivated, willing to learn all aspects of our trade. Requires good verbal communication skills and ability to perform over-the-counter sales. 311-4225

APARTMENT MAINTENANCE for Southfield complex. Cleaning, grounds work and general maintenance. 554-3930

APT. MAINTENANCE Person needed to assist in apt. preparation, experience helpful but not necessary. Full time position, promotion possibility. 557-0610 Southfield area.

RENTAL AGENT to work part time in new Southfield apt. complex 358-0400

GALLERY ASSISTANT - Seeking personable individual with knowledge of art history for gallery in Southfield area. Call: 358-5421

ARTICULATE personable individuals to conduct telephone surveys. Day and evening shifts available. Training provided. No sales. Rochester/Big Beaver Rds., location. Call today: 528-3333.

ART/MUSIC TEACHER Experienced teacher for 1/2 day/Full day for pre-school & kindergarten children at Kensington Academy. For appointment, phone 548-1761

ASPHALT WORKERS - experienced only/only men, live man & laborers must be experienced. Starting pay \$6-87 hr. Ask for Randy, 7pm-9pm, 663-3406

ASSISTANT FOREMAN Full time in Plymouth for liquid packaging line. Excellent mechanical skills a must. Excellent pay based on experience. Send work history & references to Celis Corp., 445 Amelle St., Plymouth, MI 48170

500 Help Wanted

EXECUTIVE ASSISTANT TO TOP MANAGEMENT

We are an established service industry corporation. We offer an excellent career opportunity to a qualified individual with proven ability to assist our president & CEO. The successful candidate will have interaction with top level management staff & will perform diversified tasks to assist management. Strong organizational administrative & interpersonal skills are a must. Unlimited potential, excellent salary & company paid benefits make this a worth while opportunity.

Send your resume & salary requirements in confidence to:

P.O. BOX 5067 WARREN, MI 48090-5067 Att: Executive Assistant An Equal Opportunity Employer

New Novel location!

A Kelly job fits your lifestyle

At Kelly, we'll help you arrange a work schedule around your busy college, family or personal schedule.

Plus, we can offer competitive pay, merit increases, vacation pay, work close to home, bonuses - and the chance to work with some of the best companies in town.

Data Entry Secretaries Typists Receptionists Word Processors Switchboard Operators Light Industrial

So come to America's number one name in temporary help. We'll put you to work today - with no delay! Call for an appointment or more information.

553-7857 26950 Taft Road Novi

KELLY SERVICES The "Kelly Girl" People Not an employment agency - never a fee Equal Opportunity Employer M/F/H

For responsible, enthusiastic persons with clear vision, sales or professional telephone experience helpful. Flexible hours, bonus incentive & medical benefits. Full or part time. For interview interview call Southfield 657-4759

APPLICATIONS are now being taken for position of Sales Rep. Starting rate of pay is \$9.00 per hour, 80 hours per week. Good working conditions. Applications may be turned up at the Warren Community Center, 4800 Howe Rd., Warren, 48090

Librarian/Teacher needed for 1st grade. Salary \$11,000. Call 537-7068

500 Help Wanted

ASSISTANT INVENTORY MANAGER

Major medical supply distributor has an opening for an assistant inventory manager. This position requires high math aptitude, excellent phone skills, some college training preferred. A strong inventory control background is desired and experience in the medical industry a plus. Responsibilities include: Maintaining high service levels to customers by use of computer inventory system. Will work closely with customer service and warehouse personnel. Send resume to: White & White, Inc. Attention: Sue Piatlak 45755 Five Mile Plymouth, MI 48170

ASST MANAGER needed to start immediately. No experience necessary. Meet with good character. Expanding management program in effect. Call: 663-2333

ATTENTION DRIVERS! Local Carriage Company looking for experienced tractor/trailer drivers. Full time/benefits. Call: 464-0890

ATTENTION EARLY 84-86 HOUR Leading home cleaning company has daytime openings. No weekend Car necessary, mileage paid. Livonia 625-7200

ATTENTION HAIRDRESSERS Tired of working long hours for little pay? Come join our family at Fantasy Hair. Guaranteed wage & benefits. 546-7297

ATTENTION STUDENTS Hiring immediately. Part Plaza Concessions office needs 50 new employees for the summer months. Work every Fri., Sat. & Sun. through Labor Day including Motor City Jazz Festival & Michigan State Fair. Must be 18 or older. Self-motivated, sharp & aggressive a must. No experience necessary. If interested inquire at the Part Plaza Concessions office, Tues. June 24th & Wed. June 25th, 12:00pm-4pm only.

AUTO DEALER Trade School or some experience necessary. Apply in person: Page Toyota Body Shop Telegraph, K. O. Mile.

AUTO DEALER needs Service Writer Car Washers Must have Driver's License Apply in person: Action Oils, 33560 Plymouth Rd., Livonia

AUTOMATIC BROWN Machine Operators & Set Up Leaders wanted with experience on Brown & Sharpe & New Britain screw machines. We are a fast growing Livonia company with excellent benefits package including profit sharing & 401-K plan. Respond to: Box 894, Observer & Eccentric Newspapers, 36251 Schoolcraft Rd., Livonia, Michigan 48150

AUTO MECHANICS Exclusive BMW dealership has several openings for certified auto mechanics. Top pay - excellent benefits & a great team to work with plus an exceptional training program. Erhard BMW, 24130 Telegraph, Southfield, MI, 48074

AUTOMOBILE UNDERWRITER For the leading writer of auto insurance for educational employees, minimum 3 yrs. Persons Lines (auto/homeowners) experience, company or agency, College background or practical work experience. Salary commensurate w/qualifications. Benefits & work environment excellent. Resume to: P.O. Box 522, Birmingham, Mich., 48012

AUTOMOTIVE COUNTER SALES - automotive paint & body shop supplies, experience desired. Apply: Painters Supply, 6625 Middlebelt, Garden City.

AUTOMOTIVE PARTS Rebuilding company is hiring persons for training at a high level rebuilding mechanics. Some experience in automotive mechanics or machine shop benefits but not necessary. Apply 8AM-3PM at General Drivetrain Co., 15848 Glendale, Detroit, MI.

500 Help Wanted

COMMERCIAL LOAN OFFICER

Rapidly growing Oakland County bank seeks a Commercial Loan Officer with formal credit department background and a minimum of 1 year lending experience. Salary commensurate with experience. Send resume and salary history in confidence to:

PERSONNEL DIRECTOR, O.E. P.O. Box 5823 Troy, Mich. 48007-5823 Equal Opportunity Employer M/F

EMPLOYMENT SUPERVISOR

A local non-union, high technology manufacturing firm has an opening for an Employment Supervisor. We're seeking a highly motivated individual capable of assuming a personnel manager position within 1-2 years. The qualified individual will be degreed and have experience in safety, interviewing, policy administration and affirmative action. Exposure to an employee involvement process highly desirable.

Our company offers a competitive salary and an outstanding benefit package. Qualified candidates should mail their resume including salary history to:

NAS NATIONWIDE ADVERTISING SERVICE INC. NAS CONFIDENTIAL REPLY SERVICE Department 6-6-801 PR 1056 Penobscot Bldg., Detroit, MI 48226 Our client is An Equal Opportunity Employer

A Kelly job puts your skills to work today. If you're looking for a job you can start right away, look to Kelly Services. Because right now we're hiring light industrial workers - both men and women - for a variety of short and long term assignments.

Light Industrial Workers At Kelly, we'll help you arrange a work schedule around your busy college, family or personal schedule.

Plus, we can offer competitive pay, merit increases, vacation pay, bonuses - and the chance to work with some of the best companies in town.

For details call Kelly Services: 981-3130 Canton 522-4020 Livonia 522-3922 Livonia 729-1040 Westland

KELLY SERVICES The "Kelly Girl" People Not an employment agency - never a fee Equal Opportunity Employer M/F/H

A PERFECT OPPORTUNITY For responsible, enthusiastic persons with clear vision, sales or professional telephone experience helpful. Flexible hours, bonus incentive & medical benefits. Full or part time. For interview interview call Southfield 657-4759

APPLICATIONS are now being taken for position of Sales Rep. Starting rate of pay is \$9.00 per hour, 80 hours per week. Good working conditions. Applications may be turned up at the Warren Community Center, 4800 Howe Rd., Warren, 48090

Librarian/Teacher needed for 1st grade. Salary \$11,000. Call 537-7068

ASSISTANT MANAGER IF YOU ARE WILD & CRAZY AND NOT REAL LAZY

Then we're looking for 8 to 12 of you to fill various manager & rep positions. Must enjoy food & hot work and work well with people and the experience needed. Earn \$7.50 an hour with training. Call Mr. Looney 281-8228

ABOVE AVERAGE? Big phone Co. needs inside sales reps to handle incoming calls. Day or Even. Full Time. \$5. Hr.-\$6.50 90 days. Some recent sales a must. No Fees. Employment Opps. 540-7235

ACCOUNTANT A challenging position has become available with CPA firm in Bloomfield area. 5 yrs. CPA firm experience required. Jerome S. Chapman, CPA, PC. 855-9610

ACCOUNTANT Expanding Firm Can CPA firm seeking ambitious Staff Level Accountant. 1 year public accounting experience. Enthusiastic, team player. Resume to: Dunn & Roth, 800 Fern Can. St. 1400, Detroit, MI 48243

500 Help Wanted

AUTO MECHANIC

The #1 Tire & Auto Service retailer is expanding & is in search of qualified automotive technicians. "You" Mechanics \$13/hr Benefits include vacations, health & hospitalization & technical training to help further your career. Interested in the job? Call the #1 Auto Service Team! Call Bob: 353-0480

MARCH TIRE CO. (An Independent dealer of the Goodyear Tire & Rubber Co.)

AUTO MECHANIC Radiator hospital needs good qualified air conditioning & cooling system mechanics - Or trainees. Good pay & benefits for the right person. Call main office 85-0388

AUTO PARTS Counter Man/Outside Sales. Experience preferred. Commission paid. Call Mark Stern 11am Mon. thru Fri: 357-1900

AUTO PARTS Large metro area GM dealer is in immediate need of an aggressive, highly motivated Parts Counter Person with GM mechanical experience. This is a full time position with opportunity to advance. Please apply in person: Ken Rose, Parts Manager, Joe Parlan Chevrolet, 28111 Telegraph Rd., Southfield.

AUTO SHOP needs college student with car for assisting manager and cleaning. Full-time, summer job. Berkeley area. 546-9998

AUTO TECHNICIAN Fast growing GM dealer in Plymouth needs C-3 Performance Technician. Excellent pay & benefits. Apply to Tony Stipcak, Bob Jeanette Pontiac, 14848 Sheldon Rd., Plymouth.

AUTO WARRANTY CLAIMS CLERK GM dealership in Plymouth needs experienced warranty claims clerk. Excellent pay & benefits. Please call Jim Miller for appointment, Bob Jeanette Pontiac. 453-2500

AVAILABLE IMMEDIATELY GENERAL LABOR TRUCK DRIVERS HI-LO DRIVERS WELDERS PACKAGING ALL AREAS ALL SHIFTS MEN & WOMEN Apply Tues. - Thurs. 9-11 am & 1-3 pm. 2171 W. 10 Mile (10 Mile & Lahser) Personnel Pool NEVER A FEE

BAKERS - Donuts & bake goods. Full and part-time positions available. Experience preferred but will train. Good wages, steady employment. The Donut Depot, 561-7168

BAKER'S HELPER wanted for coffee & donut shop. Looney Baker of Livonia, Inc., 15631 Farmington Rd., 425-8606

500 Help Wanted

COMMERCIAL LOAN OFFICER

Rapidly growing Oakland County bank seeks a Commercial Loan Officer with formal credit department background and a minimum of 1 year lending experience. Salary commensurate with experience. Send resume and salary history in confidence to:

PERSONNEL DIRECTOR, O.E. P.O. Box 5823 Troy, Mich. 48007-5823 Equal Opportunity Employer M/F

EMPLOYMENT SUPERVISOR

A local non-union, high technology manufacturing firm has an opening for an Employment Supervisor. We're seeking a highly motivated individual capable of assuming a personnel manager position within 1-2 years. The qualified individual will be degreed and have experience in safety, interviewing, policy administration and affirmative action. Exposure to an employee involvement process highly desirable.

Our company offers a competitive salary and an outstanding benefit package. Qualified candidates should mail their resume including salary history to:

NAS NATIONWIDE ADVERTISING SERVICE INC. NAS CONFIDENTIAL REPLY SERVICE Department 6-6-801 PR 1056 Penobscot Bldg., Detroit, MI 48226 Our client is An Equal Opportunity Employer

A Kelly job puts your skills to work today. If you're looking for a job you can start right away, look to Kelly Services. Because right now we're hiring light industrial workers - both men and women - for a variety of short and long term assignments.

Light Industrial Workers At Kelly, we'll help you arrange a work schedule around your busy college, family or personal schedule.

Plus, we can offer competitive pay, merit increases, vacation pay, bonuses - and the chance to work with some of the best companies in town.

For details call Kelly Services: 981-3130 Canton 522-4020 Livonia 522-3922 Livonia 729-1040 Westland

KELLY SERVICES The "Kelly Girl" People Not an employment agency - never a fee Equal Opportunity Employer M/F/H

A PERFECT OPPORTUNITY For responsible, enthusiastic persons with clear vision, sales or professional telephone experience helpful. Flexible hours, bonus incentive & medical benefits. Full or part time. For interview interview call Southfield 657-4759

APPLICATIONS are now being taken for position of Sales Rep. Starting rate of pay is \$9.00 per hour, 80 hours per week. Good working conditions. Applications may be turned up at the Warren Community Center, 4800 Howe Rd., Warren, 48090

Librarian/Teacher needed for 1st grade. Salary \$11,000. Call 537-7068

ASSISTANT MANAGER IF YOU ARE WILD & CRAZY AND NOT REAL LAZY

Then we're looking for 8 to 12 of you to fill various manager & rep positions. Must enjoy food & hot work and work well with people and the experience needed. Earn \$7.50 an hour with training. Call Mr. Looney 281-8228

ABOVE AVERAGE? Big phone Co. needs inside sales reps to handle incoming calls. Day or Even. Full Time. \$5. Hr.-\$6.50 90 days. Some recent sales a must. No Fees. Employment Opps. 540-7235

ACCOUNTANT A challenging position has become available with CPA firm in Bloomfield area. 5 yrs. CPA firm experience required. Jerome S. Chapman, CPA, PC. 855-9610

ACCOUNTANT Expanding Firm Can CPA firm seeking ambitious Staff Level Accountant. 1 year public accounting experience. Enthusiastic, team player. Resume to: Dunn & Roth, 800 Fern Can. St. 1400, Detroit, MI 48243

ACCOUNTANT For local CPA office. 3-5 years public accounting experience. Computer knowledge helpful but not necessary. Charness & Stone, CPAs. 567-3533

ACCOUNTANT Immediate opening for an experienced Accountant to assume full charge of company's accounting functions. Duties will include handling books of original entry thru G/L, preparation of monthly financial statements and preparation of all payroll and sales tax returns. Challenging position for person possessing good judgment, self motivation, and the drive to succeed. Will work as part of a team and effective communication skills required. Generous salary and benefit package. For consideration, send confidential resume, and salary expectation, to: P.O. Box 963, Southfield, MI, 48071

500 Help Wanted

NEEDED BALL ROOM And Disco

Dancer-Performer over 20 for Male Dance Partner, with or without experience. Troy, Birmingham, Royal Oak area. 658-9450

BANK TELLERS \$5.35 per hr., full & part time. All areas available. Employer pays fee. Employment Center Agency 669-1635

BANK TELLER TRAINEE \$4.75/hr. Hiring Now 657-1200 Job Network Fee \$65

BANK TELLER TRAINEES-\$5.25 Hr. Paid Training, previous Part or recent Cashier experience. Tell time can go full. All areas. Fee Paid. Employment Center II. 540-4130

BARBER OR BEAUTICIAN Very busy Shop. "Share Your Hair". 27726 Plymouth Rd., Livonia 425-5440

BATH BOUTIQUE is in need of a part time Sales Person. Must enjoy working with people and coordinating colors. Apply Long's Fancy Bath Boutique, 190 E. Main St., Northville. An Equal Opportunity Employer.

BEAUTY CENTER Full service international beauty salon has openings for professional nail technicians, make-up Artist/Cosmetic sales people and Aestheticians. We offer salary, plus commission and company benefits. You should be self-motivated & able to promote yourself. Please apply in person at the Beauty Center, Hudson's 5th St. Oakland Mall.

BEAUTY OPERATORS. Southfield salon has 3 chairs available for rent. Also looking for full time manicurist. For more info call: 669-7919

BEAUTY SALON ASSISTANT needed for Birmingham area. Call Wed. thru Saturday: 646-1098

BLUE JEAN JOBS Apply Today, Work Tomorrow Must have own reliable car and phone. Plymouth, Livonia and Farmington Hills. Call today for appointment.

STAFF BUILDERS Temporary Personnel 425-TEMP

BOOKKEEPER AUTO DEALER needs experienced Bookkeeper with benefits. Call: Demmer Ford, 721-2800.

BOOKKEEPER/ADMINISTRATIVE ASSISTANT To President of small design, management and real estate development office in Troy, (Maple/Coolidge area). Luxurious surroundings. Long term opportunity. Substantial salary to qualified and motivated individual. Resume to Box 748, Observer & Eccentric Newspapers, 36251 Schoolcraft Rd., Livonia, Michigan 48150

BOOKKEEPER Full charge through general ledger. Experience required. Multi company, multi location manufacturer, located in Plymouth-Canton area. Responsible for all bookkeeping functions including payroll taxes. Excellent benefits. Salary commensurate with experience. Send resume or application accepted in person 10am-3pm at Personnel Dept., 8464 Ronda Dr., Canton MI 48187, (located 1/2 mile W. of Haggerty Rd., turn S. directly off Joy Rd.)

500 Help Wanted

MARKETING PROFESSIONAL

A leading Big-Accounting and Consulting Firm is looking for a marketing professional who desires a unique career opportunity in a highly challenging organization.

The ideal candidate will have a Bachelor's Degree in Marketing, Communications, or Related fields. Strong written and oral communications, data analysis, marketing research, and micro-computer skills are required.

Interested individuals should send their resume in confidence to:

NAS NATIONWIDE ADVERTISING SERVICE INC. NAS CONFIDENTIAL REPLY SERVICE 1056 Penobscot Building Department 6 DE 298MA Detroit, MI 48226 Our Client is An Equal Opportunity Employer

BUSINESS MANAGER FOR GROWING DOWNTOWN DETROIT LAW FIRM

Responsibilities include the supervision of the:

- BOOKKEEPER
- PERSONNEL MANAGER
- COMPUTER COORDINATOR

Probable candidate will have:

- ACCOUNTING EXPERTISE
- MANAGEMENT EXPERIENCE
- BE COMPUTER FRIENDLY

FUTURE GROWTH UNLIMITED PLEASE SEND RESUME TO: BOX 880

Observer & Eccentric Newspapers 36251 Schoolcraft Rd. Livonia, MI 48150

QUALITY CONTROL ENGINEER

Your future's in great shape with Federal-Mogul. We're a successful Fortune 500 company with multi-national operations which manufacture and distribute a wide variety of precision parts for the general industrial, aerospace, farm and construction equipment, truck and automotive industries, as well as for replacement markets. This NYSE listed firm operates 40 plants in more than 50 distribution centers and 3500 service facilities.

Our Quality Control Engineers are responsible for the development, implementation and maintenance of the quality control system. The successful candidate must have a B.S. degree in Mechanical Engineering with a minimum 2 years production quality control and part process control experience. Previous production quality control experience is a plus. A background in tubing, fitting, grinding, brazing or forging is desirable.

Send resume to: 20000 Woodward Ave., Dept. 5113, Detroit, MI 48217, (913) 885-2000

ASSISTANT MANAGER IF YOU ARE WILD & CRAZY AND NOT REAL LAZY

Then we're looking for 8 to 12 of you to fill various manager & rep positions. Must enjoy food & hot work and work well with people and the experience needed. Earn \$7.50 an hour with training. Call Mr. Looney 281-8228

ABOVE AVERAGE? Big phone Co. needs inside sales reps to handle incoming calls. Day or Even. Full Time. \$5. Hr.-\$6.50 90 days. Some recent sales a must. No Fees. Employment Opps. 540-7235

500 Help Wanted

BOOK STORE - Bus & Warehouse

Personnel, Part-time for orders, responsible adult. Must be personable & reliable. Pleasant atmosphere. Plymouth. 658-5250

BOX OFFICE Must be 18 yrs. or older. Math skills - A Must. Some typing involved. Apply: Abbey 4 Theatre, off I-75 & 14 Mile Rd.

BRIDGEPORT OPERATOR 3 years minimum experience. Must have own tools. Paid hospitalization, holidays and vacation. Westland area. 485-1100

500 Help Wanted

COUNTER CLERKS Full time, good pay & all benefits. Must be mature & reliable...

COUNTER HELP WANTED For Oak Park Koshar butcher shop. Immediate opening for the right person...

COUNTER PERSON, full time. Mature adult. Evenings & weekends. Salem Hills Golf course...

CUSTOMER SERVICE TRAINEE Do you enjoy working with people? Do you consider it important to be a customer service person?

CUSTOMER SERVICE Industrial distributor requires individual to maintain telephone & letter contact with customers...

CREDIT ANALYST Subsidiary of rapidly expanding Fortune 500 Company is seeking a person to join the Credit Analysis Staff...

DELIVERY DRIVERS needed for summer season. Class 2 license, and excellent driving record needed...

DELIVERY DRIVERS/STAFF HIRING NOW Call Today Job Network 557-1200 Fee \$85

DELIVERY PERSONS - up to \$8 hour. After 3 pm. Call 522-1751

DELIVERY PERSON to deliver tickets. Birmingham, Bloomfield, Troy, afternoons. Mon-Fri. Must have own car. Call Ann, 9-5. 644-5700

DELIVERY - REPAIR - SALES SERVICE - SALES REP We will train you & advance you thru each of the above steps to a high income sales career...

DELIVERY - SALES POSITION open for a Frozen Food Wholesaler in West Suburb. Sharp person with lots of energy - need only apply! P.O. Box 253, Northville, MI. 48167

DEMONSTRATORS Promotional demonstrators for cigarette promotion available July & August. Call: 354-8626

DISPATCHER - Experienced for ready mix concrete company. Resumes to: 2225 Wilcox Rd., Milford, MI 48042

DISPATCH TRAINEE Full-time, fast-paced work. Must have some relevant work experience & high school education. Hourly wage, benefits. Apply in person, June 26th, 2-5pm, at Eagle Expediting Inc., 8163 W. Grand River, Brighton

DO YOU WANT A JOB with on-the-job training? We have one designed for you. If you are an eligible Oakland County resident and sincerely want to work call 354-9167 NO FEE

500 Help Wanted

CUSTOMER SERVICE TRAINEE Do you enjoy working with people? Do you consider it important to be a customer service person?

CUSTOMER SERVICE Industrial distributor requires individual to maintain telephone & letter contact with customers...

CREDIT ANALYST Subsidiary of rapidly expanding Fortune 500 Company is seeking a person to join the Credit Analysis Staff...

DELIVERY DRIVERS needed for summer season. Class 2 license, and excellent driving record needed...

DELIVERY DRIVERS/STAFF HIRING NOW Call Today Job Network 557-1200 Fee \$85

DELIVERY PERSONS - up to \$8 hour. After 3 pm. Call 522-1751

DELIVERY PERSON to deliver tickets. Birmingham, Bloomfield, Troy, afternoons. Mon-Fri. Must have own car. Call Ann, 9-5. 644-5700

DELIVERY - REPAIR - SALES SERVICE - SALES REP We will train you & advance you thru each of the above steps to a high income sales career...

DELIVERY - SALES POSITION open for a Frozen Food Wholesaler in West Suburb. Sharp person with lots of energy - need only apply! P.O. Box 253, Northville, MI. 48167

DEMONSTRATORS Promotional demonstrators for cigarette promotion available July & August. Call: 354-8626

DISPATCHER - Experienced for ready mix concrete company. Resumes to: 2225 Wilcox Rd., Milford, MI 48042

DISPATCH TRAINEE Full-time, fast-paced work. Must have some relevant work experience & high school education. Hourly wage, benefits. Apply in person, June 26th, 2-5pm, at Eagle Expediting Inc., 8163 W. Grand River, Brighton

DO YOU WANT A JOB with on-the-job training? We have one designed for you. If you are an eligible Oakland County resident and sincerely want to work call 354-9167 NO FEE

500 Help Wanted

CUSTOMER SERVICE TRAINEE Do you enjoy working with people? Do you consider it important to be a customer service person?

CUSTOMER SERVICE Industrial distributor requires individual to maintain telephone & letter contact with customers...

CREDIT ANALYST Subsidiary of rapidly expanding Fortune 500 Company is seeking a person to join the Credit Analysis Staff...

DELIVERY DRIVERS needed for summer season. Class 2 license, and excellent driving record needed...

DELIVERY DRIVERS/STAFF HIRING NOW Call Today Job Network 557-1200 Fee \$85

DELIVERY PERSONS - up to \$8 hour. After 3 pm. Call 522-1751

DELIVERY PERSON to deliver tickets. Birmingham, Bloomfield, Troy, afternoons. Mon-Fri. Must have own car. Call Ann, 9-5. 644-5700

DELIVERY - REPAIR - SALES SERVICE - SALES REP We will train you & advance you thru each of the above steps to a high income sales career...

DELIVERY - SALES POSITION open for a Frozen Food Wholesaler in West Suburb. Sharp person with lots of energy - need only apply! P.O. Box 253, Northville, MI. 48167

DEMONSTRATORS Promotional demonstrators for cigarette promotion available July & August. Call: 354-8626

DISPATCHER - Experienced for ready mix concrete company. Resumes to: 2225 Wilcox Rd., Milford, MI 48042

DISPATCH TRAINEE Full-time, fast-paced work. Must have some relevant work experience & high school education. Hourly wage, benefits. Apply in person, June 26th, 2-5pm, at Eagle Expediting Inc., 8163 W. Grand River, Brighton

DO YOU WANT A JOB with on-the-job training? We have one designed for you. If you are an eligible Oakland County resident and sincerely want to work call 354-9167 NO FEE

500 Help Wanted

DESIGN SUPERVISOR Supervise design of machines to do automatic precision dimensional gaging, automatic Brinell & Rockwell testing & other handling systems for parts testing...

DESK CLERK needed - Full time position. Apply in person, Mon. thru Fri. 8am-4pm at Mercury Motor Inn, 22361 Michigan Ave., Dearborn. Call 374-1900

DESK CLERK/NIGHT AUDITOR Full time. Experience preferred. Barclay Inn, 145 So. Hunter Blvd. Birmingham. Call for an interview. 648-7300

DIE MAKER/DIE REPAIR Small stamping plant needs person capable of leading die repair operation. Competitive wages for experienced person. Apply in person, 9am-4pm, Groves Manufacturing 1170 Souter Blvd., Troy, MI.

DIETARY - accepting applications for Dietary Aides & Cooks for skilled nursing facility. Apply in person Mon thru Fri. 9am-5pm, Bloomfield Hills Care Center, 50 W. Square Lake Rd, Bloomfield Hills Mich

DIRECT CARE nurse, or background working with the handicapped. Apply for job teaching work skills to handicapped adults. This is a community-based program in the Troy area & requires some weekend work. Please contact Personnel for details. 338-8178 An Equal Opportunity Employer

DIRECT CARE NEEDED TO WORK with handicapped in group home. Southfield area. Part time, flexible hours. \$4.35 an hour to start. Must be 19 and have GED or high school diploma. Call between 9-3 Mon-Fri. 358-4285. An Equal Opportunity Employer

DIRECT CARE STAFF - full & part time positions available working with developmentally disabled. Westland area. Full & part-time. Must be at least 18 yrs. old & High School Grad. Start: \$4.15 an hour. Excellent benefits. Call 9-5pm. 525-7731

DIRECT CARE WORKERS - to work with mentally retarded adults in group homes. MORC training preferred. \$5.00 per hour plus benefits. Call Linda Tusa, West between 10 AM - 2 PM, 471-5810.

DIRECT CARE WORKERS Caring workers for group homes for mentally retarded adults in Livonia. Must have high school diploma or GED, and a good driving record. Must be at least 18. Minimum shift: weekend hours required. \$4.40-\$4.50 to start. DMH training preferred. Call Linda Tusa, West between 10 AM - 2 PM, 471-5810.

DISPATCHER - Experienced for ready mix concrete company. Resumes to: 2225 Wilcox Rd., Milford, MI 48042

DISPATCH TRAINEE Full-time, fast-paced work. Must have some relevant work experience & high school education. Hourly wage, benefits. Apply in person, June 26th, 2-5pm, at Eagle Expediting Inc., 8163 W. Grand River, Brighton

DO YOU WANT A JOB with on-the-job training? We have one designed for you. If you are an eligible Oakland County resident and sincerely want to work call 354-9167 NO FEE

500 Help Wanted

DISTRICT FIELD MANAGER needed for cleaning company to train & supervise cleaning crews. Experience with cleaning for other home services. Will involve residential & commercial accounts, window, carpet & upholstery cleaning. Applicants are encouraged to apply. Roadway Expressway is an affirmative action employer. An Equal Opportunity Employer

DOG GROOMER All breeds, part time, hours negotiable. Own equipment. 661-0458

DOG GROOMER Experienced. Redford area. 532-7083

DRAFTSMAN Farmington Hills precision metal machine shop has position open for person with extensive background in mechanical engineering type drafting. Capable of machine design & precision component detailing. Extensive board work, retiree welcome. Call 471-2300

DRAFTSMAN - Civil Engineering. Experienced Only! 731-8030

Draftsperson Automation part handling/storage systems and equipment. Send resume to: Tri-Mation, Inc. 30987 Industrial Rd. Livonia, MI 48150

DRAPERY SEWERS & CUTTERS Experienced for custom work room. 534-1777

DRIVER - DELIVERY PERSON to deliver automotive parts in Metro Detroit area. Person will drive our automatic pick-up truck. Full-time with many benefits. Call Steve Shepherd. 471-0044

DRIVER - Medical equipment & supply company. Full time. Reply to: Box 865, Observer & Eccentric Newspapers, 36251 Schoolcraft Rd., Livonia, Michigan 48150

DRIVER needed for Farmington Hills firm. Must be able to handle heavy equipment. Farmington Hills 737-9350

DRIVER/Retiree child care worker. Requires college education in human service area, or experience in working with children, C-3 license & familiar with Detroit & metro area. Responsible for care & transportation of children. Must be available evenings & weekends. Send resume to or complete application at St. Vincent & Sarah Fisher Center, 2747 E. 12 Mile, Farmington Hills, MI 48018. Attention Personnel. Call 265-1220

ELECTRO PLATING shop in Troy is looking for person for night shift. Work 55 hours per week. Call Tammy. 280-1185

ENGINEERING TECHNICIAN R & D lab in electronic/mechanical tech with hands on experience in hydraulics, pneumatics & instrumentation. Full benefits offered. Send resume to: ACE CONTROLS P O BOX 71 FARMINGTON, MI 48024 ATTENTION: H. WIARD

ENGINEER PROCESS ESTIMATOR A leading manufacturer of air control valves has immediate need for an individual experienced in MACHINE PARTS PROCESSING and COST ESTIMATING. Work centers include: manual lathe, mills, (CNC) turning, center and related assembly operations. Qualified candidate will possess at least 3 to 5 years in related experience. Competitive salary, coupled with outstanding benefits package. Send resume including salary history to: Dept. 5E, P. O. Box 837, Troy MI. 48099

FCC LICENSED TECHNICIAN - needed for Cellular Telephone Company. Southfield area. Immediate opening. Experience preferred. Excellent wages & benefits. Contact Don 358-3363

FCC LICENSED TECHNICIAN - needed for Cellular Telephone Company. Southfield area. Immediate opening. Experience preferred. Excellent wages & benefits. Contact Don 358-3363

500 Help Wanted

DRIVERS - Openings for part-time city drivers. Farmington - Southfield - Novi areas. C2 license required. Applications are being taken at: Roadway Expressway, 4726 Grand River, Novi, Wed. Thurs. 1:30 to 3:30pm. Qualified minority and/or female applicants are encouraged to apply. Roadway Expressway is an affirmative action employer. An Equal Opportunity Employer

DRIVERS with good driving record for ice cream street vending routes. Apply Penguin Ice Cream, 12-4PM, 34025 Schoolcraft Rd., Livonia. (W. of Farmington Rd.)

DRIVING INSTRUCTORS College certified to teach teens. Experience necessary. Full or part time. 478-3222

EDUCATION SPECIALIST Bachelor's Degree in Education, Guidance & Counseling, or related field. One year experience in educational system. Experience working with vocational education, adult education or other related programs. Demonstrated public speaking, writing and organizational abilities. Salary: \$13,254 per year. Application: 6-23-86 7-4-86 643-2550 EOE/M/F

ELECTRICIAN For Farmington Hills precision machinery a must. Good opportunity for the right person. Call 471-2300

ELECTRICIAN - minimum 5 yrs. experience in commercial, some residential, no others need apply. 557-5666

ELECTRICIAN Residential & Commercial & service work. 2 to 4 years experience required. Call 563-4300

ELECTRICIANS and Commercial Work. Call after 6pm. 563-7556

ELECTRONIC machine assemblers & packagers needed immediately for Troy Fortune 500 company. Top dollar, contract positions. Call John 646-7660

ELECTRONIC TECH Entry Level - \$10/HR Call Job Network 557-1200 Fee \$85

ELECTRONIC TECHNICIAN Experienced in trouble shooting circuit boards to component replacement level. Must be able to relate to customers when trouble shooting problems over phone lines, self motivation & initiative a must. If above qualifications can be met, please call 265-1220

ELECTRO PLATING shop in Troy is looking for person for night shift. Work 55 hours per week. Call Tammy. 280-1185

ENGINEERING TECHNICIAN R & D lab in electronic/mechanical tech with hands on experience in hydraulics, pneumatics & instrumentation. Full benefits offered. Send resume to: ACE CONTROLS P O BOX 71 FARMINGTON, MI 48024 ATTENTION: H. WIARD

ENGINEER PROCESS ESTIMATOR A leading manufacturer of air control valves has immediate need for an individual experienced in MACHINE PARTS PROCESSING and COST ESTIMATING. Work centers include: manual lathe, mills, (CNC) turning, center and related assembly operations. Qualified candidate will possess at least 3 to 5 years in related experience. Competitive salary, coupled with outstanding benefits package. Send resume including salary history to: Dept. 5E, P. O. Box 837, Troy MI. 48099

FCC LICENSED TECHNICIAN - needed for Cellular Telephone Company. Southfield area. Immediate opening. Experience preferred. Excellent wages & benefits. Contact Don 358-3363

FCC LICENSED TECHNICIAN - needed for Cellular Telephone Company. Southfield area. Immediate opening. Experience preferred. Excellent wages & benefits. Contact Don 358-3363

500 Help Wanted

ENJOY A CAREER in professional photo-finishing. No experience necessary. Raise & promotions based on performance. Starting pay \$3.65 per hour. Days: \$5.65 per hour; nights: \$3.85 per hour. Full benefit package includes: Life Insurance Health Insurance Pension Paid Vacation Paid Personal Days Weekly Production Bonus Classification Raises Semi Annual Raises Interested parties apply between 8:30am - 2:30pm at Guardian Photo, 43043 W 9 Mile Rd., Northville. Call for interview: 997-2662

ENJOY WORKING OUTSIDE? WE HAVE JOBS FOR YOU Lawn maintenance jobs are available in Ferndale, Royal Oak, Berkley and Mt. Clemens. No experience necessary. Reliable transportation is required.

NEVER A FEE BONUSES PAID VACATION Southfield 569-7500 Sterling Hts. 977-5740

Supplemental Staffing, Inc. The Temporary/Help People

Excellent Opportunities In Telemarketing

We need individuals with top-notch communication skills for immediate long term temporary assignments. 6 months experience necessary. Days & evenings available in Southfield & Birmingham.

PAID VACATIONS NEVER A FEE BONUSES 569-7500

Supplemental Staffing, Inc. The Temporary/Help People

FACTORY \$13.43/HR Hiring Now Call Today Job Network 557-1200 Fee \$85

FANTASTIC SUMMER EMPLOYMENT Safety/Information Officers

Do you enjoy working outdoors & dealing with the public? We have immediate openings. Excellent full & part time positions for college students. Applicants must possess a valid driver's license, working auto, high school grad, flexible hours. Apply in person only: Personnel Dept. Guardian Guard Service 20800 Southfield Rd., Southfield

FARM HELP WANTED Plymouth/Canton 459-4088 or 881-0688

FEMALE - DIRECT CARE STAFF for Group Home. MORC trained. \$4.25 per hour to start. Troy area 644-2235 Birmingham area 855-5137

FIELD SERVICE TECH major corporation needs service tech with some college background & knowledge of electronics. Proven track record a must. Benefits, expenses, salary \$16K. Fee paid. THE FISHER AGENCY INC. Employment Agency 477-9816

FIFTY IMMEDIATE OPENINGS Immediate openings with large janitorial company for new office buildings in Southfield and Farmington Hills. Experience helpful but not necessary. Part-time days and evenings. Good wages and advancement opportunities. Call for information 399-0708

500 Help Wanted

FILM PROCESSING - ALL SHIFTS Guardian Photo is currently seeking full time employees for all shifts. No experience necessary. We will train you. Days: \$5.65 per hour; nights: \$3.85 per hour. Full benefit package includes: Life Insurance Health Insurance Pension Paid Vacation Paid Personal Days Weekly Production Bonus Classification Raises Semi Annual Raises Interested parties apply between 8:30am - 2:30pm at Guardian Photo, 43043 W 9 Mile Rd., Northville. Call for interview: 997-2662

FIREWORKS STANDS short term temporary sales position. Earn salary plus commission. Send resume to: Call for interview: 997-2662

FIRST AIDER - CAMP near Traverse City needs mature person for first aid duties. Room, board, negotiable salary. \$48-2668 626-7023

FITNESS INSTRUCTORS Experienced in aerobics and stretch & tone. Knowledge of muscle groups essential. Health club, eves. W. Bloomfield, Sharon: 661-1000, ext. 328 or 301

FLORAL DESIGNER 1 yr. shop experience preferred, full & part time permanent positions. Apply in person FLOWERS FROM JOE'S 33018 W. 7 Mile Livonia

FLORIST SEEKS experienced Sales Person & college student. Earning potential of \$3,000 or \$4,000. Reliable transportation a must. If you are an aggressive, hardworking, self-motivated individual, are interested in this kind of work please call June 24th, between 10am-2pm. 848-1047

FOOD SERVICE WORKERS Part time. \$6.54 per hour Livonia area. 811, 484-5038

FOREMAN - small stamping plant - experienced in small automotive stamping & assembly. Competitive wages for experienced person. Apply in person, 9am-4pm, Groves Manufacturing, 1170 Souter Blvd., Troy, MI.

FORMICA APPLICATIONS for kitchen & bath cabinet shop. Experience preferred but will train responsible applicant. 422-1963

FOX PHOTO is looking for qualified delivery drivers to work 25-35 hrs per week. Must be 21 & be able to work weekends. \$4.01 per hr. with weekend premium. Medical & dental benefits. Please apply at AFB BLD, next to Butler Aviation, Willow Run Airport

FREE JOB PLACEMENT SERVICE - July 1986 positions available. Must be 18 years or older, live in Western Wayne County excluding Detroit & downriver residents. Funded by: WCPIC & JTPA. 277-2720

GROWING Farmington Hills Company has permanent opening for an experienced individual in the Shipping/Receiving department. Experience preferred but not required. Call Paul 477-6700

HAIR DESIGNERS Full and part time. Training provided. You may pay as self employed. Call, leave message. 348-6759

HAIR DRESSER or HAIR STYLIST. Experienced with clientele. East part of Troy. Good commission. Pleaseing working conditions. 977-8048

HAIR DRESSER - with some clientel. Northville area. Interested in salon. Full or part-time. Top commission paid. Call 642-8655

HAIR SALON in Farmington Hills needs Licensed Assistant or Shampooer. 651-9043

HAIR SALON needs Shampoo Assistant. Northville area. Must be dependable & licensed. 348-9270

HAIR STYLIST as part time receptionist in progressive salon. 425-9510

HAIR STYLIST - Experienced with clientele. Liberal commission, part or full-time. Canton Styling Room, ask for Pat. 881-4700

HAIR STYLIST Must be professional & well skilled. Assistant also needed. Livonia. 484-0022

HAIR STYLIST Full time. Minimum 5 years experience. Only those with following apply. 848-5410

HAIR STYLISTS - Variant's Hair Cutters (Plymouth), hiring with following. 55% commission. Paid vacation. Call: 453-5090

HAIR STYLISTS & MANICURIST - Consider the 3rd Street Hair Gallery opening soon in Rochester. Call Eugene, 652-3320 738-1749

HAIR STYLISTS WANTED - Plymouth - No clientele or just out of school? We provide guaranteed minimum, continuing education & paid vacations. Call: 456-0262

HAIR STYLISTS Interested in working full or part-time in busy S.W. Suburb Shopping Center. Call Shear Design, 977-9600

HAIR STYLIST Looking for salon change? Seeking a pleasant atmosphere & good working conditions? Then Call Birmingham Salon. 540-5644

500 Help Wanted

ATTENTION STUDENTS & HOMEMAKERS

Enjoy Summer with flexible hours while you earn extra money. GMS will be taking applications for 250 Packaging Jobs in Canton, Plymouth & Northville.

Must have own transportation, 16 & 17 year olds welcome with working papers.

Call for interview 427-7660

- Bring Along A Friend Most Of Our People Work 5 Days Per Week Cash Bonus

GENERAL MANAGEMENT SERVICES

14700 Farmington Rd. - Livonia Suite 104 Heritage Commons

NOW! Management Opportunities

If you have had 2 years college or equivalent 4 years managerial/supervisory experience and are a self-motivated, profit-oriented person, we'd like to talk to you. A strong math capability is important. Supermarket background would be a plus.

We have immediate opportunities in the Metro Detroit area for qualified persons to become mini market/service station managers and/or associate managers. Responsibilities include:

- Supervising operations Recruiting, hiring and training employees Expanding profits

Following a brief and successful training period covering accounting practices, retail marketing/merchandising and general business management policies related to food and beverage store operations, you would receive your first store assignment for a period of on-the-job training prior to being assigned a managerial position.

You will benefit from a compensation plan including sales incentive commissions. To learn more about the advantages of managing a GAS & GS facility, send a resume or letter explaining your experience, high energy level, high achiever attitude and business career goals to: Green O'S Company ATTN: Personnel Dept. 3000 E. Eureka Rd., Troy, MI 48068

On the way

QUALITY ASSURANCE MANAGER

Lindsay & Pavelich a leader in injection molding parts seeks qualified candidates to fill following positions:

QUALITY ASSURANCE MANAGER 4 to 6 years experience. Need motivated self assured individual with working knowledge of SPC, plastic molding background. Strong communication skills, ability to train and develop current staff necessary. Engineering degree a plus

FOREMEN 3-5 years injection molding experience, familiarization with hydraulics and automotive quality requirements. Must have good written and verbal communication skills.

Interested candidates send resume to: Gary Celestini Chivas Products Ltd. 42555 Merrill, Sterling Heights, MI. 48078

Move Into A Rewarding Sales Career With Merrill Lynch Realty

Our rapid growth in Michigan means career opportunities for sales professionals interested in representing the nation's pre-eminent real estate firm in Oakland County. Learn about our training program, facilities, and marketing concepts at a REAL ESTATE SEMINAR:

Somerset Inn 2601 W. Big Beaver Rd. Troy Thursday, June 26, 1986 7 P.M.

FOR RESERVATIONS CALL SANDY AT 540-7200

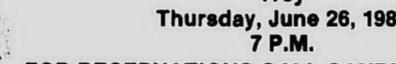

PART TIME DRIVERS



We have Driver openings available for independent Contractors in Garden City and Westland for men or women drivers. Must have truck, van or full size station wagon and be available on call for Monday and Thursday to drop off bundles of papers to Observer & Eccentric carriers.

Call the Observer & Eccentric Circulation Department Oakland County - 644-1100 Wayne County - 591-0500 An Equal Opportunity Employer

Data Processing Professionals

We have immediate openings for experienced professionals in the following positions:

TELEPROCESSING ANALYST: 3+ years of experience in troubleshooting and designing data communications networks. Experience with CICS, IBM equipment, and interconnect modems is required. Strong background in a large scale operations environment with IBM hardware required. Two plus years of college is preferred.

COMPUTER OPERATOR: Minimum of 2 years experience in a large scale IBM 308X MVS/JES multiprocessor shop. Operating knowledge of CICS, VTAM, TSO, JCL and UCC7 is essential. Some shift work is available.

PROGRAMMER ANALYST: Minimum of 3 years experience utilizing CICS in a large scale IBM 308X multiprocessor shop. Some shift work in an O/S/MVS environment required. Two plus years college is preferred.

The new position offers a high professional environment and an outstanding compensation and benefits plan. Send your resume with salary history requirements in complete confidence to: Box 874

500 Help Wanted

sears

PART TIME POSITIONS AVAILABLE

Experienced Seamstress Commission Sales Certified Tire/Battery Installer Flexible Hours & Weekends

</



500 Help Wanted
VENDING HELPER NEEDED
VIC TANNY women club of Plymouth is now hiring...

502 Help Wanted Dental-Medical
ATTENTION
High School graduates
Opportunities in Dental Technology field...

502 Help Wanted Dental-Medical
COMPUTER TRAINING
Self motivated person needed to train dental office personnel...

502 Help Wanted Dental-Medical
FARMINGTON HILLS dental office looking for career-minded, responsible person...

502 Help Wanted Dental-Medical
MEDICAL OFFICE MANAGER
New seeking broad diagnostic skills and excellent communication...

502 Help Wanted Dental-Medical
NURSES ARE BEAUTIFUL
Garden City Hospital, a 340 bed acute care teaching facility is seeking RNs and GNs...

502 Help Wanted Dental-Medical
RN'S
High pay rates
Full-time positions available in 500 company in Southfield & Detroit...

504 Help Wanted Office-Clerical
ACCOUNTING, filing & typing clerks
We need immediate openings for 3 former 500 company in Southfield & Detroit...

504 Help Wanted Office-Clerical
Head of The Rest
Temporary Assignments Available
If you desire choice assignments and possess a professional skill...

FREE JOBS
Immediate openings in Walled Lake/Wixom. NO EXPERIENCE NECESSARY...

DAVIS-SMITH
Medical Assistants
Medical Receptionists
Insurance Billers
Word Processors

DAVIS-SMITH
Medical Assistants
Medical Receptionists
Insurance Billers
Word Processors

DAVIS-SMITH
Medical Assistants
Medical Receptionists
Insurance Billers
Word Processors

DAVIS-SMITH
Medical Assistants
Medical Receptionists
Insurance Billers
Word Processors

DAVIS-SMITH
Medical Assistants
Medical Receptionists
Insurance Billers
Word Processors

DAVIS-SMITH
Medical Assistants
Medical Receptionists
Insurance Billers
Word Processors

DAVIS-SMITH
Medical Assistants
Medical Receptionists
Insurance Billers
Word Processors

DAVIS-SMITH
Medical Assistants
Medical Receptionists
Insurance Billers
Word Processors

Supplemental Staffing, Inc.
The Temporary Help People
\$1,200 per month to start, guaranteed for 30 hrs per week...

502 Help Wanted Dental-Medical
ADULT FOSTER CARE FACILITY
For the CLOSED HEAD INJURED has an opening in Program...

502 Help Wanted Dental-Medical
ADULT FOSTER CARE FACILITY
For the CLOSED HEAD INJURED has an opening in Program...

502 Help Wanted Dental-Medical
ADULT FOSTER CARE FACILITY
For the CLOSED HEAD INJURED has an opening in Program...

502 Help Wanted Dental-Medical
ADULT FOSTER CARE FACILITY
For the CLOSED HEAD INJURED has an opening in Program...

502 Help Wanted Dental-Medical
ADULT FOSTER CARE FACILITY
For the CLOSED HEAD INJURED has an opening in Program...

502 Help Wanted Dental-Medical
ADULT FOSTER CARE FACILITY
For the CLOSED HEAD INJURED has an opening in Program...

502 Help Wanted Dental-Medical
ADULT FOSTER CARE FACILITY
For the CLOSED HEAD INJURED has an opening in Program...

502 Help Wanted Dental-Medical
ADULT FOSTER CARE FACILITY
For the CLOSED HEAD INJURED has an opening in Program...

QUALITY ASSURANCE TECHNICIAN
We are seeking a qualified ART, RN or LPN for the challenging position of Quality Assurance Technician.

DIETARY PART TIME POSITIONS
We are seeking a qualified ART, RN or LPN for the challenging position of Dietary Technician.

PHLEBOTOMIST
Several part-time openings. Weekend or early morning shifts available. Must be able to train full time.

Mount Carmel Mercy Hospital
Medical Secretary/Transcriptionist
St. Joseph Mercy Hospital, a unit of Catherine McAuley Health Center...

ENTECH SERVICES, LTD.
Head of The Rest
Temporary Assignments Available
If you desire choice assignments and possess a professional skill...

504 Help Wanted Office-Clerical

BOOKKEEPER ASSISTANT Full time position. Good typing skills. Must be able to handle ground. Data entry experience a plus. Marston 825-1800

BOOKKEEPER Experienced in payroll, accounts receivable & customer service for doctor's office in Dearborn. Phone 884-1041

BOOKKEEPER/OPERATOR needed for Birmingham Law Firm. Computer skills. Call Mr. Thompson, 846-5440

BOOKKEEPER - full time, A/R, A/P computer skills required. Southfield area. Ask for Jan 899-8280

BOOKKEEPER - Full Charge, experienced only, full time, busy Southfield general contractor firm. Good salary & benefits. Call after 12 noon 268-5102

BOOKKEEPER Full charge, experienced in payroll, accounts receivable, bank reconciliation, light typing required. Call 825-2528

BOOKKEEPER - Part time. Canton. Experience on general ledger, accounts receivable, bank payroll. Light typing required. Call 825-2528

BOOKKEEPER ASSISTANT position available. Full or part-time, math must be accurate. Data entry experience helpful but not necessary. Apply at Ramchargers Automotive Center, 36584 Plymouth Rd., Livonia.

BOOKKEEPER/Secretary. Must have some experience with computer. Accounts receivable, bank reconciliation and payroll. 865-8384

BOOKKEEPER/SECRETARY Experienced - for (1) Girl Office Property Management firm. 877-1711

BOOKKEEPER/SECRETARY Small office. No phone. Salary & working conditions. Good benefits. Call SAM-3PM 884-5440

BOOKKEEPER Experienced and responsible clerk needed to handle payroll and accounting duties thru unadjusted trial balance for multi-company operations. Good pay, good benefits. 825-0756

BOOKKEEPER thru Trial Balance. No phone. Experience required. Prefer construction industry experience. Computer experience helpful. Will work with IBM/P.C. Troy. Good salary & benefits. 865-8384

BOOKKEEPER through Trial Balance. Mature person. Immediate opening, full time. Call 865-8384

BOOKKEEPER - with full charge experience required, part time, for Birmingham architectural firm. Call 644-0804

BOOKKEEPING Experienced in A/R, A/P, payroll, statements, etc. Must be able to work with EDP applications and manufacturing helpful. Need to be flexible, personable and diligent. Send resume with salary required to: Controller, Perfection Automotive Products, 12445 Lavan Rd., Livonia, MI 48150.

BRANCH MANAGERS SECRETARY \$18,000 Be part of a Fortune 500 company and enjoy all the benefits that go with it. You'll need top secretarial skills and experience for this top paid opportunity. Call 825-2528

After 5 Appointments Available SNELLING & SNELLING

BUSINESS CENTER OFFICE MGR. Southfield business center has immediate opening for mature, experienced secretary for a busy, responsible full-time position. Must have superior grammar/secretarial skills & word processing knowledge. Job entails real estate, insurance & is extremely people oriented. Call Mrs. Layne 352-2982

BUSY FARMINGTON HILLS Real Estate office looking for experienced receptionist. Light typing weekends. Ask for Rose Anne 861-6700

BUSY SOUTHFIELD advertising agency is looking for a sharp secretary. Excellent benefits. Good salary & benefits. Requirement of a minimum of 70 WPM. Positive attitude and pleasant disposition. Please send resume to: Observer & Eccentric Newspapers, 36251 Schoolcraft Rd., Livonia, Michigan 48150

CAN WE TALK? OPEN HOUSE WED., JUNE 25 THURS., JUNE 26 5PM - 8PM

Legal to \$23,000 Executive secretary to \$19,700 Secretary to \$17,000 Receptionist to \$12,000 Word Processing to \$10,000 Accounting Clerk to \$13,500

Our personal consultants will be happy to discuss your situation and other career opportunities that are available to you. We specialize in office clerical placement.

All Fees Company Paid PERMANENT STAFF 37789 Professional Center Dr. Livonia 861-2221

CASHIER, PART TIME automatic dispenser of a portable time clock, 1pm-5pm, Mon. thru Thurs. Applications now being taken at Jack Cashey Chevrolet 7020 Orchard Lake Rd., W. Bloomfield.

CLERICAL HELP Part time, 30 hours a week from 8 AM - 12 PM. Clerical help needed in Shipping & Receiving Department. Telephone, filing, and some calculator experience helpful. Apply at the Seven Up/R/C/Canada Dry Bottling Co. of Detroit, 12251 Grand River Rd., Redford, MI, 48238. No phone calls please. Equal Opportunity Employer M/F/H

CLERICAL HELP - Part Time Approximately 25 hrs per week. Duties include: typing, phone, record keeping, etc. Student welcome. Nice Southfield office. Call Bonnie 362-3660

CLERICAL (Part-Time) Our Collection Administration Department is seeking a dependable individual with accurate typing of 40-50 wpm and excellent communication skills. Position involves a variety of clerical duties including typing, filing, copying and customer service. Working hours will be 10am-6:45pm Mon-Fri. Ability to work under pressure a must. Openings existing in plus individuals must be willing to work additional hours when needed. We offer a complete benefit package. Detailed resume apply Mon-Fri 9 am-4 pm.

The Personnel Department MANUFACTURERS HANOVER MORTGAGE CORPORATION 27895 Farmington Road Farmington Hills, MI 48019 (Corner of 12th Rd.)

An Equal Opportunity/Affirmative Action Employer M/F/H

CLERICAL - permanent part time, for M/F & A/R clerical position. No benefits. Must have 5-6 years experience. Must be able to handle a variety of clerical duties. Please apply in person at: Michigan National Bank, 29777 Telegraph Rd. (N. of 12 Mile) Southfield or call 354-8195

CLERICAL (Part-Time) Our Collection Administration Department is seeking a dependable individual with accurate typing of 40-50 wpm and excellent communication skills. Position involves a variety of clerical duties including typing, filing, copying and customer service. Working hours will be 10am-6:45pm Mon-Fri. Ability to work under pressure a must. Openings existing in plus individuals must be willing to work additional hours when needed. We offer a complete benefit package. Detailed resume apply Mon-Fri 9 am-4 pm.

The Personnel Department MANUFACTURERS HANOVER MORTGAGE CORPORATION 27895 Farmington Road Farmington Hills, MI 48019 (Corner of 12th Rd.)

An Equal Opportunity/Affirmative Action Employer M/F/H

CLERICAL - permanent part time, for M/F & A/R clerical position. No benefits. Must have 5-6 years experience. Must be able to handle a variety of clerical duties. Please apply in person at: Michigan National Bank, 29777 Telegraph Rd. (N. of 12 Mile) Southfield or call 354-8195

CLERICAL (Part-Time) Our Collection Administration Department is seeking a dependable individual with accurate typing of 40-50 wpm and excellent communication skills. Position involves a variety of clerical duties including typing, filing, copying and customer service. Working hours will be 10am-6:45pm Mon-Fri. Ability to work under pressure a must. Openings existing in plus individuals must be willing to work additional hours when needed. We offer a complete benefit package. Detailed resume apply Mon-Fri 9 am-4 pm.

The Personnel Department MANUFACTURERS HANOVER MORTGAGE CORPORATION 27895 Farmington Road Farmington Hills, MI 48019 (Corner of 12th Rd.)

An Equal Opportunity/Affirmative Action Employer M/F/H

CLERICAL - permanent part time, for M/F & A/R clerical position. No benefits. Must have 5-6 years experience. Must be able to handle a variety of clerical duties. Please apply in person at: Michigan National Bank, 29777 Telegraph Rd. (N. of 12 Mile) Southfield or call 354-8195

CLERICAL (Part-Time) Our Collection Administration Department is seeking a dependable individual with accurate typing of 40-50 wpm and excellent communication skills. Position involves a variety of clerical duties including typing, filing, copying and customer service. Working hours will be 10am-6:45pm Mon-Fri. Ability to work under pressure a must. Openings existing in plus individuals must be willing to work additional hours when needed. We offer a complete benefit package. Detailed resume apply Mon-Fri 9 am-4 pm.

The Personnel Department MANUFACTURERS HANOVER MORTGAGE CORPORATION 27895 Farmington Road Farmington Hills, MI 48019 (Corner of 12th Rd.)

An Equal Opportunity/Affirmative Action Employer M/F/H

CLERICAL - permanent part time, for M/F & A/R clerical position. No benefits. Must have 5-6 years experience. Must be able to handle a variety of clerical duties. Please apply in person at: Michigan National Bank, 29777 Telegraph Rd. (N. of 12 Mile) Southfield or call 354-8195

CLERICAL (Part-Time) Our Collection Administration Department is seeking a dependable individual with accurate typing of 40-50 wpm and excellent communication skills. Position involves a variety of clerical duties including typing, filing, copying and customer service. Working hours will be 10am-6:45pm Mon-Fri. Ability to work under pressure a must. Openings existing in plus individuals must be willing to work additional hours when needed. We offer a complete benefit package. Detailed resume apply Mon-Fri 9 am-4 pm.

The Personnel Department MANUFACTURERS HANOVER MORTGAGE CORPORATION 27895 Farmington Road Farmington Hills, MI 48019 (Corner of 12th Rd.)

An Equal Opportunity/Affirmative Action Employer M/F/H

CLERICAL - permanent part time, for M/F & A/R clerical position. No benefits. Must have 5-6 years experience. Must be able to handle a variety of clerical duties. Please apply in person at: Michigan National Bank, 29777 Telegraph Rd. (N. of 12 Mile) Southfield or call 354-8195

CLERICAL (Part-Time) Our Collection Administration Department is seeking a dependable individual with accurate typing of 40-50 wpm and excellent communication skills. Position involves a variety of clerical duties including typing, filing, copying and customer service. Working hours will be 10am-6:45pm Mon-Fri. Ability to work under pressure a must. Openings existing in plus individuals must be willing to work additional hours when needed. We offer a complete benefit package. Detailed resume apply Mon-Fri 9 am-4 pm.

The Personnel Department MANUFACTURERS HANOVER MORTGAGE CORPORATION 27895 Farmington Road Farmington Hills, MI 48019 (Corner of 12th Rd.)

An Equal Opportunity/Affirmative Action Employer M/F/H

CLERICAL - permanent part time, for M/F & A/R clerical position. No benefits. Must have 5-6 years experience. Must be able to handle a variety of clerical duties. Please apply in person at: Michigan National Bank, 29777 Telegraph Rd. (N. of 12 Mile) Southfield or call 354-8195

CLERICAL (Part-Time) Our Collection Administration Department is seeking a dependable individual with accurate typing of 40-50 wpm and excellent communication skills. Position involves a variety of clerical duties including typing, filing, copying and customer service. Working hours will be 10am-6:45pm Mon-Fri. Ability to work under pressure a must. Openings existing in plus individuals must be willing to work additional hours when needed. We offer a complete benefit package. Detailed resume apply Mon-Fri 9 am-4 pm.

The Personnel Department MANUFACTURERS HANOVER MORTGAGE CORPORATION 27895 Farmington Road Farmington Hills, MI 48019 (Corner of 12th Rd.)

An Equal Opportunity/Affirmative Action Employer M/F/H

CLERICAL - permanent part time, for M/F & A/R clerical position. No benefits. Must have 5-6 years experience. Must be able to handle a variety of clerical duties. Please apply in person at: Michigan National Bank, 29777 Telegraph Rd. (N. of 12 Mile) Southfield or call 354-8195

CLERICAL (Part-Time) Our Collection Administration Department is seeking a dependable individual with accurate typing of 40-50 wpm and excellent communication skills. Position involves a variety of clerical duties including typing, filing, copying and customer service. Working hours will be 10am-6:45pm Mon-Fri. Ability to work under pressure a must. Openings existing in plus individuals must be willing to work additional hours when needed. We offer a complete benefit package. Detailed resume apply Mon-Fri 9 am-4 pm.

The Personnel Department MANUFACTURERS HANOVER MORTGAGE CORPORATION 27895 Farmington Road Farmington Hills, MI 48019 (Corner of 12th Rd.)

An Equal Opportunity/Affirmative Action Employer M/F/H

CLERICAL - permanent part time, for M/F & A/R clerical position. No benefits. Must have 5-6 years experience. Must be able to handle a variety of clerical duties. Please apply in person at: Michigan National Bank, 29777 Telegraph Rd. (N. of 12 Mile) Southfield or call 354-8195

CLERICAL (Part-Time) Our Collection Administration Department is seeking a dependable individual with accurate typing of 40-50 wpm and excellent communication skills. Position involves a variety of clerical duties including typing, filing, copying and customer service. Working hours will be 10am-6:45pm Mon-Fri. Ability to work under pressure a must. Openings existing in plus individuals must be willing to work additional hours when needed. We offer a complete benefit package. Detailed resume apply Mon-Fri 9 am-4 pm.

504 Help Wanted Office-Clerical

CLERICAL. Fast growing firm needs bright, outgoing person to handle clerical duties. Light typing. 9:30am-12 noon. Marston/Stephenson Hwy. area. 865-8384

CLERK Full time position for an experienced clerk. Must have good organizational skills, be attentive to detail, common sense and the ability to work independently. Excellent benefits and salary. Qualified candidates send resume and salary requirements to: ADISTRA CORP. 101 Union St. Plymouth, MI 48170

CLERK Insurance company, Southfield is seeking applications for general clerical work. 1 year office clerical background. Candidates must possess excellent typing (45-50 wpm), filing and communication skills. Data entry experience desired. Excellent benefits package. Apply, Mon. thru Fri. 9am to 4pm, Leverage Insurance Companies, 16500 Providence St., Southfield (across from the American Theatre)

Clerk-Typist Immediate openings available to work at our office located in Farmington Hills on 12 miles at Farmington Hills on 12 miles at Farmington Hills. Candidates should type accurately minimum 50 WPM and have the ability to deal effectively with business machines and office equipment. Apply in person 10am-3pm Mon-Fri.

First Federal of Michigan An Equal Opportunity Employer Farmington Hills

CLERK/TYPIST (Part-Time) We are seeking an individual to work a flexible 18 hours per week in our marketing division. However, individual must be able to work full time (36 hours per week) from June through September. Responsibilities include numeric filing, copying, accurate typing, CRT input, record keeping and various other office duties. Qualified candidate must possess accurate typing of 30-40 wpm and have good mathematical and organizational skills.

Interested candidates should apply Mon-Fri, 9am-4pm. The Personnel Department MANUFACTURERS HANOVER MORTGAGE CORPORATION 27895 Farmington Road Farmington Hills, MI 48019 (Corner of 12th Rd.)

An Equal Opportunity/Affirmative Action Employer M/F/H

COLLEGE STUDENT Full time file clerk needed for summer benefits super hours. CALL TODAY. Evening hours available. All Our Fees Are Company Paid

PERMANENT STAFF LIVONIA 581-2221 SOUTHFIELD 382-4000 TROY 382-4000 SOUTHWEST SUBURB 298-8800 ST. CLAIR SHORES 298-8800

COST ANALYST Experience required for a well established, multi-plant tool manufacturer. Excellent compensation & benefit package. Please send resume: Accounting Dept., P.O. Box 378, Farmington Hills, MI 48024. An Equal Opportunity Employer

COUNTER-BILLING CLERK Sharp, pleasant personality, good math, phone, billing, light typing & bookkeeping, 5 day week, benefits, \$8.50 per hour to start. Livonia. For consideration, call 865-8384

CRIT OPERATOR to handle computer reports, recording, po's & inventory adjustments. Needs good business image & knowledge of computer. Please send resume to: Curtin, Matheson, Scientific 45400 Helm, Plymouth, Michigan, 48170. Attention Mr. Frost. Equal Opportunity Employer M/F

Customer Service Downtown Branch of national temporary help agency seeking individuals oriented, self-motivated individual to join our successful team. Outside sales experience helpful. Please call 865-8384 for a personal interview.

CUSTOMER SERVICE REP \$11,440 FEE PAID Benefits, nice suburban office requires: daily entry, 1-2 years office experience. Good typing, math and grammar. Call 396-3450. SNELLING & SNELLING

504 Help Wanted Office-Clerical

RECEPTIONIST DOWNTOWN Michigan National Bank is accepting applications for our new office at the Stroh's Riverplace. Must possess excellent communication skill and the ability to greet and direct professional visitors and customers. Please apply in person at: Michigan National Corporation 29777 Telegraph Rd. (N. of 12 Mile) Southfield or call 354-8195

ACCOUNTING CLERK This opening at our Product Development Center in Troy represents an excellent opportunity to demonstrate your accounting skills in a professional environment as an Accounting Clerk with at least one year of business experience and a basic understanding of accounting principles. Completion of college level courses in accounting is a plus. Accurate typing skills of 30 wpm are necessary. We offer a competitive salary and benefit package. For confidential consideration please submit resume indicating salary history to: BOX 862 Equal Opportunity Employer

ACCOUNTING CLERK This opening at our Product Development Center in Troy represents an excellent opportunity to demonstrate your accounting skills in a professional environment as an Accounting Clerk with at least one year of business experience and a basic understanding of accounting principles. Completion of college level courses in accounting is a plus. Accurate typing skills of 30 wpm are necessary. We offer a competitive salary and benefit package. For confidential consideration please submit resume indicating salary history to: BOX 862 Equal Opportunity Employer

ACCOUNTING CLERK This opening at our Product Development Center in Troy represents an excellent opportunity to demonstrate your accounting skills in a professional environment as an Accounting Clerk with at least one year of business experience and a basic understanding of accounting principles. Completion of college level courses in accounting is a plus. Accurate typing skills of 30 wpm are necessary. We offer a competitive salary and benefit package. For confidential consideration please submit resume indicating salary history to: BOX 862 Equal Opportunity Employer

ACCOUNTING CLERK This opening at our Product Development Center in Troy represents an excellent opportunity to demonstrate your accounting skills in a professional environment as an Accounting Clerk with at least one year of business experience and a basic understanding of accounting principles. Completion of college level courses in accounting is a plus. Accurate typing skills of 30 wpm are necessary. We offer a competitive salary and benefit package. For confidential consideration please submit resume indicating salary history to: BOX 862 Equal Opportunity Employer

ACCOUNTING CLERK This opening at our Product Development Center in Troy represents an excellent opportunity to demonstrate your accounting skills in a professional environment as an Accounting Clerk with at least one year of business experience and a basic understanding of accounting principles. Completion of college level courses in accounting is a plus. Accurate typing skills of 30 wpm are necessary. We offer a competitive salary and benefit package. For confidential consideration please submit resume indicating salary history to: BOX 862 Equal Opportunity Employer

ACCOUNTING CLERK This opening at our Product Development Center in Troy represents an excellent opportunity to demonstrate your accounting skills in a professional environment as an Accounting Clerk with at least one year of business experience and a basic understanding of accounting principles. Completion of college level courses in accounting is a plus. Accurate typing skills of 30 wpm are necessary. We offer a competitive salary and benefit package. For confidential consideration please submit resume indicating salary history to: BOX 862 Equal Opportunity Employer

ACCOUNTING CLERK This opening at our Product Development Center in Troy represents an excellent opportunity to demonstrate your accounting skills in a professional environment as an Accounting Clerk with at least one year of business experience and a basic understanding of accounting principles. Completion of college level courses in accounting is a plus. Accurate typing skills of 30 wpm are necessary. We offer a competitive salary and benefit package. For confidential consideration please submit resume indicating salary history to: BOX 862 Equal Opportunity Employer

ACCOUNTING CLERK This opening at our Product Development Center in Troy represents an excellent opportunity to demonstrate your accounting skills in a professional environment as an Accounting Clerk with at least one year of business experience and a basic understanding of accounting principles. Completion of college level courses in accounting is a plus. Accurate typing skills of 30 wpm are necessary. We offer a competitive salary and benefit package. For confidential consideration please submit resume indicating salary history to: BOX 862 Equal Opportunity Employer

ACCOUNTING CLERK This opening at our Product Development Center in Troy represents an excellent opportunity to demonstrate your accounting skills in a professional environment as an Accounting Clerk with at least one year of business experience and a basic understanding of accounting principles. Completion of college level courses in accounting is a plus. Accurate typing skills of 30 wpm are necessary. We offer a competitive salary and benefit package. For confidential consideration please submit resume indicating salary history to: BOX 862 Equal Opportunity Employer

ACCOUNTING CLERK This opening at our Product Development Center in Troy represents an excellent opportunity to demonstrate your accounting skills in a professional environment as an Accounting Clerk with at least one year of business experience and a basic understanding of accounting principles. Completion of college level courses in accounting is a plus. Accurate typing skills of 30 wpm are necessary. We offer a competitive salary and benefit package. For confidential consideration please submit resume indicating salary history to: BOX 862 Equal Opportunity Employer

ACCOUNTING CLERK This opening at our Product Development Center in Troy represents an excellent opportunity to demonstrate your accounting skills in a professional environment as an Accounting Clerk with at least one year of business experience and a basic understanding of accounting principles. Completion of college level courses in accounting is a plus. Accurate typing skills of 30 wpm are necessary. We offer a competitive salary and benefit package. For confidential consideration please submit resume indicating salary history to: BOX 862 Equal Opportunity Employer

ACCOUNTING CLERK This opening at our Product Development Center in Troy represents an excellent opportunity to demonstrate your accounting skills in a professional environment as an Accounting Clerk with at least one year of business experience and a basic understanding of accounting principles. Completion of college level courses in accounting is a plus. Accurate typing skills of 30 wpm are necessary. We offer a competitive salary and benefit package. For confidential consideration please submit resume indicating salary history to: BOX 862 Equal Opportunity Employer

ACCOUNTING CLERK This opening at our Product Development Center in Troy represents an excellent opportunity to demonstrate your accounting skills in a professional environment as an Accounting Clerk with at least one year of business experience and a basic understanding of accounting principles. Completion of college level courses in accounting is a plus. Accurate typing skills of 30 wpm are necessary. We offer a competitive salary and benefit package. For confidential consideration please submit resume indicating salary history to: BOX 862 Equal Opportunity Employer

ACCOUNTING CLERK This opening at our Product Development Center in Troy represents an excellent opportunity to demonstrate your accounting skills in a professional environment as an Accounting Clerk with at least one year of business experience and a basic understanding of accounting principles. Completion of college level courses in accounting is a plus. Accurate typing skills of 30 wpm are necessary. We offer a competitive salary and benefit package. For confidential consideration please submit resume indicating salary history to: BOX 862 Equal Opportunity Employer

ACCOUNTING CLERK This opening at our Product Development Center in Troy represents an excellent opportunity to demonstrate your accounting skills in a professional environment as an Accounting Clerk with at least one year of business experience and a basic understanding of accounting principles. Completion of college level courses in accounting is a plus. Accurate typing skills of 30 wpm are necessary. We offer a competitive salary and benefit package. For confidential consideration please submit resume indicating salary history to: BOX 862 Equal Opportunity Employer

ACCOUNTING CLERK This opening at our Product Development Center in Troy represents an excellent opportunity to demonstrate your accounting skills in a professional environment as an Accounting Clerk with at least one year of business experience and a basic understanding of accounting principles. Completion of college level courses in accounting is a plus. Accurate typing skills of 30 wpm are necessary. We offer a competitive salary and benefit package. For confidential consideration please submit resume indicating salary history to: BOX 862 Equal Opportunity Employer

ACCOUNTING CLERK This opening at our Product Development Center in Troy represents an excellent opportunity to demonstrate your accounting skills in a professional environment as an Accounting Clerk with at least one year of business experience and a basic understanding of accounting principles. Completion of college level courses in accounting is a plus. Accurate typing skills of 30 wpm are necessary. We offer a competitive salary and benefit package. For confidential consideration please submit resume indicating salary history to: BOX 862 Equal Opportunity Employer

ACCOUNTING CLERK This opening at our Product Development Center in Troy represents an excellent opportunity to demonstrate your accounting skills in a professional environment as an Accounting Clerk with at least one year of business experience and a basic understanding of accounting principles. Completion of college level courses in accounting is a plus. Accurate typing skills of 30 wpm are necessary. We offer a competitive salary and benefit package. For confidential consideration please submit resume indicating salary history to: BOX 862 Equal Opportunity Employer

ACCOUNTING CLERK This opening at our Product Development Center in Troy represents an excellent opportunity to demonstrate your accounting skills in a professional environment as an Accounting Clerk with at least one year of business experience and a basic understanding of accounting principles. Completion of college level courses in accounting is a plus. Accurate typing skills of 30 wpm are necessary. We offer a competitive salary and benefit package. For confidential consideration please submit resume indicating salary history to: BOX 862 Equal Opportunity Employer

ACCOUNTING CLERK This opening at our Product Development Center in Troy represents an excellent opportunity to demonstrate your accounting skills in a professional environment as an Accounting Clerk with at least one year of business experience and a basic understanding of accounting principles. Completion of college level courses in accounting is a plus. Accurate typing skills of 30 wpm are necessary. We offer a competitive salary and benefit package. For confidential consideration please submit resume indicating salary history to: BOX 862 Equal Opportunity Employer

ACCOUNTING CLERK This opening at our Product Development Center in Troy represents an excellent opportunity to demonstrate your accounting skills in a professional environment as an Accounting Clerk with at least one year of business experience and a basic understanding of accounting principles. Completion of college level courses in accounting is a plus. Accurate typing skills of 30 wpm are necessary. We offer a competitive salary and benefit package. For confidential consideration please submit resume indicating salary history to: BOX 862 Equal Opportunity Employer

ACCOUNTING CLERK This opening at our Product Development Center in Troy represents an excellent opportunity to demonstrate your accounting skills in a professional environment as an Accounting Clerk with at least one year of business experience and a basic understanding of accounting principles. Completion of college level courses in accounting is a plus. Accurate typing skills of 30 wpm are necessary. We offer a competitive salary and benefit package. For confidential consideration please submit resume indicating salary history to: BOX 862 Equal Opportunity Employer

ACCOUNTING CLERK This opening at our Product Development Center in Troy represents an excellent opportunity to demonstrate your accounting skills in a professional environment as an Accounting Clerk with at least one year of business experience and a basic understanding of accounting principles. Completion of college level courses in accounting is a plus. Accurate typing skills of 30 wpm are necessary. We offer a competitive salary and benefit package. For confidential consideration please submit resume indicating salary history to: BOX 862 Equal Opportunity Employer

ACCOUNTING CLERK This opening at our Product Development Center in Troy represents an excellent opportunity to demonstrate your accounting skills in a professional environment as an Accounting Clerk with at least one year of business experience and a basic understanding of accounting principles. Completion of college level courses in accounting is a plus. Accurate typing skills of 30 wpm are necessary. We offer a competitive salary and benefit package. For confidential consideration please submit resume indicating salary history to: BOX 862 Equal Opportunity Employer

ACCOUNTING CLERK This opening at our Product Development Center in Troy represents an excellent opportunity to demonstrate your accounting skills in a professional environment as an Accounting Clerk with at least one year of business experience and a basic understanding of accounting principles. Completion of college level courses in accounting is a plus. Accurate typing skills of 30 wpm are necessary. We offer a competitive salary and benefit package. For confidential consideration please submit resume indicating salary history to: BOX 862 Equal Opportunity Employer

ACCOUNTING CLERK This opening at our Product Development Center in Troy represents an excellent opportunity to demonstrate your accounting skills in a professional environment as an Accounting Clerk with at least one year of business experience and a basic understanding of accounting principles. Completion of college level courses in accounting is a plus. Accurate typing skills of 30 wpm are necessary. We offer a competitive salary and benefit package. For confidential consideration please submit resume indicating salary history to: BOX 862 Equal Opportunity Employer

ACCOUNTING CLERK This opening at our Product Development Center in Troy represents an excellent opportunity to demonstrate your accounting skills in a professional environment as an Accounting Clerk with at least one year of business experience and a basic understanding of accounting principles. Completion of college level courses in accounting is a plus. Accurate typing skills of 30 wpm are necessary. We offer a competitive salary and benefit package. For confidential consideration please submit resume indicating salary history to: BOX 862 Equal Opportunity Employer

ACCOUNTING CLERK This opening at our Product Development Center in Troy represents an excellent opportunity to demonstrate your accounting skills in a professional environment as an Accounting Clerk with at least one year of business experience and a basic understanding of accounting principles. Completion of college level courses in accounting is a plus. Accurate typing skills of 30 wpm are necessary. We offer a competitive salary and benefit package. For confidential consideration please submit resume indicating salary history to: BOX 862 Equal Opportunity Employer

ACCOUNTING CLERK This opening at our Product Development Center in Troy represents an excellent opportunity to demonstrate your accounting skills in a professional environment as an Accounting Clerk with at least one year of business experience and a basic understanding of accounting principles. Completion of college level courses in accounting is a plus. Accurate typing skills of 30 wpm are necessary. We offer a competitive salary and benefit package. For confidential consideration please submit resume indicating salary history to: BOX 862 Equal Opportunity Employer

ACCOUNTING CLERK This opening at our Product Development Center in Troy represents an excellent opportunity to demonstrate your accounting skills in a professional environment as an Accounting Clerk with at least one year of business experience and a basic understanding of accounting principles. Completion of college level courses in accounting is a plus. Accurate typing skills of 30 wpm are necessary. We offer a competitive salary and benefit package. For confidential consideration please submit resume indicating salary history to: BOX 862 Equal Opportunity Employer

ACCOUNTING CLERK This opening at our Product Development Center in Troy represents an excellent opportunity to demonstrate your accounting skills in a professional environment as an Accounting Clerk with at least one year of business experience and a basic understanding of accounting principles. Completion of college level courses in accounting is a plus. Accurate typing skills of 30 wpm are necessary. We offer a competitive salary and benefit package. For confidential consideration please submit resume indicating salary history to: BOX 862 Equal Opportunity Employer

ACCOUNTING CLERK This opening at our Product Development Center in Troy represents an excellent opportunity to demonstrate your accounting skills in a professional environment as an Accounting Clerk with at least one year of business experience and a basic understanding of accounting principles. Completion of college level courses in accounting is a plus. Accurate typing skills of 30 wpm are necessary. We offer a competitive salary and benefit package. For confidential consideration please submit resume indicating salary history to: BOX 862 Equal Opportunity Employer

ACCOUNTING CLERK This opening at our Product Development Center in Troy represents an excellent opportunity to demonstrate your accounting skills in a professional environment as an Accounting Clerk with at least one year of business experience and a basic understanding of accounting principles. Completion of college level courses in accounting is a plus. Accurate typing skills of 30 wpm are necessary. We offer a competitive salary and benefit package. For confidential consideration please submit resume indicating salary history to: BOX 862 Equal Opportunity Employer

ACCOUNTING CLERK This opening at our Product Development Center in Troy represents an excellent opportunity to demonstrate your accounting skills in a professional environment as an Accounting Clerk with at least one year of business experience and a basic understanding of accounting principles. Completion of college level courses in accounting is a plus. Accurate typing skills of 30 wpm are necessary. We offer a competitive salary and benefit package. For confidential consideration please submit resume indicating salary history to: BOX 862 Equal Opportunity Employer

ACCOUNTING CLERK This opening at our Product Development Center in Troy represents an excellent opportunity to demonstrate your accounting skills in a professional environment as an Accounting Clerk with at least one year of business experience and a basic understanding of accounting principles. Completion of college level courses in accounting is a plus. Accurate typing skills of 30 wpm are necessary. We offer a competitive salary and benefit package. For confidential consideration please submit resume indicating salary history to: BOX 862 Equal Opportunity Employer

ACCOUNTING CLERK This opening at our Product Development Center in Troy represents an excellent opportunity to demonstrate your accounting skills in a professional environment as an Accounting Clerk with at least one year of business experience and a basic understanding of accounting principles. Completion of college level courses in accounting is a plus. Accurate typing skills of 30 wpm are necessary. We offer a competitive salary and benefit package. For confidential consideration please submit resume indicating salary history to: BOX 862 Equal Opportunity Employer

ACCOUNTING CLERK This opening at our Product Development Center in Troy represents an excellent opportunity to demonstrate your accounting skills in a professional environment as an Accounting Clerk with at least one year of business experience and a basic understanding of accounting principles. Completion of college level courses in accounting is a plus. Accurate typing skills of 30 wpm are necessary. We offer a competitive salary and benefit package. For confidential consideration please submit resume indicating salary history to: BOX 862 Equal Opportunity Employer

ACCOUNTING CLERK This opening at our Product Development Center in Troy represents an excellent opportunity to demonstrate your accounting skills in a professional environment as an Accounting Clerk with at least one year of business experience and a basic understanding of accounting principles. Completion of college level courses in accounting is a plus. Accurate typing skills of 30 wpm are necessary. We offer a competitive salary and benefit package. For confidential consideration please submit resume indicating salary history to: BOX 862 Equal Opportunity Employer

ACCOUNTING CLERK This opening at our Product Development Center in Troy represents an excellent opportunity to demonstrate your accounting skills in a professional environment as an Accounting Clerk with at least one year of business experience and a basic understanding of accounting principles. Completion of college level courses in accounting is a plus. Accurate typing skills of 30 wpm are necessary. We offer a competitive salary and benefit package. For confidential consideration please submit resume indicating salary history to: BOX 862 Equal Opportunity Employer

ACCOUNTING CLERK This opening at our Product Development Center in Troy represents an excellent opportunity to demonstrate your accounting skills in a professional environment as an Accounting Clerk with at least one year of business experience and a basic understanding of accounting principles. Completion of college level courses in accounting is a plus. Accurate typing skills of 30 wpm are necessary. We offer a competitive salary and benefit package. For confidential consideration please submit resume indicating salary history to: BOX 862 Equal Opportunity Employer

ACCOUNTING CLERK This opening at our Product Development Center in Troy represents an excellent opportunity to demonstrate your accounting skills in a professional environment as an Accounting Clerk with at

504 Help Wanted Office-Clerical LIVING EXEC. SECT'Y... DOROTHY DAY PERSONNEL, INC.

504 Help Wanted Office-Clerical PERSON ON for office... PERSONNEL COORDINATOR

504 Help Wanted Office-Clerical RECEPTIONIST Part time, non-smoker... RECEPTIONIST/SECRETARY

504 Help Wanted Office-Clerical SECRETARIAL POSITION in property management office... SECRETARIES Word Processing Operators Typists Data Entry Operators

504 Help Wanted Office-Clerical SECRETARY light office duties... SECRETARY Major trade association based in Southfield

504 Help Wanted Office-Clerical SECRETARY wanted for Canton office... SECRETARY TROY SECRETARY \$14,000 FEE PAID

504 Help Wanted Office-Clerical THIRD PARTY MEDICAL biller... TROY SECRETARY \$14,000 FEE PAID

504 Help Wanted Office-Clerical \$\$\$\$ Abilities Rewarded Typists Word Processors Secretaries Data Entry

505 Help Wanted Food-Beverage COOKS, PREP COOKS... COOKS, WAIT PERSONS

NICE JOB/NICE PEOPLE RECEPTIONIST/ SWITCHBOARD \$10,400-\$11,440 FEE PAID

RECEPTIONIST TROY AREA Full time position for a prominent real estate firm

Receptionist/ Bookkeeper Light typing, filing. We will train. Hospitalization and salary. Livonia area. Please call for appointment

Work at a Fortune 500 company in the Troy area. We have immediate long and short term assignments for individuals with the skills listed above

SECRETARY needed for Southfield office. Part time to start. Wages & benefits depending on experience

SECRETARY needed for manufacturer's rep agency. Typing, customer service, sales, and general office work

SECRETARY needed for modern down town Birmingham law office. Legal experience helpful but not necessary

Build your resume and add \$\$\$ to your bank account. Work where and when you want and enjoy your summer too. Call S.S.I. today.

COOKS, WAIT PERSONS... COOKS, WAIT PERSONS... COOKS, WAIT PERSONS

OFFICE ASSISTANT Full-time Summer job. Data entry & clerical duties. No experience necessary

RECEPTIONIST/SECRETARY Part Time. Hours: Noon-5pm. Part time a good typist. Will train as Tel-Ex operator

Receptionist Immediate opening for highly motivated person with good telephone skills

SECRETARY Part time/afternoon previous experience helpful, but not necessary

SECRETARY Prominent local national club requires experienced typist, computer bookkeeping and filing

SECRETARY Real Estate Office in Farmington Hills. Responsibilities include typing, filing, reports and misc. Call 474-3303

SECRETARY Part time. Hours: Noon-5pm. Part time a good typist. Will train as Tel-Ex operator

505 Help Wanted Food-Beverage ACCEPTING APPLICATIONS for Bar Person, Wait Staff & Bus Help

DINING ROOM SUPERVISOR Full time position working in senior citizen dining room

OFFICE CLERICAL Clerks full & part time for Livonia area. R. Leads Furniture, Call between 10am-4pm

RECEPTIONIST/SECRETARY Part Time. Hours: Noon-5pm. Part time a good typist. Will train as Tel-Ex operator

Receptionist/ Typist You will enjoy top pay, merit increase and vacation pay

SECRETARY Part time/afternoon previous experience helpful, but not necessary

SECRETARY Real Estate Office in Farmington Hills. Responsibilities include typing, filing, reports and misc. Call 474-3303

SECRETARY Part time/afternoon previous experience helpful, but not necessary

WE HAVE TWO OPENINGS FOR TOP TYPISTS The Troy office of the Hartford Insurance Group has openings in Claims and Policy Insurance departments

505 Help Wanted Food-Beverage ACCEPTING APPLICATIONS for Bar Person, Wait Staff & Bus Help

DINING ROOM SUPERVISOR Full time position working in senior citizen dining room

OFFICE CLERICAL Clerks full & part time for Livonia area. R. Leads Furniture, Call between 10am-4pm

RECEPTIONIST/SECRETARY Part Time. Hours: Noon-5pm. Part time a good typist. Will train as Tel-Ex operator

Receptionist/ Typist You will enjoy top pay, merit increase and vacation pay

SECRETARY Part time/afternoon previous experience helpful, but not necessary

SECRETARY Real Estate Office in Farmington Hills. Responsibilities include typing, filing, reports and misc. Call 474-3303

SECRETARY Part time/afternoon previous experience helpful, but not necessary

WE HAVE TWO OPENINGS FOR TOP TYPISTS The Troy office of the Hartford Insurance Group has openings in Claims and Policy Insurance departments

505 Help Wanted Food-Beverage ACCEPTING APPLICATIONS for Bar Person, Wait Staff & Bus Help

DINING ROOM SUPERVISOR Full time position working in senior citizen dining room

"We take the food service business more seriously than anyone" Ray Kroc McDonald's Corporation. For McDonald's founder... At McDonald's, this approach is still very much in effect...

RECEPTIONIST/SECRETARY Part Time. Hours: Noon-5pm. Part time a good typist. Will train as Tel-Ex operator

SECRETARY Part time/afternoon previous experience helpful, but not necessary

WE HAVE TWO OPENINGS FOR TOP TYPISTS The Troy office of the Hartford Insurance Group has openings in Claims and Policy Insurance departments

505 Help Wanted Food-Beverage ACCEPTING APPLICATIONS for Bar Person, Wait Staff & Bus Help