

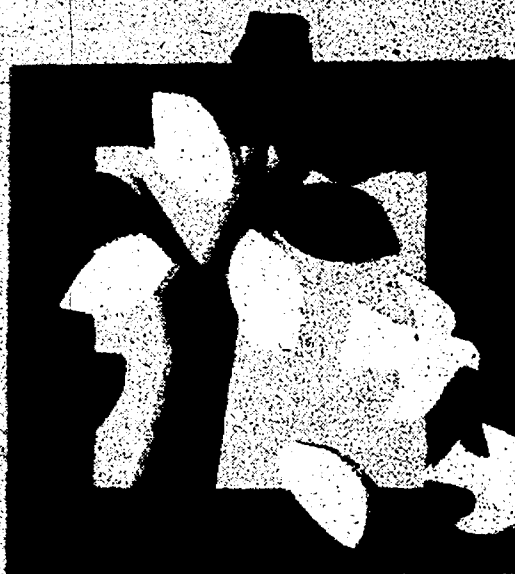

# The Community Crier

The Newspaper with Its Heart in The Plymouth-Canton, MI Community

*Come Home for the Holidays*

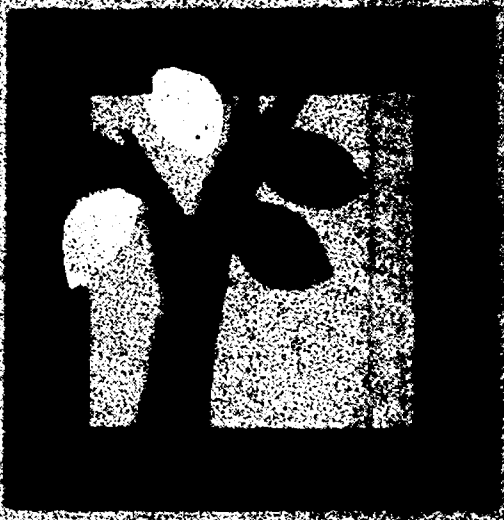
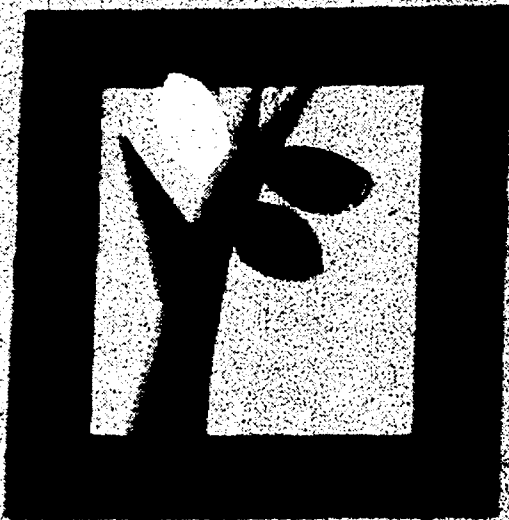
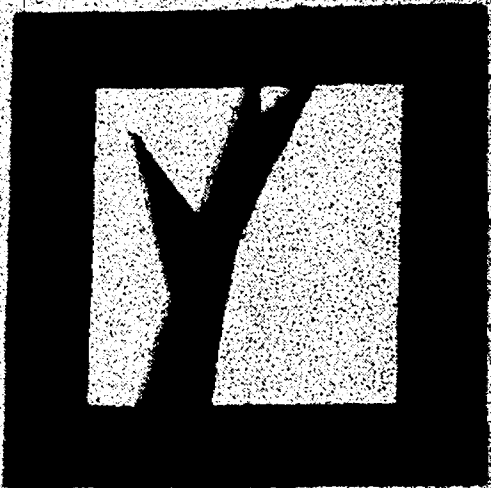

# our very best sale

## 3 DAYS ONLY

**FOR 3 DAYS ONLY  
PURCHASE SUPERB QUALITY  
FURNISHING AT A  
SUBSTANTIAL SAVINGS. JUST  
IN TIME FOR THE HOLIDAYS!**

When it comes to relaxation, styling excellence and a beautiful addition to any home, we have one word for it. Stressless. The Golf chair and ottoman in rich burgundy leather with black base. \$739.

No matter what your type, the Jesper printer stand is a perfect match.

A companion to the Jesper 224C computer stand. Teak finish and rolling castors. Reg. \$195 Sale \$119.

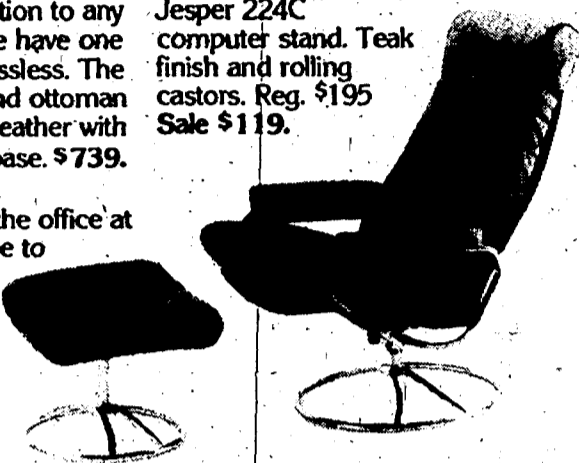

MINI GRANDPRIX

Great for the student, the office at home or simply a place to organize. This desk and return by Jesper is available in all white or teak finish. 30" x 64", one file and two drawers. Only \$449 Special Sale Price.

When it comes to relaxation, styling excellence and a beautiful addition to any home, we have one word for it. Stressless. The Golf chair and ottoman in rich burgundy leather with black base. \$739.

From TV viewing to reading the Sunday Times, the Stressless Mini-Grand Prix adds a new dimension to comfort. Chair and ottoman available in Coffee and Natural Leather. \$549.

Sleep like a queen on this queen sleeper by Rowe. Featuring a Serta Inner Spring Mattress. 2 pc. Queen Sectional Sleeper with TV headrest \$1499.

Update both your hardware and software with the Jesper computer cart. 24" x 48", finished on all sides and rolling castors. Teak finish. Reg. \$259 Sale \$149.

Add the richness of color to your room with a light and lively occasional chair. Beechwood frame. Available in natural canvas, apple green or peach. \$239.

Rich Italian leather has never been so striking! The Independence Series by Italia Design offers a sofa, love seat and chair or 5 seat sectional in clay or bone. Sofa \$949, Love seat \$889, Chair \$779, 5 seat sectional \$2099 (2 seat left arm, 2 seat right arm and wedge)



INDEPENDENCE

You'll be the next teen hero in your home with the Jesper Teen Bedroom Set. Available in White Melamine/Beech or all Teak, featuring a bookcase headboard and trundle for extra storage. Reg. \$734 Sale \$449.

A dual purpose cart by Jesper can serve up a TV dinner or the latest network mini-series. Available in teak or natural oak, great viewing no matter how you use it! Reg. \$339 Sale \$209.

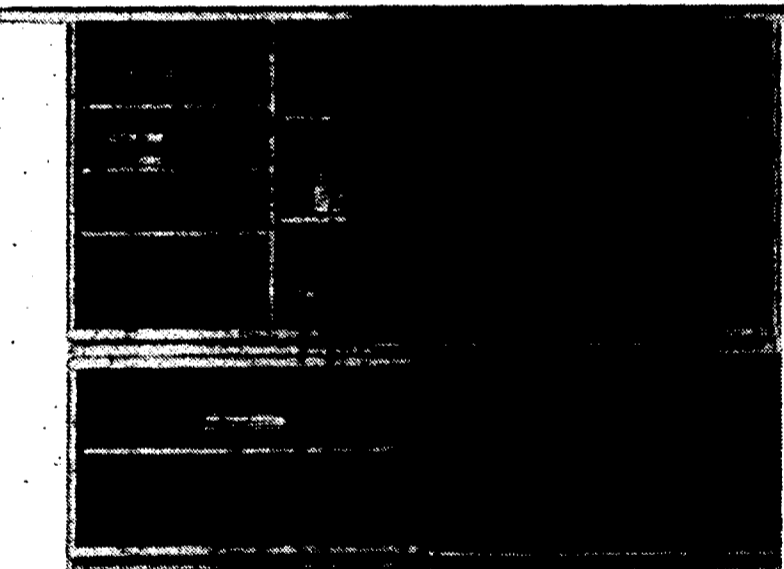

EVITA

A trio of entertainment: The Evita Wall Unit 87w x 65h x 22-1/2d, Milk Ash Reg. \$1939 Sale \$1349. Teak Reg. \$2175 Sale \$1449. Pasadena 82w x 56h x 22-1/2d Teak Reg. \$2775 Sale \$1849. Amadaeus, lacquer in black and champagne 64w x 55-1/2h x 24d Reg. \$1915 Sale \$1399. All three feature a sliding door TV center.

Vanity stools perfect for the hallway, bath or bedroom. These 4 foot vanity stools feature a teak frame and oatmeal fabric. \$259.

The dramatic look of leather in Black or Grey. The Velda Sofa, Love seat and Chair. All three pieces, \$1995. Apartment size, group sale only.

## Schools receive deferral

BY DAN JARVIS

The Plymouth-Canton Community Schools have applied for and received an asbestos management plan deferral from Oct. 12, 1988 until May 9, 1989, said Dan Menghini, director of operations and maintenance for the district.

Across the state, said Menghini, testing laboratories were flooded with sample orders and were unable to meet the Oct. 12 deadline.

In anticipation of the problem, said Menghini, the state Department of Public Health offered the deferral option to give the district a chance to meet the deadline.

"We were ready with everything," said Menghini, "the inspections, the plan, and the samples. We just couldn't get any lab in Michigan or out of state to get the results back in time."

### HOME ST.

New address?  
**WELCOME WAGON**  
can help you  
feel at home

Greeting new neighbors is a tradition with WELCOME WAGON — "America's Neighborhood tradition."

I'd like to visit you. To say "Hi" and present gifts and greetings from community-minded business. I'll also present invitations you can redeem for more gifts. And it's all free.

A WELCOME WAGON visit is a special treat to help you get started and feeling more "at home." A friendly get-together is easy to arrange. Just call me.

*Welcome Wagon*

Call Myra  
459-9754

(Plymouth Area)

## The Community Crier

USPS-340-150 Published weekly at 821 Penniman Ave., Plymouth, MI 48170. Carrier delivered: \$14 per year. Mail delivered: \$20 per year. Mailed 2nd class circulation rates, postage paid at Plymouth, MI 48170. Call (313) 453-6900 for delivery.



The Crier's advertisers strive to honestly present commercial messages to our readers. If, for any reason, you find problems with a Crier ad, please call our office at 453-6900.

Crier advertising is published in accordance with those policies spelled out on the current rate card, which is available during business hours from our office at 821 Penniman Ave., Plymouth. The publisher, solely, makes final acceptance of a specific advertisement (not an advertising representative) and only publication of the ad signifies such acceptance.

Postmaster, send change of address notice to The Community Crier, 821 Penniman Ave., Plymouth, MI 48170.

# house of denmark



Keego Harbor 3325 Orchard Lake Rd. (1 Mile North of Long Lake Rd.) 682-7600  
Livonia 3555 Plymouth Rd. (1 1/2 Miles West of Farmington Rd.) 425-4040  
Rochester 893 South Rochester Rd. (2 Miles North of M-59) 651-9430

Tues., Wed., Sat. 10-5:30 / Thurs., Fri. 10-9 / Sun 12-5 (Closed Mondays) Most major credit cards accepted.

# Court authority planned by council

**EDITOR'S NOTE** — *The Crier* begins a series on the 35th District Court this week with a story on the recently revealed authority plan. In the coming weeks, *The Crier* will look at various aspects of the court system.

BY KEN VOYLES,  
PAUL GARGARO, AND  
DAN JARVIS

Representatives of the 35th District Court Advisory Council met last week to move ahead with the formation of an authority to own and operate the court facility located on Plymouth Road in the City of Plymouth.



The communities which use the 35th District Court and form the advisory council include: Plymouth, Plymouth Township, Canton, Northville, and Northville Township.

The meeting produced a document calling for an "interlocal" agreement to establish an authority to "implement, on a continuing basis," the leasing, ownership, use, operation, financing and possible replacement of the courthouse.

The plan is currently being circulated among community representatives and attorneys for each community are in the process of studying the wording of the agreement.

Community representatives will try and seek approval from their respective governing bodies by the end of this year. The court's fiscal year is the same as the calendar year.

"We're looking for a legal identity, one which will take over when the

bonds are paid off," said Plymouth City Manager Henry Graper, a member of the 35th Advisory Council, who called the move a "housekeeping" step. "I think it's an excellent document," he said.

The authority would become the legal and administrative control body over the court, or a "public body, corporate," according to 35th District Court Judge James Garber. It would acquire the lease of the property and continue its operation for the "mutual use and benefit" of the five communities.

"The authority would have a board of directors and resemble the advisory board," said Garber. "It's nothing more than completing the cycle we started eight years ago. I can't foresee why we wouldn't want to do this."

Garber added that the bonds for the courthouse, issued by Plymouth, are nearly one-third paid off and that it is time to get the authority formed to satisfy bondholders about the future of the building.

The authority would also become the contractor for maintenance and other court operations, something Plymouth has done since the court was built in 1981.

Gerald Brown, Canton's council representative, said the city (Plymouth) doesn't need to be in a "middleman" role with the maintenance contractors.

Garber agreed saying, "The city has acted as middleman and that's not the way it should be.

"We at the court want to make sure we're paying for everything," he added.

The document calls for any shortfall in operating costs to be absorbed by contributions from the five communities. Projections are that the court will generate approximately \$2 million for 1988, said Garber, and that expenditures would be about \$1.2 million.

The document also stresses that the authority shall have "no power or authority to levy any type of tax within the boundaries of any of the parties."

It will also not be able to issue bonds.

"This is a good idea, although it's not so much the result of problems with the court," said Steven Walters, council member and city manager of Northville. "It could have been done when the court was completed but at the time the feeling was that it wasn't much of an issue."

Walters said the court has shared expenses since the facility was built. When a single court was first discussed there were courts in Plymouth, Northville and Canton. "At the time it seemed to be practical to make a general agreement of the group," Walters said. "If I was the City of Plymouth, I'd prefer to have this formalized."

Walters said Plymouth had been doing the other four communities a "service" by carrying the debt and



## Hoben honored

John M. Hoben (center, background) bows his head during Sunday's benediction for the new Hoben Elementary School. The school was dedicated on Sunday. With Hoben are some of the students who currently attend the new school. (Crier photo by Chris Farina)

## Sheriff seeks Twp. help in keeping prison afloat

BY PAUL GARGARO

Does Wayne County Sheriff Robert Ficano need help running the Wayne County Prison?

He doesn't think so and apparently neither does the Plymouth Township Board of Trustees, which voted on Tuesday to look at ways to oppose the placement of the county jail under receivership.

A receivership would assume the responsibility of running the county jail for the county.

Invited to speak before the board, Ficano gave background into the issue, which resulted from a 1971 court case in which the prison inmates fought for better conditions.

Among those original grievances were complaints of faulty plumbing,

overcrowding, frequent cases of assault, inadequate heating, and a high instance of suicide.

Ficano said those problems have been addressed.

"Today, conditions are like night and day," said Ficano. "Since 1971, we've been under court order, but that order has been changing. There's a whole new interpretation of what quality of (prison) life is supposed to be like."

Ficano said that the jail facilities currently house nine recreation facilities, ping pong tables, pool tables and video games. In addition, the sheriff said the inmates get medical and dental care within 24 hours of their arrival and that prison suicides, which used to average "seven or eight a year" are now down to three in the last three years.

"In Wayne County things have gotten better," said Ficano. "Receivers are usually brought in when a situation has deteriorated, but this is just the opposite."

Please see pg. 9

## Supervisor post to be full time?

BY KEN VOYLES

Last night, Canton's new ruling board of trustees — including neophytes Tom Yack, Robert Shefferly and Henry Whalen — was expected to return the supervisor's job to full-time and increase the salary accordingly.

Back in April this year the board, including outgoing members Linda Chuhnan, Robert Padget and James Poole, voted to reduce the job to part-time and cut the salary to \$18,000 beginning on Sunday (Nov. 20). Poole was against the move.

Voters in Canton defeated a superintendent ballot during the August primary that would have made it possible for the township to hire a

Please see pg. 44

**PIZZA:** Some young students got a chance to learn about the process of making a pizza last week. See pg. 10

**HOLIDAYS:** The Crier's "Come Home for the Holidays" Plus Section begins on pg. 15

Please see pg. 14



# Public notices

## CHARTER TOWNSHIP OF CANTON BOARD PROCEEDINGS MINUTES OF NOVEMBER 15, 1988 (PROPOSED)

A special meeting of the Township Board of the Charter Township of Canton was held at 1150 South Canton Center Road on Tuesday, November 15, 1988.

Supervisor Poole called the meeting to order at 7:00 p.m., and led the Pledge of Allegiance to the Flag.

### ROLL CALL:

Members Present: Bennett, Brown, Chuhuran, Kirchgatter, Padget, Poole and Prenczky.

### STAFF PRESENT:

Dingeldey, Durack, Gouin, Nicholson, Santomauro and Spencer

### APPROVAL OF MINUTES OF NOVEMBER 1, 1988:

Motion by Kirchgatter, supported by Bennett, to approve the Minutes of November 1, 1988, as printed.

Ayes: Bennett, Brown, Chuhuran, Kirchgatter, Padget and Prenczky

Abstain: Poole

### PAYMENT OF BILLS:

Motion by Brown, supported by Padget, to approve the Bills as received.

Ayes: Padget, Prenczky, Bennett, Brown, Chuhuran and Kirchgatter

Nays: Poole.

### EXPENDITURE RECAP:

GENERAL FUND (101)	\$371,592.77
FIRE FUND (206)	57,076.80
POLICE FUND (207)	79,067.62
GOLF COURSE (211)	59,716.49
WATER AND SEWER (592)	439,472.68
TRUST AND AGENCY (701)	6,360.00
STREET LIGHTING (861)	12,080.21
AUTO THEFT GRANT (267)	15,157.26
WESTLAND STATE (289)	819.94

Details are available at the Office of the Clerk.

### ACCEPTANCE OF AGENDA:

Item No. 15, RESOLUTION OF WESTERLY 100 FEET EASEMENT, PARCEL NUMBER 106-99-0001-003, was added.

Item No. 1, PURCHASE OF PATROL CARS — PURCHASE OF RADIO FOR PUBLIC SAFETY VEHICLE, was deleted.

Item No. 3 PURCHASE OF TANDY PC8 PROGRAMMABLE CALCULATORS, was deleted.

Item No. 4, PROPOSED AMENDMENT TO ORDINANCE 106 — ANIMAL CONTROL, was deleted.

Item No. 5, BUDGET AMENDMENT, was deleted.

Item No. 8, PAYMENT WALSH — CHERRY HILL SCHOOL \$3,000.00, was deleted.

Item No. 10, AWARD BID SHELDON CENTER TREE PLANTING, was deleted.

Item No. 11, FINAL ACCEPTANCE WATER MAINS AND SANITARY LATERAL, was deleted.

Item No. 12, STORM RESOLUTION — CHERRY HILL-CANTON PROFESSIONAL PARK, CHERRY HILL ROAD, was deleted.

Item No. 13, PURCHASE OF TYPEWRITER TABLE, was deleted.

Item No. 14, PURCHASE OF COMPUTER STAND AND SHELVING, was deleted.

Motion by Chuhuran, supported by Kirchgatter, to approve the Agenda as amended.

Ayes: Chuhuran, Kirchgatter, Padget, Poole, Prenczky and Bennett

Nays: Brown

### CORRESPONDENCE:

Supervisor Poole commented on the magnificent new Canton Library. He stated that some residents did not remove their hats during the Pledge of Allegiance to the Flag at the dedication ceremony.

Clerk Chuhuran summarized the election process. One booth device was provided for every 200 voters in each precinct, which was more than the state requirement. Clerk Chuhuran commended the 250 election workers. Some employees worked a 24-hour shift. It was unfortunate that some members of the public were throwing paper at an election worker. There were voters who did not check their precinct, and stood in the line at the wrong precinct. Some voters did not brief themselves on the sample ballot in the Clerk's Office and in the newspaper, therefore, taking 15 minutes to select their candidates in the voting booth.

### DEPARTMENT REPORTS:

Treasurer Brown reported, as the Canton representative on the 35th District Court Advisory Council, that a meeting of the Council and the two judges was held on November 14.

A major item of the meeting was to establish a 35th District Court Building Authority. The primary purpose of the Authority, a separate legal entity, was to assume the responsibility for the maintenance and for bond payments of the Court Building.

The establishment of the Authority will require a favorable vote of each of the five communities' Boards. Treasurer Brown stated that the proposed plan has been turned over to J. Hemming, the Township attorney, for review, before his presenting it to the Canton Board for approval.

Supervisor Poole expressed concern over a request of payment for the property from the five communities by the City of Plymouth. Mr. Brown stated that Plymouth's request had been withdrawn, and was no longer a problem.

### CITIZENS FORUM:

Mr. Fred Somes of Wolverine Telecom, Inc. (WolTel) discussed the recent bids from his company and from Michigan Bell Communications, Inc. for telephone equipment.

### GENERAL CALENDAR:

#### Item No. 2 ATTORNEY'S OPINION REGARDING TOWNSHIP PENSION PLAN

Discussion followed whether a part-time supervisor can be excluded from the Township's Pension Plan as previously decided in a motion given on April 5, 1988, by the current Board.

Mr. Fiedler, the Township Attorney, recommended in his correspondence dated November 11 that the Township Pension Plan be reviewed and redrafted in detail and then submitted to the IRS for review.

It was agreed by Mr. Durack and the current Board that the future Board may rectify the Board's motion of April, if necessary.

Motion by Padget, supported by Kirchgatter, that the Township Board refer the issue of the Pension Plan to Mr. Durack, and that his office initiate the Township Pension Plan review as recommended by the Township Attorney. Motion carried unanimously.

#### Item No. 6 SRL REZONING, LOCATED ON THE EAST SIDE OF BECK ROAD BETWEEN WARREN AND JOY ROADS.

Supervisor Poole stated that he received a call from the attorney representing the SRL Rezoning, notifying the Board that he could not be present tonight.

Motion by Chuhuran, supported by Brown, to deny the 32-acre SRL rezoning request from R-2 to R-3.

Motion by Kirchgatter, supported by Bennett, to table the SRL rezoning request.

Roll Call on the tabling motion:

Ayes: Bennett, Chuhuran and Kirchgatter

Nays: Brown, Padget, Poole and Prenczky

Motion to table failed 4-3.

Discussion followed regarding notification to the petitioner.

Motion by Chuhuran, supported by Kirchgatter, to table.

Roll Call on the tabling motion:

Ayes: Chuhuran, Kirchgatter

Nays: Brown, Padget, Poole, Prenczky and Bennett

Motion Failed.

Discussion followed regarding the fact that all concerned parties were not present to discuss the rezoning request.

Trustee Prenczky called the question.

Motion by Bennett, supported by Chuhuran, to table the rezoning request.

Ayes: Chuhuran, Kirchgatter, Poole, Bennett and Brown

Nays: Padget and Prenczky

Motion to table passed 5-2.

Mr. John Goulet, 7990 Beck Road, and Mr. Jim McCullen, representing Colony Swim Club, stated that since they had received notification that the SRL rezoning would be on tonight's agenda, they expected the Board to make a decision tonight.

#### Item No. 7 M.L.C. CORPORATION — RELEASE TO APPLY FOR INDUSTRIAL FACILITY EXEMPTION CERTIFICATE

Motion by Padget, supported by Chuhuran, to adopt the Resolution consenting to a transfer of employment in connection with the relocation of M.L.C. Corporation operations from the Charter Township of Canton, Michigan to the Charter Township of Plymouth, Michigan, as required pursuant to Public Act 198 of 1974, as amended.

Ayes: Padget, Poole, Bennett, Brown and Chuhuran

Nays: Kirchgatter and Prenczky

#### Item No. 9 PAYNE PAVING

Discussion followed regarding a variance to the requirement for paving of the sales area of the Wonderland Mobile Home Sales site, 45475 Michigan Avenue, and a special three year use permit approved by the ZBA on April 27, 1978.

According to an additional motion issued on May 21, 1981, by the ZBA, the petitioner was required to bring the site into compliance with the approved site plan by November 30, 1981, and any expansion must comply to the ordinance relative to site plan approval.

#### Item No. 15 RESOLUTION — WESTERLY 100 FOOT EASEMENT — RIVERPARK SUBDIVISION

Motion by Brown, supported by Kirchgatter, regarding the property, which Canton Township is selling to the Plymouth-Canton School District, Parcel Number 106-99-0001-003 on the corner of Sheldon and Palmer Roads, that the westerly 100 feet be retained for Canton Township ownership, and be excluded in the sale to the Schools. Motion carried unanimously.

Motion by Chuhuran, supported by Kirchgatter, to adjourn at 8:25 p.m. Motion carried unanimously.

Linda Chuhuran  
Administrative Township Clerk

## CHARTER TOWNSHIP OF CANTON PLANNING COMMISSION NOTICE OF PUBLIC HEARING

The Planning Commission will consider the terms of a proposed Consent Judgment Agreement and an amendment to the Pickwick Village Planned Unit Development Agreement to permit the development of a single family attached condominium on the lands identified in property tax records as parcels 041-99-0021-000 and 041-99-0022-001. The legal description for the land is as follows:

### DESCRIPTION

A PARCEL OF LAND IN THE N.E. 1/4 OF SECTION 11 T. 2 S., R. 8 E., CANTON TOWNSHIP, WAYNE COUNTY, MICHIGAN DESCRIBED AS: BEGINNING AT A POINT ON THE N. & S. 1/4 LINE OF SAID SECTION 11 S. 00°01'43"E. 660.55 FEET FROM THE N. 1/4 CORNER OF SAID SECTION 11; THENCE FROM SAID POINT OF BEGINNING N.88°50'02"E. 1308.84 FEET; THENCE S.00°00'59"E. 550.83 FEET; THENCE THE FOLLOWING FIVE COURSES ALONG THE NORTH LINE OF "PICKWICK VILLAGE" AS RECORDED IN LIBER 94, PAGE 62, WAYNE COUNTY RECORDS, S.88°50'02"W. 649.18 FEET MEASURES (649.40 FEET REC.) AND S.40°57'51"W. 260.97 FEET AND S.89°58'17"W. 300.00 FEET AND N.78°22'14"W. 64.33 FEET AND S. 89°58'17"W. 125.22 FEET; THENCE N. 00°01'43"W. 721.71 FEET ALONG THE SAID N. & S. 1/4 LINE SECTION 11 TO THE POINT OF BEGINNING AND CONTAINING 18.996 ACRES MORE OR LESS.

The hearing will be held during the Planning Commission meeting of December 19, 1988, which begins at 7:30 p.m. Eastern Standard Time at the Township Administration Building located at 1150 South Canton Center Road, Canton, Michigan.

This notice is provided pursuant to the requirements of Act 184 of the Public Acts of 1943 of the State of Michigan, as amended, and pursuant to the Zoning Ordinance of the Charter Township of Canton.

Richard Kirchgatter, Chairman  
Planning Commission

Publish: November 23, 1988  
December 14, 1988

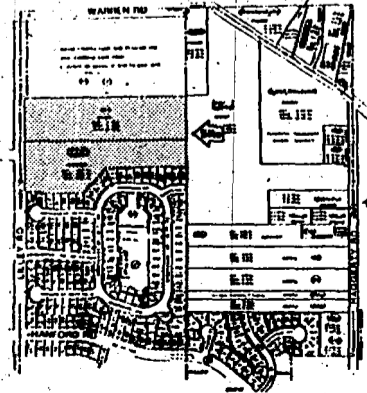

# Daskalakis: Schools ignore moral responsibilities

BY DAN JARVIS

While the Plymouth-Canton Community Schools Board of Education awaits the recommendation on the use of R-rated materials in classrooms from district Superintendent John M. Hoben, a newsletter blasting the school's policy on the subject is being distributed to residents by the Citizens for Better Education (CBE).

The purpose of the newsletter, as stated in the publication's introduction, written by CBE president Diane Daskalakis, is "to alert the Plymouth-Canton residents that many of our children are being introduced to extremely dangerous and objectionable materials through our school's classrooms."

In the newsletter, the Plymouth-Canton schools are charged by CBE with "promoting sexual immorality to our youth," and "directing our youth

to seek extremely important counseling and even abortions outside the family's knowledge or consent."

Michael Homes, assistant superintendent for instruction for the district, said, "If the CBE is saying that the district is immoral or amoral, I would have to categorically reject that."

"I think that anyone who is educated would have to reject that also," he added.

On the subject of abortions, the newsletter states that since referrals to abortions clinics are made with the help of school health books, the schools should bear the responsibility of unexpected complications resulting from an abortion if obtained through an organization mentioned in a school library book.

The following paragraph appears in the CBE publication: "If complications occur, it would be inappropriate to hold parents financially

responsible when the schools and the organization they referred took such measures to keep it a secret from the parents."

CBE also charges the school district with ignoring moral responsibilities.

"They (students) spend the majority of each day, five days a week, in an educational system that doesn't care enough about them to provide a proper sense of morality," noted the newsletter.

Homes said the district has consistently followed the guidelines set forth in Public Act 226 passed by the Michigan Legislature.

"The act speaks to the subject of family planning and does not recognize abortion as a legitimate means of the family planning or birth control," said Homes.

The school administrator added that with many of the materials being questioned by CBE, the district has

sent letters home informing parents when a particular movie will be shown and why the lessons may be important.

"Some parents have complained," said Homes, "But most of the complaints have come from Diane (Daskalakis) and CBE."

In a list of CBE goals, the organization states they are committed to electing a new school board.

"We have no other alternative than to diligently attempt to elect others who will represent our viewpoint," Daskalakis wrote in the newsletter. "Last June we (CBE) supported Barbara Graham's candidacy for school board and are thankful she is now serving on the board."

Daskalakis said CBE will oppose any attempts by the school district to pass additional millages until some concessions can be reached.

"If they (the school board) attempt

Please see pg. 49

## Public notices

**CANTON TOWNSHIP PLANNING COMMISSION  
CHARTER TOWNSHIP OF CANTON  
NOTICE OF PUBLIC HEARING**

A PROPOSED AMENDMENT TO THE ZONING ORDINANCE OF THE CHARTER TOWNSHIP OF CANTON, WAYNE COUNTY, MICHIGAN.

THE REQUEST BEING TO REZONE PARCEL 71 022 99 0009 000 FROM AGR, AGRICULTURAL RESIDENTIAL TO R-1, SINGLE FAMILY RESIDENTIAL. PROPERTY IS LOCATED ON THE EAST SIDE OF NAPIER ROAD BETWEEN ANN ARBOR ROAD AND WARREN ROAD.

The hearing will be held during the Planning Commission meeting of December 19, 1988, which begins at 7:30 p.m. Eastern Standard Time at the Township Administration Building located at 1150 South Canton Center Road, Canton, Michigan.

This notice is provided pursuant to the requirements of Act 184 of the Public Acts of 1943 of the State of Michigan, as amended, and pursuant to the Zoning Ordinance of the Charter Township of Canton.

Richard Kirchgatter, Chairman  
Planning Commission

Publish: November 23, 1988  
December 14, 1988

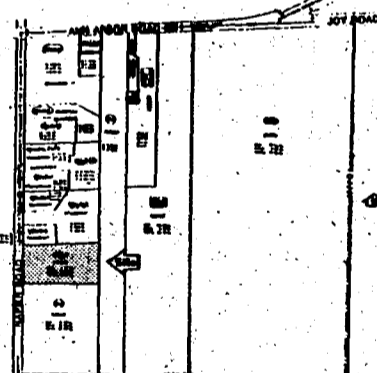

**CANTON TOWNSHIP PLANNING COMMISSION  
CHARTER TOWNSHIP OF CANTON  
NOTICE OF PUBLIC HEARING**

PROPOSED AMENDMENT TO THE ZONING ORDINANCE OF THE CHARTER TOWNSHIP OF CANTON, WAYNE COUNTY, MICHIGAN

NOTICE IS HEREBY GIVEN pursuant to Act 184 of the Public Acts of 1943 of the State of Michigan, as amended, and pursuant to the Zoning Ordinance of the Charter Township of Canton that the Planning Commission of the Charter Township of Canton will hold a Public Hearing on Monday, December 19, 1988, at the Canton Township Administration Building, 1150 South Canton Center Road at 7:30 p.m. on the following proposed amendments to the Zoning Ordinance.

CONSIDER REQUEST TO REZONE PARCELS 125-99-0002-000 AND 128-99-0004-000 LOCATED ON THE NORTH SIDE OF MICHIGAN AVENUE BETWEEN BECK ROAD AND DENTON ROAD FROM AGI, AGRICULTURAL INDUSTRIAL TO LI-2, LIGHT INDUSTRIAL.

Richard Kirchgatter, Chairman  
Planning Commission

Publish: November 23, 1988  
December 14, 1988

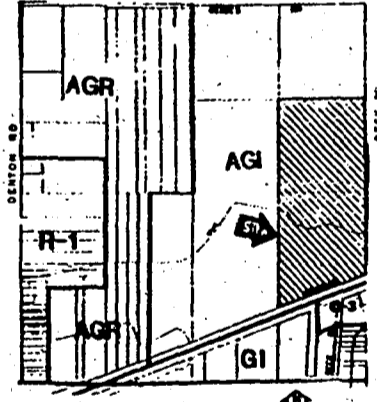

**CANTON TOWNSHIP PLANNING COMMISSION  
CHARTER TOWNSHIP OF CANTON  
NOTICE OF PUBLIC HEARING**

A PROPOSED AMENDMENT TO THE ZONING ORDINANCE OF THE CHARTER TOWNSHIP OF CANTON, WAYNE COUNTY, MICHIGAN

Article 3.00  
Section 3.01: Definitions

Add Wholesale Auto Auction Facility: A land use intended for the sale and distribution of used automobiles by a single business entity specifically to licensed wholesale automobile dealers by auction. This land use may include accessory uses such as repair, refurbishing and vehicle wash facilities for the subject automobiles on the premises.

Article 22.00  
Section 22.03: Uses Permitted by Special Approval

Add F. Wholesale Auto Auction Facility. See Section 26.01 BB.

Article 26.00  
Article 26.01: Site Development Requirements

The referenced Articles may be modified and additional Articles may be amended as required.

The hearing will be held during the Planning Commission meeting of December 19, 1988, which begins at 7:30 p.m. Eastern Standard Time at the Township Administration Building, 1150 South Canton Center Road, Canton, Michigan.

This notice is provided pursuant to the requirements of Act 184 of the Public Acts of 1943 of the State of Michigan, as amended, and pursuant to the Zoning Ordinance of the Charter Township of Canton.

Richard Kirchgatter, Chairman  
Planning Commission

Publish: November 23, 1988  
December 14, 1988

**NOTICE  
CITY OF PLYMOUTH, MI  
WINTER TAXES**

Winter taxes are due December 1, 1988 payable through February 28, 1989 without penalty. Additional information appears on the reverse side of your tax statement. MAKE ALL CHECKS PAYABLE TO: CITY OF PLYMOUTH. Payments for tax bills and water bills can be made at City Hall-Treasurer's Office during regular working hours. Residents may make payments after hours by using the DROP BOX located next to the Treasurer's Office window. Payments for tax bills can also be made at COMERICA-LAKEPOINTE VILLAGE, FIRST OF AMERICA-PLYMOUTH AND NATIONAL BANK OF DETROIT-PLYMOUTH locations. The banks listed cannot accept payment of taxes after FEBRUARY 28, 1989.

Yes, a "SENIOR CITIZEN", defined as a person 65 years or older, who owns a dwelling and used it as their HOMESTEAD for at least 6 months of the year may qualify for a HOMESTEAD TAX REFUND FROM THE STATE OF MICHIGAN. Senior's who would like assistance in the preparation of their property tax form should contact the Plymouth Cultural Center for further information, (313) 455-6620, after February 1, 1989.

WILLIAM S. GRAHAM  
CITY CLERK

Publish: The Community Crier  
Wednesday, November 23, 1988



# Community opinions

## The Community Crier



THE  
NEWSPAPER  
WITH ITS  
HEART IN THE  
PLYMOUTH—

CANTON COMMUNITY

821 Penniman Ave.  
Plymouth, MI 48170  
(313) 453-6900

**EDITOR & PUBLISHER:**

W. Edward Wendover

**GENERAL MANAGER:**

Phyllis Redfern

**MANAGING EDITOR:**

Ken Voyles

**SPORTS EDITOR:**

Paul Gargaro

**SPORTS REPORTERS:**

Janet Armstrong

Rita Derbin

**REPORTER:**

Dan Jarvis

**PHOTOGRAPHER:**

Chris Farina

**BUSINESS MANAGER:**

Peg Glass

**BUSINESS ASSISTANT:**

Margaret Glomski

**OFFICE MANAGER:**

Charlene Kramer

**CIRCULATION MANAGER:**

Craig Videap

**ADVERTISING DIRECTOR:**

Paul McCormick

**ADVERTISING**

**CONSULTANTS:**

Michelle Tregembo Wilson,

Karen Gould, Peg Paul,

Jack Armstrong

**PUBLISHED EACH WEDNESDAY**

by The Plymouth-Canton Community

Crier, Inc.

**CARRIER DELIVERED**

\$1.25 monthly, \$14 yearly

U.S. MAIL DELIVERED: \$20 yearly

in U.S.A.



Recycle  
your  
newspapers!



NNA  
NATIONAL NEWSPAPER  
ASSOCIATION



A complete publishing company

345 Fleet St., Plymouth, MI 48170

(313) 453-6860

**SALES DIRECTOR:**

Jayne Rosser

**PRODUCTION MANAGER:**

Karla Frenzoz

**ASST. PRODUCTION**

MANAGER:

Stephen Wroble

**GRAPHIC ARTISTS:**

Dawn Phillips,

Shawn Guideau

**TYPESETTER:**

K.C. Loftus

# Strike up the band

Now that the Centennial Educational Park band is recognized as the fifth best marching band in the United States, won't it be great to watch them perform on national television in the Orange Bowl Parade?

The 161-member band is scheduled to make the Florida trip on Dec. 28.

But there's a catch.

And, as always, it's money.

To insure that none of the band members are denied the chance to participate because the \$530-per-student fee can't be met, the CEP Music Boosters are seeking generous support from The Plymouth-Canton Community.

Already, the band has received help from the Plymouth Rotary Club and several car dealers and merchants.

That's \$5,000 in, but \$35,000 more is needed -- and quickly.

To foster the educational experience for these young adults and to promote The Plymouth-



Canton Community nationally, send donations to:  
**CEP MARCHING BAND  
ORANGE BOWL TRIP**  
Canton High School  
8415 Canton Center Rd.  
Canton, MI 48187

(Or, for more information, contact Trip Chairman Linda Gasparott at 452-1905, or Booster President Judy Lore at 453-5181.)

There's no better way to recognize the achievement of the band being chosen fifth from among 54 high school marching bands nationally at the Bands of America Grand National Championship on Nov. 12.

As Jim Griffith, long-time band director for the school district, said, "We matched ourselves against the top bands in the nation and we showed we can hold our own. This is the highest honor we have ever received."

Let's congratulate the band members by sending them to the Orange Bowl Parade!

THE COMMUNITY CRIER

## Twp. makes waves in a strange brew

Hey fellas, I've got this big social malcontent on my hands and I'd like to lock him up for awhile so he doesn't try and stick a knife in my ear. Any suggestions?

Not now, we're in the middle of an 18 year court battle. Can't you see we're busy sticking our collective tongue out at the guys across the table?

And so it goes...

Wayne County needs to rectify the current ugly situation regarding the management of its jailhouse. The battle started some 18 years ago when inmates got the ball rolling to improve their living conditions, which weren't pretty at the time.

Today the fight rages on.

Among its key players are Wayne County Sheriff Robert Ficano, who maintains that he's doing his best in the face of costly court orders regarding the management of the prison. In another corner, we find Wayne County Executive Edward McNamara's band moaning over what they perceive to be the sheriff's inability to stay within the prison budget.

The other key combatant is the inmates original attorney Dick Skutt, who maintains that the whole situation has extended beyond the realm of

### The last detail

by Paul Gargaro



county and sheriff control and needs to fall under the omniscient control of a receiver.

As far as they know, they're all right. But from this position, it looks like a giant bowl of murky and unappetizing political soup.

Plymouth Township Supervisor Maurice Breen and his cavalry of trustees seem eager, despite outgoing Trustee James Irvine's caution, to ride to Ficano's rescue by opposing the jail receiver idea.

Will the township be sticking out its neck by taking sides?

Breen says "no" with a capital N. "I think we've got a right to intervene, it's a taxpayers case," said the supervisor.

Nevertheless, it will most likely make waves in an already strange brew.

Regardless of whose toes get

squashed and whose feelings get hurt, the time has come to put this 18-year-old headache to rest. Straighten out the differences and stop pointing fingers about who gave the prisoners video games and how many times a day they allowed to play checkers.

Let's hope Circuit Court Chief Judge Richard Kaufman can put a final nail in this coffin. After all, he is a Plymouth Township resident -- he should have some sense.

On another frustrating note, Stahl Manufacturing in Plymouth is still managing to outrage its neighbors along Ann and Junction streets.

The mud is running thickly out of its unpaved parking lot, trash continues to blow from its premises, and assorted other promised Stahl improvements remain unkept.

Outraged Stahl neighbor Bill Dolinski has been a constant at City Council meetings. Unfortunately, it seems that his patience is wearing understandably thin.

"I'm living next door to a trash dump," lamented Dolinski on Monday.

Chin up, Bill, maybe the Stahl plant will be accidently plowed away by an errant snow plow this winter.



# Community opinions

## With malice toward none



## Preniczky flaunts his ignorance again

One of the first housekeeping chores the new Canton Township Board will tackle is the sleepy matter of choosing a "legal" newspaper.

Under Michigan law, each governmental unit must designate an established print vehicle(s) to run those pages and pages of tiny type that few people read. Generally, the "legal" rate is about half or even less of what standard advertisers pay.

Currently The Community Crier carries Canton's legal notices.

The out-going board, having put the matter off too long, decided after much wrangling, that it was too close to elections to tackle the issue and left it for the new board.

Meanwhile, a Crier reader noticed a small matter in the minutes of a Canton board meeting and responded, by dashing off a letter to the board and to the newspaper.

This was of course doubly unusual -- rare that someone reads the minutes and rare that a citizen took the time and effort to stand up and be counted.

But what was even more peculiar, says the grapevine, is what happened next.

A Canton Township trustee, John

Preniczky, called the letter writer to ask where he'd heard his information. When the reply was that he'd read the board minutes in The Crier, Preniczky said, "You can't believe what you read in The Crier."

(Perhaps what this goofball trustee meant was, "You can't believe what happens at Canton meetings," since the minutes are run verbatim as supplied by the township clerk's office.)

Now perhaps the letter writer understands why if Preniczky has such little grasp of how township board minutes and legal notices are run -- not to mention his other undistinguished aptitudes -- The Community Crier's editorial board found it impossible to endorse his re-election. (This, of course, then leads Preniczky to proclaim to other board members, "I don't care who gets the legal notices as long as it isn't The Crier.")

No doubt, Preniczky will take the lead in moving the minutes to another paper -- rather than abstain, admitting he doesn't have a sufficient grasp on the matter to vote.

That is if the birds don't eat the breadcrumbs so he can't find his way to the township hall...

## Between the lines

by Dan Jarvis



What's it all about?

Communication, plain and simple. Recently, two surveys posed questions to residents of The Plymouth-Canton Community Schools regarding opinions on the Plymouth-Canton Community Schools.

The first was a non-scientific questionnaire that went to 176 members of the Parent Teachers Organization (PTO).

The second was a random telephone sampling of 419 residents conducted by the Citizens Researching Educational Workings.

In both cases the message was clear: the school administration and board of education have an image problem.

When PTO members feel there is a concern for the quality of education and residents feel there is a concern for money management and problem solving, it drives the point home.

In the midst of all this are the

children and young adults in the district.

Traditionally, the district has one of the best reputations in Southeastern Michigan. Judging by the performance of students scholastically and athletically, the problems don't seem to be rubbing off on the students.

Just ask the CEP Marching Band about several recent accomplishments.

The image problem seems to reside in the homes of residents upset with high taxes and the loss of traditional school programs.

But a funding problem for one, could be an image problem for another.

If the schools have the courage to put another millage proposal on the June ballot, vote 'yes'. Don't do it for the board or the administration, do it for the children.

No one ever said education in an open society would be cheap.

## Thanksgiving boycott?

EDITOR:

I feel that I would be ignoring good friends and neighbors if I failed to write this letter.

It seems that Meijer Thrifty Acres owners have decided to keep the Canton and Northville stores open on Thanksgiving Day.

While this might be a minor convenience for us as customers, it is a major insult to Meijer employees. They are being shown that their home lives and families are simply not important when Meijer customers might be coaxed into yet another shopping day.

These employees are not being offered a choice on whether they work or not on this most family oriented of holidays. But we, as neighbors and consumers do have a choice. We can choose not to patronize Meijer on Thanksgiving Day.

This is a national holiday! We all have the right to be home with our

families unless we are employed in a health or public safety related field.

If Meijer perceives this Thanksgiving opening as an economic success, next year all the surrounding stores will mercenary their lead. What a disgrace! Are we, at last, so mercenary that we can't stay away from the stores for one day? Can our retailers not spare one day's income? In a few more years, they'll probably be opening by noon on Christmas Day. That will give everyone time to rip open the goods and decide what needs to go back, and while they're at it, see what's on sale.

By the way, the Grand Rapids Meijer will be closed on Thanksgiving, because the owners believe that their residents are more "family oriented." What does that make us?

Come on, folks, let's stay away from Meijer in large numbers Thanksgiving Day.

MARY JANE DAZER

## In the margin

By Ken Voyles



Tom Yack is tired and frustrated by what he perceives as a lack of trust.

The new supervisor in Canton hasn't been on the job a week yet and he is already feeling the relentless pace of working for the Wayne-Westland schools during the morning and at Canton in the afternoon and evening.

A teacher with the system, Yack is trying to get to know his new post and prepare for a large number of housekeeping duties.

"I'm enjoying what I'm doing," Yack said, adding that he was tired after talking on the phone at the end of a long 14-hour day.

He is frustrated, too, by the rumours surrounding his planned leave of absence from the schools so that he can run the township. Yack said there is an atmosphere of mistrust in the township, and that people are questioning his plans.

"It's not as if I can get a leave tomorrow," he said, referring to his plans to apply for a leave that would take effect by the end of January. "I think the years of mistrust set the stage for this."

Yack, who was cautioned by the Wayne-Westland schools about his leave, said he will definitely get it in January and that residents shouldn't be concerned about his plans. Last night Canton's board was expected to consider making the supervisor post full-time again and increasing the salary to \$43,000, about the same as what Yack currently makes as a teacher.

"I don't sense any problems," he said. "It (the leave) will happen."

Some have expressed concern that Yack might be "double dipping," or

drawing two salaries, one from the school district and one from Canton, until he gets his leave. By that they are also implying that Yack may have other motives in taking on the unrewarding job of bringing Canton in the 1990s. That's just not true.

"It's only for five weeks," he said about the time he'll spend working the two jobs. Still that worries some who know how difficult it is to work two jobs in this day and age and retain a clear picture of what needs to be done. In government, that's dangerous even.

But Yack is a straight shooter. "I said all through the campaign that I thought Canton needed a professional," he said. "I think I can bring that to the position. I want to bring that to the position."

Some of the rumours about his reluctance to take the job may stem from his campaign statements concerning the need to hire an administrative assistant, someone who would be responsible to the supervisor.

"I still see the need for an assistant," Yack said. "But I never intended the idea as an effort to make the transition easier for me, or to buy time."

Yack sees an aid as another pair of arms and legs, someone who can help him with special projects and respond to the supervisor's general needs.

"If I can justify such a post I'll take it to the board," said Yack, adding that he will drop the idea if he cannot justify it. "There's a lot that needs to be done and we have other concerns."

Besides the possible hiring of an aid, Yack also wants to look at changing the board's by-laws so that the monthly meetings can be reduced from three to two.



## Sworn in

New board members in Canton and Plymouth township were sworn in Sunday and Monday. Left, Plymouth Township elected officials are sworn in Monday. New members are John Stewart and Ron Griffith. Right,



Canton's board is sworn in Sunday. New members include Tom Yack, Robert Shefferly and Henry Whalen, who was not present at the ceremony in the township's Administration Building. (Crier photos by Chris Farina)

*For hands-on experience . . .*

# Schools, Chamber apply for education grant

BY DAN JARVIS

The Plymouth-Canton Community Schools and the Plymouth Community Chamber of Commerce have applied for a \$5,000 grant to increase educational opportunities for students across the district.

Ray Hoedel, assistant superintendent for business with the schools, said the two entities have filed a joint request for the funds from the Michigan Department of Education to develop resources to provide students with hands on experience.

"If the grant is approved," said

Hoedel, "employees of local banks and retail businesses will go into the schools to teach practical learning. Also, students will have a chance to spend some time at local businesses, possibly in an intern situation.

"It serves as a bridge between different sources in schools and shows the students how they relate in the world of work," he added.

"It gives students a chance to try something out first," said Hoedel. "There is a lot of enthusiasm between the schools and the local chamber."

The Partnerships for Education program combines the talents, resources and expertise of educators and private sector personnel to address the needs of public schools. The program primarily serves non-college bound high school seniors experiencing academic difficulty.

Mary Roehr, executive chamber director, said the program is designed to augment the standard course of subjects taught at the schools.

"I think our world is becoming more technical and diversified," said Roehr.

"The schools are teaching basic subjects such as reading, writing and arithmetic. Business people today need other skills.

"Learning is a lifelong process, said Roehr. "Sometimes students need a better understanding of the working world. This program is designed to do that."

Roehr said the Michigan Department of Education is expected to inform the chamber and the schools of the grant status by mid December.

## MLC Corp. receives permission to relocate

BY KEN VOYLES

The M.L.C. Corporation in Canton received permission to relocate to Plymouth Township during the regular meeting of the Canton Board of Trustees last week.

M.L.C., located in Canton since 1985, needed approval to leave the township so that it would be eligible for a Public Act 198 tax abatement through Plymouth Township, according to David Nicholson, director of Canton's Community and Economic Development Department.

"We have to release them so they can move and get the benefits," Nicholson told the board.

According to a M.L.C. spokesperson, the company, which is located on Ronda Drive, is expanding and needs a larger facility.

Apparently a realtor found property in Plymouth Township, but did not locate any in Canton, said the spokesperson, who added that M.L.C. would have stayed in Canton if a piece of property had been found in the township.

The company has not received a tax abatement from Canton, however. The spokesperson said company officials did not know that that option existed when M.L.C. moved to Canton.

"This does not automatically give them an abatement in Plymouth Township," said out-going board member Robert Padget. "But if we deny this it could happen to us."

By releasing the company Canton makes it possible for M.L.C. to apply for a 12-year tax abatement in Plymouth Township.

The company currently employs nine people.

## Cops train

Last week Sgt. William Lenaghan and Sgt. Ernie Sayre of the Canton Police Department completed an interdisciplinary leadership training course sponsored by Northwestern University School of Police Staff and Command.

### To benefit schools

## EEF allocates 19 grants

Bright ideas that cost a little extra may get a special boost in The Plymouth-Canton Community thanks to the Education Excellence Foundation (EEF).

The organization which accepts and invests money for the benefit of the Plymouth-Canton Community Schools offered mini-grants as an incentive for development of new teaching and learning techniques for the past two years to teachers in the district.

The EEF has allocated up to \$3,800 for 19 grants of \$200 each.

Some of the projects funded this year will provide a computer lab at Farrand Elementary School, a science center at Miller Elementary School and a printing center at Smith Elementary School. Individual teachers have also asked for funds to enrich reading, science, industrial arts, art, foreign language and history.

The grants will go for projects during the 1988-89 school year. Thirty-three requests for a total of \$6,359 were received by the Sept. 30 deadline, but the EEF was able to fund only 22 requests.

The foundation, run by private citizens, is completely separate from the school district, and provides a mechanism for individuals to provide money through a general endowment fund to the schools.

Donations are tax deductible and may be sent to the Education Excellence Foundation, P.O. Box 449, Plymouth 48170.



# Twp. gets in middle of prison fight

Continued from pg. 3

Wayne County Deputy Executive Mike Duggan disagrees.

Duggan said that in 1987 a monitor, Vince Nathan, was hired to observe the jail situation and report back to the judge. Duggan said Nathan was Ficano's choice.

"He (Nathan) wrote a report saying that there were gross incompetencies and that the sheriff's management was inept," said Duggan.

Ficano, however, said the operation of the prison has been adequate.

"If you look at where we are on a national level, we rank very high," said Ficano.

Duggan also blamed the placement of video games in the prison on Ficano.

"I don't think of them as recreational," said Duggan. "But our gripe is that he's running \$2 million over budget. He's a one man deficit. He's spending us back to financial difficulties."

Ficano said he does not take the blame for surpassing the budget.

"Leroy Lemon (of the Alberta Easter - Inkster police shooting) cost the county \$130,000 to run his dialysis machine while he was there waiting for his trial. How can you budget for that?" asked Ficano.

Plymouth Township Supervisor

Maurice Breen agreed with Ficano's opposition to the implementation of a receivership.

"Money's being syphoned off for somebody's concept of what life is supposed to be like for prisoners," said Breen. "I don't think anyone is representing the taxpayers. I'd like to see the township take a role in supporting opposition to the receivership."

"Why should we hire a receiver to do an elected official's job? If he (Ficano) is not doing the job then take him to task - but I don't think that's the reason. It seems to me that the standards are being met," added Breen.

"We've moved for a receivership because Ficano is pointing a finger at (Wayne County Executive Edward) McNamara and McNamara is pointing the finger at Ficano," said inmate attorney Dick Skutt. "The people in charge haven't been able to run this properly for the past 18 years. Outside expertise has to be brought in."

Wayne County Circuit Court Chief Judge Richard Kaufman said briefs and motions on the case are due on Dec. 7. The township attorney is expected to present the board of trustees with an estimation of the costs and ramifications of their opposition to the jail being placed under receivership at the Nov. 29 meeting.

PG. 9 THE COMMUNITY CRIER: November 23, 1988

## Coming Dec. 14

### our annual

## 'Dear Santa' Plus

*This is one of our favorite sections. Wonderfully amusing and touching, this pullout section is made up of your children's letters to Santa.*

*In this edition we also publish the winning entry of our coloring contest. This section is treasured by our readers!*

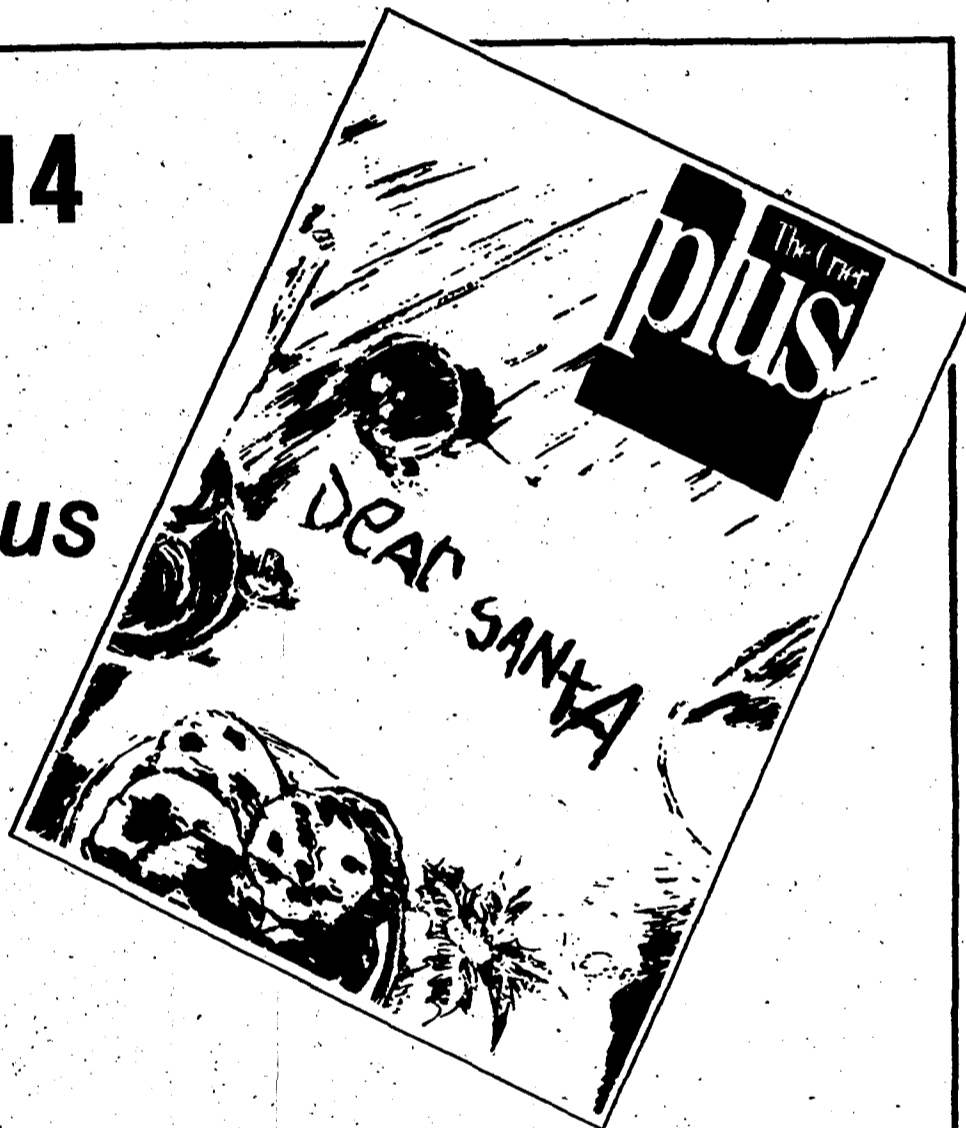

## Advertisers, call your Crier Ad Consultant Today

# 453-6900

 **The  
Community Crier**

531 Peachman • Plymouth, MI 48170 313-453-6900



# Friends & Neighbors

## A day at the pizza parlor

### 1) Patting out dough



What could be more fun for kids than pretending to make pizzas in their own pretend pizza parlor? Making pizzas for real!

And real-life learning is part of the theory behind a recent visit by Bird Elementary School kindergarteners to a pizza parlor in Plymouth.

Kindergarten teacher Linda Bright and her class began with a pretend pizza parlor where students learned about various aspects of planning and cooperation in a group setting.

Bright realized that a real-life experience may be more meaningful, and called to arrange for a trip for her 22 students to a real pizza shop.

"The kids were having so much fun," said Bright, "and they learned. That's really important."

"The whole idea was to incorporate writing, reading and role playing" said Bright. "They learned that it takes cooperation in dividing the work, and that there is a lot of responsibility in any venture."

Twenty-two kids, 11 pizzas and lots of smiles is a great way to learn. And as Bright said, they will always remember their fun trip to a real-life pizza parlor.

**Crier photos and text by Dan Jarvis**



### 3) Extra items? ... No problem!

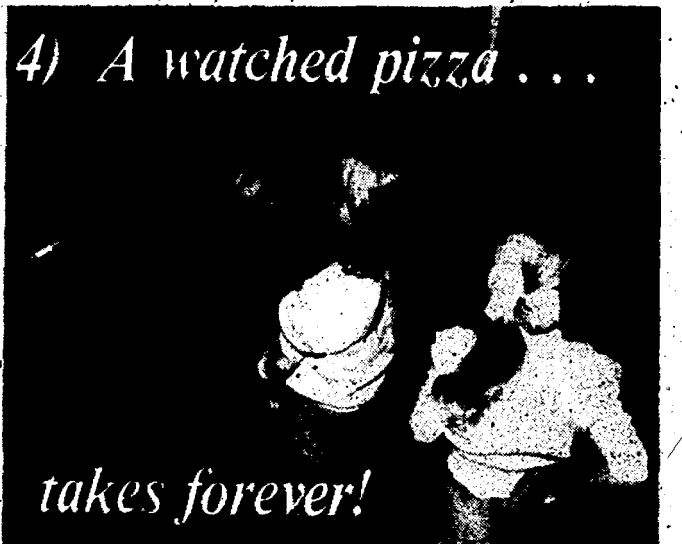

### 4) A watched pizza ... takes forever!

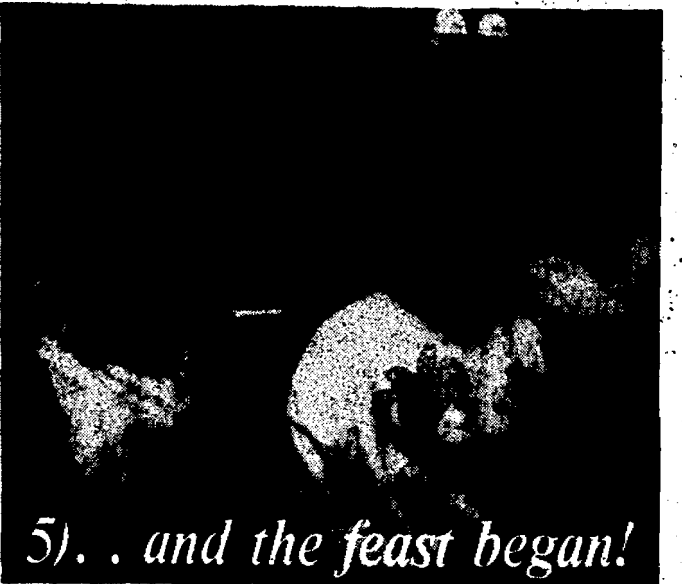

### 5) ... and the feast began!

### 2) Spreading the sauce



1) Kelly Stevens gets a lesson in making pizza dough, as Jennifer Frederick pays close attention. 2) Timothy Stamp likes a lot of sauce on his pizza. The students had the chance to lay the sauce on thick. 3) Helper (and mother) Linda Brennan helps kindergarteners pile on the ingredients of their choice. Kris Millman (left) and Christopher Seavitt work on one pizza while classmates down the line custom-design their own. 4) Christina Porfidio (left) anxiously awaits her pizza's arrival from the oven as classmates Kris Millman and Kristen Janz look on. 5) Adrienne Sloat (left) and pizza-buddy Tara Brennan share in the feast back at Bird Elementary School.

#### GYMNASTIC FUN!

Classes for Girls & Boys,  
& Preschool  
Michigan Academy of  
Gymnastics

5930 N. Hix Rd. (Ford Rd & I-275)  
Westland, Mich. 48185  
CALL: 721-4001

#### Visions In Wood

Specializing in Hand Crafted  
Accessories for your Home.  
Tables • Shelves • Outdoor Furn.  
Victorian • Early American  
Clocks — Restore or Custom

453-7751  
696 N. Mill St. • Plymouth

**WVDD**  
THE BOTTOM LINE  
Mon. - Fri.  
Listen to the 88 Escape  
After the 6 pm News  
PLYMOUTH CANTON S RAD O STATION

#### Full Service Publishing

**Comma**  
COMMUNITY COMMUNICATIONS  
(313) 453-6860

# Tell it to Phyllis

By Phyllis Redfern



Thanksgiving marks the beginning of the holiday season.

As Americans gather together tomorrow to watch the Santa parades, the football games and eat a big turkey dinner, how many will remember why we celebrate this holiday?

Ask the kids in the family what Thanksgiving means. Many of them have been doing art projects in school centering around Pilgrims and Indians.

Does anyone know why we always serve turkey and pumpkin pie on Thanksgiving? I can picture Indians roasting a turkey on an open fire, but somehow I have trouble trying to imagine how the Pilgrims could bake a pumpkin pie. I wonder what the food really looked and tasted like on that first Thanksgiving. (I bet they didn't consume as many calories as we will tomorrow.)

Thanksgiving is a time to be together with family and friends. It's a time for hugs, sharing and simply enjoying each other. It is also a time to be thankful, not only for all the food and things we have, but mostly for the fact that we can be together.

As we look around us, some of our friends have lost someone very special to them this year. These are the friends we need to remember with an extra hug.

We all have so many things to be thankful for. The people in this country have much more than people in many other countries.

I guess Thanksgiving does mark the beginning of the holiday season, but it is a separate holiday, not part of Christmas or Chanukah. I know some people have already started their holiday shopping and baking and I admit to being a bit envious. I realize with work schedules people should plan ahead for the holidays. I honestly would like to be organized enough to do that some year.

Each year the stores start decorating earlier and earlier for the holidays. Santa even arrives at some of the malls before Thanksgiving.

I don't want Thanksgiving to get buried and forgotten. It is a special holiday. We all need to take time from our busy schedules to be thankful for our friends and families and enjoy them.

**HAPPY THANKSGIVING!**

\*\*\*\*

Gabriel Krawczak, son of Carol Krawczak of Lynn Drive in Plymouth, has completed training in fundamental military skills at the Army ROTC Camp Challenge at Fort Knox, KY. He is a student at MSU.

\*\*\*\*

Students from Plymouth who were admitted to MSU's Honors College are: Diana Baumgartner, daughter of Richard and Lee Ann Baumgartner of N. Territorial; and Julie Zasadny, daughter of Tom and Geri Zasadny of Creekwood.

## Applications available Ice Sculpture Fest

Applications are currently being accepted from chefs and ice carvers for the annual Plymouth Ice Sculpture Spectacular, one of the nation's largest ice sculpture competitions.

The 7th annual event is slated to be held from Jan. 5-15 in Kellogg Park in downtown Plymouth.

This year there will be a new three-man, five-block regional competition added to the other ice contests. It will be held under the auspices of the National Ice Carving Association.

There will also be the other two regular divisions -- one for students, which begins on Jan. 7, and one for professionals, which begins on Jan. 14.

More than 100 chefs from throughout the United States are expected to enter the competition.

Applications are available by calling Paul Sincock, assistant city manager, at 453-1234. Competitors can also write to 201 S. Main, Plymouth 48170 for a competition application.

If you live in Plymouth or Canton and want to learn the Martial Arts — there is only one right move ...



### to KIL'S TAE KWON DO

- WHAT:**
- Tae Kwon Do
  - Karate
  - Physical Fitness
  - Relieves stress — and the discomfort caused by Asthma
  - Ju-Do
  - Self-Defense
  - Protection
  - Hapkido
  - Weapons
  - Confidence
- WHEN:** Classes 6 Days a week — Mon.-Fri. 11-8:30 and Sat. 12-5



Master Instructor  
Sang Sop Kil  
8th Degree Blackbelt

Kil's Tae Kwon Do is not a part time class taught by inexperienced instructors. We are the U.S. Tae Kwon Do Han Moo Kwan Headquarters complete with Olympic Training Center. If you are serious about learning the martial arts — call us now.

**2 For 1  
Holiday  
Membership  
Special!**  
thru Dec. 31, 1988  
Ask for Details

**KIL'S TAE KWON DO**  
Call **454-0660**  
Martial Arts Supplies  
45168 Ford Rd., Canton  
(Across from Mejers Thrifty Acres)  
or Call **454-0662**

## SnugFleece® guarantees you a better night's sleep.

SnugFleece is a luxurious two-inch thick New Zealand wool underlay that is positioned on your bed between the mattress and the bottom sheet. This cushion support helps soothe back and muscle ache. The wool pile assists in evenly distributing body weight and easing pressure points, ensuring a more restful, comfortable sleep.

The SnugFleece pure wool mattress pad is the best made. It features nearly twice the wool content of its competitors.

We invite you to try one for 90 nights. If, after 90 nights, you're not sleeping more comfortably with fewer aches and pains, we insist you return it for a full refund—no questions asked!



"SnugFleece has given me the best rest and sleep I've had since I was a kid."  
Ernest Borgnine

**IMPORTED, PURE WOOL MATTRESS PADS  
ARE AT THESE COMFORTING PRICES**

- TWIN SIZE \$115
- QUEEN SIZE \$189
- FULL SIZE \$149
- KING SIZE \$249

**THE PERFECT GIFT!**



**Walker/Buzenberg**  
fine furniture

240 NORTH MAIN STREET • PLYMOUTH • 459-1300  
(Two blocks north of Downtown Plymouth)

Mon., Thurs., Fri. 10-9; Tues., Wed., Sat. 10-6

**ONE  
STOP**

**Full Service Hobby Shop  
Specializing in Radio Control  
Cars, Trucks and Our Customers!**



**HOBBIES**

- searching for the latest Design Kits
- waiting for parts
- over-spending
- wishing for service
- in and browse

Our Hobby Shop has a computerized hook-up to our distributors enabling us to order hard-to-find merchandise and parts **IMMEDIATELY.**

38655 Ann Arbor Rd. **462-0001**  
(One mile East of I-275)

Mon. - Fri.	10-9
Sat.	10-7
Sun.	11-4

Bring Ad & Get FREE Can of RC paint with any RC Kit Purchase.

**PORTRAIT AMERICA**

**WE MAKE HOUSE CALLS!!**

**AFFORDABLE CHILDREN & FAMILY  
PORTRAIT PHOTOGRAPHY IN THE  
CONVENIENCE OF YOUR HOME**

**NO SITTING FEE... YOUR CHOICE OF PROOFS  
PORTRAIT AMERICA OF CANTON 454-1200**

**ONE 8 x 10 CUSTOM COLOR PORTRAIT  
FOR ONLY \$10.00**

OR  
**FREE WITH ANY PACKAGE ORDERED  
STILL TIME FOR HOLIDAY DELIVERY.**



**This holiday season, Apple  
makes it easy.**

Now is the best time to buy an Apple® II or Macintosh® computer. Because if you make your purchase with the Apple Credit Card, you can take your system home the same day, with no payments and no finance charges\* billed until February '89.

Put a Macintosh Plus to work in your home office and watch the productivity begin! Team up your Macintosh computer with Macintosh Works™ software and you can create customized letters, memos, and proposals, turn big tasks like budgeting and financial analysis into small ones, and get the power to manage a mountain of information.

If you need more powerful options, get the Macintosh SE for your business' growing needs. The expanded storage capacity of the Macintosh SE allows room for large spreadsheets and databases, and powerful word processing programs. Plus, with the built-in expansion slot, you can plug in large screen monitors or special application cards.

The compact, affordable Apple IIe Plus makes an excellent gift for the entire family. It's the perfect solution for first-time buyers who want an affordable, easy-to-use computer. And along with Claris' AppleWorks® there's something for everyone in your family. AppleWorks

combines word processing, spreadsheet, and database management in one software package.

Last, but certainly not least, the Apple IIe™ may be one of the most remarkable personal computers you've ever seen... or heard. It features highly sophisticated graphics capabilities that allow the artist in you to draw, paint and design in over 4,000 brilliant colors. And the Apple IIe can recreate up to 15 different sounds simultaneously. With Claris' AppleWorks GS™,

you'll get virtually everything your family needs for personal productivity: word processing, with spell checker and thesaurus; mail merge; spreadsheet, database management, desktop publishing, and more.

Hurry in today for more information about how Apple makes it easy this holiday season.



**COMPUTER CONNECTION** 44473 Ann Arbor Road  
Plymouth, 455-2983

© 1988 Apple Computer, Inc. Apple, the Apple logo and Apple II, Macintosh and Macintosh Plus are registered trademarks of Apple Computer, Inc. Macintosh Classic, Macintosh SE, Macintosh Plus, and Macintosh IIe are trademarks of Apple Computer, Inc. AppleWorks and AppleWorks GS are trademarks of Claris Corporation. AppleWorks GS requires 2MB of additional memory to run on an Apple IIe. \*AppleWorks GS requires 2MB of additional memory to run on an Apple IIe. †1988 model Macintosh requires 2MB. All other models require a Macintosh Plus.

Now Open Sundays 12-4



**What's happening**



To list your group's event in this calendar, send or deliver the notice **IN WRITING** to: The Crier, 821 Penniman Ave., Plymouth, MI. 48170. Information received **BY NOON FRIDAY** will be used for Wednesday's calendar (space permitting).

**MUSICAL ON ICE**

The Plymouth Figure Skating Club will host a "Christmas Musical on Ice" at the Plymouth Cultural Center on Dec. 9 at 6:30 p.m. Tickets are \$3 for adults, while children 12 and under get in free. Tickets available at the door. For information call 420-0194.

**SENIORS LUNCHEON**

Senior citizens are invited to the monthly luncheon at noon on Dec. 5 in Fellowship Hall, First United Methodist Church, on North Territorial Road. There will be a Christmas program. Tickets are \$4 each and reservations may be made by calling 453-6271. Must be made by Nov. 30.

**FROM ST NICK TO SANTA**

The Woman's Club of Plymouth will meet at 12:30 p.m. on Dec. 2 at the First Presbyterian Church on Church Street in Plymouth. The program is "From Saint Nicholas to Santa Claus." Members are asked to bring scarves and mittens for the "Mitten Tree" of canned goods for the Salvation Army.

**AMATEUR RADIO GROUP**

The Stu Rockafellow Amateur Radio Society meets regularly in City of Plymouth City Hall once a month. Open to those interested in amateur radio. Held in the commission chambers on the second floor on the third Tuesday of each month at 7:30 p.m. Call 453-8123 for further information.

**CAREER WORKSHOP**

Schoolcraft College's Career Planning and Placement Center is hosting a career choices workshop on Nov. 29 from 6-8 p.m. at the Radcliff Campus in Garden City. Free of charge and open to the public. For information call 462-4421.

**ART CLUB MEETING**

The Three Cities Art Club will hold its Dec. 7 meeting at a members home due to the holiday season. The group's regular open to the public meetings will resume on Jan. 2 at the Plymouth Township Hall.

**HOLIDAY LUMINARIES**

Holiday luminaries will be sold from 10 a.m. to 4 p.m. on Dec. 3, 10 and 17 at the Westchester Square Mall and at the K-mart on Ann Arbor Road in Plymouth on Dec. 10, 17. Price is \$2.50 for a set of 10 candles with white bags. For further details call 459-1999 or 455-7494.

**GREENS MART AND BAKE SALE**

The Plymouth Branch of the Womens National Farm and Garden Association will host its annual Greens Mart and Bake Sale on Dec. 2-3 from 10 a.m. to 3 p.m. in the Mayflower Hotel. For details call 455-4427.

**PCAC HOLIDAY CARDS**

The Plymouth Community Arts Council (PCAC) has holiday greeting cards for sale. A package of 25 cards and envelopes costs \$10. The cards may be purchased at the PCAC office on Main Street (455-5260). They will also be available at a variety of shops in Plymouth.

**HOLIDAY HOME DECORATING CONTEST**

Nominations for the 2nd Annual Holiday Home Decorating Contest will be accepted by the Beautification Committee from December 1st to December 14th. Award winners will be announced the week of December 19th. Address your nominations to: Eileen Woljcik, Chairperson, Holiday Home Decorating Contest 44666 Twyckingham, Canton, MI 48187.

**GUARANTEED WHITE XMAS**

Canton's Parks and Recreation Dept. is sponsoring its 4th Annual Guaranteed White Christmas Contest for Canton residents beginning this week. Winner will be picked on Dec. 19. There is no charge. Open to Canton residents only. Win a truckload of snow. Entry forms at the parks and recreation office. Entry deadline is Dec. 16. Call 397-5110 for details.

**FRIENDS OF CANTON LIBRARY**

The Friends of the Canton Public Library will hold its general membership meeting on Nov. 30 at 7 p.m. in the conference room of the new library. All members and prospective members are welcome. Call Joyce at 397-0999 for details.

# What's happening

Tuesday  
18

To list your group's event in this calendar, send or deliver the notice IN WRITING to: The Crier, 821 Penniman Ave., Plymouth, MI. 48170. Information received BY NOON FRIDAY will be used for Wednesday's calendar (space permitting).

## OV CHRISTMAS WALK

The 17th Annual Christmas Walk in Plymouth's historic Old Village is slated for Sunday, Nov. 27 from noon to 6 p.m. Visit Santa, shop or take a pony wagon ride.

## HOLIDAY ARTS AND CRAFTS

The City of Plymouth Parks and Recreation will host its annual Christmas Arts and Crafts Shows on Nov. 25-27 and Dec. 2-4 at the Plymouth Cultural Center. Admission and parking are free. More than 75 artisans. Call 455-6620 for information.

## COMMUNITY CHORUS SHOW

The Plymouth Community Chorus will perform "Merry Christmas With Love" on Dec. 2-4 at the Salem High auditorium. Shows at 8 p.m. on Friday and Saturday and 4 p.m. on Sunday. Tickets are \$5 for adults and \$4 for seniors and children. For ticket information call 455-4080.

## CAREER PLANNING PROGRAM

Canton High will be the site of the CPP Test (Career Planning Program) for 11th and 12th grade students on Dec. 3. Registration runs through Nov. 28. There is a \$4.50 fee which must be paid at sign-up. Call 451-6600 for details.

## ART SHOW AND SALE

The Three Cities Art Club will host its Christmas Art Show and Sale in the Charlestown Square Mall on Nov. 26-27 from 10 a.m. to 5 p.m. For further information call 455-5805.

## GOODFELLOWS MEETING

The Plymouth Goodfellows will meet at Plymouth City Hall at 7:30 p.m. on Nov. 30. The group, along with Canton Goodfellows, will conduct their newspaper sale on Dec. 3 starting at 9 a.m. For more information call 453-7284 or 453-4987.

## MADONNA SIGN-UP

Open registration for the winter term at Madonna College will begin Dec. 5 through Dec. 22 for returning students and will resume on Jan. 3, 1989. Held in the Administration Building. For details call 591-5052.

## USED SPORTS SALE

The 4th Annual Used Sports Equipment Sale is Dec. 3 from 10 a.m. to 2 p.m. in the Canton Administration Building. For further information call 397-5110.

## PIONEERS SENIOR CLUB

The Pioneers Seniors Club of Canton meets at 12:30 p.m. on Fridays at the Canton Recreation Center. New members welcome. For information call 397-1000, ext. 278.

## THANKSGIVING SERVICE

The First Church of Christ, Scientist on Ann Arbor Trail will host a one-hour Thanksgiving service on Nov. 24 at 10:30 a.m. Call 453-1373 for details.

## MS SUPPORT GROUP

The Multiple Sclerosis (MS) West REMS Group (Recreation Education for MS) meets at 2 p.m. on the third Sunday of every month at St. Kenneth's Church in Plymouth. Call 453-0562 or 455-2461 for further information.

## ST JOHN NEUMANN SENIORS

The 50-Up Club will host its annual Christmas Party at LeRights on Dec. 6. For further information call Terry Brunner at 495-0026.

## THANKSGIVING LUNCHEON

The Canton Senior Citizens will host their annual Nutrition Program Thanksgiving Luncheon on Nov. 28 at 11:30 a.m. in Canton's Recreation Center on Michigan Avenue. Reservations must be made by Nov. 18 by calling 397-1000, ext. 279. For residents 60 and over there is a \$1 donation. Younger guests pay \$2.80.

## MATERNITY FITNESS PROGRAM

The University of Michigan Medical Center is offering medically approved maternity fitness classes at the M-Care Health Center in Northville. The Tuesday and Thursday evening classes start on Nov. 28. Call 936-5186 for more information on fees and sign-up.



## Country Crafts Show

Over 100 Country Craftsmen

LADBROKE DRC

28001 Schoolcraft

Livonia, Michigan

I-96 & Middlebelt

November 25, 26 & 27

Friday,

11 a.m. - 8 p.m.

Saturday & Sunday

10 a.m. - 6 p.m.

291-1934

All Victorian & Country Needs Available.



Wide Variety of  
Permanent & Fresh  
Christmas Decorations

Unusual Ornament Selection

Ribar Floral Co.

728 S. Main St., Plymouth

455-8722

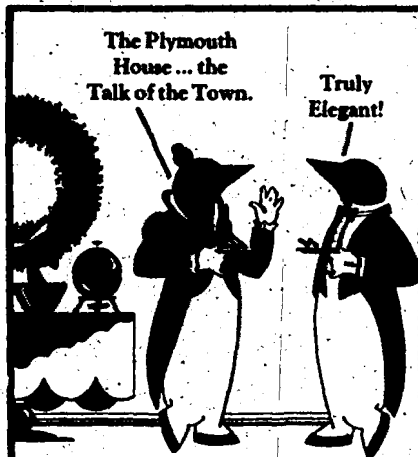

The Plymouth  
House ... the  
Talk of the Town.

Truly  
Elegant!

Everybody's talking about  
Plymouth's exciting new  
banquet facility ....

The  
Plymouth  
House

Catering & Banquet Hall  
345 N. Main St., Plymouth

Specializing in Weddings, Showers,  
Banquets, Corporate & Private  
Parties for all occasions.

Seating for over 550 guests  
with 3 separate ballrooms  
& parking for 225 cars

Contact Nick Ristich  
455-3501 or 455-3511  
Now Accepting Immediate  
Bookings for Holiday Parties.

## Homeowners discounts

John E. Tripp, Sr.

Agent

453-3642

865 Penniman Ave., Plymouth  
State Farm Fire and Casualty Company  
Home Office Bloomington, Illinois



We take care  
of every  
inch



Dr. Richard Heligman

Medical and Surgical Foot Specialist

455-3669

Family Foot Care

1360 S. Main

1 block North of Ann Arbor Rd.

Saturday Appointments Available

Most Insurance Plans Accepted

No Charge for Initial  
Consultation with this Ad.

(Excluding X-Rays, Lab Tests and Treatment)

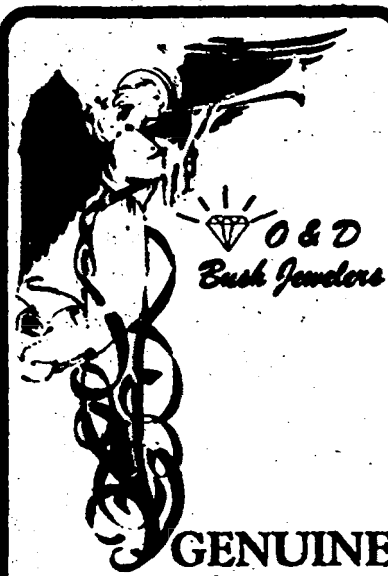

O & D  
Bush Jewelers

GENUINE  
STONE  
RINGS

from

\$99.00



Extended Christmas  
Hours  
OPEN SUNDAY

FREE Gift Wrapping

O & D  
Bush Jewelers

455-3030

481 Ann Arbor Tr.  
Plymouth

# Communities move ahead on authority

Continued from pg. 3

acting as a contract agent with vendors. "Technically the city owns the building until the bonds are paid off," he said.

Graper said Plymouth would turn the court over for \$1 when the bonds were paid. "Until they are paid it is our obligation to keep up the building," he added.

Garber also said the authority would be a "model" since there are not too many other court districts that encompass five communities.

"We've been very fortunate that we can give the five communities to participate," said Plymouth Township Supervisor and advisory council member Maurice Breen. "I think it's (the document) clean and I don't have any problem with it. I don't think it will have an impact on the day to day operation of the court."

"It goes more to form than anything else," Breen added.

"The feeling was we ought to think

about this now and not wait 20 years," said Graper. "We decided let's do it now and get it done with."

"I think we have to do this," said Brown. "We are a participant financially."

Brown added that maintaining the building was a concern both of stockholders and council members. He said the court needs a new roof among other repairs.

Both Brown and Jame Poole, Canton's outgoing supervisor, have said there was confusion over who owned the building and the site.

At a recent Canton board meeting Poole said that when the court was constructed it was agreed that it would be owned by all five communities and an authority and not one community.

Graper agreed, saying all five communities currently support the debt and operations costs, but he added that it would have been "smart" to form the authority when the court was built.

Graper added that Plymouth donated the land for the site back in 1981. He added that when the court was built "the financial structure of the court was not good."

"We weren't paying out way," he said. "That's been transformed dramatically to where we're now a revenue producing court as is most district courts."

Graper said the original formation of a single court was a simple effort to consolidate the operations, reduce expenditures and split the revenues more equitably. Each community gets a percentage of the revenues generated from ticket fines.

Garber said that when the court was built the five communities pledged revenues to retire the bonds as well cover maintenance costs.

"We started out to be an authority at some point a long time ago and just never got around to it," said Georgina Goss, Northville Township Supervisor and council member. "It should make the court more efficient."



The 35th District Courthouse on Plymouth Road in the City of Plymouth. (Crier photo by Chris Farina)

## Court generates \$2 million

The 35th District Court has an annual operating budget of \$1.2 million with roughly \$86,000 going to pay utilities, maintenance, and insurance on the grounds and building, said Judge James Garber.

Annual utility bills cost the court approximately \$40,000 while annual maintenance is about \$30,000.

The cost of insurance on the grounds and structure is \$16,000 said Garber, who stressed that the amount includes the cost of bonding employees against possible theft.

About \$850,000 goes out to pay employees' salaries and benefit packages, which includes retirement.

An additional \$142,338 is spent yearly to pay off the debt on bonds to the City of Plymouth.

While Garber could only project the 1988 revenues, he said he expects the number to be close to \$2 million. Of that amount, approximately \$1.6 million is derived from tickets, fines and costs paid by offenders.

Garber said an additional \$350,000 is gained through miscellaneous costs such as probation and bonds.

## TRIAL LAWYERS

SPECIALISTS IN PERSONAL INJURY LITIGATION AND OTHER MATTERS

BODILY INJURY CASES — AUTO, TRUCK, BOAT, MOTORCYCLE, AIRPLANE

MALPRACTICE — PHYSICIAN, HOSPITAL, DENTAL, OTHER PROFESSIONALS

INJURIES FROM DEFECTIVE PRODUCTS

WORKERS COMPENSATION — SOCIAL SECURITY

SLIP AND FALL INJURIES

CONSTRUCTION SITE ACCIDENTS

WRONGFUL DISCHARGE, CIVIL RIGHTS, DISCRIMINATION CLAIMS

DIVORCE, CRIMINAL, DRUNK DRIVING

• NO FEE FOR INITIAL CONSULTATION

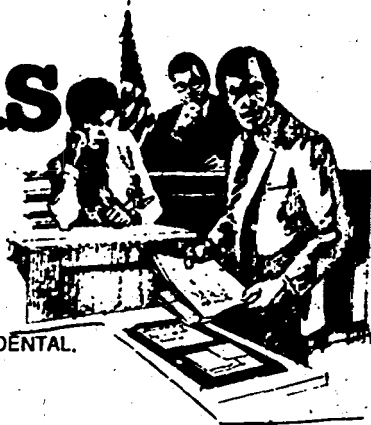

OTHER MATTERS: GENERAL AND COMMERCIAL LITIGATION, BANKRUPTCY, TAX, REAL ESTATE, ESTATE PLANNING

**Sommers, Schwartz, Silver and Schwartz, P.C.**  
Over 50 Lawyers Associated with Firm • Serving You for Over 40 Years

CALL FOR APPOINTMENT at Our Plymouth or Southfield Office.

**John F. Vos III**  
**455-4250**

747 S. MAIN • PLYMOUTH



## Church Directory

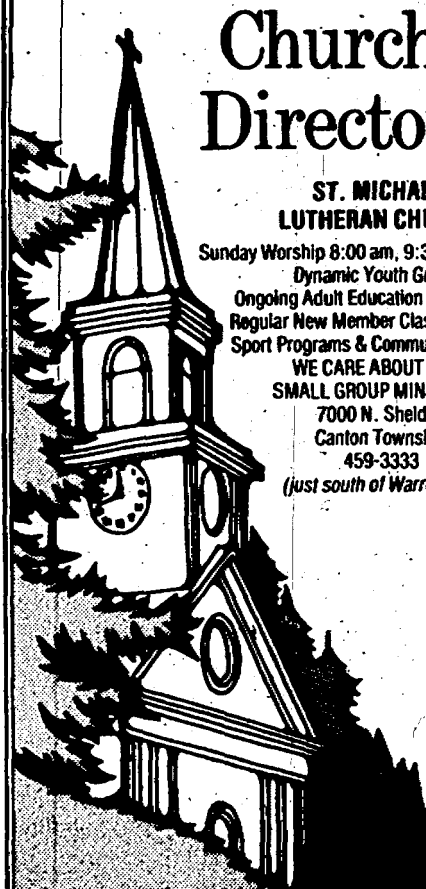

**ST. MICHAEL LUTHERAN CHURCH**  
Sunday Worship 8:00 am, 9:30 am & 11:00 am  
Dynamic Youth Groups  
Ongoing Adult Education & Fellowship  
Regular New Member Classes Available  
Sport Programs & Community Outreach  
WE CARE ABOUT YOU:  
SMALL GROUP MINISTRIES  
7000 N. Sheldon  
Canton Township  
459-3333  
(just south of Warren Road)

**GENEVA PRESBYTERIAN CHURCH (USA)**  
5835 Sheldon Rd. Canton  
459-0013  
Worship Service & Church School  
Sunday 9:15 & 11:00  
Kenneth F. Gruebel Pastor

**WEST PLYMOUTH COMMUNITY CHURCH (SBC)**  
SW corner of Ann Arbor Tr. & Sheldon  
Christian Education 9-10 am  
Discipleship Groups  
Tue. & Wed. 7:30 pm  
Sunday Worship 10-11 am.  
Phil and Diana Rogers  
459-5775

**CALVARY BAPTIST CHURCH**  
43065 Joy Road, Canton  
455-0022  
David A. Hay, Pastor  
Sunday School for All Ages 9:45 am  
Sunday Services 11:00 am, 6:00 pm  
Wednesday Bible Study & clubs 7:00 pm  
Plymouth Christian Academy 459-3505

**PLYMOUTH BAPTIST CHURCH**  
42021 Ann Arbor Trail, 453-5534  
Sunday School 9:45 am  
Sunday Morning Worship Service 11:00 am  
Sunday Evening Service 6:00 pm  
Wednesday Night Family Night 7:30 pm  
Pastor Philip Fitch 531-8456  
Bible Oriented Ministry

The Crier

# PLUS

## *Home for the Holidays 1988*

*What is it really? Ask your life, ask your God.*

*The answer is within both -- a natural season of celebration, a time for rejoicing in those eternal, mortal guises we don for him, for ourselves; now all is bound by the landscape inside, strokes brushed in many colors of the one white.*

*The question is within both -- days worth holding on to, like a time of birth, or bowing to the deep faith hidden in treasure feelings; now all is bound by night, as near to you as we can, a touch away by soft command, still seen by visions of life.*

*What is it really? Ask yourself, ask another.*

*The answer is the same -- beyond words, sweet simple or lazy grand, beyond the touch of man's intruding desires; now an upbeat wave dashing onward, shaped under brightly kept skies, morning surprises.*

*Bring on wonder --  
holiday spirits.*

*Let it be as life demands.*

*K. H. VOYLES*

# SPA & TUB WORLD INC.

WISHES YOU

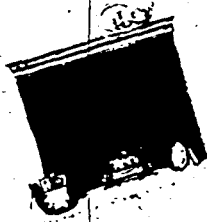
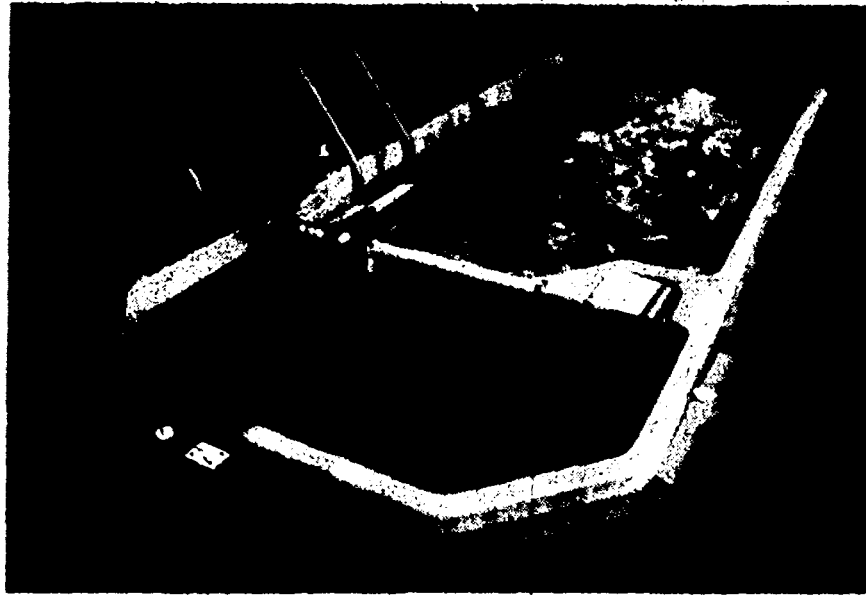
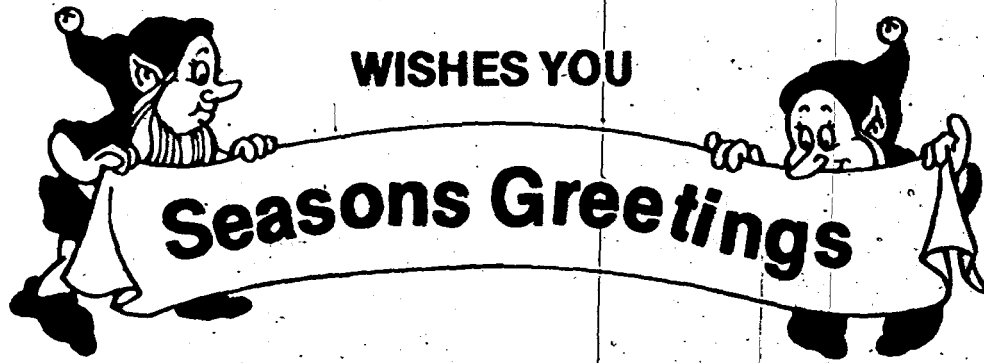

Custom Built  
Fire Places

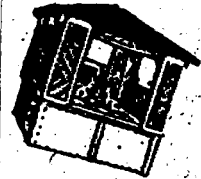

Custom Built  
Gazebos

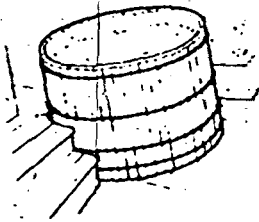

Hot Tubs

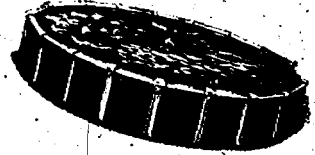

Swimming  
Pools

*Spa-Ciser* by *Curtis*

**Enjoy Christmas Eve**  
in your own  
SPA or HOT TUB

**SPAS STARTING AT \$995<sup>00</sup>**  
Complete & Installed

**CALL NOW**  
**454-3500**  
**454-3510**

**ROOM  
ADDITIONS**  
Custom Built  
Kitchen  
Cabinets

**REMODELING**  
Roofing  
&  
Siding  
Wood  
Decks



SPA Extended Warranties  
Available from  
**Spa Protection of America**

**Our Showroom Now Open**

(Pardon Our Dust)

**865 Wing St., Plymouth**  
Mon.-Fri. 8-5, Sat. 9-6

**Licensed & Insured**



PLUS



# Happy Holidays Plymouth-Canton!

It seems barely possible, but yet another year has gone by. Indeed, Christmas is just around the corner and the impact of the upcoming holiday season is already spreading throughout The Plymouth-Canton Community.

During the coming weeks a wide variety of groups and organizations (and even individuals) within the community will begin activities to spread the holiday cheer.

Plymouth will begin its holiday celebration with the coming of Santa and a tree lighting ceremony on Friday (Nov. 25) in Kellogg Park. Santa will be on hand to chat with youngsters and there will be plenty of Christmas carolling.

In Canton, the holiday season will kick off on Monday, Dec. 5 with a traditional lighting of the trees and carolling at the Canton Administration Building on Canton Center Road.

There are plenty of other events in our community as well — events with which to have some fun, or activities designed to help those less fortunate.

So, enjoy the holidays. They are a time to celebrate and a time to give and share.

THE COMMUNITY CRIER

## A Goodfellow....

Plymouth, and Canton, Goodfellows will be on the streets selling their annual Goodfellows newspapers on Saturday, Dec. 3. Here, some of the Plymouth volunteers gather for a pre-holiday photo. (Crier photo)

## Inside

- Plymouth glassblower makes special ornaments
- Here comes Santa Claus
- Salvation Army offers 'Love' baskets
- Holidays with other cultures

## About our cover

The cover and front page renderings were created by Lynn Svoboda, a former Crier/COMMA, intern from Iowa. Svoboda's work was done using multi-color paper cutouts. The scene depicts the changing of seasons and coming of the holidays. The prose poem on the cover was written by Ken Voyles, The Crier's managing editor. He attempted to reconcile both secular and religious aspects of the holiday season.

Firestone

PILGRIM  
AUTOMOTIVE

### Remember last winter?

Don't get caught in the cold this year.

Get Your  
**SNOWTIRES!**

or All Season  
Steel Belted  
Radial Tires



LOW EVERYDAY PRICE: \$28.95  
NEW! \$32.95  
CALL: 413-36-8488  
SALES: 225-75-9115

Certified Master  
Mechanics on duty  
for all general repairs

<p><b>BRAKES</b> MOST CARS FRONT OR REAR <b>\$59<sup>95</sup></b></p> <ul style="list-style-type: none"> <li>• Install Pads or Shoes</li> <li>• Resurface Rotors or Drums</li> <li>• Semi-Metallic Extra</li> </ul> <p><small>Expires 1-31-89</small></p>	<p><b>TUNE-UP</b> Most Cars With 6000 Mile Warranty <b>\$39<sup>00</sup></b></p> <p><small>Expires 1-31-89</small></p>	<p><b>WHEEL ALIGNMENT</b> MOST CARS <b>\$24<sup>95</sup></b></p> <ul style="list-style-type: none"> <li>• Inspect Tires</li> <li>• Check Air Pressure</li> <li>• Adjust Toe</li> </ul> <p><small>Expires 1-31-89</small></p>
<p><b>RADIATOR FLUSH &amp; FILL</b> <b>\$24<sup>95</sup></b></p> <p><small>Includes 1 Gal. of Anti-Freeze Belts &amp; Hoses Checked Expires 1-31-89</small></p>	<p style="text-align: center;">OFFICIAL TESTING STATION <b>AET</b> <b>\$7<sup>90</sup></b></p> <p><small>Expires 1-31-89</small></p>	<p><b>LUBE, OIL &amp; FILTER</b> MOST CARS <b>\$15<sup>95</sup></b></p> <ul style="list-style-type: none"> <li>• New Oil Filter</li> <li>• Complete Chassis Lube</li> <li>• Up to 5 Qts. 10W30</li> </ul> <p><small>Expires 1-31-89</small></p>

**BATTERIES**  
**10% OFF**

Expires 1-31-89

1 PER PURCHASE

1 PER PURCHASE

**OPEN SUN 10-3**  
Mon. & Thurs. 8-8  
Tue., Wed., Fri., Sat. 8-6

**453-3900**

280 W. Ann Arbor Rd.  
Plymouth, MI

# Take a Christmas walk through Old Village

Plymouth's historic Old Village will be the scene of the annual Christmas Walk on Sunday (Nov. 27) from noon to 6 p.m.

Walkers will get a chance to meet merchants who will welcome them with a hot drink or a holiday cookie. They can meet dollmakers who create old fashioned dolls of porcelain and cloth, or dressmakers, or even those all important candymakers.

Most of the Old Village shops, including the eight antique shops, will be open for those looking for that special holiday gift.

Many of the shops in the quaint section of Plymouth are housed in 1870s storefronts and 1890s farmhouses. There's also an old bank, a refurbished railroad depot, a 1916 Buick garage, a remodeled greenhouse and the church where Carrie Nation preached.

Santa Claus will also be on hand that day and there will be a pony wagon for the kiddies.

Carolers will be on hand to entertain walkers and the city's double-decker bus will run at regular intervals between Old Village and downtown until 5 p.m.



Michael Bell (left) and Kristi Bell get a look at Santa Claus during the annual Old Village Christmas walk. This year it's slated for Sunday (Nov. 27). (Crier photo)

Breakfast at **Silverman's**

Then off to Grandma's House

OPEN Thanksgiving Day

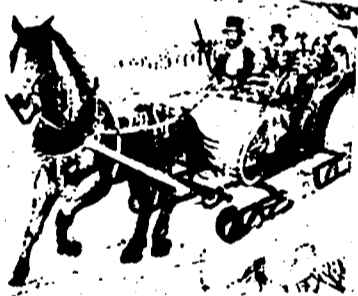

All Specials served with toast, biscuits, bagel or muffins. Includes American fries or hash browns (except) #s 2, 5, 11 & 15

**SAMPLER** 2 or 3 eggs, 1 sausage, 1 bacon, 1/2 slice ham, hash browns, American fries or pancakes and your choice of 1 biscuit, 1 blueberry muffin or toast. Served until 3 p.m. daily 2.95

- #1 Two eggs, any style... 2.25
- #2 One egg, any style, two pancakes, two sausage links or two bacon... 2.80
- #3 Two eggs, any style with 4 sausage links or bacon... 3.05
- #4 Two eggs, any style with ham steak... 3.40
- #5 Homemade sausage gravy with biscuits, toast or bagel... 2.80
- #6 Mini corned beef hash, a fresh combination of onions, peppers & hash browns with two eggs... 3.55

#7 Two egg omelette with sharp Cheddar cheese and ham... 3.15

#8 Two egg omelette with mushrooms and Swiss cheese... 3.15

#9 Two egg omelette with sharp Cheddar cheese & broccoli... 3.15

#10 Mini "Porky" ham, sausage, bacon & American cheese... 3.25

#11 Potato pancakes (4) with sour cream & apple sauce 2.95

#12 Mini Denver with sharp Cheddar cheese, ham, onion & green peppers... 3.25

#13 Two egg omelette with Spam & old fashioned American cheese... 3.25

#14 Two eggs with (3) smokey links... 3.05

#15 Raisin French toast topped with powdered sugar. Served with 2 strips of bacon or 2 sausage links... 3.50

S. Main St. at Ann Arbor Rd., Plymouth 459-2066

**YES!** we are opening at South Lyon in early December.

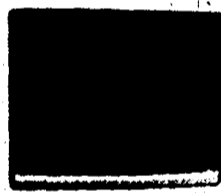

**Monitors**  
TTL — Green or Amber Screen  
Values to \$129.00 **NOW \$84.50**

**PRINTERS**

PANASONIC — 1080 i, JL  
cable included **NOW \$189.95**

PANASONIC — 1524  
wide carriage 24 Pin **\$629.00**  
(one only)

KAYPRO AT — Floor Model  
10 MR - 768K - 1.2 Meg Floppy DD  
MS Dos 3.2 **NOW \$995.00**

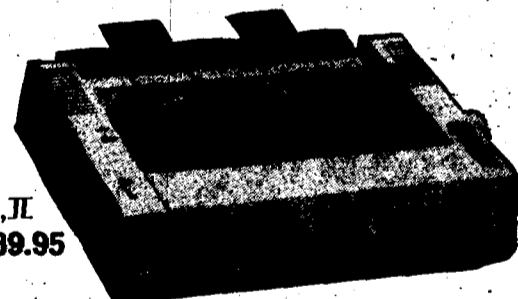

FORTIS Dual Head Printer  
Daisy Wheel or Dot Matrix  
Wide Carriage **NOW \$729.00**

**FRANKLIN COMPUTER**  
512K — Double Disk Drive  
Green Screen Monitor  
Dos and GW Basic **NOW \$695.00**

**10% Discount on Computer Accessories and Peripheral Hardware.**



770 Penniman • Plymouth • 453-2202

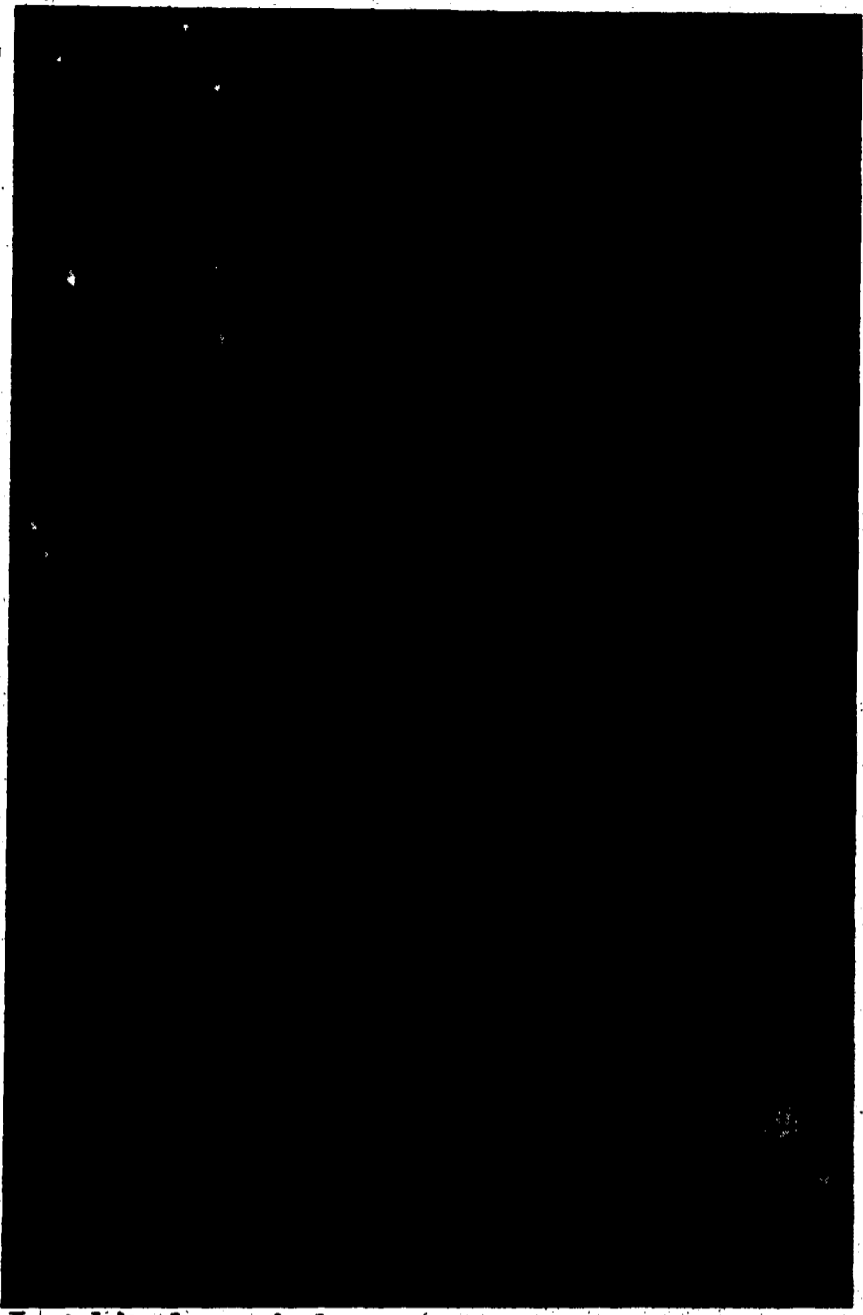

*Just hit the switch*

While the Christmas tree glows in the background, residents of Plymouth gather to sing holiday carols and enjoy the spirit of the season. (Crier photo)

*Santa is coming to town*

It's almost here.

Friday (Nov. 25) is the big day in the City of Plymouth.

On that day Santa Claus will come to downtown Plymouth and residents can join the Annual Tree Lighting and Caroling Ceremony at 6 p.m. in the bandshell in Kellogg Park.

Santa will be on hand to lead the carolers, along with members of the Plymouth Community Chorus and the nationally honored Centennial Educational Park (CEP) Marching Band.

Santa will also be in his "house" in Kellogg Park from 6:30-8 p.m. that night visiting with children who may have a Christmas wish or two.

Santa will arrive in an antique fire truck on Friday just before the main ceremony. Local government officials will help him light up the community Christmas tree.

The Salvation Army will also be on hand for the ceremony with a truck to pick up any canned goods, toys or clothing residents wish to donate to their annual holiday drive to help the needy of the community.

Members of the CEP Marching Band will perform that evening, after which they will be seeking small donations to help fund their trip to the Orange Bowl this year. For a donation a resident will receive an Orange Bowl decal.

Many downtown merchants will provide holiday cordials that evening, said Mary Roehr, of the Plymouth Community Chamber of Commerce, the main organizer of the annual events.

There will be no Giving Thanks Parade this year.

**Take Care Of Your Fine Feathered Friends at SAXTONS.**

We Have the Largest Selection of Bird Feeders in the Area.  
You Buy the Feeder, We Supply Bird Feed

**For Every Dollar Spent On Feeder, We Will GIVE You One Pound of Bird Feed**

MUST BRING AD TO SAVE DOLLARS

Serving You Since 1928

**SAXTONS**  
GARDEN CENTER INCORPORATED  
587 W. Ann Arbor Tr. • 453-6250 • Plymouth

Mon. - Fri. 9-6  
Sat. 9-3

THE CRIER PLUS: 1968 Home for the Holidays

**PLYMOUTH NURSERY**  
*Christmas in the Country*

Take a Drive in the Country and Experience Christmas Like You Remember It!

Visit our beautiful Christmas display and make it a family event.

**Fresh-Cut Trees** Over 2,000 Trees to choose from! 3' to 18'. Select from the FRESHEST trees in town! Our buyers have searched the United States and Canada to bring you the finest trees available. Select from: Scotch Pine, White Pine, Blue Spruce, White Spruce, Fraser Fir, Douglas Fir, Balsam Fir, and Concolor Fir. We also Custom Flock trees!

**BONUS COUPON**  
**FREE**  
**TREE CARE KIT**  
**\$4.00 VALUE**

With purchase of 5' or larger Fresh Cut Tree includes one bottle of Tree Preservative and Giant Disposal Bag. Not good with any other cut tree offer.

**PLYMOUTH NURSERY COUPON**  
EXPIRES DEC. 18, 1968

Join Us In These Exciting Events!

**FREE** - Cider & Doughnuts, Hay Rides, and Camp Fires

Pictures with Santa in his workshop for only \$1!

**Wreath Special**  
20" Plush Balsam Wreath  
**\$6.95**  
Reg. 9.95  
While 400 Last

Expires 11-28-68  
Item # 6139-028

**Michigan Cedar Roping**  
Extra Heavy Grade  
60' Coil  
**\$24.95** Reg. 29.95  
While 200 Last • Expires 11-28-68  
Item # 6139-003

**PLYMOUTH NURSERY**  
*Christmas in the Country*

Hours: Mon-Sat 9-8  
Sun. 10-6  
453-5500

9900 Ann Arbor / Plymouth Road • 7 miles West of I-275

For local kids

## Plymouth barber makes holidays golden

BY KEN VOYLES

Nearly nine years ago Mel Bobcean was entertaining a group of handicapped children as a clown. When he got ready to leave, the youngsters held on to him for dear life.

"They didn't want me to go," said Bobcean, owner of Mel's Golden Razor at 595 Forest in the City of Plymouth. "That's when I asked them what else I could do to help. They said they could always use toys."

That was the beginning of what has become a yearly tradition for the popular haircutter. Ever since then every year Bobcean has collected new and used toys to give to needy and abused children, handicapped children, and needy families.

It is a task Bobcean cares deeply about.

"I do it mainly because of that first incident," he said. "It made me feel sad to leave there."

Bobcean, who likes to get out and make house calls to cut the hair of handicapped residents, said he has been attuned to the sufferings of others because his own wife Nancy has M.S., multiple sclerosis, a degenerative disease of the central nervous system.

This year Bobcean's 9th Annual Toy Collection starts on Nov. 25 and runs through Dec. 17. He will accept new and used toys of all shapes and sizes, from dolls to bicycles, from stuffed animals to games.

Mel's is open from 8:30 a.m. to 6 p.m. on Tuesday through Saturday. Those who wish to help can stop by with their toys or give Bobcean a call at 455-9057.

Last year Bobcean gathered nearly 4,000 toys thanks in part to several local Boy Scout and Girl Scout troops as well as students in The Plymouth-Canton Community Schools and even senior citizens.

"The seniors surprise me," Bobcean said. "They don't have much themselves, but yet they go out and get toys."



### Gifts from Mel

Mel Bobcean, over at Mel's Golden Razor in the city, has been helping kids for more than eight years by collecting new and used toys. Call Mel if you want to help. (Crier photo)

## Dickens comes to life

Charles Dickens' "A Christmas Carol" will be read by Bert Hornbeck, professor of English Literature at the University of Michigan, on Friday, Dec. 2 at the First Presbyterian Church in Plymouth.

The 7:30 p.m. reading is scheduled to last approximately 45 minutes. Tickets are \$3.

For further information call 453-6464.

## Christmas art for sale

The Three Cities Art Club will be hosting its Christmas Art Show and Sale at the Charlestown Square Mall Gallery in the City of Plymouth on Saturday and Sunday (Nov. 26-27) from 10 a.m. to 5 p.m.

Various works by club members will be on display, including oil paintings, watercolors, acrylics and others.

Refreshments will be served.

For further information call Kay Fill at 455-5805.

Among the artists represented will include Yolanda Menchaca, Janice Sparks, Betty Mathey, Florence Hirschman and Judy Gillis.

GRUNWALD'S  
*House of Fudge*  
& Fine Handmade Confections



### Visions of Sugarplums and Christmas Eve Dreams ...

- Unique Holiday Tins
- Dessert Trays
- Hostess-Gifts
- Custom Filled for Business & Personal Gift Giving

Scrumptious Hand-Made

- Chocolates
- Truffles
- Fudge
- Nut Brittles
- Sugarless Chocolates

*We mail anywhere in the U.S.!*  
13 Forest Place (across from Cozy Cafe) • Plymouth • 459-1990  
Holiday Hours: M-F 10-9, Sat. 10-6, Sun. 11-4

**ENTER THE PLYMOUTH-CANTON  
COMMUNITY CRIER'S  
9th ANNUAL  
HOLIDAY COLORING CONTEST**

THE CRIER PLUS: 1988 Home for the Holidays



Here's your chance to win a  
**\$40 Gift Certificate!**

**RULES:** To the best of your ability color the picture and write a special holiday wish in 30 words or less. Entries will be judged on originality.

A \$20 Gift Certificate will be awarded to each winner in each category. A \$40 Gift Certificate will be awarded to the Grand Prize Winner.

Certificates may be redeemed at any advertiser in the Dec. 14 Letters to Santa Section of The Community Crier.

Winners will be pictured with their winning entry in the Dec. 14 issue of The Crier.

The Grand Prize Winner will have his/her entry printed in **FULL COLOR** as the front cover of the Dec. 14 Dear Santa issue.

Letters to Santa will be printed (space permitting) in the Dear Santa section.

One entry per person.

Contest closed to Crier employees, their families and relatives.

Hurry and mail your entry today! You could win a \$40 gift certificate. The decisions of the judges will be final. Entries cannot be returned.

Write a Letter to Santa IN 30 WORDS OR LESS

**Dear Santa:**

---



---



---



---



---



---



---



---

**PLEASE FILL OUT the following.  
Entry void if not filled out completely.**

**NAME** \_\_\_\_\_

**ADDRESS** \_\_\_\_\_

**CITY** \_\_\_\_\_ **PHONE** \_\_\_\_\_

**CHECK ONE:**

Pre-School - Grade 1;  Grade 2, 3 & 4;  Grade 5-8

**DEADLINE is  
Friday, Dec. 2  
5 p.m. (SHARP)**

Bring or Mail Entry to:  
The Community Crier  
821 Penniman Ave.  
Plymouth, MI 48170  
Hours: Mon.-Fri. 9-5

With a little help from its friends

# Salvation Army spreads 'Love'

BY PAUL GARGARO

Perhaps more than any other time of the year, the holiday season is wrought with symbols.

Brightly lit trees, candles in windows, wreaths, bells, the jolly fat man in red, the menorah, and the creche, are but a few of the many familiar signs that we associate with the holidays and the New Year.

On street corners in cities across America, over the years Salvation Army has added another symbol to the season.

Beginning in November and running through Christmas Eve, residents in The Plymouth-Canton Community will see the familiar fundraisers toting their red kettles.

The kettles are staffed by Salvation Army officers, local service clubs, and a number of volunteers, said Plymouth Salvation Army spokesperson Heather Doughty.

Proceeds from the collection will go to support the Salvation Army's operating budget.

In addition the Red Kettle drive, the Salvation Army is also coordinating a food drive as part of their "Sharing is Caring Christmas" theme.

With this theme, in mind Omnicom Cablevision in Canton, in cooperation with the Plymouth and Canton chambers of commerce, will once again be lending their support to the Salvation Army's "Baskets Filled with Love" food collection drive for the needy.

Started on Nov. 7, "Baskets Filled with Love" calls on people's spirit of sharing to donate canned goods to be delivered to those in need through the community.

The project will culminate with a Dec. 10 live telethon on that Saturday at the Omnicom studio.

Churches businesses and schools are asked to participate in the drive by gathering foodstuffs in "Love Boxes" and displaying "Love Posters," both provided by the Salvation Army and can be obtained by call 453-5464.

Participating collectors, like the Centennial Education Park (CEP) students' Executive Forum, are invited to appear on the Omnicom Telethon and share the secrets of their success with the viewing audience.

The telethon is scheduled to begin at 2 p.m. and will be shown on Omnicom Channel 15.



Sara Broschay (left), a Canton junior and Jill Estey, a Salem senior, collect canned goods for the Salvation Army's "Basket filled with Love" campaign. Students from both schools, led by the CEP Executive Forums, hope to collect more than 3,000 cans this year. The drive lasts until Dec. 10. (Crier photo by Chris Farina)



*Three generations of the Schrader family have lived and worked in the Plymouth-Canton Community.*

*We are proud to have served your needs for over 84 years.*

*We wish all our friends and neighbors a Happy Thanksgiving and a very Merry Christmas.*



Fred D. Schrader  
Founder



Edwin A. Schrader  
Director

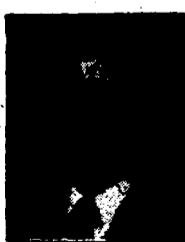

Edwin A. Schrader, Jr.  
President

**Schrader Funeral Home**

**The Schrader Family**

Funeral Directors in Plymouth Since 1904  
280 South Main Street • Plymouth, MI 48170 • 453-3333

## Enter decorating contest

Nominations for the 2nd Annual Holiday Home Decorating Contest in Canton will be accept by the Beautification Committee from Dec. 1-14.

Award winners will be announced the week of Dec. 19.

Nominations should be sent to Eileen Wojcik, chairperson, Holiday Home Decorating Contest, 44666 Twyckingham, Canton, MI 48187.



### On sale now

This is a scene of Penniman Avenue in Plymouth during the holidays. It is this year's greeting card sponsored by the Plymouth Community Arts Council.

## PCAC cards portray a Plymouth Christmas

The Plymouth Community Arts Council (PCAC) holiday greeting card -- "Christmas on Penniman Avenue" -- may be purchased at the PCAC office at 332 S. Main St.

A package of 25 cards and envelopes is being sold for \$10. Call the PCAC at 455-5260 for details.

The cards will be sold at the following Plymouth locations:

Me and Mr. Jones, The Petite Shop, Armbruster's Bootery, Frameworks, Main Street Hair Company, Sacks of Forest Place, The Corner Curtain Shop, Good's Nursery, Plymouth Orchard, Office of Council on Aging, Mayflower Hair-Design, Wild Wings, PCAC Art Rental Gallery in Dunning-Hough Library, Shear Image, Roadhouse on Joy and B.J. Corey's Hair Design.

Money from the cards will be used to fund programs sponsored by the PCAC.

## It's a Holiday Ball

The Plymouth Symphony League will celebrate a "Christmas Homecoming," with its annual Christmas Ball on Saturday, Dec. 3 at the Mayflower Meeting House.

Tickets are available at Sacks on Forest Avenue. They are \$65 per couple and include dinner, live music and dancing. Dinner will be served at 7:30 p.m. with a cocktail hour proceeding at 6:30 p.m.

The public is invited.

This will be the first year that the ball has been held in Plymouth in several years, according to one league member.

## Stores extend holiday hours

Most of the stores in downtown Plymouth will have extended hours during the holiday season, according to Mary Roehr, of the Plymouth Community Chamber of Commerce.

Store hours on Monday through Friday are from 10 a.m. to 9 p.m., said Roehr, while Saturday hours are from 10 a.m. to 6 p.m.

On Sunday, stores will remain open from noon to 5 p.m.

## Giving Thanks Parade runs out of steam

There won't be a Giving Thanks Day Parade to celebrate the coming of the holidays in the City of Plymouth this year, according to Mary Roehr, executive director of the Plymouth Community Chamber of Commerce.

The parade, which was resurrected several years ago, has been cancelled this year, said Roehr, primarily because of the expense and the difficulty of getting participants and sponsors.

"The timing isn't the best either," Roehr said. "It's hard to get volunteer groups to come out and the parade takes a lot of volunteer energy."

Traditionally the parade has been held in downtown streets on the day after Thanksgiving, usually along with a variety of other events.

Roehr also noted that there has been a difference of opinion on the worth of a parade by local business owners. "Some think it's great and others think it's not so great," she said.

As for the public Roehr said, "I guess I've heard mixed reviews." She said the original intent was to offer residents a small holiday parade, and that it was never intended to be on a large scale, like the parade held in Detroit.

The parade may be cancelled, but other holiday events will still be held, said Roehr, including the tree lighting ceremony in Kellogg Park. The chamber will also be working to collect canned goods for the Salvation Army this year.

### Santa Has Time To Relax Because He Owns A TORO

America's most popular Snowblower at a More popular price.

NOW \$349<sup>95</sup>

\$349<sup>95</sup> manual

Haven't you done without a Toro long enough?



TORO

Serving You Since 1928

# SAXTONS

Garden Center Incorporated  
587 W. Ann Arbor Tr. • Plymouth

Mon.-Fri. 9-6  
Sat. 9-3

453-6250



*Santa visits, eats, lights trees, etc.*

# A Canton Christmas collection

BY RITA DERBIN

The season of giving and good wishes is upon us. The weather is chilly, with a smattering of snow in the air. Children are dreaming of what Santa will be bringing them next month and adults are wondering where the year went.

And what is Canton doing to prepare for the holidays?

Well, Santa Claus will be arriving and trees will be lit, and the community will be filled with a sense of charity.

Santa is coming to Canton on Friday (Nov. 25). He will arrive by helicopter and will be visiting with all the "good" girls and boys at the Canton Cinema between 9-11 a.m. Children will be able to visit with Santa, and the first 500 arrivals will be able to view a Christmas movie in the cinema.

The Canton Chamber of Commerce is sponsoring Santa's visit and all participating children will receive a free goody bag and their parents will receive a free valuepack book. Refreshments of hot chocolate and orange drink will be donated by McDonalds of Canton and donuts and cookies will be donated by various businesses.

Santa will not be forgetting the older "kids" in Canton either. He will make an appearance at the St. Nick's Frolic Luncheon sponsored by the Canton Senior Citizens Department on Wednesday, Dec. 7. The luncheon will be held at Fellows Creek Golf Course from noon to 4 p.m. The price of admission is \$7.50 per Canton resident and \$10.50 for non-residents.

At the luncheon, Christmas ornaments that are being made by seniors for the Christmas tree at the Ronald McDonald House in Ann Arbor will be judged by Nora Pawlus and prizes will be awarded to all participants.

The price of admission includes a buffet luncheon, entertainment, prizes and a visit from St. Nick (Santa) himself.

Tickets must be purchased by Friday, Dec. 2. For more information call the Senior Citizens Office at 397-1000 ext. 278.

McDonalds will also be holding its Breakfast with Santa from 9-11 a.m. on Dec. 10 at the Michigan Avenue location and Dec. 17 at the Ford Road site.

Santa will be sitting in the lobbies of the McDonalds' giving out presents to all the children 12 and under and reading Christmas stories. A giant stocking filled with prizes will also be given out.

Santa will also be making the rounds at the Childrens Christmas party at the Canton Recreation Center on Dec. 10. Treats and a Christmas movie will be provided free of charge. From 9:30-10:30 a.m. Santa will visit with children 3-7 years old, and from 10:45-11:45 he will be with children 12 years and under.

The party is sponsored by the Canton Parks and Recreation Department. The Recreation Hall is located on Michigan Avenue and Sheldon Road.

Santa will also make an appearance when the township holds its annual tree lighting ceremony on Monday, Dec. 5 at 7 p.m. The event will be held at the Administration Building located at 1150 S. Canton Center Rd.

Along with the tree lighting there will be free refreshments, Christmas carolling and entertainment by the Seniors Kitchen Band.

A free Christmas stuffed animal raffle will also be held for children 12 and under.

There are several other activities being held throughout the holiday season in Canton.

Once again the Salvation Army will provide needy families with toys and food at Christmas time. Families are now being registered for holiday baskets and donations of new toys and Christmas items are needed. They can be dropped off at 9451 South Main by Dec. 16 but food is welcome all year round.

The Salvation Army will also be sponsoring a free Christmas dinner for senior citizen on Dec. 5 at 6 p.m. Turkey and all the trimmings will be served to the first 150 seniors to make reservations at 453-5464.

Salvation Army Santas with Christmas kettles will also be found throughout Canton from just after Thanksgiving through Christmas Eve.

Omnicom Cablevision is sponsoring a Baskets Filled with Love Food Drive/Telethon for the Salvation Army with both the Canton and Plymouth Chambers of Commerce.

*He's b-a-c-k!!*

Canton residents go wild for Santa as he makes his annual stop in the township. There are plenty of other holiday events in Canton as well this year. (Crier photo)





## Canton kicks in to spread cheer

The food drive kicked off Nov. 7 and the community is urged to contribute canned goods throughout the holiday season. Local businesses, churches, organizations and schools are participating in the drive. If anyone is interested in participating call Omnicom at 459-7335 or the Salvation Army 453-5464.

The fifth annual telethon is Saturday Dec. 10 from 2-9 p.m. on cable channel 15. It will be a live cable program on encouraging people to collect canned goods for the Salvation Army.

Numerous local radio, television and sports celebrities and business leaders will be on the air making cash donations at that time and donations from the community will be possible at that time.

An auction will also take place during the telethon with all proceeds going to the Salvation Army.

Omnicom is also sponsoring a "Love" page coloring contest for children with over 200 prizes to give away.

Children can pick up their "Love" page at Omnicom Cable at 8465 Ronda Drive or pick them up at local businesses.

Omnicom and all the cable operators in southeast Michigan are participating in Cable Caring for Kids. The program is offering any subscribers who donates \$10 to the Childrens Hospital of Detroit a free pay channel service.

The Canton Chamber of Commerce Christmas party will be Dec. 7 at Fellows Creek Golf Course with hors d'oeuvres and a cash bar. The cost for a ticket will be \$7 plus a canned good. An extra dollar will be charged without a canned good.

The Lions Club is sponsoring its annual candy cane sales throughout Canton on Dec. 2-3 and Dec. 9-10. The candy canes filled with chocolate candies cost \$1 and proceeds will go towards all events sponsored by the Lions throughout the coming year.

The Lions will also be helping the Canton Goodfellows sell their holiday newspapers at intersections throughout Canton on Saturday, Dec. 3. They are looking for volunteers and any interested can call Lt. Larry Stewart at 397-3000. Lunch and coffee will be provided for all volunteers.

Finally, Canton Parks and Recreation will be sponsoring the fourth annual "Guaranteed White Christmas" contest in case of no snow.

The winner will be drawn on Monday, Dec. 19 and snow will be spread on Dec. 20 if nature does not cooperate with the holiday spirit.

Entry forms are available at all schools, the recreation department and the reception area of the Administration Building. Entries can also be mailed in with the entrants name, address and phone number to Canton Parks and Recreation Guaranteed White Christmas, 1150 S. Canton Center Rd. 48188.

## Christmas shopping for kids

This one is just for kids.

The Children's Christmas Shopping Boutique, open to young Plymouth buyers, will be open on Dec. 11 from 10 a.m. to 1 p.m. at the Mayflower Meeting House.

The boutique features merchandise for the children to buy as Christmas gifts. High school students from the National Honor Society will escort each child through the shopping area.

Gift items will range in price from 25 cents to \$5.

There is no charge to participate in the event. Merchants will reserve tables through the Plymouth Chamber of Commerce and feature a wide range of gifts.

For further details call the chamber office at 453-1540.



Santa arrives in Canton with a little help from the township's fire department. He arrives this year on Monday, Dec. 5. (Crier photo)

## Thank You!

As we celebrate our 25th anniversary, we wish to thank our clients, suppliers and friends who have helped make our success a mutual achievement.

Most importantly, we thank our employees — the team of dedicated, energetic people who make our accomplishments possible!

Joe Tate - President  
Beverlee McAllister - Vice President  
George Osterhout - General Manager



PARTNERS FOR PROGRESS  
1963 - 1988

# SPECIAL HOLIDAY SHOPPING HOURS AT YOUR

Shop Early!

**O & B Bookery, Inc.**  
481 W. Main Street Trail  
455-3420  
Extended business hours, open Sundays  
in Chatham

**Walker's Book**  
588 Forest Ave. - Plymouth  
483-1788  
7:00 am - 6:00 pm Sat.  
7:00 am - 5:00 pm Sun.

**Country Cupboard**  
535 Forest Avenue - Plymouth  
455-6696  
10:00 am - 9:00 pm Mon. - Fri.  
10:00 am - 6:00 pm Sat.  
12:00 - 5:00 pm Sun.

**Amherster Bakery**  
348 S. Main - Plymouth  
455-7818  
10:00 am - 9:00 pm Mon. - Fri.  
10:00 am - 6:00 pm Sat.  
12:00 - 5:00 pm Sun.

**Real Image Gallery**  
575 W. Main Arter Trail  
455-2488  
10:00 am - 5:00 pm Mon. - Fri.  
10:00 am - 6:00 pm Sat.  
12:00 - 5:00 pm Sun.

**Pat's Soap's & Candles**  
Wool's, Weymouth's & Candles  
322 S. Main - Plymouth  
455-6655  
9:30 am - 6:00 pm Sat.  
9:30 am - 5:00 pm Sun.

**Sandy's Fashion & Hair Accessories**  
Cosmetics  
608 S. Main - Plymouth  
455-2131  
10:00 am - 6:00 pm Thurs. - Fri.  
10:00 am - 6:00 pm Sat.  
10:00 am - 5:00 pm Sun.

**Quaker's Place**  
1318 Main Arter Rd. - Plymouth  
455-4406  
9:00 am - 7:00 pm Mon. - Fri.  
9:00 am - 6:00 pm Sat.  
9:00 am - 5:00 pm Thurs. - Fri.  
9:00 am - 4:00 pm Mon. - Thurs. Eve.

**Engraving Connection**  
530 W. Main Arter Trail - Plymouth  
459-3188  
10:00 am - 9:00 pm Mon. - Fri.  
10:00 am - 6:00 pm Sat.  
12:00 - 5:00 pm Sun.

**Larson's & Sons & Phil Houspar**  
122 Forest Ave. - Plymouth  
455-3418  
10:00 am - 9:00 pm Mon. - Fri.  
10:00 am - 6:00 pm Sat.  
12:00 - 5:00 pm Sun.

**Armed Air**  
588 W. Main Arter Trail - Plymouth  
455-8818  
10:00 am - 9:00 pm Mon. - Fri.  
10:00 am - 6:00 pm Sat.  
12:00 - 5:00 pm Sun.

**Paul & Eric's**  
582 W. Main Arter Trail - Plymouth  
453-4888  
10:00 am - 9:00 pm Mon. - Fri.  
10:00 am - 6:00 pm Sat.  
10:00 - 5:00 pm Sun.

**Woods Hardware & Farm Supply**  
478 Forest Ave. - Plymouth  
455-3418  
10:00 am - 6:00 pm Mon. - Fri.  
10:00 am - 6:00 pm Sat.  
12:00 - 5:00 pm Sun.

**Wool's & Sons**  
582 W. Main Arter Trail - Plymouth  
453-4888  
10:00 am - 9:00 pm Mon. - Fri.  
10:00 am - 6:00 pm Sat.  
10:00 - 5:00 pm Sun.

# THE FINEST STONES



# Merry Christmas!

from

Plymouth's Historic

## Old Village

Come Enjoy a Place Where the Spirit of  
Christmas Past Still Exists

**17th Annual Christmas Walk**  
**Sunday, November 27, Noon till 6pm**

Find something for Everyone on your list while  
you walk on the cobblestones & visit the shops in the  
1890's farmhouses. We offer you personal attention,  
warm Holiday Refreshments, Carolers, Horse-Drawn  
Carriage Rides, and the Children can visit  
Santa & have a Photo taken.

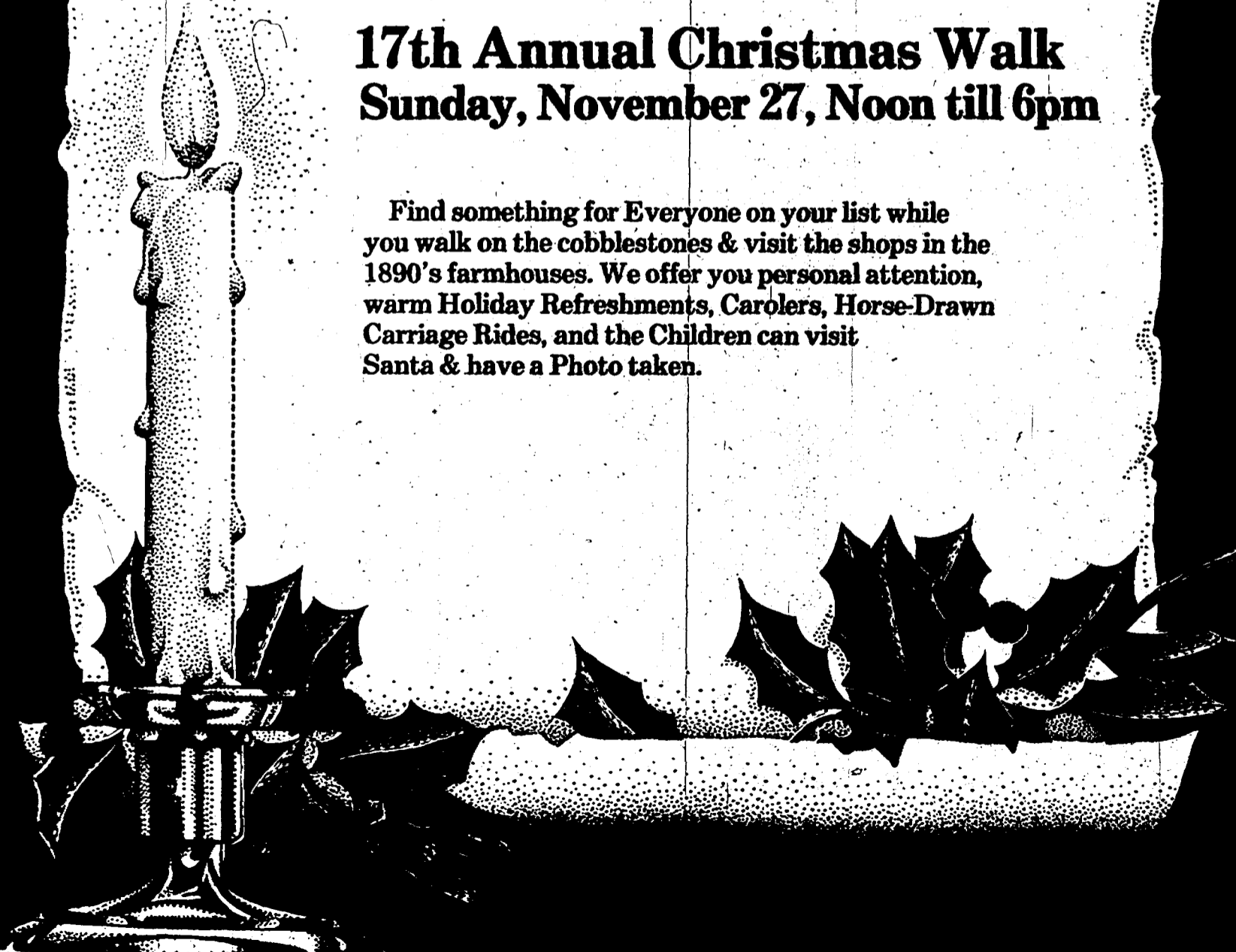

# ONE CALL DOES IT ALL

We offer a complete cleaning package to accommodate even the most modest budget.

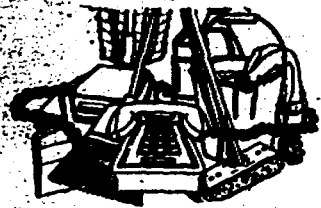

We'll clean carpets, furniture, floors, or your entire house!  
Residential • Commercial

**ServicEMASTER.**



**459-8330**



If you're tired of "Ill Fitting" Clothes call

## The VILLAGE TAILOR

### ALTERATIONS

- monogramming
- mens, womens & childrens
- slacks hemmed While-U-Wait
- skirts & dresses hemmed

**451-7820**

10-6 Tues. • Wed. • Thurs.  
9-5 Fri. 9-3 Sat.  
Closed Mondays

696 Mill St.  
Olde Village Square  
Plymouth, MI

FINE PASTRIES FOR DISCRIMINATING TASTES

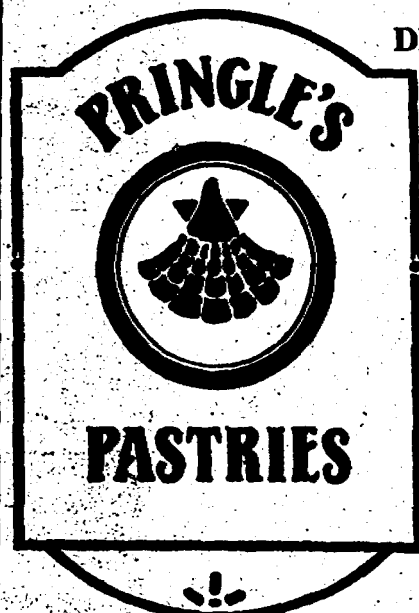

Specializing In  
Chocolate Tortes  
& Cheesecakes

Please place order 2 days in advance because of time involved in preparing these fine pastries.

795 N. Mill — Plymouth — 453-4226  
Mon-Sat. 9:30 am to 6 pm Closed Sundays

## Holiday Wishes Can Come True ....

THANKSGIVING CHRISTMAS NEW YEARS

Lose 10 to 29 Pounds Permanently  
First 25 People ...

We'll pay you to lose up to 29 pounds in the next 30 days

**A Complete Weight Control Program**  
Featuring the Amazing of Natural Herbs.

- 100% Natural
- 100% Guaranteed
- Doctor Recommended
- No Weighing Food
- No Drugs
- No Daily Visits

PLY-CANTON-NORTHVILLE  
453-2970/453-7802

DEARBORN 563-5528  
ROMULUS/HURON TWP. 782-1617

REDFORD/N. LIVONIA 531-2766  
LIVONIA 427-2877/422-0412



Just outside Aspen, Colorado, in 1972, two 21 year old girls opened a cubbyhole shop featuring quality handmade clothing. Both were very talented but without capital. They designed their clothing out of old curtains, antique doilies, denim and occasionally, new fabric which friends donated. Thus the name Mountain Rags came to be the title of their new adventure.

Over the years Mountain Rags has flourished and found its way to Plymouth, Michigan. But one thing that will never change is our name, and our commitment to Quality versus Quantity.

Since you are the reason for our continued success we would like to invite you to join us this Holiday Season. Bring this ad with you and we will gladly give you 25% holiday discount on any purchase you may select now until December 25, excluding sale items.



643 N. Mill St.  
Old Village  
Plymouth, MI 48170

(313) 451-0808

# Historic

## A YESTERYEAR CHRISTMAS



**Celebrate the tradition.**

Are you tired of bouncing off the Wall shopping at the Mall?

Plymouth Historic Old Village

invites you to shop with US before you head out to the MALLS?

Over 50 quaint unique shops, featuring Hand-made and Original Merchandise. Never to be found elsewhere.

**Plymouth Historic Old Village**

1 1/4 mile Northeast of Downtown Plymouth

## Two ways to ring in the holiday spirit.



Just call or visit us today to send the FTD® Brass 'n' Blooms™ Bouquet.



Or the FTD® Holiday Cheer™ Bouquet.

FTD Flowers—The feeling never ends.

Flowers by  
*Friendly Persuasions*



696 N. Mill St. • Plymouth • 453-5240

## Village Doors

*Elegant Styling  
And Uncompromised Quality  
In Premium Oak Doors and  
Sparkling Beveled Glass Inserts*

- Oak Doors • French Doors • Patio Doors

You will be pleased that we have added the complete line of Peachtree Windows and Doors.

**PEACHTREE**

All Peachtree doors can be combined with Peachtree windows to form unusually beautiful units.

744 Starkweather  
Plymouth

453-1660

Mon. - Fri. 10-5  
Sat. 12-5

## Plymouth Antiques Mini Mall

*"Make That Gift of the Future, a Treasure of the Past."*

**Visit Our Showrooms**

American, French and British Dealers

- Wardrobes • Tables
- Chairs • Cabinets
- Clocks • China

New Shipments Arrive Regularly



900 N. Mill St. • Plymouth  
455-5595



Quilts • Wall Hangings • Apron Sets • Pillows • Lace

*The Whig & The Whiffletree, Inc.*

592 N. Mill, Plymouth • 459-5057

Visit your favorite shoppe for a wonderful unique Old-fashioned Christmas Experience

**Special Holiday Treats**

- Aromatic potpourri & teas
- Original designed wreaths & Williamsburg flower arrangements
- Christmas treeskirts, Quilts & handcrafted smalls.
- 1989 Lang Calendars & Frames
- German Nutcrackers
- Old World handcarved Santas & pull toys
- Christmas candles & much, much more.



Unique Brooms

Hangers

Creative Candles

Handwoven Rugs • Tableware • Personal Throws • Bees Wax

Irons • Gourmet Tea • Great Potpourri • and Much More •

## Old Village Sausage & Deli

ENJOY THE HOLIDAYS

Let Us Do The Cooking

**ORDER EARLY**

for your

**GRANDMA KAYS HONEY BAKED SPIRAL CUT HAMS**  
and  
**HOLIDAY KIELBASA HOLIDAY PARTY TRAYS**

696 N. Mill  
In Old Village  
453-3705



Vegetable, Meat, and Party Trays

Fresh Daily Baked Goods

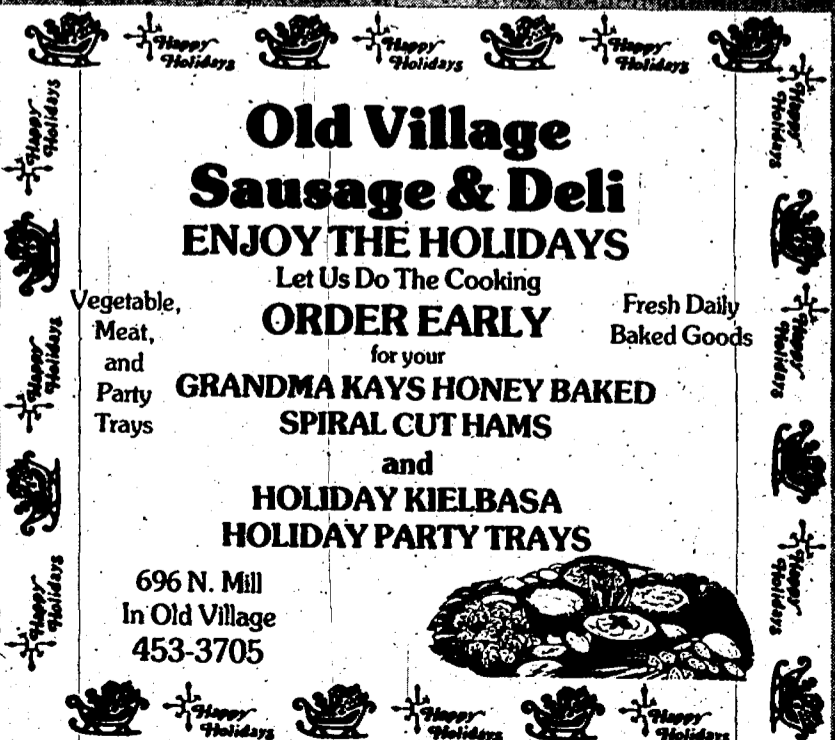

**TIMELESS ELEGANCE**  
Stereo Console Color TV

- Color TV with Remote Control  
Featuring:
- MTS Stereo Sound System
  - Computer Space Command 3000 TV/VCR Remote Control
  - Chromacolor Contrast Picture Tube
  - Programmable Channel Scan
  - 178 Channel Tuning
  - Auto-Control Color System
  - On-Screen Display
  - Sleep Timer
  - Auxiliary Jack Panel

**ZENITH 25"**  
CUSTOMER SERIES

Model SE2517P  
Classic styling.  
Pecan color finish.



**BIG J'S TV**

"Clearance Prices Throughout the Year"  
384 Starkweather • Old Village • 453-6480

Room Available for:  
Rehearsal Dinners  
Business Meetings  
Showers  
Special Events

**SUNDAY  
BREAKFAST  
SPECIALS**  
11 am - 2 pm

Enjoy Fine Food & Spirits While You Watch the Trains Go By

Mon.-Thurs 11:00 AM-Midnight  
Fri.-Sat. 11:00 AM-2:00 AM  
OPEN SUNDAY 11:00-9:00 P.M.

**885 Starkweather • Plymouth.**  
459-0885

Selection of  
**HOLIDAY  
DRESSES**

*Beginnings...*  
**Bridal Shop**

640 Starkweather  
PLYMOUTH, MI (313) 459-8281

- Lovely Selection
- Personal Service
- Latest Styles

M & W, Fri., Sat., 10-5  
Tues. & Thurs. 10-8:30

Visit us Sunday  
12:00 - 6:00  
During the  
Christmas Walk

**PLYMOUTH  
YARD**

**HOBBIES  
& GIFTS**

LOCATED IN THE HISTORIC PLYMOUTH FREIGHT HOUSE

MODEL RAILROAD SUPPLIES  
ALL SCALES • OPERATING LAYOUTS  
AUTHORIZED LIONEL SALES & SERVICE  
LGB • KALAMAZOO • LIONEL • LARGE SCALE  
WOOD SHIP MODELS • PLASTIC MODELS  
MODEL PLANES • BOATS • CARS  
HOBBY RELATED GIFTS

Quality • Selection • Service  
Monday thru Saturday: 11 a.m.-7 p.m.  
Sunday (October thru March): 11-3 p.m.

**455-4455**

984 Starkweather - Trackside  
In Old Village - Plymouth

*Plymouth*  
Jewelry & Gifts

**A SHOWCASE OF VALUE**  
14 Kt. Gold - Diamonds - Gemstones - Watches  
Holiday Super Savings  
**50% Off All Rings in Stock**  
**50% Off Cultured Pearl &  
Diamond Jewelry**  
**20% Off SEIKO Watches**

- Custom Design: Manufacturers • FREE Layaway
- All Work Guaranteed • Gift Certificates
- We Replace Watch Batteries While You Wait.

620 Starkweather • Plymouth 453-1860

**HAPPY**

*Holidays*

TO OUR  
**VALUED CUSTOMERS**

Thank you for giving us the opportunity  
to serve you and your family. Heartiest wishes  
to you for a merry Christmas and a happy  
healthy and prosperous new year from all of us.

The  
**Community Crier**

821 Penniman • Plymouth, MI 48170 313-453-6900

## Holiday creations

# Plymouth artist crafts ornaments

BY DAN JARVIS

Christmas tree ornaments are always a big selling item during the holiday season.

One local artist, Don Schneider, of Plymouth, has dedicated many years to making hand blown glass ornaments, which have hung on trees all over The Plymouth-Canton Community.

Schneider has been working with hand crafted glass for 18 years, when he joined an adult education class at Greenfield Village in Dearborn.

And what began as a hobby is now a full-time job for the artist.

"It takes extremely good eye-to-hand coordination," he said. "Not everyone can do it well."

Schneider normally sells the tree ornaments wholesale, from locations such as the Detroit Institute of Arts, the John Leidy shop in Ann Arbor, the Collector Shop in the Forest Place Mall in Plymouth, and a new chain of stores called the Michiganian, featuring outlets in Birmingham and the Lansing area.

He has worked as an auctioneer with the Detroit Fruit Auction at the Detroit Union Produce Terminal, on Fort Street near the warehouse district.

"The ornaments sell for about \$10 each," said Schneider, "and the styles are unlimited."

The ornaments are fashioned in two basic shapes: Round balls and spirals.

The round family of ornaments have a wide variety of styles. Colors can be inserted into the center or added to the surface, he said.

The spiral ornaments are made from a long pyrex tube, melted and formed. Color stripes are laid onto the surface, much like decorating a cake with colored frosting. When stripes are added, they are red hot and cannot be distinguished from one another.

The tube is spun with one hand on each end and with one hand twisting faster than the other. Once cooled, the result is a fascinating multi-colored glass spiral Christmas tree ornament. The final step is the addition of the tree hanger and the piece is ready to hang on the tree.

There are two basic methods of glassworking, he explained. Lampworking is a tabletop method of re-forming glass into new shapes by heating the material with an open flame. Colors and additional shapes can be added to the ornament by melting the glass together. Schneider uses Pyrex because it can be cooled at room temperature, rather than with water, as with glass.

Furnace working involves the manufacture of glass from powdered chemical compounds in a large furnace. To obtain a high

temperature, the furnace takes several days to heat, he said.

"It's like a cake mix," said Schneider. "We put it in the furnace and melt it down."

The pieces of art formed with furnace working are generally larger and more involved. They also command a higher price because of the time and craftsmanship involved in the process.

"We have the only shop in Michigan to start with the raw materials," Schneider proclaimed, referring to himself and fellow artist Greg Green, also of Plymouth.

When asked if his work has appeared in art shows, Schneider replied, "I don't do art shows. I can't stand them."

As an artist, he doesn't like to explain the pricing of an item and the cost of raw materials and cost of living for an artist.

Schneider explained that during the last 10 years, the art of glassblowing has become more popular a craft, but that few are doing it full time.

"I enjoy the work," he said. "It is endlessly stimulating and satisfying. When I'm in a bad mood I come down here and make something beautiful."



Plymouth glassblower Don Schneider shows off his stuff prior to the start of the annual holiday celebrations in The Plymouth-Canton Community. Schneider is known for his Christmas ornaments. (Crier photos by Chris Farina)



PLUS



## Light up with luminaries

The Plymouth Symphony League and the Trailwood Garden Club will be selling holiday luminaries on Dec. 3, 10, and 17 from 10 a.m. to 4 p.m. at the Westchester Square Mall and at the K-Mart on Ann Arbor Road.

The price for 10 candles and a white bag is \$2.50. Individual candles and bags cost \$.25.

Based on the Spanish custom of lighting the way for the Christ Child, luminaries are to be used on Dec. 24 beginning at 6 p.m.

The bags can be filled with topsoil, kitty litter, or sand to hold the candles. They should be placed along the curb approximately ten feet apart.

Free sand is available for Plymouth residents from the Plymouth Department of Public Works, on Junction Street, on Monday through Friday between from 7:30 a.m. to 4:30 p.m. Plymouth Township's Department of Public works, on Lilley Road, will also be offering free sand from 8 a.m. to 4:30 p.m.

People are asked to bring their own containers and shovels.

For additional information call co-chairman Mary O'Connell 459-1999 or Alice Homan 455-7494.

## Luminaries light Canton

The Canton Beautification Committee will be selling luminaries at the Recreation Department at the Canton Administration Building on Canton Center Road through Dec. 10 or at the K-Mart at Sheldon and Ford roads on Dec. 3rd from 10 a.m. to 8 p.m.

Luminary kits, including white paper bags and candles, can be purchased for \$2.50. Sand for anchoring the luminaries is available at the Administration Building.

Getting ready for the luminary sale are (from left) Mary O'Connell, Alice Homan, and Sharyn Tidwell of the Symphony League and the Trailwood Garden Club. Plymouth and Canton groups will sell the luminaries. (Crier photo by Dan Jarvis)

*The Best  
of the Season!*

**Plymouth Cultural Center**  
presents

**The Christmas Arts & Crafts Show**

**Over 75 Crafters At Each Show**

Fri., Sat., Sun.

November 25, 26, 27

December 2, 3, 4

Show Hours:

Fri. and Sat. 11 AM - 6 PM

Sun. 12 AM - 5 PM

**FREE ADMISSION — PLENTY OF FREE PARKING**

525 Farmer St. • Plymouth • 455-6620

Sponsored by The City of Plymouth, Department of Parks and Recreation

All over the world . . .

# The holiday season brings joy

## Germany and Austria have hand-made holiday

BY DAN JARVIS

All over the world, other countries and cultures are preparing for the holiday season. And no matter what religion or political affiliation, most peoples celebrate the season in some special way.

In Germany and Austria, Santa Claus arrives early. On Dec. 5, Santa comes to homes and gives the good children sweets, said 28-year Plymouth resident Edith Scherer. The children who were not so good receive nothing but small chunks of coal.

On the four Sundays prior to Christmas, the people in Germany light candles to celebrate the Advent, or the coming of the Christ child. On Dec. 4, one candle is burned; Dec. 11, two are lit; Dec. 18, three, and so on.

Baked goods are an important part of the Advent celebration and a variety of cookies are baked at the beginning of December. During each of the four Sundays, the family gathers around the tree and shares cookies and coffee.

On Dec. 24, said Scherer, German people celebrate the birth of the Christ child. This is also the evening when gifts are exchanged.

"We have two holidays," she said. "On the 25th, we eat goose. This is when the family gathers to observe the celebration. On Dec 26, we go to visit relatives."

German and Austrian people pride themselves on the authenticity of the celebration.

"The tree is real, said Scherer, "We never have a phony tree. And we have candles instead of electric lights."

Most of the ornaments and household decorations are hand-made. Many of the ornaments are made of straw, pine cones and even edible chocolate, which are eaten throughout the holiday season.

## Polish customs have survived the centuries

BY DAN JARVIS

In Poland, the Christmas season is deeply religious and century-old customs are still observed by the majority of Polish families.

Joanne Ygeal, director of the Polish Centennial Dancers, said the Polish holiday begins on Dec. 6, with the arrival of St. Nicholas.

Old St. Nicholas brings small presents and sweets for good children, while the ones who have misbehaved receive a small handmade straw broom with wishes they will improve during the next year.

Stacia Peruski, who was born and raised in Poland, said virtually all children receive some small reward, even if they were unruly.

Polish women prepare early for the coming season, said Peruski, and gather ingredients for cooking. Hand-made ornaments are made of straw, paper and cookies.

"It is most important to have a nice tree, said Peruski. "We hang honey-cookies and eggs also.

"On Dec. 22, the women cook for three days and we make many kinds of cakes and cookies," said Peruski.

CONTINUED



## Festival of Dolls

To celebrate Dessara, or the Festival of Dolls, many Indian people set up a display of dolls and other items. Anandini Chandrasekhar (left) plays a tamboora while her sister Anjali plays the mridangam drum. (Crier photo by Dan Jarvis)

## In India, the holidays are special for all

BY DAN JARVIS

Because Canton has a significant Indian population, the holiday season is an eclectic mix of celebrations as Muslims, Hindus and Christians celebrate several events during November and December.

During mid November, the Deepabali festival of lamps is observed, said Dorai Swamy, of Canton.

As Swamy's daughter, Sudah Chandrasekhar, explained, early in the morning, Indians in their native country awake and apply sesame oil to their head to attract the goddess of wealth, Mahalakshmi.

After a short period, the oil is washed off with soap nut powder and the people adorn themselves in new and colorful clothing.

All during the festival of lamps, lights and candles in homes are lit, also to welcome the goddess.

Because India has many Christians, the Christmas holiday, also called the Winter Festival, is observed by many.

In India, the Winter Festival includes the Pushkar Cattle Fair. During the fair, said Chandrasekhar, milk-giving cattle are honored and decorated with flowers.

In more of the Western tradition, Christian churches feature large masses where bread and wine is distributed to honor Jesus Christ.

"It's a very religious ceremony," she said. "People dress beautifully and we have wonderful prayers. We have good time.

"For Hindus," said Chandrasekhar, "Christmas is a social holiday because people have the day off work. Families will visit relatives in other cities and states."

The Muslim religion in India differs greatly from Christianity, especially during the holiday season. During December, Muslims dress in new clothing and put aside any fighting ways. The season is set aside for peace and tranquility, said Chandrasekhar.

Traditionally Muslims, who use the luna, or moon, calendar, will fast for 30 days until the new moon is visible. At this time a pourage is made and the Holiday feast begins.

In a land with nearly 800 languages, the customs vary widely, she said, but all over India it is a special time for all.

# GIVE THE GIFT THAT KEEPS ON GIVING .....

EVERY WEDNESDAY

MAIL DELIVERY to Anywhere  
in the USA or to Any A.P.O.

\$20.00/yr.

HOME DELIVERY

\$14.00/yr.

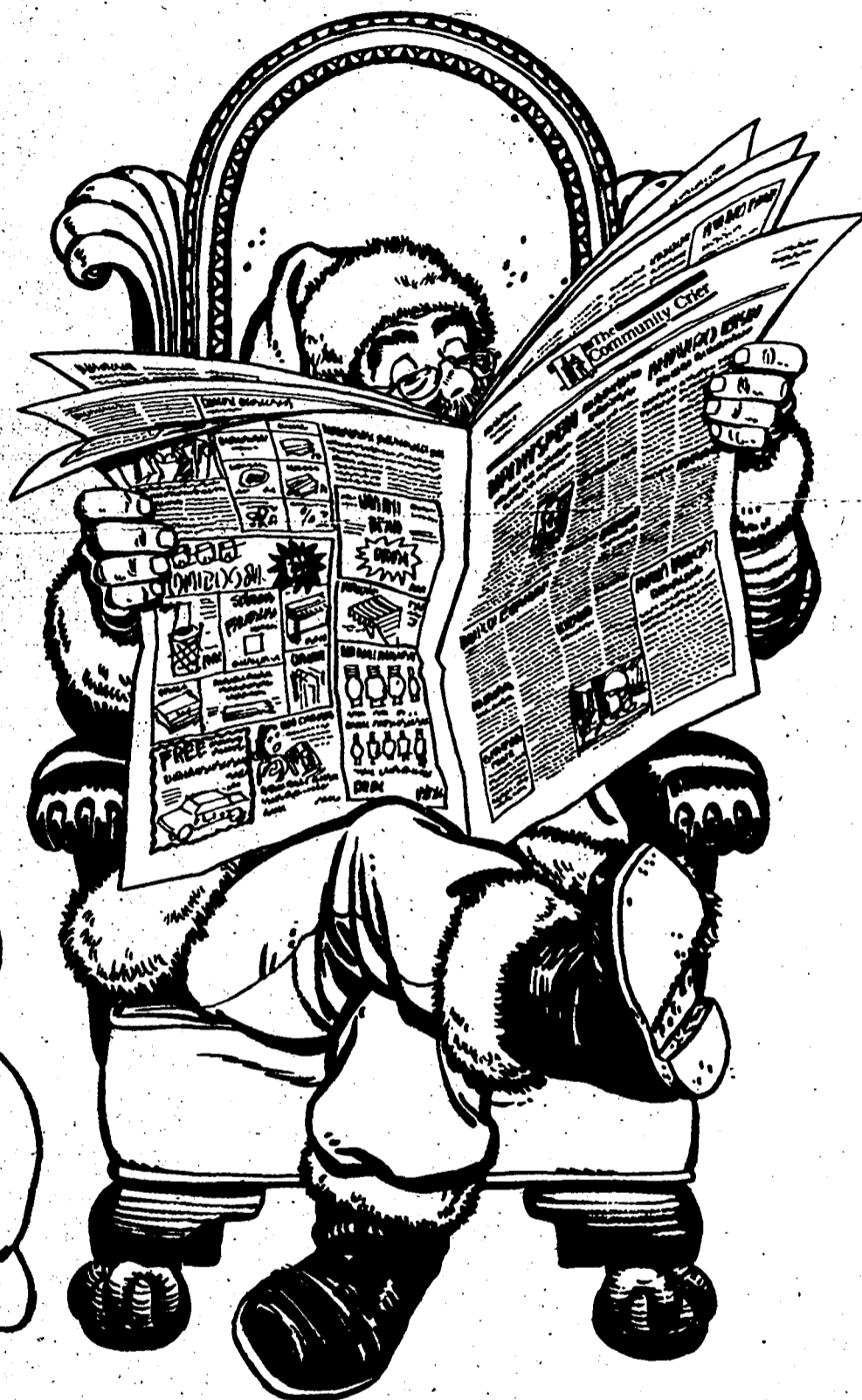
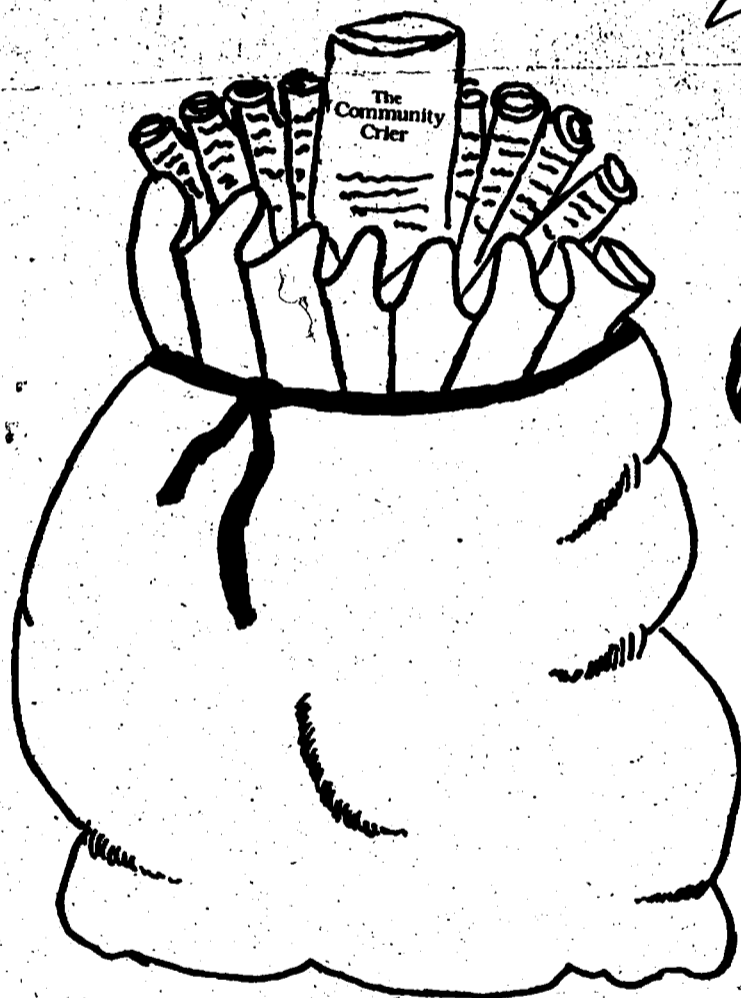

CALL 453-6900 To order your gift subscription



## The Community Crier

821 Penniman • Plymouth, MI 48170 313-453-6900

# Polish customs survive

## CONTINUED

As Ygeal explained, everyone decorates the family tree on Dec. 23.

"We hang big shiny red apples from the trunk," Peruski said. "We also put candles on the tree."

Dec. 24 is known as Wigilia Day, said Ygeal, and straw is placed under the dinner table to represent the manger in which the child Jesus was born.

When the first star appears in the evening sky, a vast feast takes place with numerous varieties of dishes. Because meat is not served during Wigilia, fish is prepared in several ways.

One custom still observed is that of leaving an empty chair at the table for the place of God. The symbolic chair is often filled by a stranger who is invited in to feast with the family.

According to Polish custom, if the chair is left empty during the entire feast, the family will experience bad luck during the coming year. Following the meal the family prepares for the midnight mass to honor the birth of Christ.

On Dec. 25 and 26, said Peruski, huge feasts take place and relatives and friends are visited.

The meals consist of meat dishes such as Kielbasa, pierogis and hunter's stew, known as bigos.

The entire Christmas celebration lasts until Jan. 6, known as Three Kings' Day.

Ygeal said many people leave their tree up until well after Christmas day to honor Christ, the three kings and St. Steven.

All through the holiday season Polish people wish luck and good fortune onto family and friends to secure a good coming year with wealth and prosperity.



## Hurray for Gene 'Santa' Reaves

The area's oldest Santa, Gene "Santa" Reaves, a former Canton resident, is again asking for donations for the Santa Christmas Fund. Cannisters are set up at Denny's on Ann Arbor Road, Johnson's in Canton, Blazo's and Big Ben's in Westland, the Easy Rider, Magic Meal restaurant and the Capitol restaurant. The money goes to help needy kids and families throughout the area. The 86-year-old Santa said, "As long as I can move I'll be a Santa Claus." Donations can also be sent directly to Gene at 37789 Hixford Rd., Apt. F12, Westland, 48185. The money will be used for mittens, hats, sweaters, and candy canes for kids. Gene, an original J.L. Hudson's Thanksgiving Parade Santa, has been helping the needy for more than 25 years. (Crier photo by Chris Farina)

## Youths can meet Santa

Plymouth youths can meet with Santa Claus at his house in Kellogg Park in downtown starting on Friday (Nov. 25) from 6:30-8 p.m.

The hours will be open every weekend until Christmas. Hours are 4-8 p.m. on Friday, 10 a.m. to 5 p.m. on Saturday and noon to 5 p.m. on Sunday.

As in years past the Plymouth Community Chamber of Commerce will sell photographs with Santa for \$3.50.

## Christmas art show on tap

Quite a tradition has been building around the City of Plymouth Parks and Recreation's annual Christmas Arts and Crafts Shows held at the Cultural Center.

This year the shows will be held on Friday, Saturday and Sunday (Nov. 25-27) and again on Dec. 2-4. Show hours are from 11 a.m. to 6 p.m. on Fridays and Saturdays and from noon to 5 p.m. on Sundays.

Each show features more than 75 artisans. Admission is free.

"Each year about the first of November we start getting calls at the recreation department wanting to know the dates of our Christmas Arts and Crafts Shows," said Tom Willette, show director.

Grandma

Grandpa



of Plymouth

December 1, 2, 3

9 - 10 A.M. (only)

Grandparents and their grandchildren have a special relationship. Recognizing this, the RAINBOW SHOP of Plymouth is providing grandparents with a "crowdless" morning of shopping — just in time for the Christmas season.

This ad entitles grandma or grandpa to a 15% discount on all items in our store on December 1, 2, 3 between 9 and 10 A.M. (only). Refreshments will be provided.

— No other discounts apply —

873 W. Ann Arbor Tr.

459-5580

# For everyone who has more to do, than time to do it

## NBD introduces the Telephone Banking Center<sup>SM</sup>

Now, one number lets you do almost anything you can do at an NBD branch. On the phone. Seven days a week.



*For Jennie Moore, who has her hands full, day and night.*

Now you can open new accounts.  
Apply for a loan.  
Transfer money between accounts.  
Pay bills. Get answers to questions about your accounts.  
And much more.

And there's *no charge* for using the service.

When you call, you'll talk with one of our Customer Service



*For Sandra Thomas, who's working through lunch, again.*

Representatives, a professional who can provide fast, friendly service.



*For Bart Moony, who works while the rest of the world sleeps.*

The Telephone Banking Center. It's for everyone who ever wanted an easier way to bank. And it's only at NBD.

*For Al Morgan, who never knows when he'll be off the job.*



### Telephone Banking Center<sup>SM</sup>



*For Cliff Taylor, who's on call 24 hours a day.*

# 862-4-NBD

1-800-CALL-NBD  
Outside Tri-County Area

**HOURS** Customer service representatives: Monday-Friday 8 a.m.-9 p.m., Saturday 10 a.m.-5 p.m., Sunday Noon-5 p.m. • TBC Plus automated service: 24 hours a day, 365 days a year

Member FDIC

*Happy Holidays*

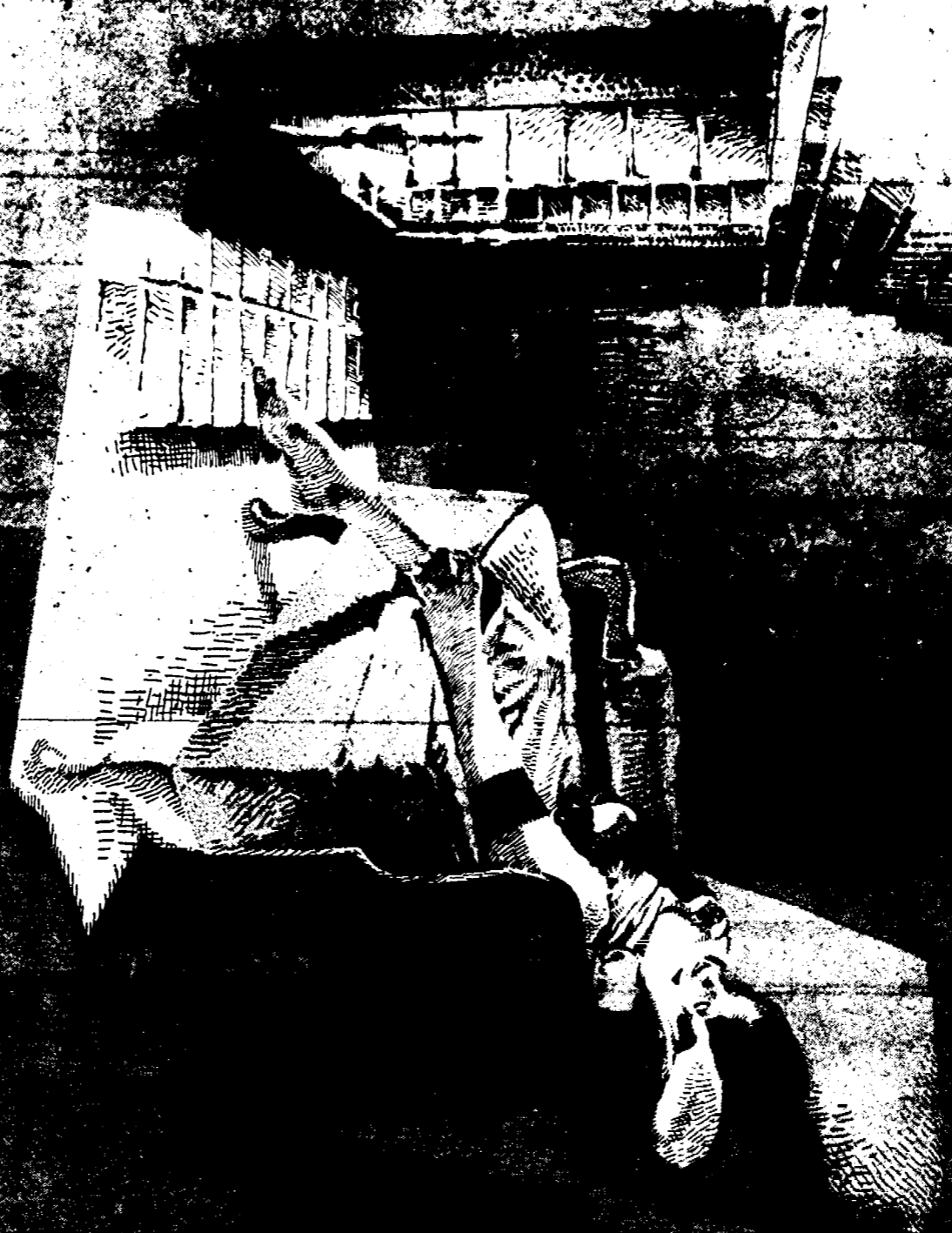

**And a child's smile that  
is temporarily absent**

**Holiday Memories... yours and  
First of America's... by...**

**HOME**

# Santa comes to Canton!

Meet Christmas Carol  
and Mrs. Santa too!



## Friday, November 25

9 a.m. at the Canton Cinema Six on Ford Rd. The 1st 500 children receive a free movie, goodie bag and refreshments. This event is sponsored by the Canton Chamber of Commerce.

Everyone attending is encouraged to contribute a can of food for Omnicom's "Baskets Filled With Love" Food Drive.

# Kids Crossing

Children's Apparel



Located in the F & M Center  
42045 Ford Rd., Canton

981-7111

"Our Specialty is Service"

Preemie to Size 14 — Boys & Girls

**50% OFF**

All Weather Tamer Jackets & Snowsuits

Everyday 20% Off Name Brand Clothing

\*(starting at 3 mos.)

Holiday Hours

Mon. - Fri. 10:00 - 9:00

Sat. 10:00 - 6:00

Sun. 12:00 - 4:00

Free Gift Wrapping • Free Lay Away



"I back the family insurance I sell with good neighbor service."



And our computer system makes that good service even better. Call me.



Like a good neighbor, State Farm is there.

**Frank McMurray**

5773 Canton Center Rd.

455-3200

# KaDe's Hair Cutting Co.

Our Children's Room makes haircuts fun for kids!

42013 Ford Rd.  
(in F & M Center)

981-6190

NO APPOINTMENT NECESSARY  
Monday Thru Friday 9 - 9, Saturday 9 - 6

Adult Women's Cut Special

**\$8.95**

Regular \$12.00

With Coupon Expires 12/31/88

Adult Men's Cut Special

**\$7.95**

Regular \$9.00

With Coupon Expires 12/31/88

Adult Perm Special

**\$5.00 off**

With Coupon Expires 12/31/88

# Canton Rental

Need it? Rent it!



Rent the Rug Doctor Carpet Cleaner!

- Log Splitters
- Brush Chippers
- Wallpaper Steamers
- Stump Grinders

New!

CONCRETE TO GO

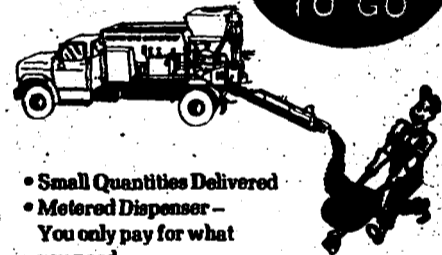

6438 Canton Center Rd.  
(between Ford and Warren)

455-0844

- Small Quantities Delivered
- Metered Dispenser — You only pay for what you need.
- Mon. - Sun. Delivery

# Classic Gold

We wish you a Merry Christmas from your Neighborhood Jewelers, with these Holiday Specials!

- Bulova, Citizen Watches 20% off
- Largest Selection of Watches in Canton
- Diamond 35% off Retail

Fast Expert Jewelry Repair

Every Day Discount Prices • We Buy Gold

Many Fashion Rings to Choose From • Wide Selection of Silver

42081 Ford Rd. (in F & M Center)

Mon. - Sat. 10-9, Sun. 11-5

981-0808

**FREE**  
Floating Heart  
with any chain repair  
at **\$2.00**  
**FREE**  
Gift Wrapping  
with any purchase.



# WOODLAND MEADOWS Sanitary Landfill

Licensed by the State of Michigan

All loads must be covered.

Van Born Road • west of Hannan • 326-0993



A Waste Management Company



Give the Gift  
of a Good  
Night's sleep ...



Featuring "Dream Weaver", the ultimate waterbed mattress, 100% made in the U.S.A., with a 14 year warranty. Available in semi-waveless, waveless and completely motionless. At competitive prices.

**Canton Waterbeds**



41812 Ford Rd.  
in Fountain Square  
(next to Mena Do-It Center)  
**Canton**  
**981-4314**

**SEASON'S GREETINGS**

from

**Firestone**

**Canton's Home For Car Care**

44120 Ford Rd. Canton  
459-0777

**Call for Holiday Savings!**

**ENTRE'E EXPRESS**

Gourmet Shoppe  
Carry-Out & Catering

**SPECIAL HOLIDAY MENU**

Traditional & Contemporary

**\$2.00 off PRIME RIB DINNER**

or Baked Orange Roughy

FRIDAYS ONLY. Includes potato, vegetable, salad & muffin.  
Reg. \$7.95. Expires 12-2-88. Limit one per customer. With this ad.

Different Dinner Entrees every day. Pick up a weekly menu.  
— Open for Lunch —

8489 Lilley Rd. in Golden Gate Center

(1/4 mi. south of Joy Rd.)

M-F 11 a.m.-7:30, Sat. 10-4 p.m. Delivery Available

**454-0960**



Roll into the holidays at the

**Skatin' Station**

**VISIT OUR MODERN SKATE SHOP**

For all your Christmas skating and gift needs. Open 10 a.m. til 9 p.m. Monday through Saturday in November and December.

**BUY AT THE SKATIN' STATION**

- A) Knowledgeable Sale People
- B) Replacement Parts
- C) Large selection of quality skates
- D) We service what we sell!



Package #1  
**CONCORD SPECIAL**  
**\$89.95**  
102 Boot.  
Concord Speed Plates.  
Precision Bearings.  
Concord Wheels.



Package #2 - Best Value!  
**PACER FORMULA II**  
**\$159.95**

Leather Boot.  
Precision Bearings.  
Lubeda Turbo  
Inserted Wheels  
(black or white).

**COMPLETE ROLLER SKATES STARTING AT...**

**\$44.95**

Large Christmas Stock!

**Bonus!**  
A Package of Passes with each Skate Purchase!

Coming: Thanksgiving  
Invitational Speed Meet  
— November 25 and 26

8611 Ronda Dr.  
Canton  
(off Joy Rd.)  
**459-6401**



Perfect stocking  
Stuffers —  
Our Gift Certificates

**Skatin' Station**  
**2•4•1**  
**ADMISSION**  
at our New Friday Session  
6:30 - 9:00 PM  
Expires 12-30-88

**Skatin' Station**  
**\$1.00 OFF**  
**FAMILY ADMISSION**  
at our New Family Session,  
Wednesday 6:30 - 9:00 PM  
Reg. \$5 for entire family.  
Skate Rental extra.  
Expires 12-28-88





# Community Deaths

## Bakewell funeral empties community restaurants

BY W. EDWARD WENDOVER

Anyone who tried to get a restaurant meal or a drink in The Plymouth-Canton Community Monday knew Ken Bakewell had died.

The funeral and burial for Bakewell, popular proprietor of the Sidestreet Pub and the Press Box Tavern, drew waitstaff and owners of many food and drink outlets from the community. Some closed operations for a time.

Many of the bars' patrons -- from bankers and auto workers to newspaperfolk and management consultants -- also attended services.

Even those restaurant staffers who didn't attend services, mourned the popular colleague to their customers.

Bakewell, 64, of Northville, died Saturday of cancer which had been diagnosed less than six weeks earlier.

Many of his friends in the restaurant business spent the day relating stories of Bakewell's generosity -- how he'd loaned \$500 to one in need, how he'd bailed an unfortunate patron out of the Plymouth jail.

Bakewell was instrumental in launching the Jim Symonds scholarship which honors Plymouth-Canton students who have participated in junior

sports. In just three years, the scholarship has doubled in size.

He came to The Plymouth-Canton Community in 1972 from Detroit and quickly befriended many of those in the business. His partner in the Sidestreet, Joy Hollen, was an example. "He taught me a lot, and we're going to keep things running like he wanted," she said.

Although at the Sidestreet, on Fralick behind the Plymouth Post Office, for 15 years, Bakewell, Hollen, and Steve Corte had just completed the purchase of the Press Box, on Ann Arbor Road near Sheldon. "We'd just dried the ink on this, when Kenny found he had cancer," Hollen said.

Arrangements were made by Ross B. Northrop & Son Funeral Home in Northville with Rev. Leslie F. Harding officiating. Burial was in Glen Eden Cemetery in Livonia.

Survivors include: wife Betty, of Northville; mother; Gladys Killbride, of South Lyon; daughters Kathleen Benchick, of Dearborn, Cindy Green, of Livonia, and Christine Foley, of Canton; sister Joan D'Amato, of East Detroit; brother, Robert Killbride, of South Lyon; and 11 grandchildren.



KEN BAKEWELL

## Sneddon, born in Scotland

Sarah C. Sneddon, 86, of Westland, died Sept. 28 in Westland. Mrs. Sneddon was born Sept. 9, 1901 in Scotland.

Survivors include: son Charles, of Millersburg; daughter Margaret Murphy, of California; six grandchildren and five great-grandchildren.

Local arrangements by Schrader Funeral Home of Plymouth.

## Cook, Canton Pioneer

Irene J. Cook, 89, of Plymouth Township, died Oct. 25 in Plymouth. Services were held Oct. 28 at Schrader Funeral Home with Frederick C. Vosburg officiating.

Mrs. Cook was a homemaker, a member of Eastern Star No. 115, Plymouth, a member of First United Methodist Church's 60 Plus Club. She also held memberships in the Plymouth Seniors and the Canton Pioneers.

Survivors include: sisters Elsie Cole and Ernestine Reddeman, both of Plymouth.

Interment was in Riverside Cemetery, Plymouth.

## McGinnis, an accountant

Lawrence V. McGinnis, 87, of Whitmore Lake, died Oct. 26, in Ann Arbor. Services were held Oct. 29 at Schrader Funeral Home with Father Rene Wilson officiating.

Mr. McGinnis was an accountant.

Survivors include: sisters Edna Horton, of Rome, GA; Christine Harron, of Alabama; brother Coy, of Georgia; friend Glenn W. Ford, of Whitmore Lake.

Interment was in Riverside Cemetery, Plymouth.

Memorial contributions may be made in the form of mass offerings.

## Pryor, a homemaker

Pauline H. Pryor, 79, of Chicago, died Nov. 8 in Chicago. Services were held Nov. 12 at Schrader Funeral Home with the Rev. Kenneth F. Gruebel officiating.

Mrs. Pryor was a homemaker.

Survivors include: son Robert E., of Chicago; sister Ann Musu, of Mount Clemens; two grandchildren and two great-grandchildren.

Interment was in Riverside Cemetery, Plymouth.

Memorial contributions may be made to the Northwestern Memorial Hospital's Hospice Care Division.

## Roettger, band member

Milton Roettger, 82, of Canton, died Nov. 12 in Plymouth. Services were held Nov. 15 at Lambert-Vermeulen Funeral Home with Jerry Yarnell and Drex Morton officiating.

Mr. Roettger was retired as a superintendent of the Excello Corp. He was a member of St. Michael Lutheran Church in Canton, a member of the Canton Kitchen Band for 10 years. He also held memberships on the Plymouth Landing Condominium Board (16 years), and the Pioneer Senior's Club. (15 years).

Survivors include: wife Gertrude, of Canton; daughters Carol Walters, of Canton, Janet Simpson, of Detroit; sisters, Elnora, Millie, Harriet, Althea, and Evelyn Sensel, all of Kentucky; and six grandchildren.

Interment was in Cherry Hill Cemetery, Canton.

Memorial contributions may be made to the Salvation Army. Envelopes at funeral home.

**IN YOUR TIME OF NEED  
WE CARE**



**Pre-planning  
can save you grief**

The thoughtful art of pre-planning a funeral assures the dignified service you want, at the cost you predetermine. Pre-planning can save your loved ones a lot of grief. Call on us; we can help.



**LAMBERT-VERMEULEN  
FUNERAL HOME**

46401 Ann Arbor Rd.  
(1 Mile West of Sheldon) Plymouth, Mich. 48170 **459-2250**

# Seniors share Thanksgiving dinner

Thirty two senior citizens indulged in a traditional Thanksgiving dinner free of charge on Nov. 17 at the Masonic Temple in Plymouth thanks to the efforts of several community service groups participating in the National Thanksgiving Dinner program.

Local participants in the program were the Plymouth Rock Lodge No. 47 and the Wm. M. Perrett Lodge No. 524 F and M, the Great Western Scottish Rite Club, the Plymouth Jaycees, and the "We the People" Bicentennial Committee of

Plymouth; Tyrian Lodge No. 500.

The National Thanksgiving Dinner program is centered in Washington and was created to foster grassroots and private sector involvement in the fight against hunger and homelessness throughout the country and to promote a nationwide expression of thanksgiving.

Spokesman Ron Lowe said the participating organizations hope to hold a fundraising dinner next year and use the money to provide solutions for local hungry and homeless people.



## Getting down to business

*Gravity got you down?*

### Let a Rolfer straighten out your kinks

BY PAUL GARGARO

Excuse me, but just what in the heck is Rolfling?

Most likely, that's not a question readily asked, but for residents in The Plymouth-Canton Community, the answer is just around the corner.

Introducing Jeff Belanger, Certified Advanced Rolfer.

"Rolfing is an educational experience. It's a way to discover and learn how to find your balance," said Belanger, who recently opened a Rolfing practice on 219 S. Harvey. "I call it balance education -- so gravity doesn't pull you all over."

Developed by Ida P. Rolf, Ph.D., Rolfing is a process of aligning the body with the earth's gravitational field by physically manipulating its soft tissues or fascia, which envelope our muscle fiber.

"The body is a system. If you don't treat it as such, it won't work," said Belanger. "Rolfing releases old pat-

terns and bad habits. Gravity will pull you down into a pattern.

"Rolfing makes the body open and responsive," said Belanger, who added that chiropractors have told him that patients who have gone through Rolfing are often more responsive to therapy.

"I was Rolfed in 1979 and it blew me away," said Belanger. "I'm a Rolfer now because it really does work. It speaks for itself."

Rolfing consists of 10 hourly sessions, working on the soft tissues with the hands.

Belanger, who recently moved here from Waterford, said his current practice includes clients ranging from a nine-year-old girl to a 60-year-old man.

Joining Belanger's Plymouth office is physical therapist Pamela Perkins. Said Belanger: "Now we'll have two Rolfers in downtown Plymouth."

In addition to Rolfing, Belanger said he is currently organizing a local support group for sufferers of chronic neck and back pain.



### A fine balance

Certified Rolfer Jeff Belanger and a friend relax in his new Plymouth office on N. Harvey Street. (Crier photo by Chris Farina)

### BPW wants contestants for career competition

The Canton Business and Professional Women's Club is looking for candidates for its annual Young Careerist competition.

To qualify women must be between the ages of 21 and 23; have been employed in a business or profession with at least one year of full time work experience; must be outstanding in scholastic work, community service or church work; and must be willing to support the goals and objectives of the National Federation of Business and Professional Women's Club.

For an application form or further information call the YCW Chairperson, Rosemary Kosovac, at 227-7787 or Teresa Solak at 981-5900.

Application forms will also be available at the First of America Bank-Wayne branch office on Ford Road.

### Business people

E & E Fastener Company, Inc., of Plymouth, was recently presented with Ford's Q1 Preferred Quality Award at a recent luncheon in Dearborn.

The Q1 award has been presented to nearly half of all Ford suppliers. E & E Fastener Company, Inc. manufactures stampings and stamped fasteners for Ford vehicles.

Plymouth resident Don Kenney has opened an IDS Financial Services office at 158 North Main Street in Plymouth. An American Express Company, IDS has been in the financial services industry for nearly 100 years.

The new IDS center will offer personal financial planning services and group and life insurance, pension plans and business valuation services for the business owner.

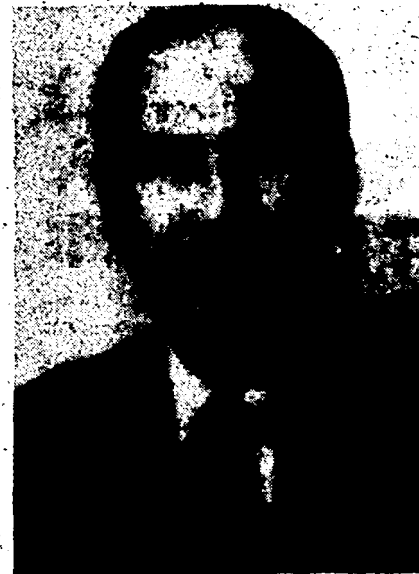

DON KENNEY



## Places to be

# Chorus goes Christmas

The Plymouth Community Chorus will be presenting its annual Christmas concert -- "Merry Christmas With Love" -- on Friday and Saturday, Dec. 2-3 at 8 p.m. and on Sunday, Dec. 4 at 4 p.m. in the Salem High auditorium.

The 15th annual concert by the chorus features sacred and secular songs of the season. The theme is borrowed from the song recorded by Sandi Patti.

Organized in 1973 with less than 25 members, today the chorus numbers more than 140 voices from Highland to Wayne and most towns in-between. It is under the direction of Michael Gross, of Westland.

Tickets for the holiday show may be purchased at Sideways in Plymouth, Bookbreak in Canton, and The Gitfiddler in Northville as well as from chorus members.

Tickets are \$5 for adults and \$4 for senior citizens and children.

Group rates are also available. For ticket information call 455-4080.

## Career testing set at Canton

Canton High will be offering the CPP Test (Career Planning Program) for interested 11th and 12th grade students on Saturday, Dec. 3.

Registration for the test runs through Nov. 28. Students can sign up at the Canton Career Center located in

the Guidance and Counseling Center at Canton. There is a \$4.50 non-refundable fee at the time of sign-up.

The test measures interest, abilities, and experiences and aids students in building a career planning profile. It is designed to provide students with career related information.

**Ad Advice #573**

If the item is a known brand, say so in your advertising. Manufacturers spend large sums to sell their goods, and you can capitalize on their advertising while enhancing the reputation of your store by featuring branded items. Using the brand name may also qualify the ad for cooperative advertising allowances from the manufacturer.

For expert advice with no obligation ...  
Call The Community Crier  
453-6900.

# P-C police forces will switch to 9-1-1

BY KEN VOYLES  
AND PAUL GARGARO

When local police departments switch over to "enhanced 9-1-1" emergency service next spring Canton's Public Safety Director John Santomauro said police response times may be reduced.

As a part of a statewide program, 17 Wayne County communities should go on line in March, 1989, including Canton, Plymouth Township and the City of Plymouth. The city is currently on "basic" 911, while both townships use regular outside phone lines.

"This system is going to reduce response times and, I believe, cut down on the number of prank calls," said Santomauro, who added that the system allows for calls to be "segregated" by community. "That's a real benefit," he said.

The system pinpoints the origins of a call, allowing departments to note any special circumstances surrounding a particular building or site, and then forwards the call to the local police or fire team.

The current 911 service does not segregate emergency calls, said Santomauro. Canton residents who use 911 usually tie in to the City of Plymouth's police line.

"Enhanced 9-1-1 is one of the most sophisticated and one of the best systems to come along in public safety in years," said Santomauro.

Richard Myers, the city's police chief, said the new system will give

police departments a full readout on the origins of the call as well as a hard copy version.

"Enhanced 9-1-1 computer will do selective re-routing and will greatly cut down on the number of superfluous calls," said Myers. "When our system is overflowed, calls can be designated to our overflow department."

The new system also bills calls to a resident's phone line, said Santomauro.

To start the system it will cost each community approximately \$49-54,000 in equipment, said the Canton chief, who added that yearly maintenance costs are expected to be about \$4,500.

Funding has already been approved by both governing boards in Canton and Plymouth Township. The city commission approved the system recently.

"This has been a project that every city, township and village in western Wayne County has had to work on cooperatively, and it's been very encouraging," said Myers. "The technology is expensive, but what price can you put on someone's life?"

The city is also getting a machine which will allow deaf residents to call in during emergencies. The system is known as Telephone Device for the Deaf (TDD).

According to Plymouth Township Police Chief Carl Berry, the enhanced system will feed calls directly to his department, avoiding any delays as when they go through the city's system first.

# Canton Board considers supervisor's role, pay

Continued from pg. 3

professional "manager," or superintendent and leave the supervisor's post a part-time one.

At the same time voters also elected Yack as supervisor, despite the fact that he agreed with the need for a professional superintendent and a part-time supervisor.

Shortly after being elected Yack said he communicated his desire to restore the position to full-time, but the previous board did not act on it.

In a request for board action, Yack said, "The lack of a decision has led to much speculation and many rumors. This issue must be resolved."

He added that in the absence of a trained public administrator it was imperative that the supervisor function as full-time manager.

Yack also wants the board to follow the Merit Commission's compensation recommendation for the supervisor and authorize a salary of \$43,000.

Yack, a school teacher with the Wayne-Westland Public Schools, plans to take a leave from teaching by the end of January, 1989. He has said he would not apply for the leave until after a decision by the board last night.

"My gut feeling is that there'll be no problem because the board sees the wisdom of a full-time position and because the board knows of my plans to take a leave," Yack said back in October.

## R-rated policy

Continued from pg. 5

to block us," said Daskalakis, "Then we will look at recalls."

Homes concluded by saying, "If CBE feels there is some deliberate kind of conspiracy, that couldn't be farther from the truth. There is no concerted effort to promote this kind of material."

Hoben said he expects to issue a policy recommendation in the coming weeks to the school board based on the findings of an R-rated committee he formed in September.

Feature your business in Dial It Shopping.  
Call 453-6900 for more information.

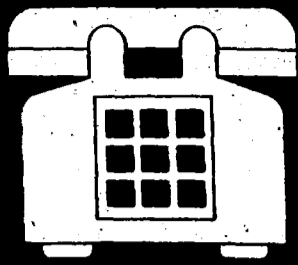

# DIAL IT SHOPPING

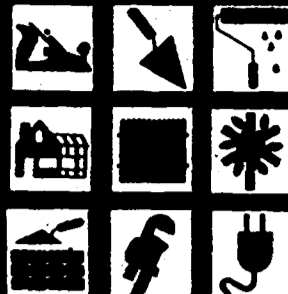

**AUTOMOTIVE CARE**

**TOM'S CUSTOM AUTO INC.**

- Body Repair & Painting
- Auto Reconditioning
- Polishing & Waxing
- Interior Cleaning
- Engine Cleaning

453-3639  
770 Davis - "Old Village" Plymouth  
A Little Out Of The Way...  
**BUT WORTH IT!**

**BRICK WORK**

**D.W. Bidwell  
Masonry**

- Brick
- Block
- Concrete

Located in Plymouth  
**451-1513**

**CATHOLIC KINDERGARTEN**

**COME LITTLE CHILDREN**  
45050 Warren Road  
Canton

State certified educators  
for preschool, day care,  
latch key & kindergarten

Wholesome & loving atmosphere  
ages 2½ through 12 yrs of age  
**455-4607**

**EVENT & MESSAGE**

**E. MORGAN HUMECKY  
CONTRACTING, INC.**  
8787 Chubb Rd., Northville  
348-0066 532-1302

Repairs • Residential • Commercial  
Porches • Patios • Driveways  
Feelings • Garage Floors • Experienced  
Licensed • Insured • Free Estimates

**CHILD CARE PRESCHOOL**

**HUGS & KISSES CHILD CARE  
& LEARNING CENTER, INC.**  
249 S. Main  
Plymouth 459-5830  
Register now

**LOVING CHILD CARE  
PRE-SCHOOL  
KINDERGARTEN**

Ages 2½ to 8 • Open 7 am to 6 pm  
Full and Half Days • Small Classes  
Affectionate Qualified Teachers

**CUSTOM BUILDERS**

**HOMÉ TOWN BUILDERS  
Plymouth**

Your complete residential  
building company. Guaranteed  
top-quality workmanship at  
reasonable prices.

- Custom Homes
- Kitchens & Bathrooms
- Decks & Additions
- Windows & Vinyl Siding

**FREE ESTIMATES  
Call 459-3232**

**DANCE**

**JOANNE'S DANCE  
EXTENSION**

42193 Ann Arbor Rd.  
PMC Center • Plymouth  
455-4330

Ballet — Tap — Jazz — Pre-School  
Gymnastics — Fitness  
Baton — Cheerleading

**Professional and Certified  
Instructors**

**DRIVING SCHOOL**

**MODERN SCHOOL  
OF DRIVING**  
29200 Vassar  
Livonia  
476-3222 326-0620

State approved teen classes starting  
monthly at Plymouth Cultural Center.  
Private adult lessons available.

**ELECTRICAL**

**KEETH**

- HEATING
- COOLING
- ELECTRICAL

**ONE CALL FOR ALL  
453-3000**  
400 N. MAIN PLYMOUTH

Why not the best?  
**LENNOX PULSE**  
Free estimates VISA  
Licensed/Insured MASTER  
Since 1951 CARD

**FLOOR COVERING**

**NOE'S CUSTOM FLOORS**  
2160 E. Michigan Ave.  
Ypsilanti

Linoleum - Carpet  
Hardwoods

Sales and Expert Installation

"Over 70 Years of Experience"  
**BOB or DAVE NOE 481-1180**

**FURNITURE REFRESHING**

"Preserving Our Heritage"  
**PLYMOUTH FURNITURE  
REFINISHING**  
331 North Main  
Call Jay Densmore  
453-2133

- Refinish & Repair
- Hand Stripping
- Antique Restoration
- Antique Reproductions
- Buy-Sell Antiques

**HEATING**

**PUCKETT CO., INC.**  
412 Starkweather  
Plymouth, MI  
453-0400

- Air Conditioning • Heating • Plumbing
- Sewer Cleaning • Visa • Master Charge
- Night & Day • Licensed • All Areas

**HOME IMPROVEMENT**

**KITCHENS**

- Cabinets • Counter Tops
- Vanities • Additions
- Rec. Rooms • Siding
- Windows • Doors • Enclosures
- Decks • Baths • Awnings

**ROSEDALE KITCHENS**  
459-2186  
Licensed Builder • Free Estimates

**HOME MARKETING**

Call Your Home Selling Team,

**LEE & NOEL BITTINGER**

For ALL Your  
Real Estate Needs

Coldwell Banker Bus: 458-8888  
Res: 458-8818

**INSULATION**

**AIR TITE INSULATION**  
882 N. Holbrook  
Plymouth 453-0250

Save on the cost of heating-cooling  
Fast Professional Insulation  
Blown-Blanket-Spray On  
"Your comfort is our business"  
Since 1960

**INSURANCE**

**CHUCK HEMPEL  
FARMERS INSURANCE GROUP**  
42303 Ann Arbor Rd.  
(PMC Center) Plymouth  
**455-1141**  
LIFE IRA'S  
HOMEOWNERS  
AUTOMOBILE  
COMMERCIAL

**KITCHENS**

**RAY R. STELLA  
CONTRACTING, INC.**  
747 S. Main Plymouth  
459-7111

Let us create a room that will  
truly reflect your tastes and  
lifestyle and we'll allow you to  
work with ease and con-  
venience.

Full Financing • Free Estimates

**LAWN MAINTENANCE**

**STULTS & SONS  
LAWN CARE**  
5736 Tower Road  
Plymouth, MI 48170

- Mowing & Edging
- Spring Clean Up
- Fall Clean Up
- Shrub Trimming
- Snow Plowing & Salt

Ask for LeeRoy 453-1849 or 349-4330

**LAWN SPRAYING**

**PLYMOUTH LAWN  
SPRAYING**  
Established 1972  
Fertilizer -  
Granular or Liquid  
Fungus • Weed  
Crabgrass Control  
Aerating • Insect Control  
165 W. Pearl  
Plymouth 455-7358

**PLUMBING**

**ENGLAND PLUMBING &  
SEWER SERVICE INC.**  
41801 Wilcox, Plymouth  
455-7474

- Water Heaters • Plumbing
- Repairs • Modernization
- Sewer Drain Cleaning
- Garbage Disposals
- Emergency Service • Fixture
- Replacement
- Frozen Pipes Thawed

**REAL ESTATE**

Buying or Selling?  
Contact Your Home Marketing Expert

**JUDY RUMPEL**  
For A Professional Home  
Market Analysis

218 S. Main, Plymouth 48170  
OFFICE: 453-6900  
HOME: 459-2792  
Schwitzer Real Estate, Inc.  
Better Homes and Gardens

**SEWER CLEANING**

**PUCKETT CO., INC.**  
412 Starkweather  
Plymouth  
453-0400

Sewer Cleaning • Plumbing  
Heating • Air Conditioning.  
Visa • Master Charge  
Night & Day Service  
Licensed • All Areas

**TURF CARE**

**WAGENSCHUTZ LAWN  
SPRAYING**  
**THE LAWN SPECIALISTS**  
898 S. Main Street  
Plymouth 453-1576

- Fertilizer — Granular or Liquid
- Crabgrass & Weed Control
- Fungus & Insect Control
- Aerating

Early Bird Special — 18% Discount

**WEIGHT CONTROL**

**WANTED: 100 People We'll Pay  
You To Lose Up To 29 Pounds  
In The Next 30 Days!**  
Doctor Recommended  
100% Natural - No Drugs  
**WEIGHT LOSS CONSULTANTS**  
598 N. Mill Street  
Plymouth - Old Village

Donna 453-7802 or 427-2877  
Bea 453-2970 or 422-0412

**WINDOWS**

**WESTON WINDOW  
REPLACEMENT**

595 Forest, Suite 7B  
Plymouth 459-7835

PELLA — the finest quality replacement  
windows and doors. Enjoy the warmth  
and beauty of wood. Energy efficient vinyl  
windows and ANDERSEN windows.



# Sports

## Foul breeds controversy

### Chiefs ousted by Rocks in final seconds



#### Step aside

Salem's Wendy Bailey managed to get this shot off despite Susan Ferko's best efforts to deny it. At right, Jill Estey prepares to sink the game-winning free throws. (Crier photos by Chris Farina)

**BY JANET ARMSTRONG**  
Previously ranked fifth in the state, Canton girls basketball's brilliant 19-2 season has ended.

"You hate to see a referee decide the outcome of a game," said Canton coach Rob Neu referring to the Chiefs' loss to Salem in the districts on Saturday, 35-33.

Salem, now 17-4 on the year, played Northville last night in the district final. Salem coach Fred Thomann credits sound strategy for Saturday's victory.

"We had to keep the ball out of (Chief Susan) Ferko's hands," said Thomann. "We had to make sure we made our shots early."

Thomann said it was a big win for the Rocks and attributed the victory to a disciplined game plan. "We did what we had to do to win," he said.

Controversy and drama marked the game when, with no time left on the clock, a foul was called against the Chiefs. This sent Salem's Jill Estey to the line with the score tied 33-33.

Estey nailed both shots to clinch the first round of districts for the Rocks. She was also the game's high scorer with 12 points.

"The call was questionable at best," said Neu, who added a note of praise for Salem. "They stuck to their game plan. They played a better game. I think we were all a little guilty of looking forward too far."

"It was a very satisfying season," added Neu.

Canton loses four players to graduation; Michelle Fortier, Candi Jones, Amanda Bell, and Marnie Smith. Saturday's high scorers Ferko and Stacy Thompson, both with 11 points, will return for the 1989 campaign.

Thomann said Salem must keep on top mentally if they hope to go far in post season play.

"We have to forget about the emotion we spent against Canton," said Thomann. "It's business as usual."



#### After four games

### The fight is on in PCJBA

With four games down, the strongest teams in the Plymouth-Canton Junior Canton Basketball Association are beginning to emerge.

In the Girls A League, the Celtics have moved into the lead with a record of 3-1. The Kings and Lakers, both 2-2, are deadlocked in second place, while the Suns have fallen into last place with a record of 1-3.

Last week, the Celtics downed the Lakers, 38-18, and the Suns, 33-22. In other action, the Kings stopped the Suns, 21-20. The Kings went on to lose to the Lakers, 33-30.

In the Boys A League, the standings battles remain close.

The Bulls and the Pistons, both 4-0, are locked in a tie for first place in the National Division. They are followed by the Jazz (2-2), the Bucks and the Nets, both 1-3, and the Knicks (0-4).

In the American Division, the Rockets and the Suns share lead with identical records of 4-0. They are followed by the Kings (2-2), the Celtics and the Spurs, both 1-3, and the Lakers (0-4).

In recent action, the Celtics beat the Spurs, 53-51; the Suns downed the Clippers, 86-69; the Rockets downed the Kings, 75-53; the Nets edged the Knicks, 48-46; the Pistons stopped the Bucks, 73-59; and the Bulls nipped the Jazz, 40-39.

### Palastra tumbles to first

The Class III compulsory team from Palastra Gymnastics tumbled their way to a first place trophy on Nov. 13 at Genessee Valley in Flint.

In the meet, the Juniors earned four of the top five medals in the all-around competition. Lori Trussler took top honors with a score of 34.20. She was followed by second place finisher Autumn Bunch, fourth place finisher Kim Lewke, and Kim Rennolds in fifth place.

Dawn Klee earned first place honors in the uneven bars and the all-around competition.

In the Children's competition, Erin Ryan captured second place on the balance beam, while Brie Wall took third place in the floor exercise.

Overall, Palastra's Class III team won 41 ribbons and medals. The State Championships began on Saturday in Rochester. Palastra qualified a record 17 girls for the state competition.

## Rocks land in sixth

# Canton tankers stroke to second in WLAA

BY RITA DERBIN

Their finish was not first, but it was "commendable," according to coach Hooker Wellman.

The Canton girls swim team finished their conference season with 180 points and a second place finish behind Northville (262 points) at the Western Lakes Activities Association (WLAA) conference finals last Friday at Salem.

The top five was completed by Livonia Churchill, North Farmington, and Farmington.

The Salem Rocks finished in sixth place with a total of 121 points.

The Rocks tankers finished in third place in the 200-yard medley relay with 1:58.19, just under the state cut time of 1:58.59. Erin Olson took a fourth in the 100-yard breaststroke, just missing the state cut time of 1:11.69 with a 1:11.77 time.

"In our conference, any one of four teams -- Northville, Canton, Livonia Churchill or North Farmington -- could have won. But Northville was too strong for the rest of us," said Wellman. "They are a well-coached team whose depth balanced out every team in the league."

Several Chiefs qualified for the state meet Dec. 2 and 3 at Michigan State University.

Nicole Drake qualified for the state meet and had the lone first place finish for Canton in the 200-yard free style with a winning time of 1:58.73. Drake also qualified for the state meet in the 500-yard free style (second, 5:13.63), and the 400-yard free style relay race.

Cassie Cummins also was a multiple qualifier for the state meet by finishing



## Speed freak

Canton's Cassie Cummins muscles her way through a race during the WLAA conference meet on Friday. (Crier photo by Jason Bennett)

fifth in the 200-yard individual medley (2:17.70), second in the 100-yard backstroke (1:03.02) and third as a member of the 400-yard free style relay team.

Wellman said he was very pleased with the efforts of both relay teams. The 400-yard free style relay team of Kelly Rische, Cummins, Drake and Lori Engelhuber qualified for state with a time of 3:46.84 and the 200-yard medley relay of Jean McLenagh, Val Gildhaus, Chris Lang and Tammy Santomauro finished sixth, although

their time of 1:59.24 qualified them for the state meet.

Engelhuber also qualified for state in the 50-yard free style (third, 25.74).

She put in a strong performance by finishing in fifth place in the 100-yard free style with a time of 57.07, but did not qualify for states.

And Amy Van Buhler qualified for states with a 309.60 points and a sixth-place finish.

Chris Lang also swam well for the Chiefs by finishing in sixth place in the

100-yard butterfly (1:04.25).

Looking ahead to the state meet, Wellman said he thinks that his swimmers should do well. He said he feels that the 400-yard free style relay team should finish in the top 12 and his two top swimmers, Drake and Cummins, to finish high in their events.

Drake, who finished third in the state in both the 200- and 500-yard free style races last year, has her work cut out for her, according to Wellman. He also said he feels Cummins should do fine in all her events.

## Racquetball's a big hit

The Canton Department of Parks and Recreation is sponsoring a mens racquetball league to begin on Nov. 30.

Played at Rose Shores of Canton, league court times will be 7:30 p.m. and 8 p.m. The league will be divided into divisions based on ability.

Cost for the 13-week season is \$82. For further information call 397-5110. Register in person or by mail to: Canton Parks and Recreation Department 1150 South Canton Center Road, Canton, MI 48188.

## Canton aerobics extended

For an added fitness feature, the Canton Department of Parks and Recreation is sponsoring a fall extension of its aerobics exercise classes beginning Nov. 29.

The fall extension lasts for four weeks at a cost of \$16 for two weeks. Baby sitting is available for a small extra fee. Class times are Tuesday and Thursday mornings at 9:30 to 10:30 a.m. and a low-impact class at 10:30 to 11:30 a.m.

Register in person at the Recreation Department on 1150 South Canton Center Road.

For further details call 397-5110.

## WLAA honors CEP players

While the Salem High School Rocks and the Canton High School Chiefs have dominated the girls basketball standings in the Western Lakes Activities Association (WLLA), individuals from both squads have been recognized for their outstanding play in the conference.

Salem senior Jill Estey and Canton's senior Michelle Fortier and junior Susan Ferko collected WLLA 1988 All-Conference honors.

Canton seniors Amanda Bell and Candi Jones were named to the 1988 All-Western Division Team. Terri King, a Salem senior, was named to the 1988 All-Lakes Division Team.

Canton junior Jenny Russell and Salem sophomore Sarah Rueti were given honorable mentions in the Lakes and Western divisions.

## Second joint meeting Schools, officials to meet

BY DAN JARVIS

A second joint meeting between the Plymouth-Canton Community Schools and local units of government from the City of Plymouth, Plymouth Township and Canton has been scheduled for Wednesday, Nov. 30.

David Artley, school board president, said representatives from the the school administration and board of education, the City of Plymouth, and both Plymouth and Canton townships confirmed attendance for the meeting.

On the agenda, said Artley, is a discussion of the sale and purchase of property, new recreation plans, tax abatements and warehouse purchasing.

The same items were on the agenda

for the first joint meeting, held last May, which helped pave the way for sale of the Barchester property from the schools to Canton.

Artley said another joint meeting was needed to help newly elected officials in local government get to know each other and school representatives.

"If we can form a common understanding and work together to achieve some efficiencies," said Artley. "We can benefit the citizenry."

"Whatever we get is more than we have now," he said.

The meeting will take place Wednesday, Nov. 30 from 7-9:30 p.m. in Canton High's Little Theater.

## Sommerville gets 'miler'

For more than 31 years, Max Sommerville has been teaching science and math at Smith and Allen elementaries and at Central Middle School.

For his positive attitude and willingness to make extra efforts, Sommerville has been awarded the "Extra Miler" award by the Plymouth-Canton Board of Education.

He began his career with the district in 1957 and holds a BA from Central Michigan University and a MA from the University of Michigan.

Along with a framed certificate, Sommerville was awarded a pin of the Flag of Liberty and Learning and a certificate for brunch for two at the Mayflower Hotel.

## Victorian antiques

# Museum holds exhibit

Dollhouses, miniatures, antique toys and much more are all part of the Victorian Christmas celebration at the Plymouth Historical Museum.

As part of a special exhibit, the Wee Bees Miniature Group of Birmingham is exhibiting a collection of miniatures and the club's large dollhouse all decorated for the holidays.

During the holidays the museum will be open on Dec. 19 through Dec. 23 and again Dec. 27-30 from 10 a.m. to 4 p.m. Admission is \$1 for adults, 50 cents for youths 12 to 17 and 25 cents for children five through 11.

For further information call the museum at 455-8940.

## Chuhran sees election abuse

BY KEN VOYLES

Outgoing Canton clerk Linda Chuhran said she was both astonished and disgusted by the public abuse leveled against election workers during the Nov. 8 general election in the township.

Chuhran said approximately 250 workers were involved in the election process on that day, both at the precincts and in the main township office.

"The abuse taken from residents was astonishing and disgusting," she told the board during last week's regular meeting. She added that at one

point members of the public were seen throwing wads of paper at a worker on the phone.

"A lot of those workers are seniors and they are very dedicated," Chuhran said. "The abuse they had to take was just totally uncalled for."

Chuhran claimed that residents of Canton did not prepare themselves well enough for the vote on election day.

One resident spoke to the issue during the same meeting, requesting the board consider looking at precinct boundary changes before the next election.



The  
Community Crier

## Do you have what it takes to fill these shoes?

Are you special? Do you like meeting a challenge and making money? If you do, we have just the opportunity for you. Be a Crier Carrier and learn to take on responsibility and make your own money.

Hurry and call us today. There are a limited number of routes available and one could be right in your neighborhood!

**Call Today! 453-6900**



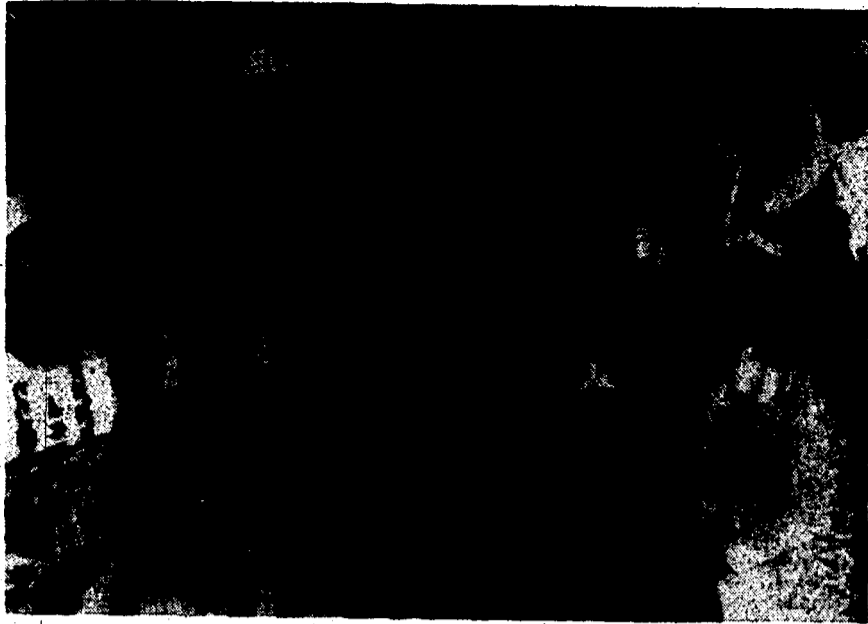

## Celebrating...

Celebrate merry olde England at 7 p.m. on Saturday, Dec. 17 when the Livonia Symphony presents a special holiday evening featuring music at Madonna College. Entertainment includes the Silver Swan Singers of East Lansing, the Livonia Brass Ensemble, medieval instrumentalists, dancing, Wassail toasts and Christmas caroling. Featured menu items include whole cornish hens with apple dressing and plum pudding. Tickets are \$27.50 per reveler, with tables of six to 10 reserved at a discount. For information call 591-5046 or 522-7846.

## Dellamar gets abatement

BY KEN VOYLES

Dellamar Manufacturing Company won approval recently for a 12-year, 50 per cent tax abatement from a reluctant Canton Board of Trustees.

The board approved the abatement 4-2 with Elaine Kirchgatter and Linda Chuhnan voting against the abatement.

"This is a typical kind of request," said Dave Nicholson, director of Canton's Economic Development Corporation.

There are currently no site plans for the project, according to Treasurer Gerald Brown, who added that the project is worth an estimated \$1 million.

The Dellamar abatement fits into the current board's plans for the northeast corner of Canton, said Trustee Loren

Bennett, who added that the board "guaranteed" abatements in that area back in 1985 to help draw businesses to the township.

"I think we're still operating under that obligation," said Trustee Bob Padget.

Brown added that the new board may have to look at that section of Canton — known as the Northeast Canton Industrial Development District — and decide whether or not to continue to guarantee abatements there.

"A lot of people think we've given away millions in abatements," he said. "It's not true. We've only given 18 or 19 companies abatements."

Kirchgatter said she voted against the abatement because she is opposed to a 12-year agreement.

## Girl Scouts need volunteers

The Huron Valley Girl Scout Council is seeking volunteers to "take the lead" in the Girl Scout tradition, including parents, professionals and senior citizens.

Volunteers are needed as program consultants, committee members, event directors, media reps and troop leaders.

More than 1,200 Plymouth-Canton girls are involved in the Girl Scout program.

For information on volunteering time to help the Girl Scouts call 483-2370 or write the Huron Valley Girl Scout Council, P.O. Box 539, Ypsilanti, MI 48197.

\$3.50 for the first 10 words. 10¢ each additional word. Deadline Monday, 4 p.m. Call 453-6900

# Crier Classifieds

### Curiosities

P.D. GRAHAM

Join us on December 3rd for our 7th Annual Craft Show (in Westland)

Wanted Crafter!! For table rental & more information call Chris at 595-8781.

CHRISTOPHER & MATTHEW WEBB: I know when you're bad or good! I have my eye on you two! — Santa Claus

"LUCK IS A BIRD that hops from shoulder-to-shoulder." — Howard Hunt, visiting Canton, 1988

EAGLE RIVER, WISC. is off and running! Beardstown, IL is next.

Thanks should be given at least once a day. — Not just once a year.

JESSICA eats dedication cookies. at Hoben Elementary and Riffle's soup.

DR. REHNER: we'll miss your vision of the world. Happy retirement! — Clients and Friends.

Q: What's new for families to do in Plymouth-Canton and only costs \$5?  
A: Wednesday Night Family Skating at Skatin' Station 6:30 - 9 pm

HoneyBunny: I'll have your tube steak anytime! Your sauce is the best! — JamBunny

Dan — go ahead, say it, the suspense is making me nervous — like waiting for the other shoe to drop.

Kay Fisher — Your generosity is eclipsed only by your kindness. Thank you for your help. Karen.

KEN BAKEWELL: we hardly knew ye - we already miss you. (We'll bring Rolling Rock if we get up there.)

OHIO, OH WELL. — A Gator-bound U of M rooster.

She! — No matter what the final score is — you will always be a winner!

THANKS LARRY — the ducks were stuffed and so were we. — Ed

VISIT THE NEW Canton Library. It's beautiful.

### Curiosities

Q: What's new for Moms, Dads & Tiny Tots to do in Plymouth-Canton?

A: The Animal Cracker Skate Wednesday mornings 9:30-11 am at the Skatin' Station.

MATT NORRIS and CRAIG BRASS — great Gator-tail — gating with you! — Your ticket-less friends. Thanks! (Beverly, my Dad will give you your socks back.)

I wonder why S.L. didn't wear ear rings Thurs., H.T. was very disappointed.

Jack — You're supposed to turn the lights off FIRST!

CARL GLASS: urgent! please, don't call, just show up for the tar and feather party.

THE TURKEY BOWL will be held at Noon, the old High School, this Friday. Football at its finest!

Michelle Wilson — A sincere thank you for all your help & resourcefulness last week. Karen.

Was that Santa I spotted in Ply. last week? I wonder if he was doing his holiday shopping?

MIKE CARNE: where are the "basement" tapes? (Do houseboats have basements?) — Mark from Naples and the Volga Boatman.

Grandpa — Happy Birthday! Have a sunshine day! — Love Julie

CHRIS JOHNSTON throws wounded ducks? Who cares as long as your own guy catches it! Congrats C.C.

EXACTLY 10,000 FOLKS can be wrong.

Dad — Another year younger? Have a great day! — Love, Gary & Peg

76,000 FOLKS got so carried away at Phyllis Redfern's 45th birthday that they tore down the goalpost.

SEE KEN — over 30 is not so bad.

IRMA — The Turkey Dinners in the hospital aren't as good as "home cooked." Hurry up & get well quick! With love & best wishes from your relatives in Mich.

### Curiosities

Andrea — You survived your first shopping experience with us. Congratulations! — P. & J.

Give me a — M-I-C-H-I-G-A-N! What does it spell? Trouble for USC!!

I would like to thank Ed & Fred for their donation to my favorite cause, upgrading my standard of living.

Julie — I think we broke our own record on Sunday! — Mom

Gary — Good party Saturday night. Great idea!

Rebecca, Rec-a-Beck, Baby Bocca, Bucko, Bec, Becca, Bocho - are you having an identity crisis? Hope you have a happy 17th birthday instead! Love, Mom, Dad, George, Mike and Brandy.

H.T really looks up to S.L.

Ken went over the hill on Sunday and was still able to make it to work on Monday. Amazing! Happy "three-o" Ken.

Happy Birthday Janet Hundley!

BEAUREGARD eats sausages from Karl's

Debbie, the cake was great! I will try not to make remarks about your cooking. — until next time. Mom

Michigan State — 2nd Best in the state & the Big Ten. Not bad for farmers.

Jack almost lost his bet Saturday — will it make him nervous on bowl game bets?

M.R.S. — My time with you is never spent — my time with you is shared. Thank you for being my friend.

Kevin K. — Surprise! Surprise! Now you can keep up on all the latest news. (Hi Bret and Kevin Z.I)

"Share a Hug"

Arlie — Yes you will recover from this weekend. Your agility and speed puts your friends in awe of you. Meanwhile Taurus is able to put a little weight on her ankle & she should recover. Always keep in mind the saying, "Wait till next year."

Oh good. Long ear rings will make my life easier.

### Curiosities

Ken Voyles, how does it feel to be over the hill?

HAPPY BIRTHDAY BILL BAXTER. I won't tell how old you are (at least for another two years).

Hank & Deb, thanks for the beautiful flowers. Phyllis

It may have been rainy and cold, but it was a fun football game. Way to go MSU.

Jim Cantrell, remember to cook the turkey right side up.

Paul likes the new Ad Rep. She is shorter than him.

Shirley — Thanks for all your help this week. It was great to have you back!

Happy Birthday Santa Don Montgomery — from the elf who shares the same birthday.

To bad John didn't bring some of the good FLA. weather up with him.

Perhaps one of the Biggest Joys of this life; is to know that we are not alone, that many events and things common are a shared event. Somewhere in the time continuum concurrent days roll by in yearly procession and even the years of first Breath; there is this excitement that someone else shares your Birth date. I would like to take this Moment in time to wish US a Happy, Joyous, Properous Meaningful life; Not only now, but also in that spiritual continuum Eternity. God Bless Us — Don Montgomery

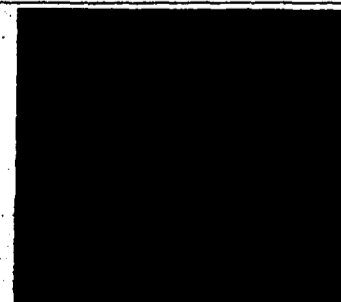

Cheryl Hamernik  
Happy 20th  
Love, Mom & Dad

MONDAY, NOVEMBER 23, 1988  
 Monday, November 23, 1988

# Crier Classifieds

## Curiosities

THE DETROIT LIONS prove that even a blind dog finds a bone once in a while.

Taurus — this week will be filled with friends and relatives sharing good times. Look for a new start in Jan. '89. Be sure you don't forget Cancer.

PAUL McCORMICK: was that you pulling down the goal post?

PAUL SEMPERGER: when is the next bald-headed, bearded night at the bar?

"HIS.L." H.T.

Shirley — Why are you pointing down your throat?

My Christmas tree mug is special and so is my Raggedy Ann ornament, — almost as special as the friends who gave them to me — thanks.

Jayne — You would have loved my memo on Monday. It was a great way to start the week! — Peg

## Situations Wanted

Sharp, professional couple needs house-sitting situation, few months to longer, start date negotiable. Neat, clean and responsible non-smoking Christians. Address inquiry to P.O. Box 3506 Ann Arbor, 48106.

## Mich-CAN Statewide Ad Network

"ATTENTION - GOVERNMENT SEIZED VEHICLES from \$100. Fords, Mercedes, Corvettes, Chevys. Surplus Buyers Guide, 602-838-8885 ext. A-11027."

THE HUNT-IS ON! Do you have the ambition and aptitude to become a professional crosscountry truck driver? Bowling Green, Vo-Tech in Bowling Green, Kentucky can teach you in just three weeks, on the same type of equipment J.B. Hunt uses. Tuition is \$850. Financial assistance is available. And J.B. Hunt regularly hires graduates. Must be 23 or older. 1-800-643-3331.

GOVERNMENT SEIZED SURPLUS AUTOS. Low as \$100. Cadillacs, Porsches, BMW's, Mercedes, Chevrolets, Fords, plus trucks and vans. Amazing 24 hour recorded message reveals details. 312-301-2418.

"ATTENTION - HIRING! Federal government jobs in your area and overseas. Many immediate openings without waiting list or test. \$17,840 - \$69,485. Phone call refundable. 602-838-8885 ext. J-11027."

GET RESPONSE TO YOUR CLASSIFIED AD! Advertise in the Mich-CAN Statewide Ad Network and reach a 1,219,000 circulation. 25 words for \$300.00. The Community Crier costs \$900 and ask for your advertising consultant today.

## Curiosities

Scratched and dented bifold doors — All styles and sizes. Save \$\$\$ at Carter Lumber 665-5531.

## Services

NO TIME? HATE TO SHOP? Let us do it for you! TIME SAVER SHOPPING SERVICE. 397-9589.

HOME IMPROVEMENTS AND REPAIRS OF ALL KINDS. NO JOB TOO SMALL. LOCAL REFERENCES. FREE ESTIMATES.

DON THOMA  
 PHONE-CANTON 961-0857

Do you need a handyman? Someone to hang wallpaper? Call RJ 961-4844.

J. RIGBY BOYCE  
 PAINTING CONTRACTORS  
 Residence and commercial, inside/outside. Free estimate. Call us 453-0807.

H and K Painting. Interior. Insured. 453-8123 or 427-3727

Lamberto Construction, all types cement work. No job too big or small. Free estimate. Licensed. 455-2925

HAND K HOME REPAIRS  
 OF PLYMOUTH-CANTON  
 Small jobs, carpentry, electrical, plumbing and painting. Insured. Bob 495-0113.

BATHROOMS RE-CAULKED — CARL GLASS 420-3227.

TONY'S TREE SERVICE trimming, topping, removals & stumps. 25 years experience. FREE estimates. 420-0550 or 420-0712.

CUSTOM DRAPERIES BY CAROL  
 Nice fabric line — Balloons, Austrians and Cornice boards. 422-0231

Alterations — Dresses Remodeling — major and minor repairs. 25 years experience. Call Aurora, 453-4180, or will come to your home by appointment.

PLASTERING  
 Specialist in small water damage & repairs. 35 years experience. Call Roy 458-7197.

HOME REPAIRS, DECKS, SUNROOMS, ROOFS. JAMES DUNN CONSTRUCTION. 455-6384.

WALL PAPERING  
 Excellent work, Prompt installation, Reasonable Prices.  
 Nancy: 453-1164  
 Barb: 455-1348

FALL CLEAN UP AND GUTTER CLEANING. Call for estimate on fall clean up. Gutter cleaning, 13¢ to 18¢ per ft. plus service charge.  
 Green Ralnger Landscaping. 453-9353.

Quality legal services at affordable prices. Uncontested divorce, (no children, no property) \$385. Divorce (with children) from \$825. Drunk driving, from \$350. Drivers license restoration: \$365. Bankruptcy, from \$650. One simple will: \$80. Court costs additional. For fee consultation call Attorney Gary Lentz 313-347-1755. Offices located in Novi.

FULL TIME MULTI-LIST REALTOR, A HOME FINDING PROFESSIONAL, WILL ASCERTAIN YOUR NEEDS AND AFFORDABLE DESIRES AND ASSIST YOU IN YOUR HOME BUYING ENDEAVORS. MY CAR, SERVICES, AND UNDIVIDED ATTENTION ARE AT YOUR DISPOSAL. CALL 453-1007 CITY-COUNTRY REALTY & ASSOC.

General housecleaning — reliable, thorough, reasonable. Done to your liking. Great references. Evenings 397-9600 or 961-5449.

ATTENTION  
 For Sale By Owner  
 THE HOME BOX AND THE HOME BOX HOME HIGHLIGHT SHEET are here! Let them make marketing your home easy. For rental information call HOME BOX, INC. 313-458-2388.

GREAT ANNUAL ESTATE SALES AND HOUSEHOLD LIQUIDATORS, SPECIALIZING IN THE PLYMOUTH-CANTON AREA. CALL SUE 453-3441 or BARB 457-0877.

## Moving and Storage

LIDDY MOVING Senior discount. In-home free estimates. Plymouth warehouse. Licensed and insured. 421-7774

For Lease — secure, climate controlled, storage space. 2200 sq. ft. with overhead door. Long or short-term lease available. For info call National Mini Storage. 458-4400.

## Sharpening

BOB'S SHARP-ALL  
 Complete Sharpening Carbide, steel saws lawn and garden items  
 Gas/Electric Hedge Trimmers  
 8445 Canton Center 451-0589

## Home Improvement

Lornac Construction, Complete Home Modernization. Kitchens, baths, rec rooms, bars, custom decks. Hardwood finish carpenters. Glen McIntosh 453-7751 Don Lorence 326-7186.

## Entertainment

MAGIC AND COMEDY  
 for CHILDREN AND ADULTS  
 PARTIES, BANQUETS, PICNICS & more.  
 CALL Mike Thornton at 453-4562

Professional radio D.J. for all occasions, music from the 40's through the 80's. Cary 487-4126.

## Photography

PHOTOGRAPHY BY JOYCE  
 455-1910

RAWLINSON PHOTOGRAPHY  
 Specializing in Weddings and Family Portraits  
 453-8872

## Lessons

Evole Music  
 Now Open in Plymouth  
 Piano's, Organs, Keyboards  
 Band Instruments and Accessories  
 Sheet music and Books  
 Sales, Lessons and Service  
 215 Ann Arbor Rd., Plymouth  
 455-4877

ART LESSONS  
 All media, all ages, all FUN!!  
 Call today, 455-1222 The Art Store  
 Plymouth

PIANO-ORGAN-VOCAL  
 LEAD SHEETS-ARRANGEMENTS  
 MR. PHILLIPS  
 25 YEARS EXPERIENCE  
 FORMERLY WITH ARNOLD WILLIAMS  
 453-0108

PIANO, ORGAN & VOICE LESSONS IN YOUR HOME. DAN OR CAROL. Bachelor of Music Degree & Bachelor of Science in Education 721-8135

## Crafts

COUNTRY FOLK ART SHOW  
 LADBROKE DRC  
 28001 Schoolcraft (I-96) Livonia, MI.  
 NOVEMBER 25, 26, 27  
 FRIDAY 11AM-6PM  
 SAT. & SUN. 10AM-6PM  
 Over 100 craftsmen selling Victorian and Country needs and gifts for the holidays. One reduced entry with this ad.

## Articles For Sale

Yamaha Razz '87 \$300 or best offer. Call 453-9287

Lady Kenmore electric dryer. Excellent condition. \$175 Phone evenings 458-4134

Aluminum storm windows and screens — all sizes and frames only. 458-4134

## Vehicles for Sale

GOVERNMENT SEIZED Vehicles from \$100. Fords, Mercedes, Corvettes, Chevys. Surplus Buyers Guide (I) 865-887-8000 Ext. S-4535

1980 A.M.C. Spirit. Good condition. Best offer. 458-6488

## Child Care

Child care in my licensed Plymouth home. Loving care. Ages 1-5 preferred. Call evenings. 459-2578

## Pets

FREE Healthy Puppies. Mother AKC Golden Retriever, Father Black Lab. 453-1745.

DO YOU NEED SOMETHING CUTE TO CUDDLE? I have three 6 week old, long haired, miniature dachshunds for sale. Call 455-2232.

## Business Opportunities

PLY. PRIME MAIN STREET LOCATION 5,000 SQ. FT., GREAT INCOME. 455-3689.

Retail Space \$200 per month. Call 648-0271

## Office Space For Rent

PLY. PRIME MAIN ST. LOCATION. 900 SQ. FT. GENERAL MEDICAL, UTILITIES INCLUDED. 455-3689.

## Business Space For Rent

Space for lease — prime downtown Plymouth location. New carpet, freshly painted. Includes utilities except telephone. Call 459-1080.

## Apartment For Rent

Ply. 2 bedroom duplex. Garage, appliances, carpet & curtains. \$825.00. Includes all utilities. Canton one bedroom \$395.00 two bedroom \$485.00. 455-0391

## Homes For Sale

GOVERNMENT HOMES from \$1 (U repair) Delinquent tax property. Repossessions. Call (I) 805-887-6000 Ext. GH-4535 for current repo list.

## PLYMOUTH NOW LEASING

OFFICE/RETAIL  
 SPACE AVAILABLE  
 I-275 and Ann Arbor Road

Plymouth Atrium Center  
 Retail Stores from 600 sq. ft. and up.  
 Office suites from 1000 sq. ft. and up.

Plymouth Office Plaza  
 Offices start at 660 sq. ft. and up.

Call  
**PATRICIAN** 459-9111



## DESIRABLE DOWNTOWN PLYMOUTH!

Invacuable home in excellent condition. Home has potential for 3rd bedroom — upstairs ready to be finished. New carpet, neutral decor, Hardwood floors & wet plaster construction. Detached garage.



## NEW CONSTRUCTION IMMEDIATE OCCUPANCY

In popular Sunflower Sub. Custom brick w/char. trim. Colonial over 2100 sq. ft. w/great rm. concept w/cathedral ceiling & nat. l.p., 2 1/2 baths, 3 bdrms. w/den or could be 4th bdr. Call for more info!

Ask for Mary, Gert or Kathy  
 NoMax 459-3688

\$3.50 for the first 10 words, 10¢ each additional word. Deadline Monday, 4 p.m. Call 453-6900

# Crier Classifieds

## Bands

**HyTimes**  
Great band for weddings and special events. Hear and see us in action. 453-2744

## Firewood

Absolutely all seasoned 1 year, choice split mixed hardwood. \$80.00 a facecord, 2 or more \$55.00 each. Free delivery. 464-2433.

## Firewood

Driveway Delivered Special — Seasoned Hardwood \$55.00, White Birch \$85.00, Kindling \$3.00 a bundle — top quality — 349-3219

## Lost & Found

WAS OUR MAIL DELIVERED TO YOU?  
Nancy & Mel Bobcan. 455-2889.

## Employment Market

### Help Wanted

#### KIDS THRU SENIORS

The Crier is now looking for carriers on many routes! If you are interested in a money-making opportunity, call Craig at 453-6900.

Car cleaning — part-time full-time positions. Experienced, \$8-8 hour. Also willing to train. Plymouth. 420-2224

#### HAIR STYLIST

to work in antique barber shop. Experienced in perms, etc. Some clientele preferred. Call 453-5020.

**IF YOU CAN SELL, YOU SHOULD BE TALKING TO US.** We pay a commission on everything you sell. We pay a salary plus commission. Great hours and working conditions. Full time salesperson (40 hrs.) can earn \$30,000 +, part-time also needed. Start time 1-2-89. P.O. Box 87064 Canton, MI 48187

Snow Busters Snow Removal, Inc. is a growing organization looking for snow plowing drivers, with or without trucks, 18 or older. Must have 2 years experience and be responsible & dependable. Can earn up to \$45.00 an hour. Call Snow Busters 453-9353

#### HELP!

I need 6 full-time and 10 part-time people for my business. Full training, start now. Call between 10am to 2pm. 473-9062.

#### \$ \$ \$

Add to your income — work Friday/Saturday in your local supermarket passing out food samples. Must have reliable transportation & like people. Call 846-7093 Mon. through Thurs. 10 am to 4 pm for interview.

#### CRUISE SHIP JOBS!

Immediate Openings! Seasonal & Career opportunities. Excellent pay. World Travel! Call (Refundable) 1-518-458-3535 EXT. P4562.

Desperately seeking driver. Needed every Tuesday - early evening. Own transportation, mature, dependable only need apply. Call Phyllis 453-6900.

Full time office position available in our circulation dept. for fun loving, outgoing individual. Must have good phone skills. Experienced or will train. Join The Crier staff! Contact Peg — 453-6900.

Receptionist — Westland office. Start \$180 a week. No experience necessary. Must be 18 and work well with people. Call Ashley 427-8335

**HOME WORK — Spare Time.** Paint lovely folk art building shapes which form toy village of houses, library, town hall, etc. No experience necessary; have entire family help you. We pay you \$20 for each set of 11 toys painted according to instructions and reimburse your shipping costs. Send us 5 set weekly, earn \$100. Send us 10 sets weekly, get a check for \$200. Our homework starter package includes all the objects in the toy village and color scheme for each part. To register into program, send your name address, and \$20 registration fee (refundable on second set of painted toys you send us) to: Daniel Rowan, 3 Golf Center, Suite 308-5930, Hoffman Estates, IL 60195

**AIRLINES NOW HIRING.** Flight Attendants, Travel Agents, Mechanics, Customer Service, Listings. Salaries to \$105K. Entry level positions. Call (1) 805-687-6000 Ext. A-4535

### Help Wanted

Barber-Stylist, Mel's Golden Razor 455-9057, 455-2889 after 7. Male or Female.

**GOVERNMENT JOBS \$16,040 - \$59,230/yr.** Now Hiring. Call (1) 805-687-6000 Ext. R-4535 for current federal list.

#### SALEPERSON WANTED

Full or part-time hours available. Pease Paint and Wallpaper, Plymouth, MI Call Mr. Laxer at 453-5100.

**EARN MONEY Reading Books!** \$30,000/yr. Income potential. Details (1) 805-687-6000 Ext. Y-4535

Daytime help wanted for playroom in bowling center part-time. Ask for Sandy or Judy 459-6070

Wanted — Night custodian/watchman for bowling center. Call 459-6070 ask for Sandy or Judy.

**HELP WANTED FULL TIME — DAYS.** Apply in person at: Main Street Auto Wash, 1191 S. Main, Plymouth — 455-9685

#### STAY HOME

#### MAKE \$400 WEEKLY

Helping local businesses process mail. GET PAID DAILY. To apply, send SASE to: United, 23704-5 El Toro Rd., Dept. 421, El Toro CA 92630

### Help Wanted

Full time office position. Must be good on phone and willing to learn circulation. Send resume to Phyllis at The Crier, 821 Penniman, Plymouth, MI 48170.

#### HELP!

I need 6 full time and 10 part-time people for my business. Full training. Start now. 453-7803 or 453-2970.

Babysitter needed in downtown Plymouth! Occasional evenings and weekends. Perfect for reliable high school student. Good pay — great kid! Call 454-1019

Dental business assistant. Part-time reception position available in progressive west Livonia practice. Experience preferred 464-2884.

Limosine drivers needed. 25 and older. Good driving record necessary. Call 455-4570

Carpenters & Laborers Needed. Experienced or willing to learn. Call 455-6384

**ATTENDANTS Male & Female.** Full & part-time openings. Apply at Colony Car Wash. 302 W. Ann Arbor Rd. — Plymouth, MI, or call 455-1011

### Help Wanted

**AFTER SCHOOL & WEEKENDS** part-time help — Apply in person at: Main Street Auto Wash, 1191 S. Main, Plymouth — 455-9685.

Carpenters, carpenters' helpers, experienced. Call 455-4375.

#### 16 YEARS OR OLDER

**IF YOU ARE INTERESTED IN DOING ODD JOBS PART-TIME FOR A SMALL PLYMOUTH BUSINESS** CALL — 459-5830

Journeyman and/or skilled painters only need apply. Call Gary 437-0631

Part-time Babysitter for two children. Joy/Haggerty area. 453-7258

**A Great Place To Work!**

**MICHIGAN'S LARGEST REAL ESTATE COMPANY**

Call Joe or Tricha at 455-7000

**Plymouth-Canton.**

Real estate's most complete training program

If you've ever considered a Career in Real Estate please call Nan.

**Century 21** 455-5880

SUBURBAN 188 N. Main Plymouth

**CLARK OIL**

Looking for full & part-time

**CASHIER CLERKS**

For our self-serve gas station. You must be honest, reliable, hardworking and willing to work any shift (6 am - 12 midnight). Must be 18 years or older and have own transportation.

**Apply Monday - Friday**  
6 am - 3 pm

Clark Oil  
44404 Ford Rd.  
Canton, MI





MEIJER

NOW HIRING!

OPPORTUNITIES NOW AT MEIJER!

Our new store in Ann Arbor opens next spring! We're hiring NOW to fill positions in the store. Tell us where you would like to work. We have positions open in everything from Bakery to Marking/Layaway and Grocery to Pet and Garden.

IMMEDIATE PAID TRAINING FLEXIBLE HOURS BENEFITS

Stop by our temporary employment trailers located in front of the store at:

3145 Ann Arbor/Saline Road  
Ann Arbor, MI 48103  
Call our Hotline  
(313) 663-8614

Opportunities also available at these Meijer locations:

3825 Carpenter Road Ypsilanti, MI 48197	45001 Ford Road Canton, MI 48187	14640 Pardee Road Taylor, MI 48180
--	-------------------------------------	---------------------------------------

IMMEDIATE INTERVIEWS

Equal Opportunity Employer



Join  
us

# at our Christmas Open House

9:00 - 9:00 Friday  
9:00 - 6:00 Saturday



WREATHS  
20'' to 4'  
natural and  
permanent

## DECOR & GIFT IDEAS



Custom Designed Arrangements



More Than 30  
Traditional to Modern  
Types of Santa Claus  
Ornaments &  
Center Pieces  
on Display

OPEN  
SUNDAYS  
til CHRISTMAS  
Noon - 4 pm



Visit our  
Greenhouse of  
Poinsettias

Charge By Phone:



flowers & gifts

Open 8:30 - 6 pm

995 W. Ann Arbor Trail  
(at Harvey) Downtown  
Plymouth

We wire any  where

(Please  
Order  
Early)



# 453-5140

# S & W PRO HARDWARE

875 ANN ARBOR RD., PLYMOUTH, MICHIGAN

PHONE: 453-1290



CHRISTMAS '88 PUB #2

## Christmas Specials

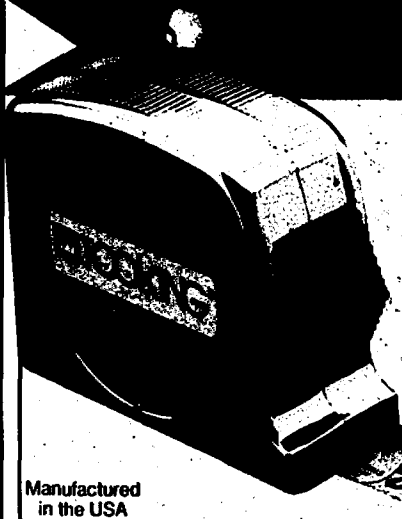

**TOOKING**

**1 IN. x 25 FT.  
TAPE MEASURE**  
Automatic return. Chrome  
finish case, with belt clip.  
Ultra rigid (2)(TK425)

**\$6.66**

**BARGAIN  
OF THE MONTH**

Manufactured  
in the USA



**MECHANICS  
TOOL BOX**

Heavy duty tool box.  
Features lockbolt, full  
length tray. 22-in.  
long x 8 1/2-in. high x 5 1/2-in.  
deep. (1) (189226)

**\$11.99**

**BARGAIN OF THE MONTH**



**\$12.99**

**MINI  
MAGNIFYER**

The best floodlight you'll  
ever own. Weighs less  
than 2 ounces and is 5 1/4  
inches long. Includes  
FREE "AA" batteries and  
belt holster. Features ad-  
justable beam from spot to  
flood. (6) (M2A014)



**\$19.99**

**CORDLESS  
RECHARGEABLE  
SCREWDRIVER**  
WITH FREE HOLSTER

Compact design, 3-posi-  
tion switch with "Touch  
Power." "Auto-Engage Shaft  
Lock" converts to mechanical  
screwdriver. (3)(9018C)



**Arvin**

**\$26.99**

**WALL  
HUGGER**

First direct wall plug-in heater with  
nightlight. Powerful 1000 watt por-  
table heater with fan. (5)(WH10)

**LIFESAVER**

**SMOKE  
ALARM**

5" diameter, 9-  
volt battery (includ-  
ed) powered, smoke  
detector. Five year ltd.  
warranty. U.L.  
Listed (4)(0905)



**\$5.99**

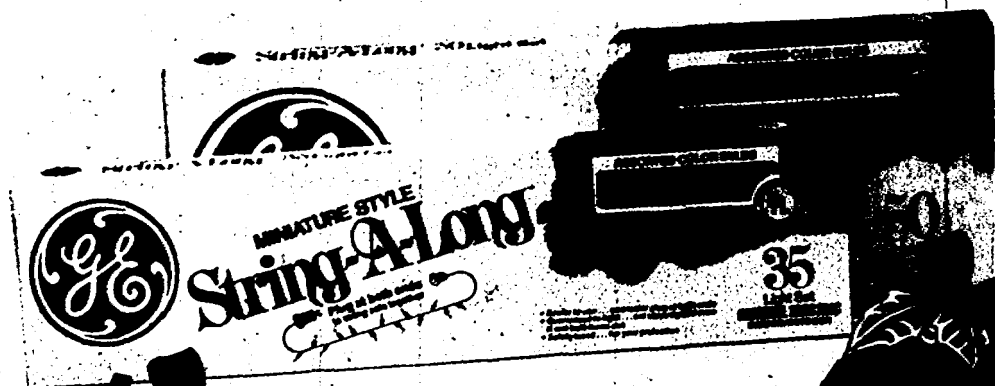

**Rebate**  
4.99  
-1.00  
**\$3.99**  
EAC-

**STRING-A-LONG LIGHT SETS**

Use indoors or out. Connector plug at both ends. Guaranteed to light. U.L. listed. Set of 35, 16 ft. cord, Assorted (11) (UXL2-35A), Clear (11A) (UXL1-35CL). Set of 50, 23-ft. cord, Assorted (12) (UXL2-50A), Clear (12A) (UXL250CL). \*See in-store coupon for details.

**Rebate**  
5.99  
-1.00  
**\$4.99**  
EAC-



**YOUR CHOICE**  
**\$9.99**

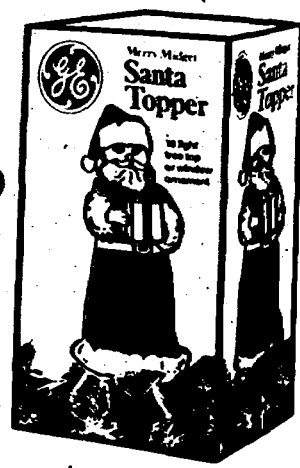

**ANGEL OR SANTA TREE TOPPER**

10-light ornamental tree topper gives elegant touch to any tree. U.L. listed. (8) (ATL2-10) (9) (STL2-10)



**Rebate**  
11.99  
-2.00

**\$9.99**

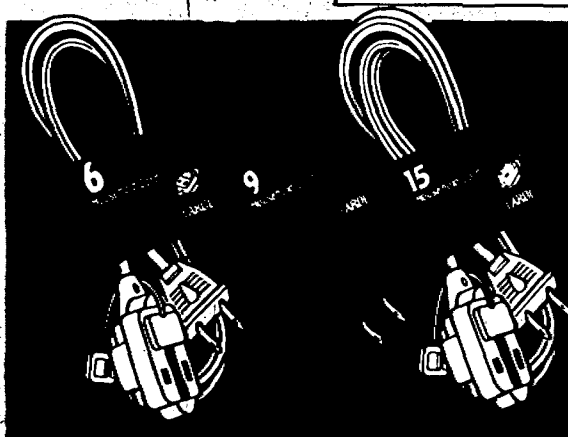

**15**  
Removable Switch Cord  
EAC-

**50**  
Outdoor Cord  
PREMIUM ALL WEATHER  
EAC-



IDEAL SECURITY  
HARDWARE

\$6.99  
203 (204)

### CHRISTMAS TREE STAND

Heavy-duty steel  
tree stands. Easy  
to assemble.

5-1/2" TRUNK  
For trees up to  
8 ft. tall.

(24) (104)

**\$11.99**

WERNER



### 2-STEP WOOD HOUSEHOLD STEPSTOOL

U.L. listed.  
(25) (25) (W 150-4)

**\$7.99**



**\$5.99** **\$7.99**

6-IN. ROUND (26) (38408) 8 IN. ROUND (27) (38408)

### SCHAEFER CHIMNEY BRUSHES

Clean your chimney  
yourself. Keep it safe.

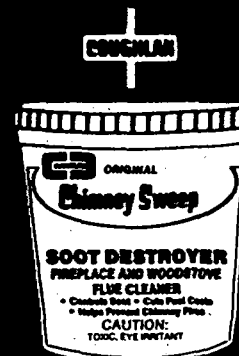
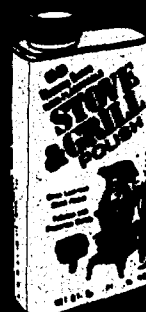

## SEYMOUR

From our hands to yours since 1872.

### 3-PIECE FIREPLACE TOOL SET

Traditionally styled polished  
brass finished shovel,  
brush and poker.

(29) (30-284).

**\$27.99**

### MATCHES & FIRELIGHTER GIFT SET

Beautifully designed box  
includes 60 nine inch  
long matches and thirty-  
six Fire-lighters which  
catch-on fire easily and  
burn up to 6 minutes.

(28) (30-582)

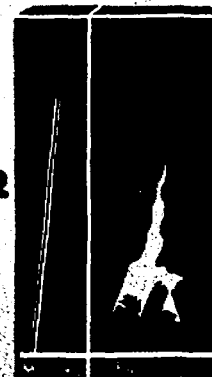

SEYMOUR

From our hands to yours since 1872.

**\$2.99**



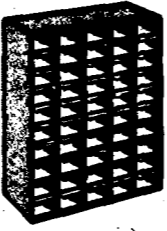
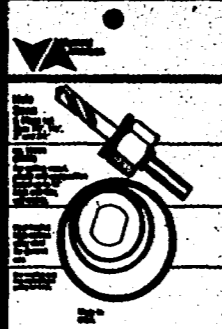
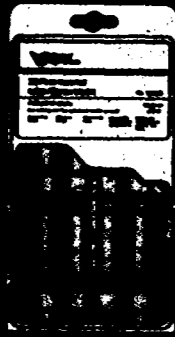

**21 DRAWER  
STEEL  
CABINET**

**\$12<sup>99</sup>**

(82) (11-521)

**50 DRAWER  
PLASTIC  
CABINET**

**\$9<sup>99</sup>**

(83) (10-350)

**FULLER**

**3-1/2 IN. VISE**  
Replaceable hardened  
faces, permanent pipe jaws,  
large anvils and horn, swivel  
base. (94) (1773)

**\$14<sup>99</sup>**

**FULLER**



**2-PIECE PROPANE  
TORCH KIT**  
(100) (TK10)  
**\$9<sup>99</sup>**



**STANLEY**



**\$9<sup>99</sup>**

**\$9<sup>99</sup>**

**SHORT CUT  
TOOL BOX SAW**

15-in., 9 point fast cutting saw.  
Built-in square and miter han-  
dle. (85) (15334SP)

**WORKMASTER  
6 PC. RATCHET  
SCREWDRIVER  
SET**

Features 3-position ratcheting  
mechanism, 3 slotted and 2  
Phillips bits. Bit storage in han-  
dle. (84) (68-750SP)

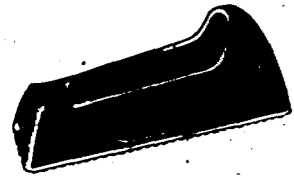

**SURFORM®  
POCKET PLANE**  
Plane for cutting and trimming.  
Flat blade. (87) (21-399SP)

**\$3<sup>99</sup>**



**\$7<sup>99</sup>**

**CROSSCUT  
HAND SAW**

8 point, 26-in. crosscut saw.  
Features specially hardened  
teeth and a square and mitre  
built into handle.  
(88) (15-350SP)



**Rebate**

**12.99**

**-3.00**

**\$9<sup>99</sup>**

**GIFT SET**  
Includes both a 5-in.  
and 10-in. curved jaw  
locking pliers with  
built-in wire cutters  
and quick lock action.  
(92) (215G)

**HOME &  
HOBBY SET**  
Includes both a 7-in.  
curved jaw and a 6-in.  
long nose locking  
pliers with built-in wire  
cutters and quick lock  
action. (93) (213H)  
\* See in-store coupon  
for details.



**\$17<sup>99</sup>**

**THERMOGRIP  
CORDLESS  
GLUE GUN**

Glues anywhere with or  
without a cord. Fast re-  
charge. (89) (TG-C)



**EMHART**



**POP RIVET TOOL**

Sets 1/8-in., 5/32-in.  
and 3/16-in. "POP" rivets. In-  
cludes 2 nosepieces, wrench  
& pouch. (91) (K110)

**\$5<sup>99</sup>**

**THERMOGRIP  
HOUSEHOLD  
GLUE GUN**

Basic hot melt glue gun. Bonds  
in seconds without clamps.  
(90) (203)

**\$6<sup>99</sup>**



**shop-vac®  
16-GALLON  
WET/DRY VAC  
WITH BONUS ACCESSORIES**

**\$79<sup>99</sup>**

High performance  
1.5 H.P. motor for heavy  
duty clean-up jobs, wet  
or dry, indoors or out.  
Comes complete with  
attachments shown. Two year  
home use warranty.  
(88) (808-29-5)

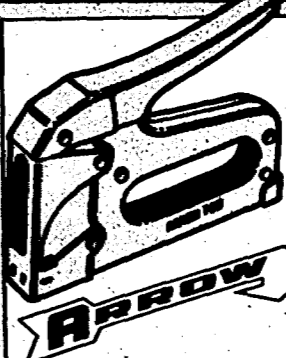

**\$12<sup>99</sup>**

**HEAVY DUTY  
STAPLE  
GUN**

Jam proof all steel con-  
struction. Fires six sizes.  
T-50 staples. Chrome  
finish. (102) (T-50)

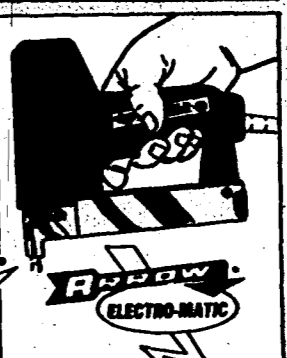

**\$19<sup>99</sup>**

**FLUSH FRONT  
ELECTRIC  
STAPLE GUN**

Fast and easy squeeze  
trigger. Three wire cord.  
Jam-proof mechanism.  
(103) (ETN-50)



**CARPENTER'S  
APRON**

Double-etched, simulated leather  
apron is rivet reinforced. 11 pockets.  
(105) (1527)

**\$17<sup>99</sup>**

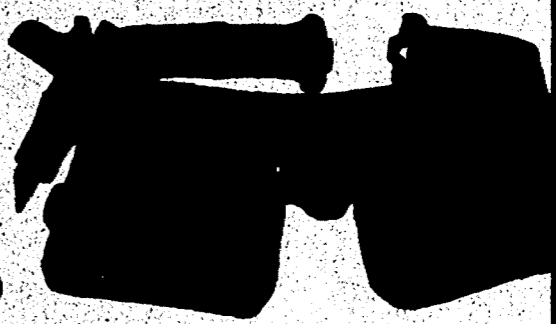

**NEW**



Super

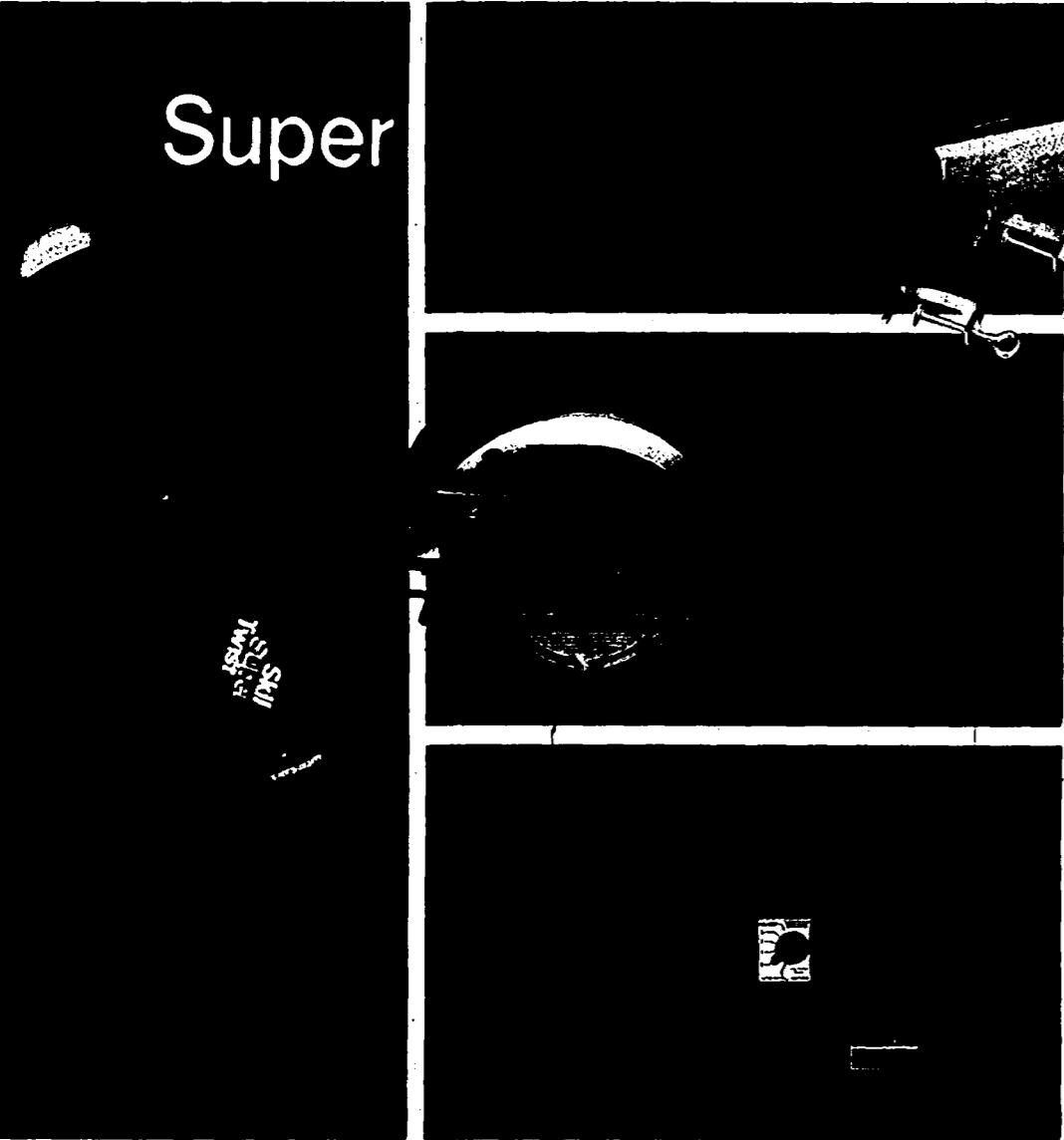

WIN!  
A TRIP FOR TWO

**PRO SKIL**

COME IN FOR ALL  
THE DETAILS

**SKILSAW.**

**8 1/4-IN.  
TABLE SAW**  
2 H.P. motor, 5,500 RPM.  
16-in. x 27-in. die cast aluminum  
table. (68) (3102)

**\$ 189<sup>99</sup>**

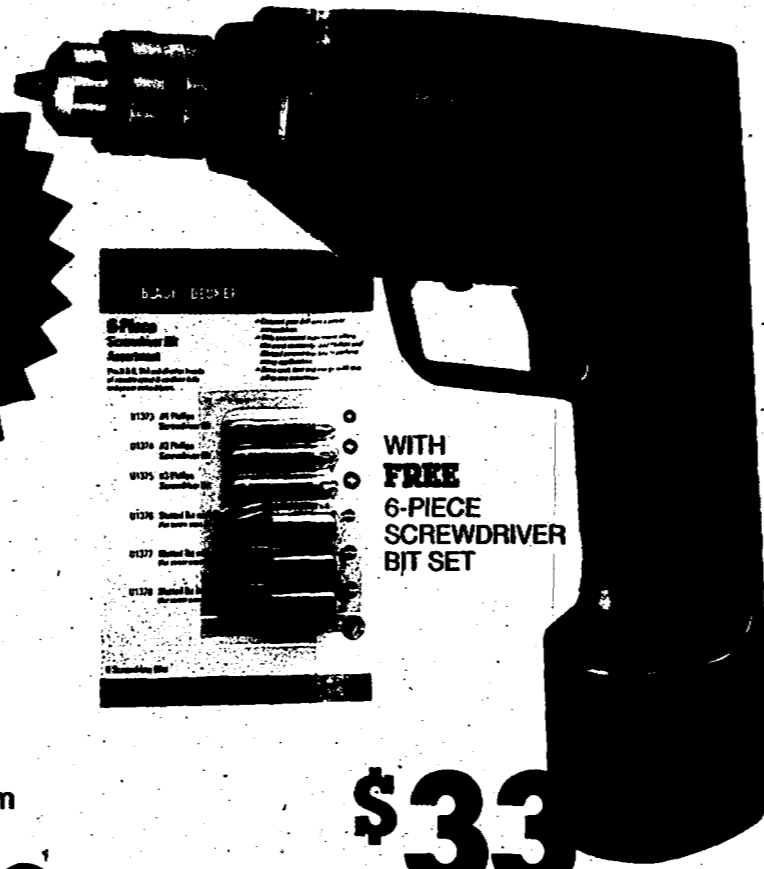

WITH  
**FREE**  
6-PIECE  
SCREWDRIVER  
BIT SET

**\$ 33**

**3/8-IN.  
CORDLESS DRILL**  
2-Speeds. Built-in chuck key  
holder. Recharges in 3 hours.  
2-year home use warranty.  
(76) (9020C)

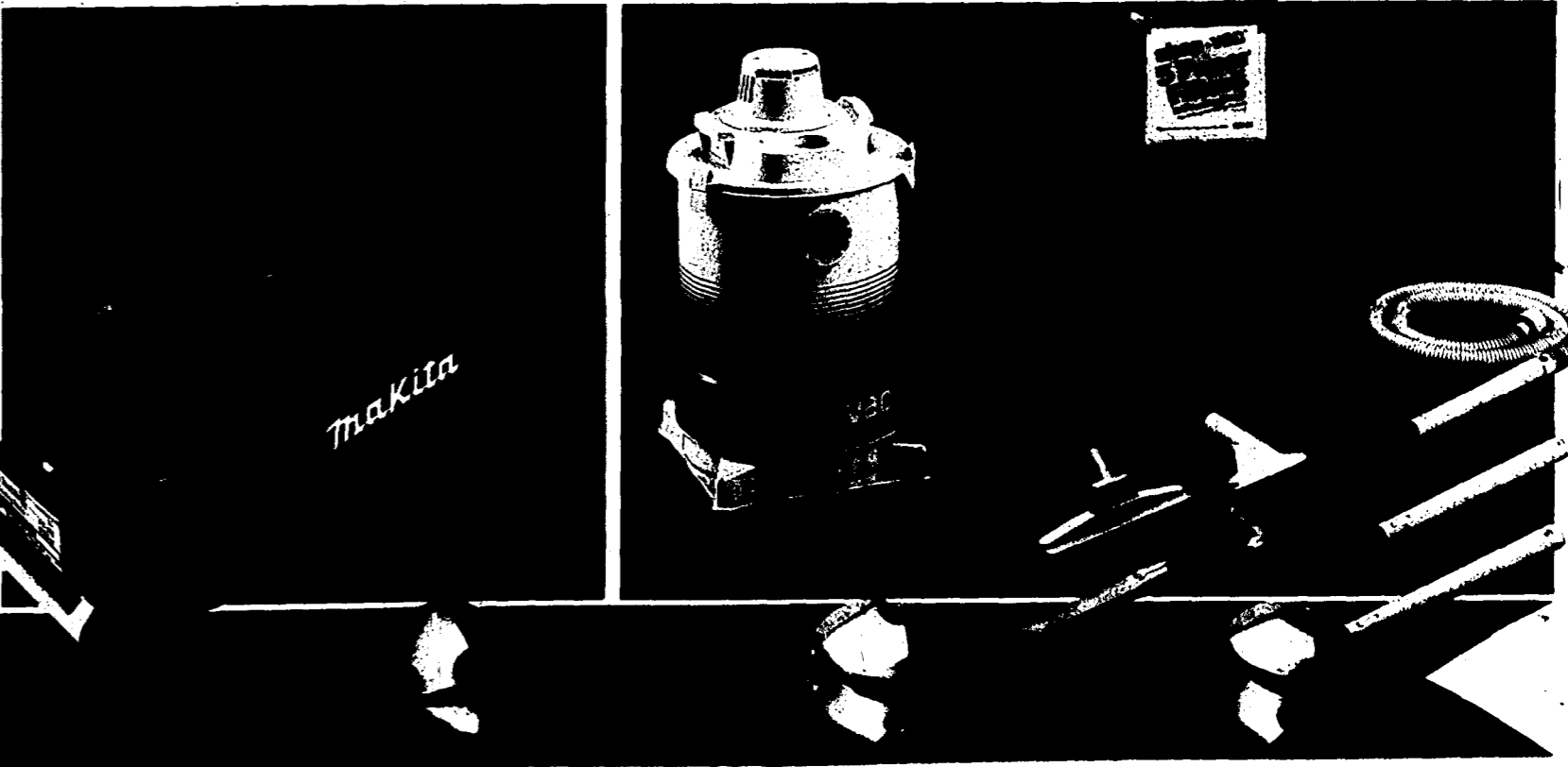
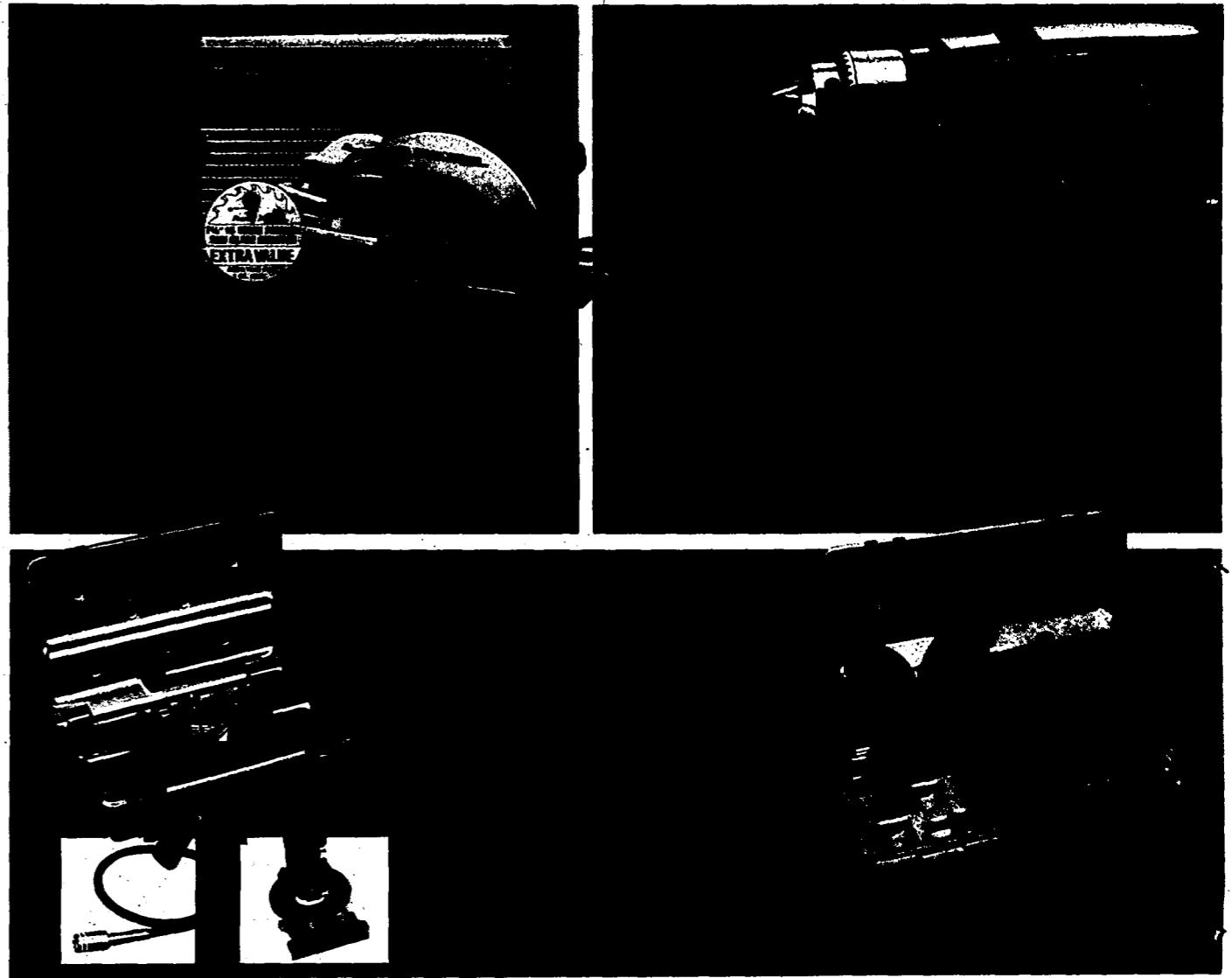

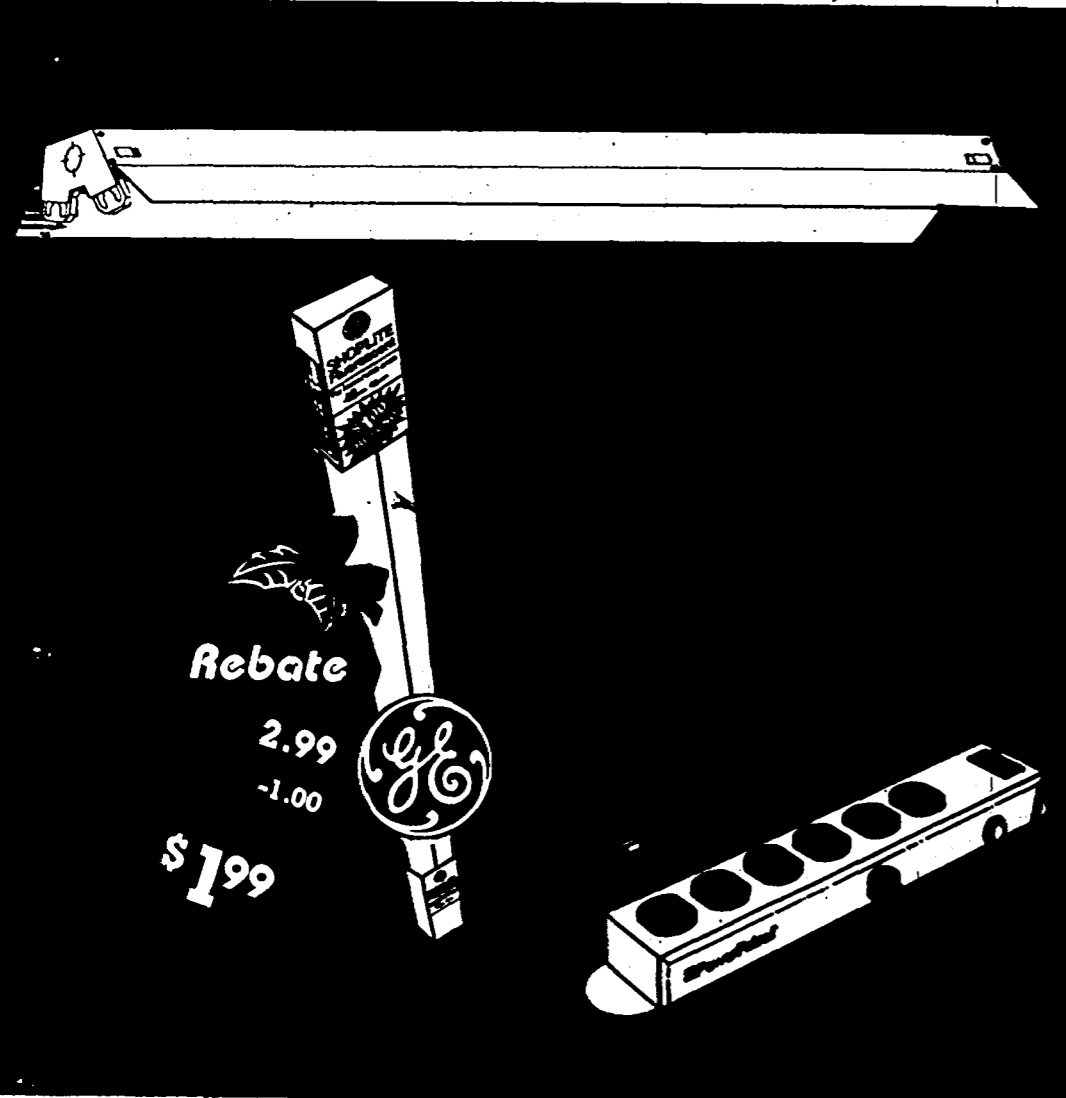

**Rebate**  
2.99  
-1.00  
**\$199**

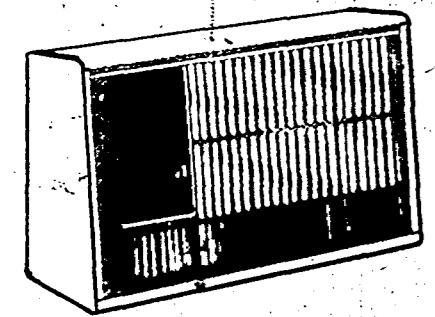

**1250 AND 1500 WATT  
FAN-FORCED  
RADIANT HEATER**  
Two fan-forced heat settings. Automatic thermostat control with positive off. Safety tip-over switch. On/off indicator light. (111) (30H21)  
**\$3699**

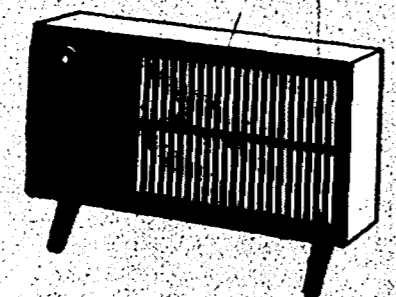

**1320 WATT  
RADIANT  
HEATER**  
Instant heat. Automatic thermostat control with position off. Safety tip-over switch. U.L. listed. (110) (30H25-01)  
**\$2399**



**Delonghi**  
**1500 WATT  
DISC FURNACE**  
WITH THERMOSTATIC  
COMFORT CONTROL  
Enough power to heat large rooms. Instant heat with thermostat settings between 50 and 80 degrees. (108)

**\$12999**

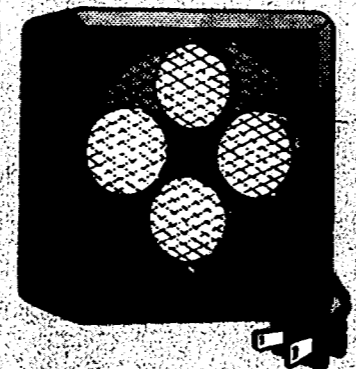

**Arvin**  
**TWO HEAT  
ALERT LIGHT &  
ALARM  
FAN-FORCED  
RADIANT HEATER**  
1250 and 1500 Watt fan-forced heat settings. Features alert light, audible alarm, thermostat control, tip-over switch and on/off indicator light. (112) (30H50)  
Endorsed by the National Fire Safety Council and National Child Safety Council.

**\$4499**

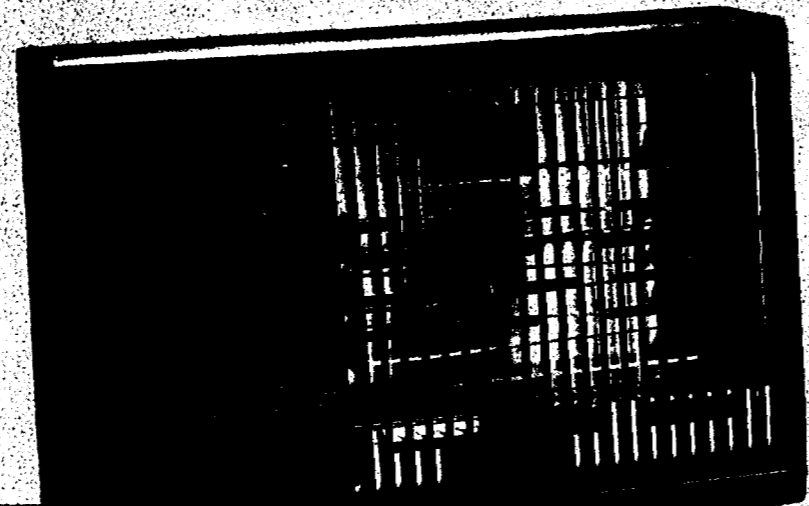

**\$199**

**\$269**

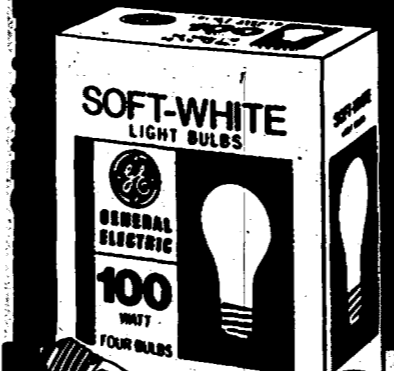

**DURACELL  
ALKALINE BATTERIES  
YOUR CHOICE**

**Rebate** 1.99 -1.00 **99¢**  
**Rebate** 2.69 -1.00 **\$169**

2-"C" (132) (MN1400B2)  
2-"D" (131) (MN1300B2)  
ONE- 9 VOLT (133) (MN1004B)  
4-"AA" (134) (MN134) (MN1500B4)

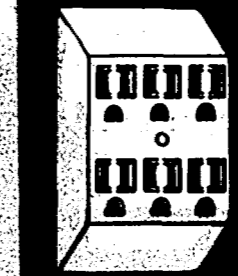

**\$299**

**2 D CELL**  
10-in. long.  
(115) (S2D010/ML-2)

**3 D CELL**  
12 1/2-in. long.  
(116) (S3D010/ML-3)

**4 D CELL**  
14 1/2-in. long.  
(117) (S4D010/ML-4)

**FLASHLIGHTS**  
The exciting new professional quality flashlights that feature an adjustable beam, on/off and blink switch, water tight body and spare bulb in tail cap.  
**YOUR CHOICE**  
**\$1899** EACH

# CHAMBERLAIN

## 1/3 H.P. AUTOMATIC GARAGE DOOR OPENER

Chain drive, steel construction. 4 1/2 minute light delay. Illuminated doorbell button. TOLL-FREE S.O.S. Hotline for purchase or installation information...special order in some stores. (800) 528-9131 (135) (240)

# \$ 139<sup>99</sup>

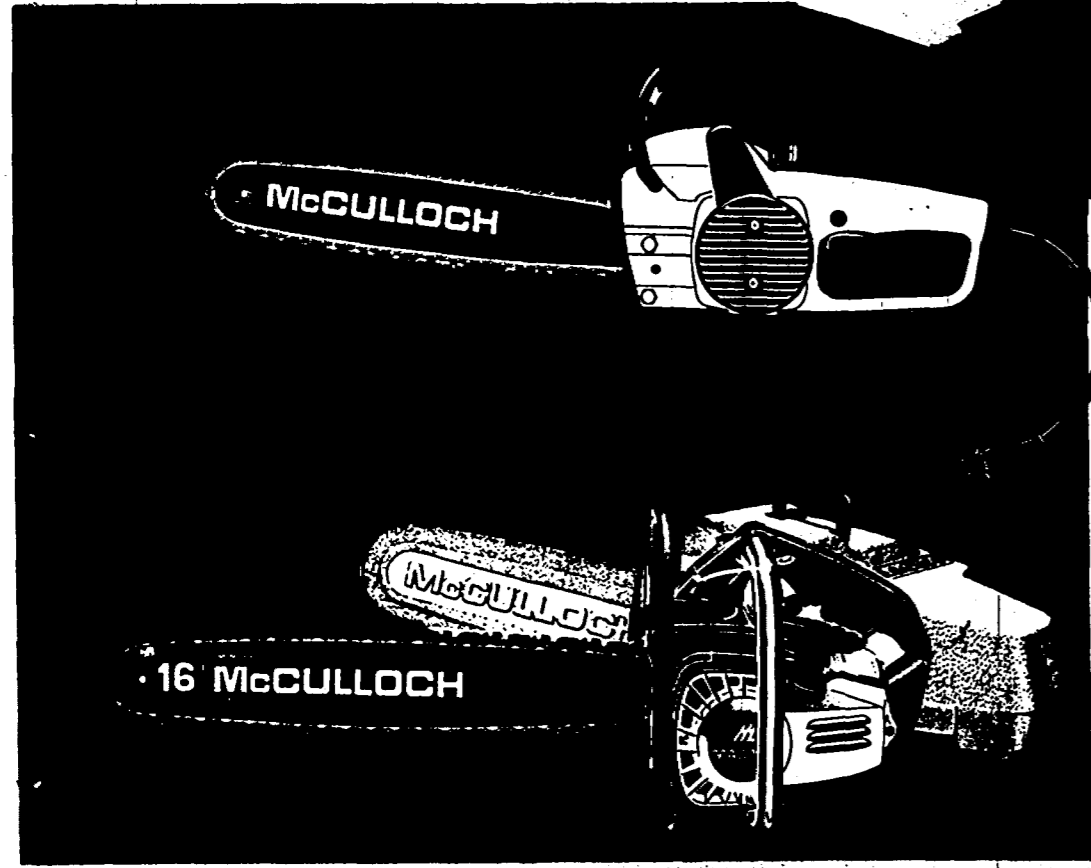
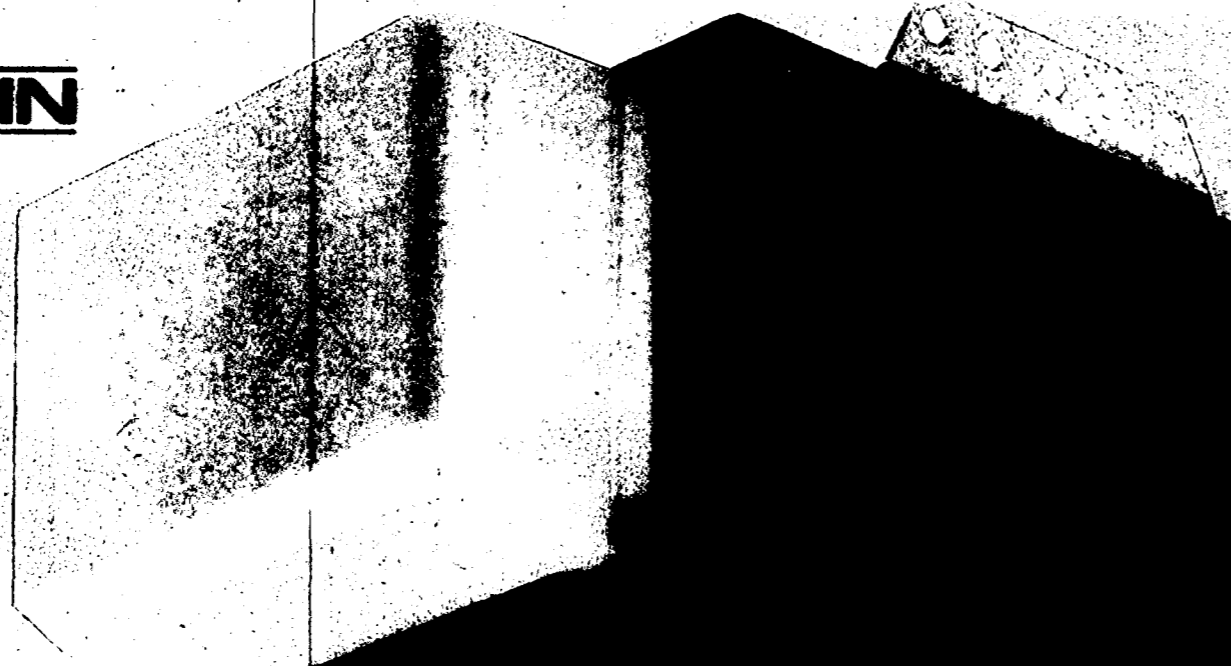

16 McCULLOCH

NEW



### FORCE-9 COMPACT HALON FIRE EXTINGUISHER

Protection for kitchen, electronic or gasoline powered equipment fires. U.L. Rated 2-B.C. Only 10 1/2 inches high. (143) (466028)

# \$ 18<sup>99</sup>

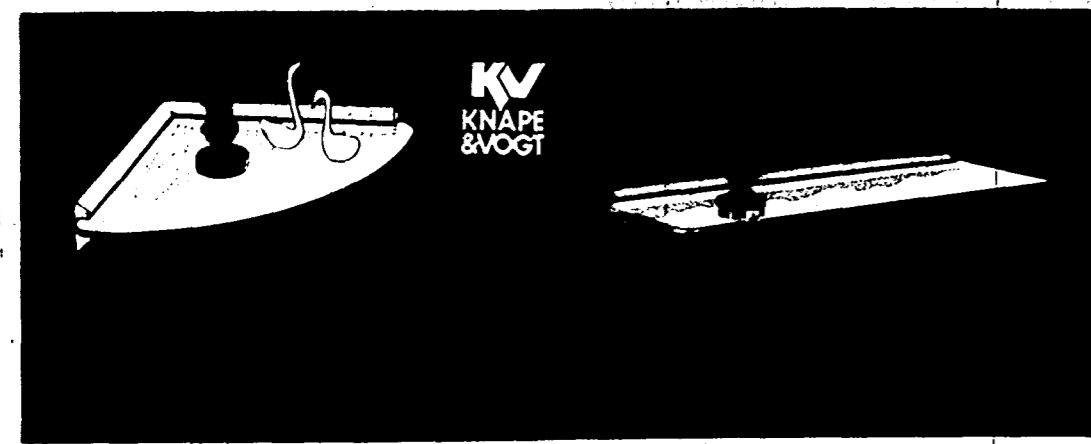

KV  
KNAPE & VOGT



120 VOLT  
**AIR STATION**  
Powerful, fast, convenient 120 volt air source. Inflates tires, air shocks, sporting and recreational items. Includes 3 inflation nozzles, 6 ft. removable hose, 6 ft. power cord, carrying handle. Built in pressure gauge gives continuous readout. Weighs only 4 1/2 lbs. Full 2 year home use warranty. U.L. listed. (145) (9527)

# \$ 59<sup>99</sup>

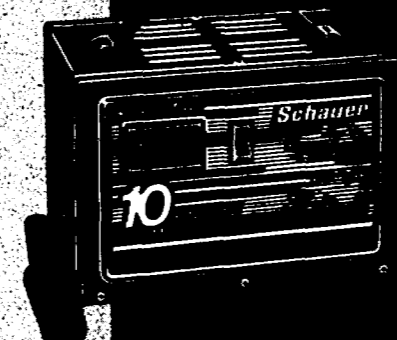

10

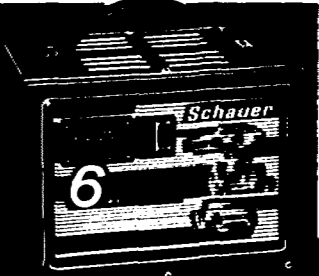

6

Woods<sup>®</sup>  
**\$ 23<sup>99</sup>**



### RETRACTABLE REEL LIGHT

Features 20-ft. 18/3 wire cord, metal cage, on/off switch and grounded plug. (149) (212)

STANLEY

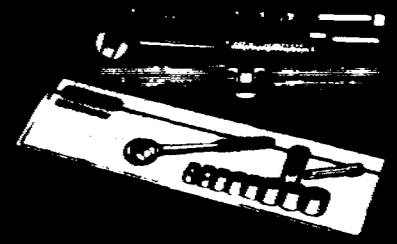

BOOSTER CABLE



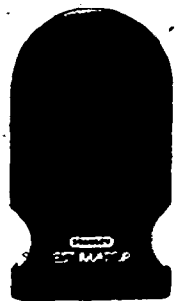

**NEW**

**ULTRASONIC MEASURING TOOL**

Measures distances from 2-feet to 30-feet at the speed of sound with the push of a button. Includes batteries.

**STANLEY**

**ESTIMATOR™ \$39.99**

(152) (389-030)



**11-PIECE SCREWDRIVER SET**

Includes 7 slotted, 3 Phillips and one combination offset. Extra large handles for sure grip. (155) (177758)

**FULLER**

**YOUR CHOICE**

**\$9.99**

**9-PC. COMBINATION WRENCH SET**

Sizes 1/4-in. through 3/4-in. Includes tool pouch. (153) (378265)

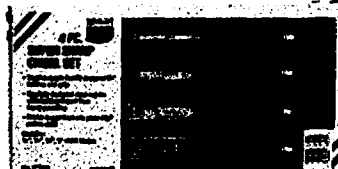

**4-PIECE WOOD CHISEL SET**

Includes 1/4-in., 1/2-in., 3/4-in. and 1-in. with chisel blades. Super sharp. (154) (177725)

**PRO PRO Hardware**

**Christmas Specials**

**CLEAR SEALING TAPE WITH 30-IN. FREE MOUNTING TAPE**

2-in. width. Reusable dispenser with 20 yards of sealing tape. Mounting tape is self-sticking both sides. (161) (OP-160)

**\$2.79**



**STRAPPING TAPE WITH 30-IN. FREE MOUNTING TAPE**

3/4-in. width. Reusable dispenser with 30 yards of strapping tape. Mounting tape has adhesive on both sides. (160) (OP-152)

**\$1.99**

Scotch



**YOUR CHOICE**

**59¢ each**

**MAGIC TAPE WITH 100 FREE INCHES**

Clear tape for wrapping gifts, mending torn paper. Won't yellow. 3/4-in. x 300-in. with an additional 100-in. FREE. (158) (105) 1/2-in. x 450-in. with an additional 100-in. FREE. (159) (104)

**WELLS LAMONT**

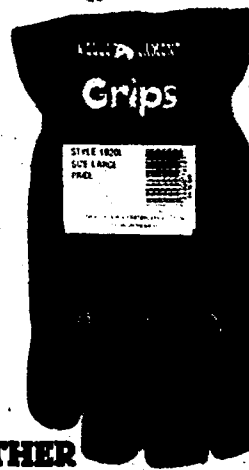

**\$8.99**

UNLINED PAIR

**Grips™ SPLIT LEATHER GLOVES**

Pre-curved design and set-in "butterfly" thumb construction for a comfortable fit.

UNLINED (156)(1010)

**\$8.99 pr.**

LINED (157)(1020)

**\$10.99 pr.**

A MESSAGE TO OUR CUSTOMERS. This circular is a syndicated publication prepared by PRO hardware, Inc. for distribution by over 3500 independently owned and operated PRO Hardware stores and PROMART Home Centers, who set their own retail prices. Due to market changes, product availability and circumstances beyond our control, occasionally an advertised item may not be available. Some items may not be exactly as shown. We reserve the right to correct any printing errors and adjust prices when necessary. The prices shown are suggested prices to our individual member-dealers, they are subject to change without notice and possession of this advertisement does not obligate us or any store to sell at the listed price. Copyright 1988 - CT. Printed in USA.