



The Community Crier

January 27, 1982

The Newspaper with Its Heart in The Plymouth-Canton Community

Vol. 8 No. 51

25¢

Copyright 1982 The Plymouth-Canton Community Crier, Inc.



Icy road blamed for car crash

A VICTIM OF CIRCUMSTANCE. Norma Jean-Stevens, 45, 12510 Pincrest in Plymouth Township, is in critical condition at St. Mary Hospital, according to Plymouth Police, after her car was struck head-on early Monday morning on Sheldon Road. Chief Carl Berry said Stevens was struck when a vehicle driven by

Salvatore Sinagra, of Detroit, swerved from the southbound lane into the northbound lane in an attempt to avoid hitting Carolyn Wieneke, 1656 Nantucket in Plymouth, who had started to pull onto Sheldon and couldn't stop due to ice. No citations were issued. (Crier photo by Robert Cameron)

City and Plymouth Township still talking

Police pact still unresolved

BY KEN VOYLES

This Tuesday Plymouth Police Department patrolmen and officers could patrol the streets of Plymouth Township, as they have been doing for nearly one year, but without a contract to do so.

The township contracted with the City of Plymouth for protection last February when it looked like Wayne County Sheriff's patrols would cease due to a lawsuit.

The Plymouth patrols then began. And a year later the 20-man force, including 14 patrolman and six officers, is still on the job. City Manager Henry Graper and Township Supervisor Maurice Breen will discuss renewal of the contract in several closed sessions this weekend.

When asked on Monday how long the negotiations might take, Graper said a settlement might be reached in only one meeting. Breen declined to comment, reserving his remarks for after the bargaining.

Chief among the issues to be discussed are possible cost increases as well as service increases or decreases.

Police Chief Carl Berry said he will not pull his units off the streets.

"This contract has been totally unique for the state and the community. We have two different forms of government

working together on a joint project," Berry said.

The original agreement as worked out by Graper and Breen called for the township to pay \$269,565 for 12 months, or \$23,209 per month. Costs go higher with a series of add-on charges, such as the purchase of the police antenna located in the township, charges that are estimated at \$62,356 by the city.

Those costs were assessed to give the township a fair share of the department's time, 37 per cent, according to city officials. A look at the final monthly department report for December reveals that in many areas the service time was closer to 50-50.

For example, in administrative functions 1,711 formal reports were filed for the city and 1,797 for the township. In traffic, there were 243 property accidents in the city and 250 in the township. The city had 74 injury accidents and the township 128.

Crimes against persons were virtually even for the city and township (example: 13 felonies in each, or three unarmed robberies in each).

The city had 364 larcenies over the year, while the township had 565. There were 216 acts of vandalism in the city and 188 in the township.

Information from Investigation and

Services (including the Detective Bureau) reveal a lean toward the city. For example, as of November the department had spent 42 hours overtime in city cases and 24 more in the township.

An interesting footnote to the report revealed 71 instances of "disorderly behavior" in the city and 76 in the township. That number exceeds listings like burglary against non-residence, a 117 total.

The figures are slightly deceiving, however, because the township has a population and square mileage over twice that of the city, says Berry.

Many of the original contract's terms are revealed under section 1.2, scope of services. In 10 qualifiers it spells out

Cont. on pg. 31

P-C students slip a little on state tests

BY DAN BODENE

Fewer Plymouth-Canton students who were tested on Michigan Educational Assessment Program (MEAP) reading and math objectives attained scores as high as last year's.

The Plymouth-Canton district nonetheless was ranked higher this year among other Wayne, Oakland and Macomb county districts, says David Rodwell, administrative assistant for research and data processing.

Rodwell said the results of the annual test showed Plymouth-Canton Community Schools were ranked in the second-highest category among the tri-county area MEAP scores.

Compared to the 1980 scores, the district dropped in the number of tested 4th, 7th and 10th graders who scored 75 per cent or higher in the total reading and math objectives.

Since 1976 trends in top reading percentages have increased for all three grades. Highest percentages in math objectives dropped for 4th graders and increased in 7th graders since 1976 and declined in 10th graders since 1978 (in 1980, the tests were revised).

Rodwell explained that the state test was administered differently than are Plymouth-Canton district instructional methods. One problem, he said, was that some questions were pertinent to concepts not yet introduced to district students. Another was unfamiliar question formats.

Fewer students were tested this year than in 1980, Rodwell added.

He said a nine-year study is being conducted in the district using an evaluation of common objectives, to help track progress through several grade levels. It could also determine if some students, Rodwell said for example, were learning by rote at 7th grade but picked up concepts shortly thereafter.

The 1981 MEAP scores for Plymouth-Canton will be used to help improve program specifics at several levels, Rodwell said.



pgs. 15-30

Inside today's Crier!

The Contemporary Bride

For expressway identification

Plymouth C of C pushes billboards

If the Plymouth Chamber of Commerce gets its way there will soon be a sign up along I-275 south of the M-14 intersection, extolling the qualities of the Plymouth Community.

Scott Lorenz, heading the Chamber committee to get the sign approved, sent a letter to the Plymouth Township Planning Commission which was read at last Wednesday's regular meeting.

The commission discussed the letter at the end of Wednesday's meeting, and discussed another to be returned to Lorenz and the Chamber.

There was some confusion among the commission as to whether the sign would be a billboard advertisement or an entrance sign, similar to the three entrance signs already posted on the edge of the two communities.

Commissioner Smith Horton noted a provision in the township's ordinance (47) that allows for entrance signs that are no higher than eight feet and do not exceed 50 square feet.

Commission Chairman Richard Gornick said, "We resist billboard advertisements, but are willing to work with the Chamber to let them know what is allowable."

Commissioner Lee Fidge said she would like to know the language of the

sign to make sure the township is not inadvertently left out of the wording.

Township Planner James Anulewicz said, "The Chamber needs to express specifically what they're after."

According to Scott Lorenz the plan is to come up with a billboard to promote "the Plymouth Community," its shops, culture and historic value.

Lorenz said if approval is granted by the township, the state will also have to approve the sign along the state freeway.

"We think an exception to the township's ordinance could be made to benefit both the city and township," Lorenz said.

Lorenz added once approval from the township and the state is obtained his committee will look for a suitable location for the sign and approach the owners of the property. He estimates cost at \$15,000 to \$20,000.

P-C School Council to offer public forum

Plymouth-Canton School District parents will have a chance to find out about the school system at a series of public forum meetings being put together by the Plymouth-Canton Community

School Council.

The first session which will take up the district's instructional skills program, is set for Feb. 9 at the Board of Education office. The meeting will start at 7:30 p.m.

The Plymouth-Canton Community Schools Council is composed of representatives from each building in the system as an informational group.

At the Feb. 9 meeting Dr. Mike Homes, assistant superintendent for instruction, will be on hand with a presentation of the instructional skills program and will be available to field questions.

A second meeting is being planned to provide information on the school budget process and the school financial picture.

The meeting is open to the public. It will provide an opportunity for parents to become more aware of how the Plymouth-Canton Schools work, what the problem areas are and how these problems are being addressed.

Coffee will be available at the meeting.

Governor Milliken names Bev McAninch to state energy group

Beverly McAninch, 539, S. Sheldon Road, Plymouth, will serve on the Michigan Energy Awareness Advisory Committee.

She was one of 15 appointments announced by Gov. William Milliken to the 56-member committee.

She is currently serving as president of the Michigan League of Women Voters. She succeeds Katherine Cushman of Dearborn as a member of the committee.

Ford Road widening will start in spring

Drivers in the Plymouth-Canton area who use Ford Road and the northbound exit off Ford Road to I-275 will have a light to help ease the traffic problem at the intersection.

Canton Township Treasurer Maria Falkiewicz said Monday morning that the township board got a positive response

from the Michigan Department of Transportation to a request from the township for a light.

According to the letter received from the state a traffic light will be installed as part of the Ford Road widening project due to be under construction in the spring.

PLAN FOR TOTAL COMFORT SAVINGS

PLAN "A"

Amana HTM™ - THE AMAZING BREAKTHROUGH FURNACE THAT CUTS FUEL BILLS

UP TO **40%**

HTM Plus™ Heat 'n Hot Water System and add-on Amana High Efficiency Air Conditioning

A total home comfort system that gives efficient cooling and heating, plus all the hot water you need!

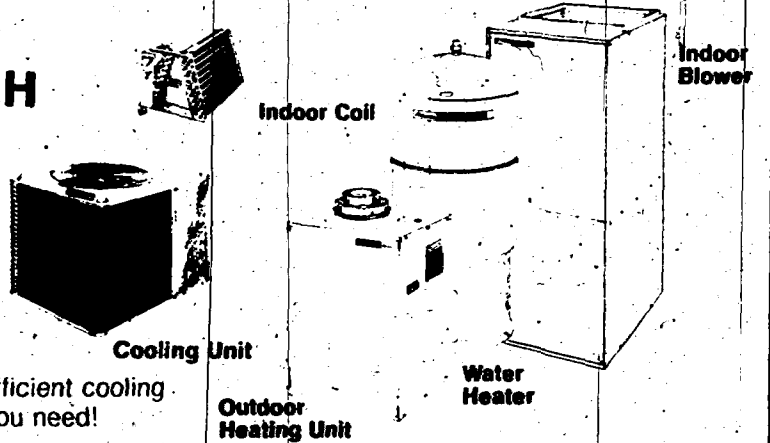

PLAN "B"

Amana Air Command Furnace and Central Air Conditioning



PLAN "C"

Amana Electric/Gas Cooling-Heating Unit

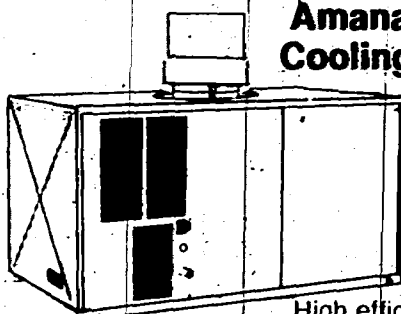

High efficiency cooling and heating from a single unit that sits outdoors!

Amana Radarange

REWARD

GET THIS AMANA RADARANGE **\$89** WHEN YOU BUY PLAN A FOR ONLY **\$89** BUY PLAN A or PLAN B or PLAN C



- Model RR-7B
- 700 watts of power
- Stainless Steel interior
- Exclusive Rotawave™ cooking system
- Ten Cookmatic™ power levels

FOR MORE INFORMATION, CALL

455-6500

COLONIAL

HEATING AND COOLING

• TOTAL COMFORT SPECIALISTS •

464 N. Main, Plymouth

HEAT PUMPS AVAILABLE





Library gets new look

REMODELING at the Dunning-Hough Library in Plymouth includes not only the installation of new shelving, but new carpet as well. The library is closed this week while volunteers reshelve thousands of

volumes and remodeling is completed. The book drop at the rear of the building will remain open, however. The library will again open for business on Monday, Feb. 1 at 10 a.m. (Crier photo by Robert Cameron)

For block grant ideas

City commission sets hearing

A public hearing will be held at 7:30 p.m. Feb. 16 in Plymouth City Hall to discuss possible project ideas for the next three-year period of the federally

sponsored Community Block Grant Program.

City Commissioners set the hearing at last week's regular meeting so that public

input could be garnered for the program.

Block Grant money is received yearly for community projects that fit one of three criteria -- must have principal benefit to low or moderate income residents; prevent or eliminate slums or blight; or must meet an urgent community need.

Resident input gained before the meeting will be presented and residents will have a chance to add further input at the meeting. A list of priorities will then be tabulated.

Project ideas can still be forwarded to the Plymouth Advisory Council for Block Grants, care of John Behman, 201 S. Main, Plymouth, 48170. Or call Behman at 453-1234 at ext. 12.

The City Commission will make a final decision on which projects will be submitted at the March 15 meeting and send them on to the county level by the April 1 cutoff.

Diane Dart resigns as Chamber executive

Diane Dart has resigned as executive director of the Plymouth Community Chamber of Commerce, and a replacement is now being sought.

Dart, who began her job with the Chamber last January after a stint with Burroughs Corporation, will attend Madonna College to finish work on a business degree. Her resignation was not anticipated, says Chamber secretary Sharon Holroyde, because she unexpectedly received a scholarship to the college.

Dart lives in Canton with sons David, 13, and Steven, 10.

The Chamber is searching for new candidates for the executive director position. Experience in Chamber management and a college degree is preferred, in addition to experience in selling, fundraising, publicity and office management.

Applications available from the Chamber and resumes must be turned in by Feb. 10 to the Chamber office, 188 N. Main, Plymouth.

2 school board seats to be filled in June

Two members of the Plymouth-Canton Board of Education are coming to the end of their regular terms -- and at least one won't be seeking reelection in June.

Board President Carol Davis has decided to call it quits after her term expires in June. "I looked at it, five years on the board, and it's been a long time," she explains. "I want to spend more time with my family."

Davis, who was elected to the board in 1976, was most recently voted its president in June, 1981.

The other impending expiration is the board term of Elaine Kirchgatter, who says she has not decided yet whether to seek reelection.

Petitions for the two board seats will be available in April.

Canton planners decide to relax stiff sign ordinance

BY DICK BROWN

It won't be the most popular decision to come out of the Canton Township Planning Commission, but larger signs and easing of the township's tough sign ordinance is on the way if the Canton Township Trustees agree with the planning commission recommendations.

The sign ordinance changes would permit tower signs up to 150 feet high at freeway intersections with the sign itself sized up to 325 square feet. Currently the sign ordinance does not allow any tower signs.

Billboards could be erected that are 14x48 feet in size. They could be placed on commercial or industrial property adjacent to I-275 freeway and within 100 feet of the interstate right of way. There would have to be at least 1,500 feet between billboards. The present ordinance forbids this type of signing.

A change was also recommended which would increase the allowable size of advertising signs to 80 square feet on main streets such as Ford, Cherry Hill and Canton Center Road and up to 100 square feet on Michigan Avenue.

The ordinance amendments approved by the planners would also allow portable signs, one of the most controversial recommendations.

There are other minor changes being recommended.

Changes in the sign ordinance have been pushed by individual businesses and by the Canton Chamber of Commerce. Change proponents cite the fact that freeway drivers pass the I-275 exits at Ford Road and Michigan Avenue before they become aware of motels, restaurants and other businesses. Proponents of easing the sign ordinance maintain that Canton businesses are moving and folding and that relaxing the stiff sign code could mean the difference between staying and leaving.

Those signs won't be going up higher and getting bigger right away.

First the ordinance changes will have to be discussed and approved by the Wayne County Planning Commission. Indications are that the changes will be placed before the county planning group at its Feb. 3 meeting. That would bring it before the Canton Township Board for final approval or rejection at the Feb. 9 board meeting.

All local violation bureaus give way to district court

Effective Feb. 1, there will no longer be violation bureaus in the administrative offices of the Cities of Plymouth and Northville and Plymouth Township and Northville Township.

These four local governmental units, along with Canton Township, comprise the 35th District Court.

All tickets are to be paid in person or by mail at the 35th District Court office, 660 Plymouth Road, Plymouth 48170, according to George Wieland, district court administrator.

Business hours at the court are from 8:30 a.m. to 4:30 p.m. Monday through Friday.

When the court moved into its new quarters, all the local units reserved the right to operate their own traffic bureau, except Canton.

For 'State of the Township' message

Canton supervisor calls public forum

BY DICK BROWN

Canton Township Supervisor Jim Poole has called a special town meeting for Thursday, Feb. 4, at the Township Administration Building to present a "State of the Township" message to Canton residents. The meeting will start at 7 p.m.

Poole, in calling the meeting, said, "This is an educational meeting. A majority of the people don't understand their tax bill, don't understand under what authority taxes are levied and what services the township provides and what services residents think the township should provide."

Poole said he intends to speak to the financial condition of the township and touch on some projects such as the Haggerty Road paving. He also intends to touch on some of the areas of concern as reflected on calls from residents in such subject areas as road maintenance, sidewalk snow removal, privacy fences and ordinance enforcement.

"This is another in a series of public information meetings I have instituted since I took office in an effort to keep the public informed," Poole said.

"It won't be a one-way conversation," Poole promised, "Throughout the evening there will be question and answer periods to help people understand their taxes, the functions of various governments and what services can be expected or not expected," he said.

To answer those questions township department heads will be on hand, along with representatives from the Wayne County Road Commission. An invitation to attend the meeting and answer questions has also been extended to 27th



"A STEP TOWARD UNDERSTANDING" is what Canton Township Supervisor Jim Poole labeled his State of the Township meeting set for the Canton Administration Building for Feb. 3 at 7 p.m. The public forum will air the township financial picture, hit on road maintenance and construction and provide an opportunity for township residents to ask questions and learn about what they get in the way of township services and where the money comes from and goes. (Crier photo by Dick Brown)

District County Commissioner William Joyner, 13th District Senator William Faust and 37th District State Representative Tom Brown.

"This is a chance for Canton residents to find out about what they can and should expect from their township government," Poole said. "I want the

people to know now what to expect and not be shocked later in this economic climate where taxes are going up as services decline."

Poole went on to say, "Last November only 17 per cent of the Canton voters turned out at the polls to have a voice in changing the structure of Wayne County government and Canton's own farmland preservation proposal. That's not a very representative turnout. I hope we fill the hall with people interested in Canton government."

Las Vegas Night set at Cultural Center to benefit Symphony

Plymouth Cultural Center will take on the look of a Las Vegas gambling casino on Feb. 6 when the Crescendos group of the Plymouth Symphony League "Swings into Spring with a Las Vegas Fling."

The Crescendos will have roulette wheels, Black Jack tables and crap games. Participants in the fun evening will each receive \$100,000 worth of chips at the door to use to test their luck. The games will run from 8 p.m. to 11 p.m. At 11 p.m. lots of prizes will be put on the auction block so the lucky winners may cash in their chips.

Tickets are priced at \$7.50 and will include the chips, three hours of Las Vegas fun and all the popcorn a person can eat.

Tickets are available from any Crescendo member and at Armbruster's Bootery and The Health Food Shoppe. A limited number of tickets priced at \$9 per person will be available at the door.

There will also be a cash bar and chips, pretzels and pop.

Fidge accepts Rouge Watershed post

Plymouth Township Trustee and Planning Commission member, Lee Fidge, was named to the paying position of executive director for the Rouge River Watershed Council (RRWC).

Fidge was chairperson of the organization, which seeks to offer input into the uses of the Rouge for wastewater management, but when Marci Colling turned in her resignation Fidge offered

the RRWC a short term contract.

"It was the shortest term for chairperson the RRWC has ever had," Fidge said. "When Marci put in her resignation we had to come up with someone to fill the position within two weeks."

Fidge called an emergency meeting last Monday and proposed that she take the job on a 30-day contract. Members of the board, however, were so akin to the idea

of Fidge as executive director that they suggested a six month contract instead.

According to Fidge it is her first paying job in the organization.

"The members of the RRWC teased me about wanting to drop the chair position - they know how much I hate to chair anything," Fidge said. "Other than that they were all for the idea."

25th reunion planned

Plans are underway for the 25th Class Reunion of members of the Plymouth High School Class of 1957.

The reunion is scheduled for July 3.

Class members desiring more information can call 453-5576 or 459-2622.

Finlan Insurance Announces

Bev Hoisington
Don't You Love It!

- 15% Preferred Driver Discount
- 10% Senior Citizen Discount (Over 55)
- 10% Non-Smoker Discount
- 3-5% Discount on Smoke and or Burglar Alarm System

COMPLIMENTS
Citizen
INSURANCE COMPANY OF AMERICA

Call Bev • 453-8000
C.L. Finlan, Fisher/Wingard/Fortney

Terry's Bakery
880 W. Ann Arbor Tr.
Plymouth
453-2161

Donut Special
Buy 1 Dozen at Regular Price

Get 1/2 Dozen FREE

with this coupon

Offer expires 2/3/82

HARGRAVE & SONS
Heating and Air Conditioning

25% off

Vent damper installation through Feb. 3

207 W. Ann Arbor Trail
459-8310

The Community Crier

USPS-304-150
Published each Weds.
at 1226 S. Main St.
Plymouth, Mich. 48170
Carrier delivered: \$10 per year
Mail delivered \$16 per year.
(Mailed at Controlled Circulation rates, Plymouth, Mich. 48170)
Call 453-6900 for delivery.

The Crier's advertisers strive to honestly present commercial messages to our readers. If, for any reason, you find problems with a Crier ad, please call our office at 453-6900.

Crier advertising is published in accordance with those policies spelled out on the current rate card, which is available during business hours from our office at 1226 S. Main St., Plymouth. An advertiser's final acceptance by the publisher is conditioned only upon its publication.

Postmaster, send change of address notice to 1226 S. Main St., Plymouth, MI 48170.

Coming Up Around The Town

February 1 Monday
Optimist Club, Mayflower Hotel 7 p.m.
Canton Kiwanis, 6:30 p.m. Cyprus Gardens.
Canton Rotary, Roman Forum noon.
Recovery Inc. 8 p.m. Central School.
Pilgrim Shrine #55 Grange Hall, 7:30 p.m.

February 2 Tuesday
Canton Jaycettes, Canton Rec. Center 8 p.m.
Oddfellows, 8 p.m. Oddfellows Hall.
Toastmasters International The Oral Majority, 5:30 p.m. Denny's Restaurant Ann Arbor Rd. Info 455-1635.
Creditors, Elks Club 12:30-3 p.m.
Ply. Community Chorus, East Middle School 8-10 p.m. no auditions, Info 455-1248.
Ply. Kiwanis 6:30 p.m. Mayflower Hotel.

February 3 Wednesday
Canton Senior Mens Club, Rec Center 3-5 p.m.
P.C.A.C. Art Rental Gallery, 10-8:30 p.m.
Dunning Hough Library.
Fall Festival Board, 8 p.m. City Hall.
Canton Chamber of Commerce, Roman Forum noon.
Canton Newcomers, Pioneer Middle School 7:00 p.m.
Three Cities Art Club, 7:30 p.m. Salem High Room 1212.
Senior Citizens Happy Hour, 12-4 p.m. Cultural Center.

February 4 Thursday
Plymouth-Canton Civitan Business Meeting Office Gene Kafila 7:30 p.m.
Colonial Kiwanis, 12:05 Mayflower.
Senior Citizens Club, 1-4 p.m. Tonquish Creek.
Lions Club 6:30 p.m. Mayflower Hotel.
Senior Citizens Party Bridge, 1-5 p.m. Ply. Cultural Center.

February 5 Friday
The Woman's Club of Plymouth - First United Presbyterian Church, 12:30 p.m. Chairman Marguerita Ross, Program Mr. Ernest Dumochelle.
Ply. Rotary, 12:05 Meetinghouse.
West Suburban Stamp Club, Ply. Cultural Center 7:30 p.m.

February 6 Saturday
Plymouth Symphony Society "Swing into Spring at our Las Vegas Fling" Plymouth Cultural Center.

February 7 Sunday
Plymouth Symphony presents "All Orchestral Gala" 4 p.m. Ply. Salem High School.
American Legion Post #391 Memorial Home 8 p.m.
Parents w/o Partners, 8 p.m. Coffee & Conversation 8 p.m. Info 455-4188.

February 8 Monday
Knights of Columbus, 7 p.m. KFC Hall.
Canton Rotary, Roman Forum noon.
Toastmasters International, 6:30 Mayflower Hotel.
Rock & Mineral Society, Ply. Cultural Center, 7:30 p.m.
Canton Kiwanis, 6:30 p.m. Cyprus Gardens.
Canton Business & Professional Womens Club, Cyprus Gardens 6:30 p.m. Program Judging of "Young Careerist."
Recovery Inc. 8 p.m. Central School.

February 9 Tuesday
Ply. Community Counsel on Aging, 2 p.m. Cultural Center.
Ply. Kiwanis, 6:30 p.m. Mayflower Hotel.
Canton Jaycees, Canton Rec Center 7:30 p.m.
Creditors, Elks Club 12:30-3 p.m.
Toastmasters International The Oral Majority, 5:30 p.m. Denny's Restaurant Ann Arbor Rd. Info 455-1635.
Plymouth Community Chorus, East Middle School 8-10 p.m. no auditions, Info 455-1248.
Plymouth Chamber Caucus Luncheon 11:30 p.m. Hillside Inn.
Ply. Jaycettes, 8 p.m. Hostess Gayle Nelson.

February 10 Wednesday
P.C.A.C. Art Rental Gallery, 10-8:30 p.m.
Dunning Hough Library.
League of Women Voters, 11:30-2:30
Intergovernmental Relations within Michigan - Northville City Hall.
Senior Citizen Happy Hour, 12-4 p.m. Ply. Cultural Center.

February 11 Thursday
Colonial Kiwanis, 12:05 Mayflower.
Community Fund, 8 a.m. Colony Office Plaza.
Canton Historical Society, 7:30 p.m. Historical Museum.
Soroptimist Club, Business Meeting, 6 p.m.
Nicky's Lounge 5 Mile.
Plymouth Jaycees, 7:30 Cultural Center.
Plymouth Historical Society, 7:30 p.m. Museum.
Senior Citizens Club, 1-4 p.m. Tonquish Creek.
Senior Citizens Party Bridge, 1-5 p.m. Ply. Cultural Center.

February 12 Friday
Bank will be open from 9:30 a.m. to 4:30 p.m. with no extended hours.
Rebekah, 8 p.m. Oddfellows Hall.
Ply. Rotary, 12:05 Meetinghouse.
Parents w/o Partners, UAW Hall, Eckles Rd. 8:30 p.m.

February 13 Saturday
Centennial CB Organization, 1-4 p.m. Oddfellows Hall.

February 14 Sunday
Parents w/o Partners, Coffee & Conversation 8 p.m. Info 455-4188.

February 15 Monday
Ply. Business and Professional Women's Club Hillside Inn 6:30 p.m.
Optimist Club, 7 p.m. Mayflower Hotel.
Canton Kiwanis, 6:30 p.m. Cyprus Gardens.
Canton Rotary, Roman Forum noon.
Recovery Inc. 8 p.m. Central School.

February 16 Tuesday
Oddfellows, 8 p.m. Oddfellows Hall.
Creditors, Elks Club, 12:30-3 p.m.
Canton Cable TV advisory comm. 7:30 p.m. Library.
Toastmasters International The Oral Majority, 5:30 p.m. Denny's Restaurant on Ann Arbor Rd., Info 455-1635.
Ply. Community Chorus, 8-10 p.m. East Middle School, no auditions Info, 455-1248.
Ply. Kiwanis 6:30 p.m. Mayflower Hotel.
Ply. Theater Guild, 8 p.m. Central Middle School.

February 17 Wednesday
Kiwanis Clubs of Plymouth present Richard Kern "Smoky Mountain Magic" 8 p.m. Salem High School.
P.C.A.C. Art Rental Gallery, 10-8:30 p.m.
Dunning Hough Library.
Canton Senior Mens Club, Rec. Center 3-5 p.m.
Canton Public Library Board, 7:30 p.m. Library.
MACLD, 7:30 p.m. Pioneer Middle School.
Senior Citizens Happy Hour 12-4 Cultural Center.

February 18 Thursday
Civitan, Plymouth Canton Hillside Inn 7 p.m.
Optimist Club, Mayflower Hotel 7 p.m.
Colonial Kiwanis, 12:05 Mayflower.
Growth Works Board, 7:30 p.m. Growth Works.
German-American Club of Plymouth, 8 p.m. Oddfellows Hall.
Plymouth Chamber Board 8 a.m. Hillside Inn.
Senior Citizens Club, 1-4 p.m. Tonquish Creek.
Lions Club, 6:30 Mayflower Hotel.
Senior Citizens Party Bridge 1-5 p.m. Ply. Cultural Center.

February 19 Friday
West Suburban Stamp Club, Ply. Cultural Center 7:30 p.m.
Ply. Rotary 12:05 Meetinghouse.

February 21 Sunday
Parents w/o Partners, Coffee & Conversation 8 p.m. Info 455-4188.

February 22 Monday
Recovery Inc. 8 p.m. Central School.
Canton Rotary, Roman Forum noon.
Canton Kiwanis, 6:30 p.m. Cyprus Gardens.
Toastmasters International, 6:30 Mayflower Hotel.

February 23 Tuesday
Ply. Community Chorus, East Middle School 8-10 p.m. no auditions Info 455-1248.
Creditors, Elks Club 12:30-3 p.m.
Ply. Kiwanis, 6:30 p.m. Mayflower Hotel.
Toastmasters International The Oral Majority, 5:30 p.m. Denny's Restaurant, Ann Arbor Rd. Info 455-1635.

February 24 Wednesday
Family Service Advisory Comm. 8 a.m. Colony Plaza Office.
P.C.A.C. Art Rental Gallery, 10-8:30 p.m. Dunning Hough Library.
American Association of Retired People, Cultural Center - Bag Lunch-Sing Along 12-2:30 p.m.
Senior Citizen Happy Hour, 12-4 p.m. Ply. Cultural Center.

February 25 Thursday
Colonial Kiwanis, 12:05 Mayflower.
Soroptimist Club, Program Meeting, Speaker from "First Step" - 6 p.m. Nicky's Lounge Five Mile.
Plymouth Jaycees, 7:30 p.m. Cultural Center.
Senior Citizens Club, 1-4 p.m. Tonquish Creek.
Senior Citizens Party Bridge 1-5 p.m. Ply. Cultural Center.

February 26 Friday
Rebekah 8 p.m. Oddfellows Hall.
Ply. Rotary 12:05 Meetinghouse.
Parents w/o Partners UAW Hall, Eckles Rd 8:30 p.m.
Civitan Mid Year Convention Jackson.

February 27 Saturday
Centennial CB Organization 1-4 p.m. Oddfellows Hall.
Civitan Mid Year Convention Jackson.

February 28 Sunday
Parents w/o Partners, Coffee & Conversation 8 p.m. Info 455-4188.
Civitan Mid Year Convention Jackson



Member F.D.I.C.

The Community Calendar is a public service of the First National Bank of Plymouth . . . Plymouth's Bank. Eligible organizations may submit information about upcoming events to Community Crier by the Thursday preceding the last Wednesday of the month. Call the Crier at 453-6900.



FIRST NATIONAL BANK OF PLYMOUTH

A FIRST AMERICAN BANK 459-9000

Main Office -
535 South Main, Plymouth

Branch Office -
39275 Ann Arbor Road, Plymouth

Richards FINAL

Pre-inventory Clearance

Richard's prices will never be lower than they are right NOW!

UP TO

50% off
ALL WINTER STOCK

Richards entire winter stock is on sale at discounts ranging up to 50% off.

- Jeans • Corduroys
- Sweaters • Polo Shirts
- Sleepwear • Blanket Sleepers • Tops • Skirts
- Coats • Jackets
- Snowsuits • Mittens
- Gloves • Hats • Dresses

Richards

SALE ENDS
Feb. 7, 1982

BOYS and GIRLS WEAR

...because your children are special!

NEW TOWNE PLAZA
Ford Rd. at Sheldon
West Oaks Novi
Farmington • Gd. River at Halstead
Westborn • Michigan at Outer Dr.

After Inventory
CLEARANCE

50% Off

Everything
Must Go

Including
Fixtures



470 Forest Place
Plymouth, MI 48170
Phone: 455-6960
ALL SALES FINAL

For new Main Street facility

Salvation Army breaks ground

BY KEN VOYLES

An hour before the Plymouth Township Planning Commission was to have discussed final site plan approval for the proposed Salvation Army project at 9451 S. Main in Plymouth Township, a group of community dignitaries and members of the Salvation Army broke ground at the site.

The commission went ahead with approval for the project that night (last Wednesday) voting 7-1. Lee Fidge dissented.

The Salvation Army plans to build a single structure on the property, formerly Main Street Baptist Church, for use as the Army's headquarters and community center.

The final plan submitted to the commission came after three months of delay. The item was tabled from the Dec. 9 meeting of the commission at the request of the Salvation Army planners.

The ground breaking took place before final approval, say Salvation officials, because it had been scheduled for that date three months earlier. When the item was tabled in December there was no chance to change the date, said the Salvation Army.

At the ground breaking were Plymouth Township Supervisor Maurice Breen, Plymouth City Manager Henry Graper Jr., Canton Township Supervisor Jim Poole, Capital Committee Chairman, Kal Jabara, Salvation Army Division Commander, Lt. Colonel Harold E. Shoults, Administrative Board Chairman for the Salvation Army, Richard Raison, and contractor Don Bidwell.

The township's planning consultants from Norman Dietrich Associates recommended that final approval be given, while township Fire Chief Larry Groth waived the township's ordinance which says a fire hydrant must be placed within 300 feet of proposed building sites.

Groth waived the ordinance in a letter to the commission, citing a hydrant 480 feet from the proposed building.

A letter from the Wayne County Road Commission was also read into the record. There had been concern over the design of the driveway entrance into the proposed site because of pending plans to widen the intersection at Ann Arbor Road and Main Street.

The letter read, "It appears the reconstruction of the intersection will not take place for some time." Two alternates were then noted; the Salvation Army could reconstruct its driveway before the intersection is changed and alter it afterwards, or wait until construction at the intersection is completed.

As for a lawsuit between the Salvation Army and S & W Hardware, on Ann Arbor Road, that has also been worked out, according to Salvation Attorney Roger Haslick.

The suit concerned the routing of a sewer line to the proposed site that might have adversely affected S & W plans for expansion in the future.

In the final site plan the sewer, which originally would have run through the back end of the S & W property, will now run down Ball Street, just west of S & W, and enter the Salvation property farther south off the street. The line will run through Wayne County right-of-way.

Haslick said he spoke with the attorney for the Smith family, owners of S & W, just



BREAKING GROUND (even if it is in a tub) for the new Salvation Army project at 9451 S. Main are, from left, Plymouth City Manager Henry Graper, Jr.; contractor Don Bidwell; Salvation Army Lt. Col. Harold E. Shoults; Plymouth Township Supervisor Maurice Breen; Canton Supervisor James Poole; Salvation Army administrative board chairman Richard Raison; and Capital Committee chairman Kal Jabara. Site plans for the new complex have been approved, and construction will begin this spring. (Crier photo by Rick Smith)

prior to Wednesday's meeting, and received indications that a settlement was agreeable.

Fidge then suggested to Haslick that the Salvation Army should consider the aesthetic value of the backview of the proposed building because it overlaps into residential property.

Haslick said, "We've met with the neighbors to come up with an agreement over fences and landscaping. We have come up with a compromise to soften the blank walls."

One of those compromises will be lack of windows for the proposed building to

reduce noise pollution, Haslick said.

Donald Gregory then recommended approval of the site plan for five reasons; a sideyard variance was granted by the Zoning Board of Appeals; a conditional use permit was granted; numerous engineering issues had been resolved; the issue of building in two zoning districts had been addressed; and the use of the property will be a more compatible one with the neighborhood.

Construction is scheduled to start this spring. Bidwell's Mardan Construction Company won the contract, also before final approval.

Rouge Watershed books information meeting

Local decision makers, members of planning, environmental, police and fire agencies and interested citizens take note:

A conference on solid and hazardous waste management will be held Friday, Feb. 5 at Schoolcraft College.

Sponsored by the Rouge River Watershed Council, Michigan Department of Natural Resources, Oakland County Executive's Office and Wayne County Planning Commission, the conference will give participants an understanding of needs, options, rights and responsibilities in waste management in light of current legislation.

The morning session, beginning at 8:50 a.m. in the campus Liberal Arts Theater, includes a welcome and introduction by Plymouth Township Trustee and Rouge River Watershed Council Chairman Lee Fidge; a Waste Management Overview; Outlook for Waste Management in Michigan; a talk on the Solid Waste Management and Hazardous Waste Management Acts; Legal Concerns for Waste Management; and morning wrap-up.

After lunch, topics will include The Industry Perspective for Waste Management; Oakland and Wayne

County Update on Solid Waste Management; Role of Local Officials and Citizens in Planning and Siting of Hazardous Waste Facilities (co-presented by Canton Planner James Kosteva); and a wrap-up.

A Police and Fire Personnel Workshop will also be held in the afternoon, conducted by Det. Sgt. Dan Black of the Michigan State Police Fire Marshal Division.

The program will cover topics such as identification and handling of hazardous materials incidents; Federal Department of Transportation classification system; immediate steps to take when faced with an accident, spill or fire involving hazardous substances; and the Michigan State Police Fire Marshal Permanent Identification Numbering (PIN) system.

Registration for the conference must be completed by Jan. 30. A fee of \$12 includes the cost of attendance, luncheon and breaks.

Schoolcraft College is located on Haggerty Road between Six and Seven Mile Roads in Livonia.

For more information, contact Marcie Colling, Rouge River Watershed Council, 9501 Henry Ruff Rd., Livonia 48150, phone 522-4340.

Save more for your retirement and lower your income tax with

IRA

The new tax law now makes it possible for every wage earner, even though they are participating in an employer sponsored pension plan, to tax shelter up to \$2,000 per year in an Individual Retirement Account (IRA). For married couples, where only one spouse is employed, contributions up to \$2,250 can be made in a Spousal IRA. If you and your spouse are employed, you both can open separate IRA's and can contribute up to \$2,000 each in a lump sum or smaller deposits throughout the year. Take a good look at your future. Visit one of our IRA savings counselors today.

Retirement Savings Programs for your IRA Account

18 MONTH VARIABLE RATE ACCOUNT

13.364%

Annual Rate. Interest Compounded Quarterly.

Rate effective Jan. 26 thru Feb. 1

The interest rate on this type of account is paid at a rate equal to the average auction rate on a discount basis for 13-week U.S. Treasury Bills. The certificate rate will be adjusted each week based on the Treasury Bill rate, allowing you to continually earn the highest current market rate available. Minimum deposit for this account is \$100. Additions in any amounts can be made at any time without extending the maturity date of your certificate.

18 MONTH FIXED RATE ACCOUNT

13.000%

Annual Rate. Interest Compounded Quarterly.

Rate is effective until further notice.

The interest rate on this type of account is established at the time the account is opened and will remain the same during the entire term of the certificate. This type of account requires a minimum deposit of \$100 and is opened for a fixed amount. No additional deposits are allowed during the term of your certificate.

30 MONTH MONEY MARKET CERTIFICATE ACCOUNT

12.000%

Annual Rate. Interest Compounded Quarterly.

Rate is effective until further notice.

The interest rate on this type of account is established at the time the account is opened and will remain the same during the entire term of the certificate. The minimum deposit for this type of account is \$100 and is opened for a fixed amount. No additional deposits are allowed during the term of your certificate.

IRS regulations require a substantial penalty for withdrawal prior to age 59½ on IRA plans. Federal regulations require a substantial penalty for early withdrawal from certificate accounts.



Big. But downright neighborly.

Down River Federal Savings

24 NEIGHBORLY OFFICES TO SERVE YOU

HOME OFFICE:
TAYLOR:
20600 Eureka Rd. 285-1010
ALLEN PARK:
6641 Allen Rd. 891-2500
6770 Allen Rd. Dixie
CANTON TOWNSHIP:
12448 Cherry Hill 981-2888
41575 Dixie Rd. 453-1430

CARLETON:
859 Monroe St. 651-8300
DETROIT REDFORD:
24650 W. McNichols
531-4754
FLAT ROCK:
29650 Telegraph 782-1411
GROSSE ILE:
8095 Macomber 675-8330

INKSTER/CHERRY HILL:
29365 Cherry Hill
728-1680
LINCOLN PARK:
3528 Fort St. 866-9400
461 Fort St. Dixie
967 Dixie 882-2396

LIVONIA:
3111 Seven Mile
377-9310
MELVINDALE:
805 Oakwood Blvd.
842-2600
MONROE:
106 N. Monroe St.
213-0000

NORTHVILLE:
127 Huron St. 938-8920
RIVER ROUGE:
261 Burke St. 3100
RIVERVIEW:
17515 Fort St. 285-1010

SOUTHGATE:
1428 Eureka Rd.
285-1010
TAYLOR:
24700 Goldford Rd.
291-9800

TRENTON:
3200 West Rd. 676-2299
WYANDOTTE:
22211 West Rd. 676-1144
WYANDOTTE:
2959 Belle Ave. 285-1010



Member Federal Savings and Loan Insurance Corporation
Your Savings Insured to \$100,000

community opinions



The Community Crier

THE NEWSPAPER WITH ITS HEART IN THE PLYMOUTH-CANTON COMMUNITY

1226 S. Main St.
Plymouth, Mich. 48170
(313) 453-6900

PUBLISHER & CHAIRMAN:
W. Edward Wendover

ASST. TO PUBLISHER:
Phyllis Redfern

EDITOR:
Dick Brown

PHOTO EDITOR:
Robert Cameron

MANAGING EDITOR:
Dan Bodene

REPORTER & SPORTS EDITOR:
Ken Voyles

ASST. SPORTS EDITOR:
David Callahan

BUSINESS MANAGER:
Jackie Pack

CIRCULATION MANAGER:
Joyce Drewry

CIRCULATION ASST.:
Shannon Zebly

ADVERTISING DIRECTOR:
Mike Carne

ADVERTISING CONSULTANTS:

Fran Hennings

Tina Jones

Bill Diesenroth

Salie Roby

Paul Leroue



SALES & DESIGN CONSULTANT:

Cynthia Trevino

PRODUCTION MANAGER:

Nancy Hayes

ARTIST:

Gwen Chomin

KEYLINER:

Kathy Pasek

TYPESETTER:

Karen Sanchez



Recycle your newspapers!

PUBLISHED EACH WEDNESDAY

by the Plymouth-Canton Community Crier, Inc.

CARRIER DELIVERED:

85¢ monthly; \$10 yearly

U.S. MAIL DELIVERED:

\$16 yearly in U.S.A.

Award-winning member:



For Plymouth Township

Supports trash contractor proposal

EDITOR:

This letter is in regard to the letter of Don and Mary Gregory in The Crier on Jan. 20.

First of all, not everybody lives where there is a homeowners association, and if the rubbish collectors decided to raise your rate next month you would have to pay the new rate or look for someone else, like everybody else does, so you do not have as much control as you say.

The Township Board never said the fee would be put on your tax statement. They said, "Could," which is the key word and

everyone should know that to put something on your taxes, it has to be voted by the people.

Township-wide service is of significant importance because not everybody has a choice of rubbish collectors, as in the western part of the township. You get what's there or forget it.

Your homeowners association should have told you that when the people voted to become a charter township some of the stipulations that went along with becoming a charter township was that the township provide police and fire

protection and also provide rubbish removal, so there is no need for putting the issue up for vote again.

I really do not see why people are getting so upset about this issue of contracted rubbish removal, because if it lowers my present bill by about half, as they say it might, I am in favor of it.

Mr. and Mrs. Gregory, if you like the service you are getting now, fine. When the township goes to contracted pick-up at a lower and controlled rate you and your homeowners association can pay your high rate bills while the rest of us enjoy a break for once.

DON HAHN

P.S. The system is working fine in Canton and the city.

Plymouth Jaycettes say 'thanks' for assistance

EDITOR:

During the month of December, the Plymouth Jaycettes conducted a project to aid a "needy family" in the Plymouth-Canton area. Our primary source for the items donated was from local businesses, who were extremely generous even in these hard economic times.

The Plymouth Jaycettes would like to publicly thank those business concerns and professional people who so generously supported our project:

Jerry's Schwinn Bike Shop, T-Station, Old Village Candy Store; Rainbow Connection, Plymouth Fish, Bill's Market, Sideways, Rainbow Shop,

Minerva's Dunnings;

Little Angel's Shop, Children's Bookshelf, Great Shape, Forever Yours Card and Gift Shop, Muriel's Doll House, Static Shop, Penniman Deli, Sports Venture, Designs in Dining,

Ozzie's Guys and Dolls, Pendleton Shoppe, Dr. Donald Davies, Dr. G. Hall, Dr. J. Hendrickson, Dr. D. TeGrottenhous and Dr. Sommerfield.

It's great to live in a community which is so supportive of its fellow man. And thanks, Crier, for your coverage.

JACHIE VACHOW
Vice-President
Plymouth Jaycettes

Post Office window service brings snarls

There is no shortage of excuses for Southeastern Michigan residents to be in a foul mood. There's inflation, unemployment, increase in crime, unusual winter weather, post-holiday mental depression, just to name a few.

For those who try to do business with the Plymouth post office, there is an additional cross to bear in the form of long lines of postal patrons waiting for service at four windows which are usually served by two and sometimes three postal clerks.

Convenience isn't the name of the game when doing business at Plymouth's too small postal facility.

And for those who try to get their postal business done at the end of the afternoon, congeniality and consideration from postal employes is not a commodity in abundant supply.

Some consideration is due those people who get in the front doors before the five o'clock deadline, spend some time standing in line and then are unceremoniously chopped off before getting to the windows and are told to clear the lobby.

The ire of the postal patron is not only raised by the 20-cent postage stamp. It is also raised by the handful of postal workers who think the public works for them.

Police should stop Main St. speeding before disaster strikes

EDITOR:

The City of Plymouth Police Department seems to be lax in catching the speeders along Main Street, north of Ann Arbor Road.

This is a serious problem because of the senior citizens in the area and the school students who cross Main Street. I have actually witnessed cars traveling at 35 to 45 miles per hour, ignoring the posted speed limit of 25 miles per hour and knowing full well that the Plymouth Police Department will not touch them because they are ignorant of the problem.

I fear that if the situation is not resolved in the near future, a very serious accident might occur caused by two factors—the ignorant driver and the questionable Plymouth Police.

ANDREW D. TURNER

Plymouth Jaycees appreciate coverage of alcohol program

EDITOR:

On behalf of the Plymouth Jaycees, I would like to thank you for the excellent press coverage the newspaper gave us for our Alcohol Awareness program featuring Fr. Vaughn Quinn from the Sacred Heart Center in the Jan. 13 edition.

Our program was an overwhelming success. We had in attendance approximately 250 people which is the largest attendance we have ever had for one of our monthly meetings.

NICHOLAS E. SMITH
Program Chairman



I'VE BEN SNOWD

BY MARC AUNE

EDITOR'S NOTE: This guest cartoon was submitted by Marc Aune, the regular cartoonist of the "Island Reporter" of Sanibel Island, Fla. — one of the several newspapers from around the country with which The Crier swaps subscriptions and ideas.

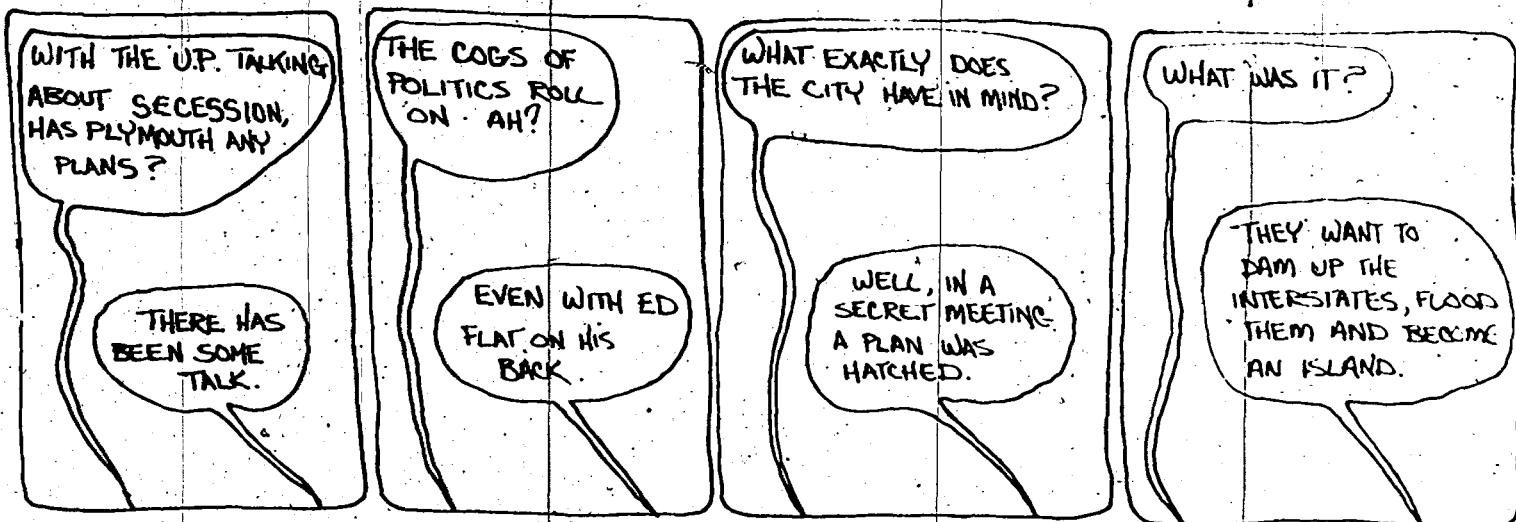

Who is going to run for what?

Politicians start jockeying for races

John Hopkins of Banbury Cross is about to get some competition.

Not to his horse and carriage business, but to the proof his carriage trade has been up and down the streets of The Plymouth-Canton Community. Soon, those little steaming piles left by his horses will have lots of company.

IT'S ELECTION YEAR, FOLKS.

It won't be long before the Manure Spreaders are out in full force.

Politics are getting an early start this year because of the reapportionment and redistricting based on the 1980 census which showed great population shifts here and elsewhere.

That's why you've already begun to see the politicking and the manure spreading.

It hits at all levels.

Let's start with the Plymouth-Canton scene itself.

This is the first even numbered year that township officers and half the trustees aren't up for election. That law was changed so that when the current township officials ran two years ago, they all won four-year terms.

While this might cut down on the total number of elected seats up for grabs (and, therefore the total number of hopefuls out shaking the bushes), it gives all the incumbent township types a clean shot at someone else's seat.

Therefore, Gerry Law, of the Plymouth Township board, can take a safe run at the new state representative district being created for Plymouth and Plymouth Township by his hard-working Milliken crony Bob.

And, since the new Wayne County districts throw current County Commissioner Bill Joyner up against Mary Dumas (who Bill thinks he'd lose to), he'll run for state representative.

That throws prominent local GOP Law (not to be as confused with his brother as they'd both like) in with prominent local Democrat Joyner — plus whatever other folks we might get, like maybe Woody Lynch.

Law says to some he's not running. If not (and time will tell) the Republicans will try hard to put up a strong Plymouthite for the new district. Would Maurie Breen run?

And there're the probable TWO state

With Malice Toward None

By W. Edward WENDOVER



representative districts that Canton may get carved into. Would Tom Yack, current Plymouth-Canton School trustee, run?

Certainly Don Rusnock, young president of the Wayne-Westland School Board, will run. Will Incumbent Tom Brown run again? How about a Bob Greenstein, Harold Stein or a Noel Culbert — all former Canton supervisors without a place to politick anymore? (Doug Ritter is moving and won't run.) So much for the Democrats.

There'll be a Republican or two, no doubt. Would Loren Bennett or Flossie Tonda run for state rep?

And what of the new county district into which Canton has been thrown? Would Charter Commissioner Bart Berg (a GOP stalward) run? How about Dick Wolfe?

And then there's the Wayne County executive spot.

Most certainly Livonia Mayor Ed McNamara will be an instant front runner upon jumping in. Will his frequent Saturday morning visits to the Mayflower Hotel round table's "Gloom and Doom Society" produce local support?

And then there's Congress.

Although the new districts aren't drawn up, both Incumbents Carl Pursell (who represents Plymouth-Plymouth Township in his district) and Bill Ford (whose district includes Canton) see the new district lines running down Joy Road. Who will run against them?

Would Democrat Phil Power stoop to a try at Carl's seat or will Kathleen O'Reilly pretend to be a local district resident again and take him on once more? Or, to add a ridiculous factor, would Carl switch parties this year since he votes like a Democrat anyhow?

Will James Caygill, the Woodhaven police chief, be in the race again as a GOP? Would Grieta Poole let her supervisor-husband run?

Dropped in between all the other politicking as well are the annual school

elections in June. Will Board President Carol Davis seek reelection? How about board member Elaine Kirchgatter?

And what challengers may try it? Will Ernie Rumsby run for school board AND Wayne County Commissioner? He brags that he'd try to put that over. Will former School Board Member Steve Harper run again?

But even without that, the 1982 political season is open. Be careful where you step or you'll get your shoes dirty.

At least John Hopkins is polite enough to carry and use a shovel for his horses' droppings.



Coloring it Brown

By Dick Brown

In the Plymouth-Canton Community public officials are making a concerted effort to keep the residents informed about the various governmental operations.

The Plymouth-Canton School Board had a public forum a couple of weeks ago. The Plymouth-Canton Community Schools Council, an informational group representing each school in the district, has a series of public forum meetings set for February and March to inform the public, particularly parents, on school issues, some of the present and future problems and possible solutions to those problems.

In Canton Township Supervisor Jim Poole has scheduled a "State of the Township" meeting for Feb. 3 in which he, along with township department heads and representatives from Wayne County Road Commission and other county officials and state lawmakers will discuss problems, conditions and solutions to problems with the residents.

In addition, Plymouth City Commission meetings, Plymouth and Canton Township meetings and school board meetings are regularly open to the public.

Unfortunately, very few people avail themselves of the opportunity to attend these regular meetings. Audiences at most city commission, township and school board meetings are composed of department heads, administrators, the press and a handful of people wanting something or fighting something.

The Plymouth-Canton School Board open forum was a classic example. A relative handful of about 40 people showed up for a well-publicized meeting billed as informational. Chances are that Canton's public forum on Feb. 3 will not play to a full house.

Yet there are always great numbers of people who voice opinions on how local government is being conducted and how local services are being delivered. Unfortunately those opinions are wasted over the morning coffee break, across the bridge table, in the bowling alley or during the commercial break in front of the TV set.

community opinions

In Crier citizen survey

City-Township police pact loses

"I would pay more for police service but not for the police we have now. They can't handle the job."

"Let the township take care of its own residents. They don't want us. Thievery has been on the rise in our neighborhood since the police don't come by."

"I view this questionnaire as an indirect attempt to raise the issue of sheriff's patrol, which I do not want. They cost too much for services rendered."

"We have a scanner and know how busy and prompt the police are."

"The township should carry more of their share of the costs for hiring officers. Plymouth Police did an outstanding job before contracting with the township. Now they are overloaded."

"When the deputies were patrolling we saw cars on a regular basis. I have never seen a Plymouth Police car in our sub."

"The police service in Plymouth Township has gone from excellent to poor, at best. When we had the sheriff's department the people received not only prompt service but continuous patrolling of our community. The city police have, if they are doing their job, all they can handle in the City of Plymouth."

"We've been hit five times by vandalism-punctured tires, beating on door and wrecking locked gas cap."

"The present police force is totally inadequate to do the job for both city and township. Now we are seeing some terribly bad management decisions, all of which frighten me."

"The shared police service has its good and bad points. But let's not get carried away. The proper amount of service to every area would be worth a little more."

They're all Girl Scouts

EDITOR:
The Girl Scouts of the Plymouth-Canton area have always appreciated the coverage and publicity provided by The Crier. Because of this previous excellence I was very disappointed to see the erroneous and misleading information in your article on the cookie sale.

In the first place, all our members are Girl Scouts. Brownies are Girl Scouts; as are Juniors, Cadettes, Seniors and even adults. We have one organization with four program levels; therefore a Brownie troop is a Girl Scout troop.

Secondly, in Huron Girl Scout Council,

EDITOR'S NOTE: In response to the 10-question survey on police services in the Plymouth Community published in last week's Crier, most respondents said they wanted more police protection and that they are willing to pay for the increase.

The survey was not intended to be used as a scientific random sampling -- since, obviously, only those most concerned with police protection responded. It was meant to show at least some sentiment of the residents of the city and township of Plymouth whose communities are now renegotiating their shared police services contract.

Out of 34 responses to The Crier survey (plus a number of letters to the editor which are condensed here): 66 per cent were township residents, 34 per cent city dwellers; 27 per cent said they saw regular police patrols in their neighborhoods, 73 per cent said they didn't; 75 per cent of the respondents said they'd had a need to call police (city and county police had been called about equally), the remainder hadn't; 67 per cent of those calling police said they responded promptly, the others said no; slightly more than half those needing police needed some type of follow up and felt it adequate, half who needed followup felt it inadequate; almost all responded that they knew of others who had called upon police.

Twelve out of 34 answering the survey wanted the city and township to continue sharing police while 22 did not. Twenty nine out of 34 said they wanted police protection increased (26 of them said they did not feel secure) and 19 said they were willing to pay more for police, two said they wanted to pay less.

The survey was run to seek out additional input for city and township officials in their deliberations on police. Two Plymouth Township residents, who told The Crier they were dissatisfied with police followup on their cases, had been told by officials that police protection was adequate and efficient, but they felt otherwise and agreed the survey might help seek out others' opinions.

"I think we should go back and contract with the Wayne County Sheriff for patrol. It is my opinion that the city cannot do the job it was contracted to perform. I think this contract with the city was cut and dried before the sheriff's patrol got in trouble. Now that the deputies are out of trouble, let's get off our duffs and get professionalism back and send the city's Keystone Cops back where they belong."

"I feel we need to review the services we are now receiving for \$270,000 plus the \$50,000 extra we are being billed for and compare what we would receive for \$320,000 from the Wayne County sheriff. I resent the township officials thrusting the Plymouth Police at us without having more resident representation in the matter. Many of us feel it was a political maneuver to help the city."

"I have no serious criticism of the city police protection except the infrequent patrols, but if I were given a chance to vote for my choice of police protection, I would vote for a return of the sheriff's patrol."

"We were better off before. The Plymouth Police belong in the city. The township should be responsible enough to end the infringement on the city's services."

"Bring back the Wayne County Sheriff's Patrol. At least we saw them on township roads now and then."

"I feel the township is keeping the city police force intact (avoiding layoffs, etc.) and they are not doing the job, especially in rural township."

"The Plymouth Police, like the Township Board and Breen, leave lots to be desired. Our community has gone down from great to terrible-lousy."

"My taxes in the township went up for police-and I didn't get it."

"We feel Wayne County Sheriff's Patrol is needed. They were a highly visible deterrent to crime."

"I vote NO for combined services. I never see a car in my area. When Wayne County was responsible for my safety, at least once a day a car would drive by and the officer would wave a hand."

"If my memory is correct, the township people paid \$280,000 for protection by the Plymouth Police. I've seen the Plymouth Police drive down 5 Mile and south on Haggerty a few times. I have at no time seen them drive through our subdivision. I don't call that protection. Bring back the county sheriff's deputies. They were terrific and they earned their money. Crime also went down. Since the Plymouth Police got in the act crime has gone up. The Plymouth Police haven't earned anything."

In addition

by Dan Bodene



It's Michigan Educational Assessment Program evaluation time.

According to what I see in the results, Plymouth-Canton kids in 4th, 7th and 10th grades who were tested didn't score as well this year as they did last year. But, the district did better overall among the Wayne, Oakland and Macomb County area.

Consider a few things. There were fewer kids tested this year in the Plymouth-Canton district and Dave Rodwell, administrative assistant for research and data processing, also says local students had significant problems with the test format in some areas.

The state, you see, tests on what it thinks kids should have learned by the time the MEAP test is taken. Seventh graders may be tested in the fall on geometry, for example, although that unit isn't taught in the district until spring.

Consequently, the results are skewed a little when you compare them with other districts. The alternatives are to rearrange the sequence of learning or concentrate on more comprehensive reviews before test time.

Besides, the idea of the test is not so much for comparisons between districts, but to measure performance against a set of standards set by the state.

Rodwell says one of the evaluation functions is to allow schools, homerooms and even kids to be identified when a significant trend is spotted. Good and not-so-good trends.

I'm not particularly worried that the MEAP scores were lower in Plymouth-Canton this year, when compared with our own scores last year. As much as I know at this point, there are too many variables which may have affected the percentiles without affecting learning.



Central lot goes modern with coin-operated gate

Parking in the City of Plymouth's Central Lot is going to cost residents and non-residents alike 25 cents for a full day.

City Commissioners approved the new rate two weeks ago after the arrival of an electronic entry machine. Formerly it cost 20 cents per hour for the metered lot.

With the new machine, people wishing to use the lot will have just a one-time fee, either a quarter or a token.

There is no charge to use the lot at this time. The new charge will go into effect on Feb. 1. The recently purchased equipment makes the new fee possible, say city officials.

There will be no charge to use the lot on Sundays. A yearly pass of \$6 will also be made available, as will tokens for employes of shops off the Central Lot.

The new machine eliminates the need for two parking attendants at the lot.

In the future, the city will consider creating a loop in the lot so that delivery trucks may pass through without paying the all day rate.

Along with the new entrance machine the city put up a wood carved sign last week announcing the new rate. The new sign had to be changed twice to get the correct wording, according to city DPW officials.

The first sign called for a 50 cent fee. There was also some confusion over the wording on the bottom of the sign, "2 exit lot." The sign was reworded to read 25 cents and "To exit lot."

Each sign was made in the city DPW shop and cost approximately \$135 to create.

Pinetree Dental Center



We work for your smile!

455-2890

WINTER REDUCTION SALE NOW IN PROGRESS

35% to 50% off



The **BEFORE & AFTER** Shoppes Ltd.

Maternity, Layette and Toddlers

863 W. Ann Arbor Trail
Plymouth, Mi. 48170.

M-T-W-S 10-6
Thur. 10-8 Fri. 10-9

453-3580

Our Stuff sale

The grown man's equivalent of being locked in a candy store . . .

- Winter Stuff-** scarves, gloves, hats, coats - at least 30% off-even the prices will warm you
- Summer Stuff-** this you've gotta see-last summer's leftovers-50% off-some winners-some real losers too.
- Dressy Stuff-** great looking Hart, Schaffner and Marx, Austin Reed, and Gordon and Hunt suits and sportcoats 25%-40% off-Nope, no charge for alterations.
- Casual Stuff-** sweaters-sportshirts-35% off. Even a beach pant for ten bucks.
- Damaged Stuff-** too lazy to pack it up and send it back-you can have it for a steal-nothing serious like sleeves missing.
- Soiled Stuff-** toss it in the washer-maybe twice-it'll be like new.
- Pant Stuff-** 30%-50% off-no reason to get caught with your pants down.
- Tie Stuff-** some too wide, some too ugly, some not bad-priced to move-buy some for your enemies.
- Stuff Stuff-** one of these two of those-like a Nehru Jacket, a couple of leisure suits, two left hand gloves-to name a few.

We know some otherwise restrained and dignified gentlemen who go slightly crazy during our Pre-Inventory Stuff sale every January.

fred hill's

John Smith

CLOTHING COMPANY

336 S. Main, Plymouth • 455-2040
Thurs. & Fri. till 9

*Closed Tuesday, February 2 for inventory

friends & neighbors

Community joins in "super" spirit

BY W. EDWARD WENDOVER

"You've got a neat town, but it's kind of quiet."

That was the concensus of a group of San Francisco 49ers fans who stayed in Plymouth for Sunday's big game.

Standing in the concourse behind their seats in section 109 of the Superdome - definitely in 49ers territory - the Plymouth guests were more intent on partying than on watching the game.

The fans said they'd mostly hung out at the Steak and Ale (the closest watering hole to the Red Roof Inn where they were staying), the Mayflower Hotel and the Hilton Inn. There were "lots of us 9ers" at the Mayflower, they said, but "Why were there so many people from Texas at the Hilton?"

At least one local femme fatale made a good representation of town (the chamber of commerce might want to hire her), one of the 49ers fans swore he was coming back to Plymouth to visit her when he had more time.



EVERYBODY ENJOYED the super Super Bowl XVI parties Sunday evening at home, at the local saloon, or at the stadium in Pontiac. A few examples: top right, a house party in Canton; bottom right, this year's New York Giants star quarterback Phil Simms is introduced during the Home Box Office private company party at the Plymouth Hilton; and below, fans in the Box Bar in Plymouth cheer both teams on -- all they wanted was an exciting event, and they got it. (Crier photos by Robert Cameron)



SUPERBOWL XVI

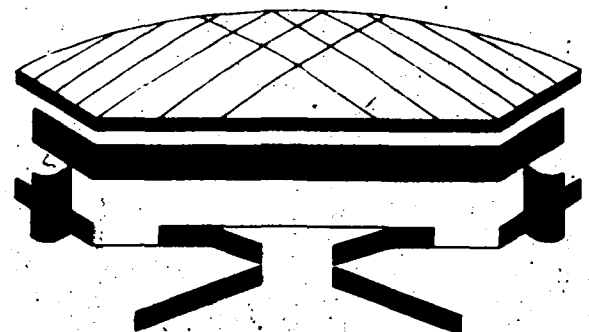

tell it to Phyllis



Isn't it fun to live in Michigan in the winter? Those people who move to Florida for three months don't know what they're missing.

Just think of all the fun we would miss if we didn't have snow to play in. We couldn't ski or hop on a sled and ride down the hill, and we wouldn't get the exercise of trying to shovel that beautiful white stuff off sidewalks and driveways.

I'm sure we would all miss the challenge of trying to drive on ice and snow covered roads. It's such a thrilling experience when you come to a stop sign, apply the brakes and suddenly the car has a mind of its own as it heads directly for the stop sign or decides to go down the street sideways.

Driving through little snow drifts isn't any big deal, we all do it a lot during the winter. It's surprising how quickly a little drift can become a huge mound of snow when you find your car embedded in it. Backing out of a driveway can become a real pain in the neck, not to mention embarrassing, when you have to ask a couple of nice gentlemen to come out in the cold and help free your car from a snow bank.

When the temperature dips below zero and the wind is howling, it's nice to build a warm fire in the fireplace. Okay, so the wind blows the cold air down the chimney and maybe a fire wasn't such a good idea after all.

If you think I'm a little envious of people who go south for the winter, you're right. But look at it this way, they can't possibly appreciate and enjoy spring nearly as much as the rest of us.

Milt and Roberta Orr (formerly of Bill's Market - now of happy retirement) will be on a cruise through the Panama Canal soon.

Bill Silvis, former city commissioner, was back in town for the holidays.

Sheila Rorabacher, daughter of Mr. and Mrs. Robert Rorabacher of Lindsay Drive in Plymouth, received a 4.0 last semester at Aquinas College in Grand Rapids. She is a junior majoring in accounting and business administration.

Mary Bammel of Canton, a student at The University of Michigan-Dearborn, is listed in the 1982 edition of "Who's Who Among Students in American Universities and Colleges."

John Jan Pouch of Canton received his Ph.D. degree in physics from Wayne State University in Dec. He is the son of Mr. and Mrs. Aleksander Pouch of Canton.

Local students attending Oberlin College in Oberlin, Ohio, who are active in the actors and musicians touring group are: Brian McAninch of S. Sheldon in Plymouth; Sunghee Park of Dorian Dr. in Plymouth; Stan Jenkins of Drury Lane in Plymouth; Sharon Ross of Bricklan in Canton; Mandie King of Ann Arbor Trail in Plymouth; and Anne Harrington of Blunk Street in Plymouth.



Dinner Special

Offer good Monday through Friday only
4 p.m. to closing

Your Choice

\$1.99

• Taco, Fries & Coke reg. \$2.70

or

• Coney dog, Taco Salad & Coke reg. \$3.00

Chris' Coney Island

Great Scott Shopping Center
Ann Arbor Road at Sheldon

455-6161

Hours
Mon.-Fri.
9:30-8 pm
Sat.
9-7 pm

Carry Out Service
Homemade Soups Served Daily

DOLLAR DAYS SALE

continues next week

SAVE 40 to 60%

Corduroy Pants & Jeans \$8	Brushed Sweaters \$6
Corduroy and Velveteen Blazers \$18	Leather Belts 2 for \$3

• ALL ITEMS MARKED IN RED ARE FINAL SALES •

UNIQUE *fashions*

Plymouth Square Shopping Center
(Corner of Ann Arbor Road and Sheldon Road)

44515 Ann Arbor Road
Plymouth 459-1010

Everyday Savings at 15% 60%
Layaway and Exchange Privileges

Winter Hours
Mon. thru Wed. 10-7
Thurs.-Fri. 10-9
Sat. 10-7 Sun. 12-5

Get the most from your IRA/Keogh dollars

If you are already a qualified IRA participant or if you are one of the millions of Americans who are eligible to participate in IRA plans beginning Jan. 1, 1982, you are presently facing many decisions about how to get the most for your dollar.

You're concerned about the rate of return as well as the safety and security of your investment. Therefore it is important that you carefully select the institution to which you will entrust your funds.

COMMUNITY Federal Credit Union has been serving the financial needs of people living or working in the Plymouth area since 1958. Gradually our field of membership has been expanded to include people living or working in the Northville and Canton areas. Account insurance to \$100,000 by a federal agency and a history of sound financial management are testimony to COMMUNITY Federal's ability to safeguard your IRA.

So, to get the most for your IRA dollars, as well as a full range of financial services, stop in or call either office of COMMUNITY Federal Credit Union. You may begin your IRA program with a modest initial deposit of \$10.00. Monthly compounding of dividends is automatic for account balances of \$500 or more. Our Member Service representatives will be happy to help you.

And tell the tax man to wait.

COMMUNITY Federal Credit Union

500 S. Harvey
Plymouth
453-1200

101 N. Center
Northville
348-2920

Each member account insured up to \$100,000



15%-50%
on everything in
store . . .

Wicker Warehouse
689 N. Mill
459-2990

KEROSENE
We stock the low sulphur
kerosene needed for
kerosene heaters.

SAXTONS
GARDEN
CONIST inc. 587 W. Ann Arbor Trail
Plymouth • 453-6250

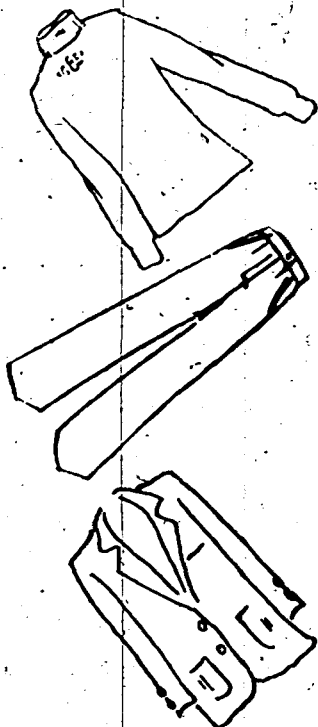

we will be closed for
inventory Tuesday,
Feb. 2, so please
take advantage
of our

**Pre-
Inventory
Markdowns**

Thursday, Friday,
Saturday, Jan. 28, 29, 30.

me and mr jones
Mayflower Hotel 459-4900

18 what's happening

To list your group's event in "What's Happening" merely send the information (in writing) to: THE COMMUNITY CRIBER, 1226 S. Main St., Plymouth, Mich. 48170. Information received by NOON MONDAY will be used in that Wednesday's paper (space permitting.)

WEIGHT WATCHERS

Weight Watchers meet at the Plymouth Cultural Center, 525 Farmer, on Tuesdays at 9:30 a.m. and on Thursdays at 6 and 7:30 p.m.; and at Canton Calvary Assembly of God, 7933 Sheldon, on Mondays at 7 p.m. For more information, call 557-5454.

WILLOW CREEK CO-OP NURSERY

On Feb. 9 at 8 p.m. Willow Creek Cooperative Nursery will sponsor David Figertl, who will speak on "Stress and Family." The meeting will be held at Geneva Presbyterian Church on Sheldon Road.

CANTON NEWCOMERS

Canton Newcomers will meet on Feb. 3 at 7 p.m. at Pioneer School, 46081 W. Ann Arbor Rd. A games night will be featured, including Bridge, Bunko, Pinochle and Uno. Participants should bring an hors d'oeuvre. Anyone living in Canton is welcome. For more information, or if transportation is needed, call Marge Pogelnicki at 397-0062.

SPOON RIVER ANTHOLOGY

A performance of "Spoon River Anthology" and a bluegrass music presentation by students from Oberlin College, Ohio will be held at Canton Little Theater on Feb. 2, with bluegrass from 8:12 to 9:15 a.m. and Spoon River Anthology from 10:15 to 11:20 a.m. and from 1:10 to 2:05 p.m.

PLYMOUTH AAUW BRANCH CHILDREN'S DRAMA

Plymouth Branch of the American Association of University Women will present its 22nd annual live drama for children, "Pinocchio," on March 4, 5, 6 and 7 at Salem High School Auditorium. Tickets are available at Plymouth-Canton Elementary Schools or by mail by writing Plymouth AAUW Play Tickets, 44759 Brookside Dr., Plymouth, MI, 48170.

DAR GOOD CITIZENS LUNCHEON

The Sarah Ann Cochrane Chapter of the DAR will have its annual Good Citizens luncheon at the Plymouth Historical Museum at noon on Feb. 15. Honored guests will be the high school senior winners of the award and their mothers.

VOCATIONAL CHILD CARE OPEN HOUSE

An open house for parents of pre-schoolers will be held to discuss vocational child care classes, on Feb. 3 from 8 a.m. to 2 p.m. in the Child Care Center (off Room 138) at Canton High.

MAYFLOWER GARDEN CLUB

Members of the Mayflower Garden Club will meet on Jan. 28 at 10 a.m. at the home of Beverly Kuczynski. Programs for 1982 will be discussed followed by lunch at Steak and Ale.

SMITH SCHOOL SPAGHETTI SUPPER

Smith Elementary will hold its annual spaghetti supper on Jan. 29 from 5 to 8 p.m. Spaghetti, pizza, cole slaw, dessert and a beverage will be served.

GIRL SCOUT WINTER MEETING

Registered Girl Scouts of the Plymouth-Northville-Canton Area Association are urged to attend the winter meeting on Jan. 27 at 7 p.m. at West Middle School. A vote will be taken to elect delegates to the annual council meeting, and a recommendation to the Board of Directors for the Area Chairman will be given.

SOLAR ENERGY CLASS

Registration is open for a Solar Energy class at Schoolcraft College, to meet Tuesday evenings beginning Feb. 2. Instructor Penny Wright, chairperson of the Michigan Solar Energy Assn. will offer an up to date look at solar energy use, including active and passive heating systems, solar retrofits, greenhouses and sunspaces, photovoltaics and solar tax credits. For more information, call 591-6400, ext. 409.

AARP ELECTION

The Plymouth-Northville Chapter of the American Association of Retired Persons will meet Jan. 27 at the Plymouth Cultural Center, 525 Farmer, beginning with a board meeting at 10:30 a.m., with brown bag lunch to follow. Election of new officers will begin at 1 p.m. Please bring cards, checkers, backgammon or similar games for the social period following.

THE HARD CORP SINGERS

The Hard Corp Singers will perform old time rock and roll on Feb. 5 from 9 a.m. to 1 p.m. at the Oddfellows Hall, 344 Elizabeth, Plymouth. \$5 donation is asked. Free beer. All proceeds to benefit the Plymouth Indian Center. For more information, call Rick Smith at 453-8220.

NETWORKING

An organizational meeting for the YMCA-sponsored series "Networking" will be held Feb. 9 at 7 p.m. at the Hillside Inn restaurant. Cost is \$3, and includes wine and light hors d'oeuvres. Purpose is to share experiences and resources to support career endeavors. Goal is to build a working network system. RSVP by Feb. 1 by calling 453-2904.

FOLK DANCE CLUB

The Folk Dance Club will meet Jan. 29, Feb. 26, March 26 and April 30 from 7:30 to 9:30 p.m. at Bird School, Sheldon and Ann Arbor Trail in Plymouth. Everyone is welcome. For more information, call 453-2400 after 5 p.m.

WILLOW CREEK COOPERATIVE NURSERY

Willow Creek Cooperative Nursery will be accepting applications for 3 and 4 year olds (Children must be 3 by Dec. 1, 1982) for the 1982-83 school year, on Feb. 1 beginning at 9:30 a.m. at Geneva Presbyterian Church, 5835 Sheldon, Canton. There is a \$5 registration fee. For more information, call Carol Waugh at 981-1757.

PLYMOUTH LIONS PISTON BASKETBALL NIGHT

Plymouth Lions Club will have a Detroit Piston Basketball night Wed., Feb. 3 when the Pistons play the Boston Celtics. Regular \$9.00 tickets will be sold at half price. Children under 15 will receive a free sports bag.

SNOWSNAKE TOURNAMENT

The 4th Annual Snowsnake Tournament will be held Feb. 6 at Central Middle School. Registration begins at 9 a.m. Also featured will be open drum competition, and pot-luck dinner (participants are urged to bring a dish to pass). Traders and dancers welcome. To register, call Rick Smith at 453-8220.

CHILDREN'S VALENTINES PARTY

Canton's Parks and Recreation Dept. is sponsoring a free children's Valentines Party for kids ages 3 to 12, held on Feb. 13 from 10 to 11:15 a.m. at the recreation building, on Michigan Ave. at Sheldon. To register, call the Rec Dept. at 397-1000.

WOMAN'S CLUB OF PLYMOUTH

Ernest Doumochelle of the Art Galleries in Detroit will give a slide presentation on antiques and auctions, at the meeting of the Woman's Club of Plymouth on Feb. 5 at 12:30 p.m. Tea chairperson will be M.J. Willette.

DUNNING-HOUGH LIBRARY TODDLER STORYTIME

Dunning-Hough Library Toddler Storytime will be conducted on Tuesday mornings at 10:30 beginning Feb. 16 and ending March 23. Registrations can be made in person at the Library on Feb. 9.

GOING OUT OF BUSINESS

• LOST OUR LEASE •

7 MILE 1375
2 Minutes West of I-275
42301 West 7 Mile Road

Permit No. 820001
MASTERCARD-VISA-BANKLINE ACCEPTED-DELIVERY AVAILABLE
NO REASONABLE OFFER REFUSED

EVERYTHING MUST GO!

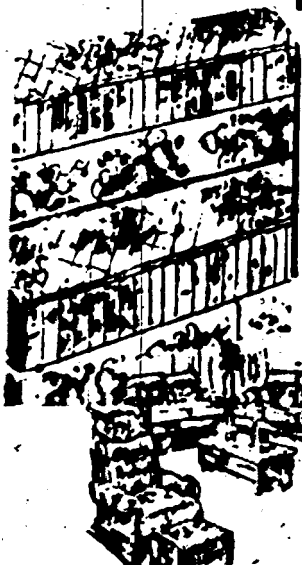

Rustic pine and Herculon 3 pc. country room. Sofa, loveseat & chair included.
\$499 Value \$279

**1/2 OFF
ON NAME
BRAND
BEDDING**

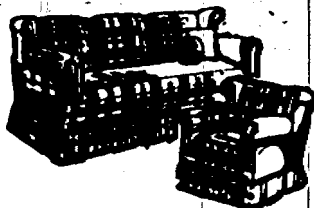

Early American, high-back sofa & chair in a smart, Herculon cover. Tufted.
\$459 Value \$299



Beautiful maple grain formal top table & 4 padded chairs with chrome base.
\$299 Value \$199

NORTHVILLE STORE ONLY



NORTHVILLE
42301 W. 7 MILE
Northville Plaza Shopping Center
HOURS:
Mon-Sat 10:00-9:00 PM
Sunday 12:00-5:00 PM

348-9821

The Contemporary & Bride

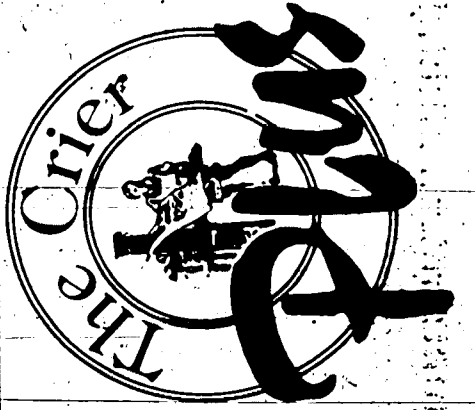



**Classic
Wedding Elegance . . .
create memories that last a life time.**

**Spring Bridal
Fashion Shows**
Sunday January 31st
Tuesday Feb. 16th
Call for information
455-4445 769-1666

Genera's of Plymouth
Bridal Shoppe

**2 locations for your
convenience**

#17 Forest Place
Plymouth, MI 48170
(313) 455-4445

3584 Plymouth Road
Plymouth Green Shopping Ctr.
Ann Arbor, MI 48105
(313) 769-1666

Le Gault's
OF PLYMOUTH

original floral designs.especially
for your wedding in Silk Flowers
(Next door to the Mayflower Hotel)
853 W. Ann Arbor Trail
455-3850

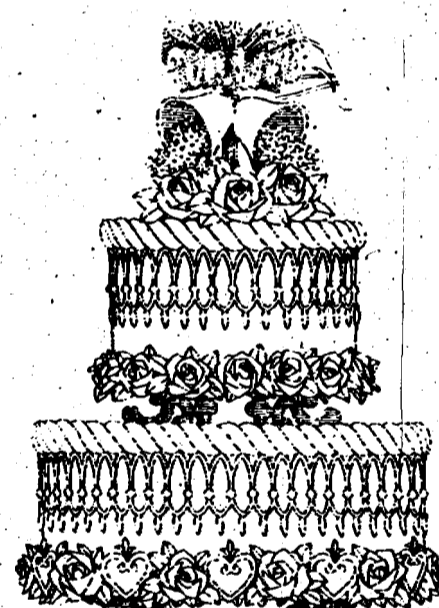

Create a Cake

44286 Warren
at Sheldon
Canton Mi.
455-1240

Hair Fashions & Make up

**BEAUTIFUL PEOPLE
HAIR FORUM**

550 FOREST AVE.
PLYMOUTH, MI • 459-2880

Bridal shows add ideas for prospective couples

A lucky couple will have more than memories of the bridal shows held at the Plymouth Hilton recently.

Kathy Kellogg and Jeff Faigle, who plan to be married in October, are the grand prize winners of a whole stock of gifts donated by the consortium of merchants who sponsored the shows.

The event, held Sunday, Jan. 10 in a ballroom donated by the Hilton, featured two shows displaying a full range of wedding accoutrements, from bridal gowns to a honeymoon trip to Jamaica. And the future Mr. and Mrs. Faigle will be able to enjoy them all.

Merchants who displayed at the show, and the gifts they presented to Kellogg and Faigle, include: Geneva's of Plymouth, bridal gown ensemble; Valente's, tuxedos; Beautiful People Hair Forum, hair, nails and makeup; Create-A-Cake, wedding cake; LeGault's of Plymouth Bridal Flowers, flowers; Engraving Connection, gifts; O and D Bush Jewelers, earrings; James Rawlinson, photos; Port-to-Port Travel, flight bags; Don Massey Cadillac, limousine service; Big Red Q, donated tickets; Van Dam's Lingerie, gift certificate; Green Thumb, gift certificate; Lena's, gift certificate; Eastern Airlines, trip to Jamaica; Plymouth Hilton, accommodations in Jamaica.

Kellogg, a Canton resident, is employed by Providence Hospital as a student x-ray technician. Her fiancé, a Dearborn Heights resident, is employed at Republic Tool and Die Company. The couple have been steady companions for three and a half years, and became engaged in October. The big date is set for Oct. 16 this year.

There are also two upcoming bridal shows, for prospective newlyweds who want another chance to see the full gamut of wedding accessories.



One will be held Jan. 31 at the Holiday Inn West Bank in Ann Arbor, with shows at 1 and 4 p.m.

Another will be an annual show held at the Mayflower Meeting House in Plymouth, on Feb. 16 at 7:30 p.m.

Details and tickets for both shows are available at Geneva's of Plymouth, 17 Forest Place, Plymouth.



KATHY KELLOGG and Jeff Faigle have a lot to smile about -- at a bridal show held at the Plymouth Hilton they won a whole list of goodies from local merchants, sure to make their wedding a gala affair. The couple were engaged in October, and are already busy with preparations for the big ceremony this fall. (Photo courtesy of James Rawlinson)

RAWLINSON PHOTOGRAPHY

543 Leicester
Plymouth, MI 48170
453-8872

It is through the photographer's eyes that the bride will remember her wedding... his eyes, his heart, his talent, and his ability to relate to the wedding participants.

Therefore it is perhaps necessary that more care be taken in selecting her wedding photographer than any other decision relating to her wedding plans.

Rawlinson Photography is an aggressive, growing, family business with a reputation for excellent photography. It is our goal to be the best at what we do. Therefore, we take time each year to participate in seminars with world famous photographers from the United States and other countries.



Because you will probably never look more lovely than you will on your wedding day, we will capture your loveliness with a variety of techniques, including multiple exposures, romantic lighting, soft focus effects, and of course, the traditional beauty of the Classic poses.

Your wedding will be one of the truly great occasions of your life, and long after the wedding day, your professional wedding photographs will be among your most treasured keepsakes. Picturing a day so special is too important to trust to anyone but a professional photographer. Well-meaning family or friends are not familiar with the special techniques and the pressures of wedding photography. Disappointment is too high a price to pay for the loss of pictures that cannot be duplicated.

At Rawlinson Photography we are wedding specialists, and you can depend on us to capture the true beauty of your formal portraits, the ceremony itself, and the joy and the excitement of your entire day.

Wishing you the loveliest of weddings.

Jim, Larry, Pam, Pat



Men's Formal Wear
Over 20 locations to serve you better

Pre-Registration Special

Valente's



20% Discount

This coupon entitles the bearer to a 20% discount on the purchase price or the rental fee of any merchandise. This offer good through June 30, 1982.

Valente's MEN'S FORMAL WEAR

29107 5 Mile Rd., Livonia, 48150
500 Feet East of Middlebelt
Store Manager Douglas Montgomery
522-8830

We are
**Honeymoon & Anniversary
Experts . . .**

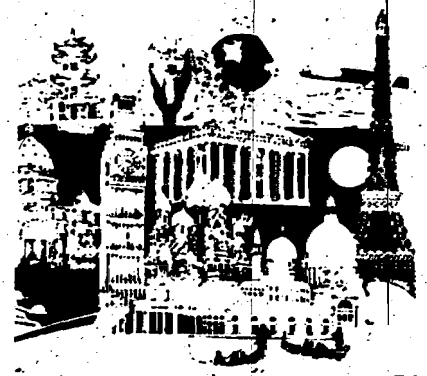

Complete Travel Services

We're professionals at helping make your
business & vacation trips perfect.

PERSONAL ATTENTION ALWAYS FROM:

Port to Port Travel Company

Computerized Service available now



238 S. Main St.
Plymouth

453-4100

Mon.-Fri. 9-5. Sat. 10-2

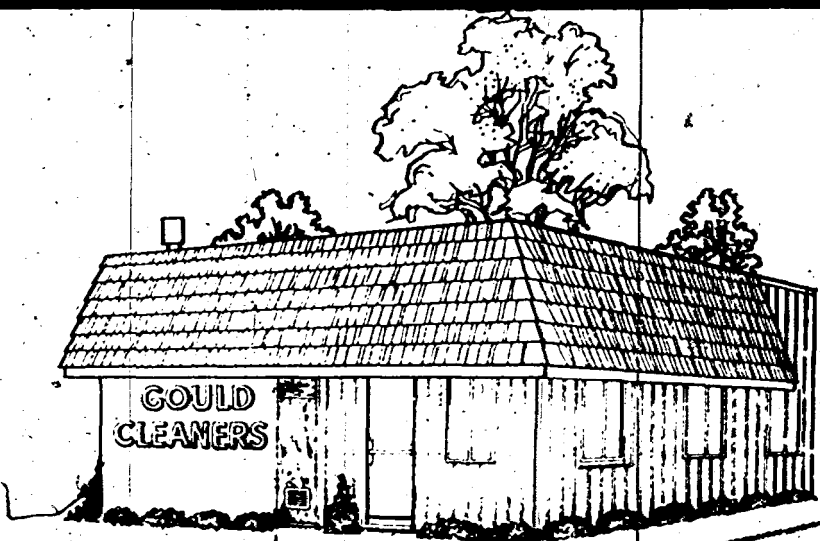

*Wedding Dresses Deserve Special Care in Cleaning
The Details
are in Irene & John's Expertise.*

GOULD CLEANERS

212 S. Main
453-4343

6 DAYS A WEEK
6:30 a.m.-6:30 p.m.

WE OWN AND OPERATE OUR OWN PLANT
5 1/2 DAYS A WEEK—MINOR REPAIRS FREE

**3 HOUR SERVICE
PICK UP AND DELIVERY**

Quality Cleaning & Service Our First Consideration

Annual
**STOREWIDE
Inventory
Clearance**

sale

Laurel

FURNITURE
584 ANN ARBOR TRAIL, PLYMOUTH
Last three days

**EVERYTHING IN
STOCK ON SALE!!!**

END OF YEAR CLEARANCE

Super Savings on Sealy!



For \$399⁰⁰
You get a lot
of Clock



SOLID PINE
SWIVEL
BAR STOOL
TWO FINISHES
24" and 30" High
\$39⁰⁰



Amazing Savings on
Antique Brass
Finished Lamps
\$29⁰⁰



**SEALY
BEDDING**

STARTING AT
\$59.88 each piece
TWIN SIZE

**TREMENDOUS
SAVINGS ON
ALL
Sealy
Bedding . . .**

Living Room-Bedroom-Tables-Lamps
Dining Room • Juvenile Furniture
Desks
plus more

Sale now in progress

Immediate Delivery on all Purchases

No Layaways
Thursday, Friday til 9 pm
Open Daily 9:30-6 pm
Saturday til 5:30

Plymouth 453-4700

quantity limited on all Sale items.

Try the best SEALY POSTUREPEDICS[®]
in 100 years - It's a great time to buy!
America's No. 1 selling mattress is made for good
sleeping... no morning backache from sleeping on
a two-foot mattress. Only provides a night for the best!

Come in, today! Available for immediate delivery.
All Sales Final

Choose a photographer with care

BY ROBERT CAMERON
(Crier photo editor)

Your wedding day is over fast, but the photos of the big event should last a lifetime. That is why it's so important to take special care choosing a wedding photographer.

Here are a few tips:

First, the general rule, "You get what you pay for," holds true in wedding photography. Don't run out and choose a super-cut rate one-time-only special from a fly-by-night photo studio. And don't let your uncle, who assures you he knows everything about photography, but probably couldn't tell a lens from a lightmeter, shoot your wedding.

Shop around for a reputable professional. He or she may have slightly higher prices, but it will be worth it in the long run. If dealing with a large studio ask to speak directly with the photographer who will shoot your wedding. Beware of studios that show samples of work done by someone other than the photographer you've selected.

Second, book your photographer well in advance. If your wedding is in the busy months, June through September, one year in advance isn't too early.

Third, match your tastes with your photographer's style. If you like the traditional posed shots, choose a photographer who excels in this area. If, on the other hand, you like more creative or unusual photos, or you want to be sure to capture the spirit of the reception, select a photographer who can show you with his book of proofs that he or she can do these things.

Fourth, reserve some time. A photographer has to capture all the moods of your wedding, and she or he can't do that without your help. Tell the photographer who the special relatives are, for example, and any particular scenes or people you want captured. Don't let Aunt Tilley or Uncle Harry interfere with professional work by telling the photographer how to take pictures.



Finally be patient after the wedding. Your photographer will need time to complete the proofs and the album. The proofs may take three weeks to complete, with the final album taking up to eight weeks to complete.

All in all common sense should be your guide.



The day is forever

*The look is
You!*

Coiffeurs By Joseph

Professional Cutting & Styling
Men & Women
7 operators to serve you

880 Fralich
Plymouth
453-2343
Open Evenings

P.S. Hair Designs for the Groom, too!

Tradition exists with individuality

BY DAN BODENE

Although the news isn't startling that traditional weddings remain the most popular types for young couples, there are a few unique twists in the theme this year.

New developments are being cited in apparel, decorations and even food.

Becky Vodden of Geneva's of Plymouth says although the traditional look in bridal gowns is still the best-seller, "Brides are willing to do different things more than ever." The willingness to experiment with innovation comes in part from what a wedding gown means to a woman, Vodden explains.

"A wedding dress is a very emotional thing," she says. (A bottle of lavender smelling salts on the upstairs desk is an obvious testament.) "It shows how the bride feels about the wedding." Choosing the gown is therefore a very touchy business, and bridal salon employes are acutely aware of the emotional aspect of the choice. In fact, emotion plays an all-important part in the process.

"You can usually pick up on a personality from a bride," says Vodden. "By seeing what they lean toward and what they pull away from. It's a very individual thing."

All but about one per cent of prospective brides who visit a salon already know what basic type of gown they will choose, but it is the specifics that give each dress its individuality and open the way for innovation, Vodden says. "They usually have an idea already," she explains. "The entire wedding, in most cases, has already taken form in their minds. Most brides have already been through all the magazines and already have a set of likes and dislikes. It is the specifics such as neckline, skirt and headpiece that they want to do different things with."

Most brides are leaning toward a romantic feeling, especially the "Lady Di" look" complete with expensive fabric, long train and beadwork.



"They are interested in a lighter, delicate, feminine look," says Vodden. "Likewise with bridesmaids."

Many of the details which make a traditional-style gown so individual are in fact based on ideas popular long ago. Now in style (as was also the case in bygone eras) are dashes of color to accent the white dress, such as a lavender sash, blue bow or pink underlining. Gown lengths are also the

Cont. on pg. 21



Wedding Belles

We also carry a complete line of paper products, tablecloths, napkins, banquet rolls, plates, etc. EVERY COLOR IMAGINABLE.

All the things you need for a beautiful wedding party can be rented from us.
Chairs, tables, table settings, even a spectacular champagne fountain. Custom decorations if you like. All at modest rates. Delivery service also available. We provide everything for the party but the groom.
For this special event, call a specialist -- the rental people people.

UNITED RENT-ALL



Call: 455-2100
510 Ann Arbor Rd.
Plymouth



Getting Ready For A Special Day

Mel's Golden Razor

Specializing In

- All Long Haircuts
- Unisex
- Styling & Shags
- Children's Haircuts
- Regular Haircuts

595 Forest
appointments honored
walk ins welcome

Hours 8:30 a.m. to 6 p.m.
Saturday to 4 p.m.
Closed Monday

455-9057

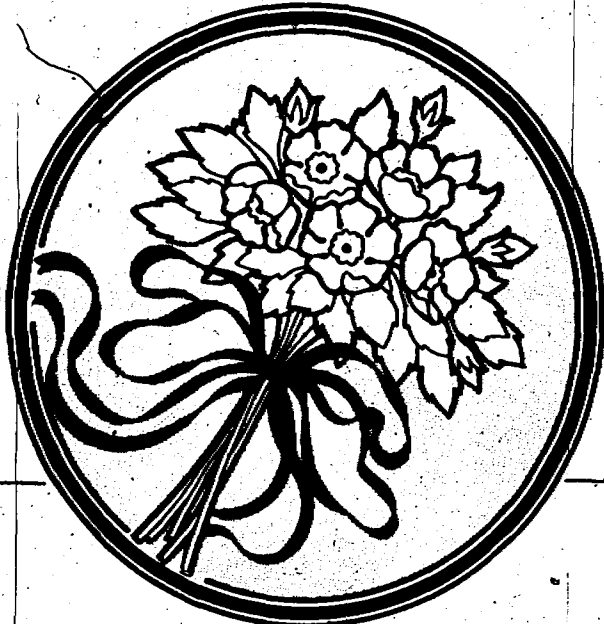

For that special moment
in your life, only
the best will do . . .

**heide's
flowers & gifts**

Ann Arbor Trail at Harvey, Downtown Plymouth

453-5140

Beautiful Silk or Fresh Wedding Flowers

And don't forget flowers or cake

Cont. from pg. 20

subject of individual choice. New for this year but nonetheless very formal is the tea-length gown, which falls to the ankle.

A headpiece is perhaps the one accessory that takes as much time to choose as the dress itself, Vodden confides. "Most big designers coordinate the headpiece, but some houses do them separately. At least half of the brides don't go with the headpiece that comes with the gown -- it's sometimes easier to get them in the right gown than in the right headpiece."

Second weddings are a slightly different situation for the prospective bride, Vodden says, mainly because sometimes "The first wedding was run by mom, but the second is hers. She gets just what she wants." And although some people might conjure visions of firm social guidelines on the type of gown worn for a second wedding, they just don't exist, Vodden assures. "There are no rules anymore. She's going as a first bride if that's what she wants. Sometimes second weddings are even bigger."

For second or third weddings, Vodden says all dress lengths are popular, from cocktail short to full train long. Hats are also usually chosen.

For all wedding dresses, timing is obviously a prime consideration. Favorite wedding months are from April to June, Vodden says, and from August to October. Although July is the slowest month of the summer, April and May weddings are picking up due to the plethora of June weddings and the added complications of prom dates. Lighter fabrics are chosen for the climate in these usually balmy months, and styles incorporating sleeveless designs. For weddings in "winter-winter" during January and February, heavier fabrics such as satins are preferred.

Timing is also a factor in completing the gown. Since all at Geneva's salon are special ordered, Vodden says a minimum of from three to five months are needed, with six months as an optimum time. "Gowns in our store are used for basic fitting and are not sold," Vodden adds. "The better gowns must be specifically cut, because each bride has

a different shape. Special orders must be sent away, mostly to houses in New York, Pennsylvania and California. Headpieces are done mostly in Chicago, Illinois and in New York."

Fitting a gown is no one-step process, either. Vodden explains each bride begins by choosing the basic design, often among four or five candidates narrowed down by process of elimination. A basic design of gown is sometimes not even decided on the first visit, Vodden says -- other area salons are also investigated. When the final choice is made (often with help from mom or a bridesmaid), a comprehensive and careful set of measurements is taken and the gown ordered.

After it arrives from the design house, the first fitting is taken to tailor the dress for underthings and shoes. What goes under a wedding dress has a great effect on the overall fit, Vodden says, especially since heavy slips are popular now.

Several more fittings may be needed before the final one. At the last fitting, the bustle is planned, and buttons on the waist of the dress and loops on the train are calculated so the train can be fastened to the gown after the formal ceremony. Brides aren't interested in holding the train over their wrists anymore, says Vodden, because of the wear and tear. After the final fitting, the dress can be picked up prior to the ceremony.

And all is accomplished with the expert consultation of the salon. "You really can't call the employes 'salespeople,'" Vodden explains. "There's more involved. It goes beyond sales. People such as the brides, friends and family come in over six months and they become friends." And frequently co-workers, as Vodden can attest. Formerly working in computers, she came to Geneva's for her own second gown and after the wedding came to work at the salon, as have several other employes.

"It's a lot of hard work," she says, "but we all love it."

There are other labors of love in planning a wedding. One is decoration, and more and more ceremonies are now bedecked with

Cont. on pg. 22

Emily's
World

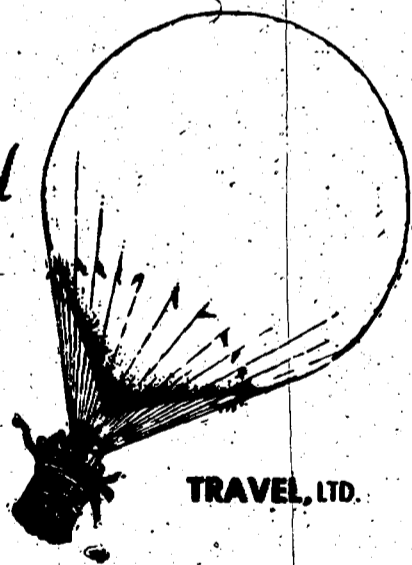

TRAVEL, LTD.

•Continuing 25 years of personalized service to residents of this area.
708 S. Main • Plymouth
•Opposite Farmer Jack•

MONDAY-FRIDAY 9 to 5:30
Phone 455-5744

... FOR THE FUN OF IT!

Winter White SAIL



Snow and cold weather getting you down? Well, that's nothing! Wait 'till you see what's AHEAD.

Get the drift? Sure you do. Trouble is, you'll get it NEXT month, too.

Why not leave it all behind, for a while. Take it from us . . . we've been there . . . a care-free CRUISE will end those Winter "Drears". Relax and unwind in the warm Caribbean sun. Enjoy a variety of fun activities . . . or just do nothing! Take it at your own pace. New places, new faces, tantalizing cuisine . . . they're yours for the asking. NOW. At surprisingly affordable prices for every budget, too.

This could be the adventure of a lifetime . . . the one you've always dreamed of! We're CRUISE SPECIALISTS. Call us today, and we'll help plan the best vacation you ever had.

Then start packing . . . with a SMILE!



EMILY GUETTLER, MGR.

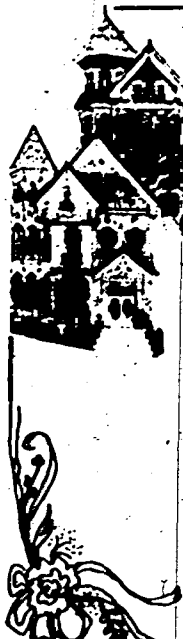

Brides

Help your friends and relatives by using "Wayside" for your Bridal Registry.

We will be happy to assist you in selecting items for your new life—bath accessories, wall decor, candle sticks, table linens, stemware, stainless, Johnson Brothers ironstone and a complete line of Pfaltzgraff stoneware.

Wayside • Pick O' the Wick

800-520 W. Ann Arbor Trail
Plymouth, Michigan
Phone 463-5310

Hours
M-Th 10-6
F-10:00 Sat. 10-6

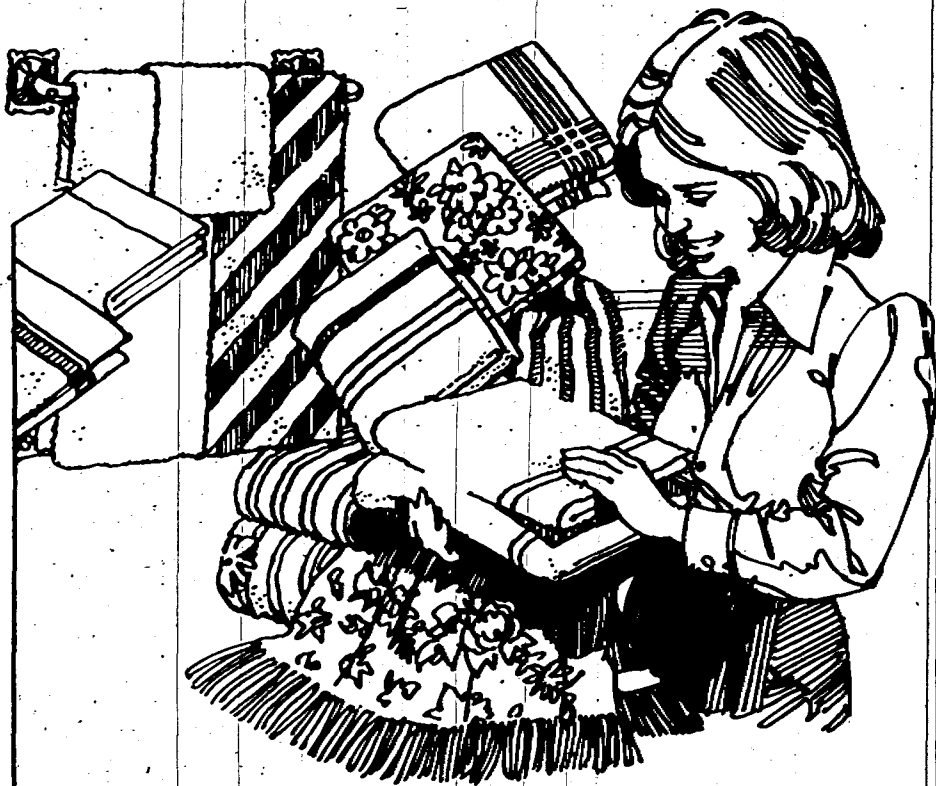

Create Your Own Beautiful Bath

Towels
Shower Curtains
Rugs & Carpeting
Bath Scales

Hampers
Decorative Seats
Decorative Accessories
Colorful Soaps
and Bath Things

Vanity Cabinets
Fancy Faucets
Medicine Cabinets
Mirrors

One of the largest and most complete bath shops in the state
Bridal Registry



190 E. Main, Northville
349-0373

Mon.-Thur. 9-5:30
Fri. 9-9
Sat. 9-5



Choosing wedding gown is not easy

Cont. from pg. 21

keepsakes that can literally last forever.

Karen LeGault of LeGault's of Plymouth Bridal Flowers says tradition with a new twist is what makes her shop increasingly more popular with couples. "My goal is to give a girl the prettiest wedding she can have for the price and quality she wants." To that end, the tradition of flowers can be fulfilled with a new twist — blossoms of silk.

The advantages of such a variation are many, LeGault explains. Silk flowers are non-allergenic, cheaper and last longer than natural flowers. "The New York Times predicts that silk flowers will outdo fresh ones at weddings two to one," LeGault says. "This is one business that the recession has actually helped — you can see the value of your dollar over and over again."

When choosing silk flowers for a wedding, a dress sample is needed and budget considerations are discussed. LeGault explains that since a hallmark of her shop is personal attention, she hesitates to quote prices over the phone. "In our shop, the bride can select exactly what she wants. Every wedding is a custom one, so we spend a lot of time with every customer."

An added bonus with planning a floral arrangement with silk flowers, LeGault says, is that naturally out-of-season blooms are always available in silk. The possible problems with arranging and transporting live plants to a wedding are also unheard-of with silk arrangements because little care is needed in storing them indefinitely — which is another important point to brides.

One of the prettiest and most popular styles available is the lantern wedding, LeGault says. Both the lantern centerpiece and flowers around it can be kept by guests. And brides very rarely throw their silk bouquets, but have special "tosses" made. Even the style of bouquet is changing due to the advantages of silk arrangements, LeGault reports. Instead of the small nosegay usually popular in a live floral bouquet, brides now often walk down the aisle with a whole armful of silk flowers. A large bouquet with a "Lady Di" design influence is now very popular at LeGault's shop.

With ribbon and arrangement possibilities literally up to the whim of the bride, what more could add to the impact of flowers? Placing some on the wedding cake, that's what's more.

After trips to the bridal salon and flower shop, the next stop is often at the cake baker. Working closely with LeGault's Genny Towfley of Create-A-Cake in Canton.

"Sometimes people don't look at the total wedding," she says. "Brides will go to a lot of trouble to choose a gown, but end up with a cake that doesn't fit their needs. We let people design their own cake, because it's a personal thing, too. And nobody has money to waste. People are looking for value, and they deserve to get what they pay for."

Create-A-Cake's chefs can do just that, she says, once an idea of how many people will be attending the ceremony and what the projected budget for a cake will be. Many factors help decide the actual construction and style of the cake — for weddings with 150 guests, for example, a small three tier cake might be sufficient. But a cake built up from a styrofoam base can look as large as if it was ordered for 900 people, and still be a value at the price. Other decorative aspects of the cake can be custom-designed, such as floral details coordinated with LeGault's.

Just as in all phases of planning the wedding, lead time must be given to the baker. Create-A-Cake maestros suggest ordering the cake up to two months before the wedding, although nearly all details can be changed up to the last minute. Since the cake is baked the day before the reception, however, a set date is all-important.

As explained above, many of the weddings popular with couples today are based on a traditional theme. Each, though, is more than just a copy of a set format, and the range of personal expression is up to the imagination. Traditional themes will always be favored, and the innovations couples are willing to introduce are proof of that imagination.

Wedding Planner

6 MONTHS

- ✓ Decide budget for wedding.
- ✓ Make arrangements for wedding and reception sites.
- ✓ Decide how many guests can be accommodated.
- ✓ Plan reception menu with caterer.
- ✓ Begin guest lists.
- ✓ Plan for bridal gown and attendant's dresses.
- ✓ Register and select china, crystal, etc.
- ✓ Contact photographer.

3 MONTHS

- ✓ Complete guest list.
- ✓ Decide music for service and reception.
- ✓ Consult with florist.
- ✓ Order wedding cake.
- ✓ Select tuxedos.
- ✓ Order invitations and announcements.
- ✓ Plan honeymoon; make reservations.
- ✓ Decide on future home.

2 MONTHS

- ✓ Select gifts for attendants.
- ✓ Buy wedding gifts.
- ✓ Buy wedding rings.
- ✓ Mail invitations.
- ✓ Arrange lodging for out-of-town guests.

1 MONTH

- ✓ Make hair salon appointments.
- ✓ Arrange for final dress fitting appointments.
- ✓ Plan rehearsal, bridesmaid's luncheons.
- ✓ Arrange for newspaper announcements.
- ✓ Go for marriage license.

2 WEEKS

- ✓ Send announcements to newspapers.
- ✓ Arrange for transportation to church.
- ✓ Finalize florist, catering, wedding and reception arrangements.
- ✓ Arrange rehearsal.
- ✓ Check honeymoon reservations.

1 WEEK

- ✓ Begin honeymoon packing.
- ✓ Give final estimates to caterer, reception hall.
- ✓ Check on final details with photographer, musicians, wedding cake shop, etc.
- ✓ Hold rehearsal, luncheons.
- ✓ Try not to be nervous.

Our Bridal Couple has selected rings especially designed for them.



*O. & D.
Bush
Jewelers*

Member
Diamonds for Investment
Ltd.

481 Ann Arbor Trail
455-3030

Designers of
Fine Jewelry
Established
in 1944

For that one unforgettable moment -- you stand together, poised in time . . .

We can personalize your wedding flowers whether they be fresh or silk bouquets. Make your appointment now.

Full Service Florist

Our Prices will surprise you. Please come in and look over our bridal albums of beautiful bouquets we have available.

SPARR'S

Flower Shop
&
Greenhouse



We deliver to the entire
Metro Detroit Area.

42510 JOY RD.
Plymouth
453-4268



Order Confidently through
your Wedding Specialist . . .

- ★ Invitations
- ★ Announcements
- ★ Reception Cards
and Accessories



Pilgrim Printer

632 S. Main, Plymouth
453-6770



- Heating
- Air Conditioning
- Plumbing
- Sewer Cleaning

24 Hour emergency service

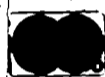

Puckett Company

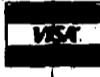

412 Starkweather (in Old Village) 453-0400

FIRST APARTMENT, FIRST HOME, FIRST STOP . . .
HIDDEN TREASURES



LET US BE YOUR BUDGET STRETCHER

- Dishes ● Cookwear ● Furniture ● Linens ● Pictures
- Mirrors ● Lamps

Everything you need for that first home

TELL US WHAT YOU NEED . . .

WE'LL LOOK FOR IT

WE HAVE A CALL LIST AND 30 DAY LAY-AWAY



HIDDEN TREASURES

RESALE SHOP
728 S. Main St.
Plymouth
459-9222



PLYMOUTH MERCHANTS who pitched in to give the couple a wedding (and honeymoon) to remember include, from left, Don Bush of O and D Bush Jewelers; Carole Elker of the Plymouth Hilton; Dolly Ettenhofer of Beautiful People Hair Forum; Kathy Kellogg, the bride-to-be; Jeff Faigle, the prospective groom; Geneva Salyer of Geneva's of Plymouth; and Rex Tubbs of The Engraving Connection. (Photo courtesy of James Rawlinson)

Medical Society encourages extra premarital tests

If you're in the doctor's office for a premarital examination, don't be surprised if the physician asks to take one or two additional precautionary tests.

The Michigan State Medical Society is encouraging its member physicians to screen premarital exam patients for sickle cell trait and/or rubella. While the tests are not mandatory, the information gained may be very important to couples wishing to bear children.

The rubella test will determine whether the measles a woman may have had as a child were rubella. Females who are not protected from rubella should be immunized as a precaution in the event they become pregnant. A simple immunization may spare a child from deafness and other physical disabilities that may occur when pregnant women are exposed to rubella.

Doctors note the tests can be conducted with blood samples drawn at the same time as the state-required sample needed to obtain a marriage license.

Premarital screening can be an important precaution in insuring the health of children before they are born, the Michigan State Medical Society emphasizes.

Bed 'n Stead

For everything the new bride
wants and needs

Sheets, pillows, accessories for the bedroom, towels and soaps for the bath. A complete line for the kitchen and dining room, including placemats, tablecloths and napkins.

Use our Bridal Registry

470 Forest
Plymouth

455-7380

WINTER CLEAN UP!

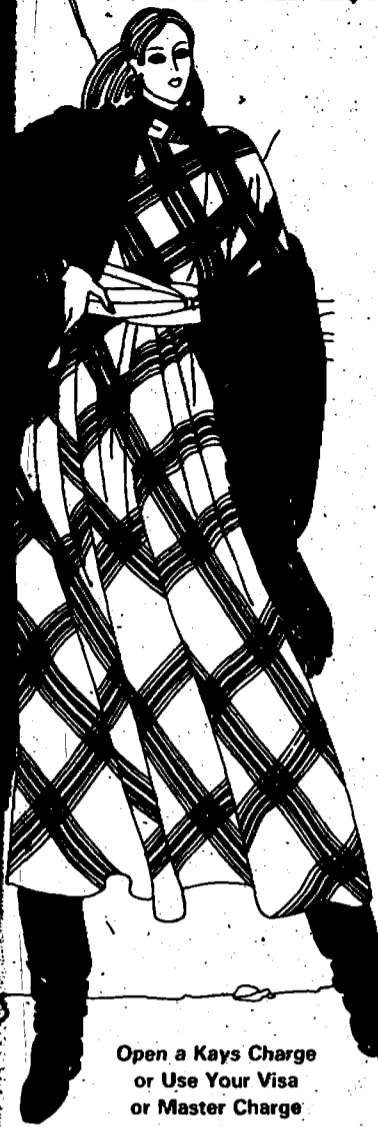

30-70% off winter merchandise

- Coats
- Dresses
- Lingerie

Choice Merchandise

New Spring Merchandise
arriving daily

\$4.99
Special Group
Tops-Bottoms
Dresses

Kay's

of Plymouth

Open a Kays Charge
or Use Your Visa
or Master Charge

Mon.-Thurs 10-5:30
Fri. til 9 pm Sat 10-5:30

846 W. Ann Arbor Trail
453-7855



The expression of quiet distinction
in designer lingerie fashions
and accessories.

Schante



Accent your honeymoon with lounge wear,
cruise wear, and day wear.

Spring Fashions now appearing!

Now serving you in two locations.

No. 7 Forest Place
Plymouth, MI
455-4100

Great Oaks Mall
1288 Walton Ave.
Rochester, MI
652-3620

45th ANNUAL WINTER SALE



20% to 50% Savings on truly fine furniture by many famous makers. Lamps, Carpeting, Accessories, Wallpaper and one of Michigan's largest selection of Grandfather clocks **ALL ON SALE** through March 6th. Take advantage of our highly qualified Interior Designers to aid you with your decorating needs.

Design Society
of
America

Member



Colonial House

Since 1937
20292 MIDDLEBELT ROAD, LIVONIA (South of Eight Mile)
474-6900
MASTER CARD AND VISA ACCEPTED

Open Sundays in February 1:00-5:00

Mon., Thurs., Fri. til 9:00



Eugene VanZandt displays one of his special wedding cakes at the Cake World, in the Pinetree Plaza, 39477 Joy Road, Canton (1/2 mile E of Haggerty Road). VanZandt urges Brides-To-Be to order their wedding and shower cakes early to receive a **15% DISCOUNT**. Free in-store samples available for tasting. Bring in ad by February 28th to receive your **15% OFF!** Orders may be placed by phone at 453-7990.

For the Contemporary Bride & Groom
With That Personal Touch

Sideways has more than a bridal registry. I call it a wedding registry—the store will be yours for the evening—you will be able to browse & select together china—stemware—etc. for your new home. Call for an evening appointment with me to help you coordinate your wants and needs with your life style. It will be lots of fun, too—
Sharon

sideways
 —FOR THE CONTEMPORARY HOME—
 505 FOREST
 PLYMOUTH, MI.
 453-8312

340

Food & Spirits

Plymouth Landing

The Elegance of the Rehearsal dinner reflects on the family of the groom. Careful planning on our part will insure those Special touches -- for a memorable start to a wonderful occasion . . .

304 N. Main
 455-3700

The focus of attention
 our breath taking wedding cakes . . .
 delicious as well as beautiful.

12 Westchester Square
 550 Forest 453-7788



Invitations
by Susan

Make choosing your wedding invitations, a relaxed enjoyable experience, with the undivided attention this decision deserves!
 Up to 3 companies to choose from & 10% off your whole order by mentioning this ad.

(In Home Service)
 By appointment only
 455-5878

Reduce Fuel Costs
 with
Wood Burning Stoves.
Sensibly Solid . . .
Solidly Sensible

"Come in and see the Blue Ridge in operation"

Old Billage Woodstove Shop



459-3135
 744 STARKWEATHER
 PLYMOUTH, MI 48170

Father of the bride

The forgotten man

BY DICK BROWN

There are many experts in the wedding field—some with fashion credentials, others to handle such chores as taking the official wedding pictures, feeding the guests, travel experts to arrange the honeymoon trip, professional decorators and the always present florists.

There is one field, though, which doesn't get as much glory, or at least the glory deserved for the dollars spent and the agony and ecstasy brought on by the nuptial ceremony.

So, I hereby declare myself the expert in the art of being father of the bride.

For credentials, I submit having been involved in marrying off three daughters and three sons with a son and a daughter yet to make the big step.

From that experience, the first suggestion which won't go over very well with the rest of the family, is to suggest a trip to city hall. Once the father of the bride is shouted down on this suggestion, the next suggestion offered to the father of the bride is to get a second job, keep further opinions to yourself during the planning stages of the big wedding and stay out of the way.

Being the father of the bride is a lonesome feeling.

There are long and involved discussions on picking the date, determining the size of the wedding and fitting the church to the crowd, contacting the minister, narrowing the field for bridesmaids and groom's attendants, selecting the bridal gown and the gowns for the bride's attendants, picking out the color (usually the gaudiest one available) for the males in the wedding party, contacting the florist and arranging for the wedding cake.

Then there is the selection of the invitations and the agony of coming up with the guest list, making sure that second cousin, Jennie, survives at least the first cut.

Another big chore is the selecting of the tableware pattern, picking out the china and going through all the catalogs to pick out the pots, pans, casserole dishes and small appliances which generally stay on the shelves in this age of TV dinners and convenience food.

There's also discussion on where to have the reception, picking the caterer, selecting the church soloist and arranging for the honeymoon trip.

Through all this wedding talk, the advice to the father of the bride is to try to act interested, keep the mouth shut unless directly spoken to and get engrossed in the newspaper or find something on TV to while away the time.

Responsibility of the father of the bride when the big day finally arrives, is to get into the formal attire without expecting any help, because everyone in the family will be concentrating on the bride-elect, make sure you have your lines down pat for giving away the bride, hope that you can walk your daughter down the aisle without stepping on the bridal dress train, remember where you are supposed to stand and eventually sit and where your spot is in the reception line.

In the meantime, try to plagiarize a clever toast to use at the reception, greet and mix with the guests, many of whom you have never seen before and probably won't see again until the next family wedding and try not to think of the big wedding bills which will wreck the family budget for the next 12 months.

Being the father of the bride is a great experience. No father should miss the opportunity. It's just like hitting yourself in the head with a hammer—when it's all over you feel good.

And when it is all over with and you struggle out of your rented formal attire, crawl into bed and contemplate the big day, offer up a prayer that in the next life all your daughters will elope.



Legal steps you need to make before your wedding

Compared with everything that duly follows, the legal steps a couple must take to get married in the State of Michigan are easy.

Marriage ceremonies, be they before a judge or mayor or in a church, are taxing times for both families, as are all the necessary arrangements that need to be made to make it the kind of wedding event a couple wants.

Two legal steps that must accompany other preparations are taking a blood test and obtaining a marriage license. There are a few other legal matters to tend to, such as necessary witnesses, but in general that is all the couple needs to produce to go ahead with the ceremony.

The legal age for marriage in this state is 18 for a male and 16 (with consent of the parents) for a female.

Once the couple has set the date for the wedding, they then must visit their physicians, or any area medical clinic and have blood tests prepared.

The blood test can be taken no earlier than 30 days prior to the wedding. So if the wedding date was set for March 10, the tests could be taken from Feb. 8 on, for example.

Bloods tests are needed to check both the bride and the groom for communicable venereal diseases and to have the blood types on record for future use, such as with the birth of a child.

After the blood test results are obtained, one of the couple must go to the Wayne County Building and its Marriage Licensing Bureau. The building is located at 201 Woodward, in downtown Detroit. To be married in Wayne County, at least one of the couple must be a county resident.

If the results of the blood test prove negative for either the bride or groom, the only way to obtain a marriage license is if a doctor certifies on paper that the disease is arrested or non-communicable.

According to County Deputy Clerk Bob Ruggeroli, the person must pass a standardized health test to ensure the disease is in a non-communicable state.

He adds that the licensing bureau is just another one of the County Clerk's functions.

Marriage licenses are \$20 and must also be obtained 33 days prior to the actual wedding date.

Blood test results plus identification, such as birth certificates, are taken to the bureau and processed. That takes approximately five days, and then your marriage license is ready to be picked up. All that remains are the bigger hassles and worries and the greater joys.

The license itself reads, "This marriage must take place within 33 days of the application."

The couple's names, ages, birthplaces, dates of birth, addresses, occupations, number of times previously married, father's names and mother's names are also on the certificate.

Underneath is a space where the County Clerk or Deputy Clerk sign the certificate. At the bottom are both party's names, where they were married, the county, date of marriage and the signatures of the best man and maid of honor.

If you are to be married by a local magistrate, judge or mayor two witnesses are needed.

After the ceremony the license is given to the officiating person for signature. One copy goes to the state, one copy to the County Clerk's office, and one to the couple.

Lucky is the Bride...

whose friends remember to get her books for shower & wedding gifts...

Books on Travel
(for honeymoon ideas)
Cook Books
(for delicious meals)
Memory Books
And lots of good books to begin a permanent Home Library

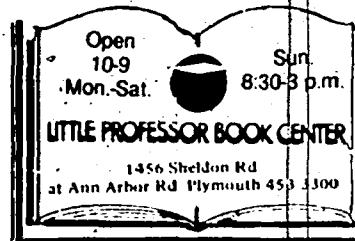

on Your Special Day You deserve the Finest . . .



The Plymouth Hilton Traditionally Offers . . .

. . . the warmth, hospitality and individual attention each occasion has the right to expect. Our bridal parties are so carefully arranged that the day creates wonderful memories for all . . . the Bride, Groom, family and friends, can be comfortably accommodated for their stay in our beautiful hotel.

At the Plymouth Hilton you may always depend on expert guidance from Cathy O'Meara our Catering Director and our professional banquet representatives. For your prime date please call . . .

PLYMOUTH
HILTON
INN



Northville Rd at 5 Mile
Plymouth, Mich. 48170
(313) 459-4500

Today Tomorrow and always

Be in great shape on Your Special Day . . .
Avail yourself of our fine services.

- Designed Hair Care
- Body Wrapping
- Complete Skin Care
- Total Nail Care
- Body Tanning

MAYFLOWER SALON

470 Forest Place
453-8320

Men/Women/Children
A total look for the individual
Mon./Tues. 8:00-7:00
Wed./Thurs./Fri. 8:00-8:00
Sat. 8:00-5:00



Great
Shape

630 Starkweather
Plymouth MI 48170

453-5254





LAST CHANCE TO ENTER

Announcing the Crier's

Today's Gourmet Cookbook Contest

Grand Prize \$60 Certificate good at participating businesses

Finalist Prize \$20 ONE PER CATEGORY

OTHER COOKING PRIZES AWARDED

**Cook Off
Feb. 13, 1982**

Deadline Noon Fri. Feb. 5, 1982

**ENTER
NOW!**

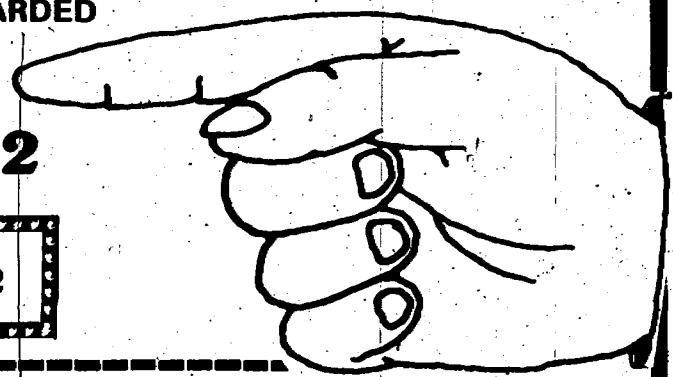

1982 Crier "Today's Gourmet" Cookbook Contest

- CATEGORY:**
- Kids in the Kitchen (16 & Under)
 - Main Dish
 - Soup
 - Dessert

ONLY ONE ENTRY PER CATEGORY (You may, however enter more than one category).

Note You need not enter an entire meal for your chosen category. Any single portion of the meal will do.

Name of Dish _____

Your Name _____

Address _____

Phone _____

Rules

- ★ You may submit one recipe in each of the four categories.
- ★ All recipes must be typed or neatly printed on 8 1/2 by 11 paper. Attach a separate entry blank to each entry.
- ★ Recipes must be received by noon, Fri. Feb. 5. Don't rely on the mail to deliver your last-minute entry on time.
- ★ Judges will select category Semi-finalists based on the initial recipes. Semi-finalists will be asked to participate in a cook-off on Saturday, Feb. 13. Winners will be selected on the basis of those entries and announced in the Feb. 17 edition of The Community Crier.
- ★ Professional cooks and bakers, families of The Crier staffers and judges are prohibited.
- ★ All entries become property of The Crier with your credit in the 1982 Today's Gourmet section.

Entry Deadline Noon, Feb. 5, 1982

PLYMOUTH-CANTON

Professional Service DIRECTORY



ALLERGIST

DAVID H. SEAMAN, M.D.
MARTIN E. HURWITZ, M.D.
 Pediatric and Adult Allergy

Office Hours By Appointment 8578 Canton Center Rd. Canton, Michigan 48187 Phone: 453-8410

ATTORNEY

- No Fee For Initial Consultation
- Auto Accident (No Fault) •Job Injury
- Hospital Negligence and Malpractice
- Injury from Defective Products •Social Security Federal Injury •General Practice •Criminal

John F. Vos III 455-4250
 over 40 Lawyers Associated with Firm 509 S. Main Plymouth

FAMILY PRACTICE

PLYMOUTH COMMUNITY CLINIC
 1311 Ann Arbor Rd.
 Family & Diagnostic Medicine
Wm. M. Ross D.O. P.C.
 453-8510
 Podiatrist & Podiatry Surgery
Harry Oknalan D.P.M.
Aram Mechigian, D.P.M. P.C.
 453-6090

DENTIST

FAMILY DENTISTRY
 douglas a. read, d.d.s.
 frank e. pink, d.d.s.

Hours by appointment saturday & evening available 3300 n. lilley canton, mi 48187 397-8282

DERMATOLOGIST

ARTHUR W. GULICK, M.D.
 Diplomate, American Board of Dermatology
 Diseases of the Skin

Saturday and Evening Appointments Available 227 N. Sheldon Rd. Plymouth, Michigan Phone: 459-3930

Plymouth Professional Park 509 S. Main Plymouth, Michigan

FAMILY DENTISTRY

GARY E. HALL, D.D.S.
JOHN L. HENDRICKSON, D.D.S.
DAVID A. TeGROTEHUIS, D.D.S.
DEAN B. SOMMERFIELD, D.D.S.

42901 Schoolcraft (313) 420-2326

Office Hours by Appointment
 Mon., Wed., Thurs., 8:00-6:00 pm
 Tues., 1:00-8:00 pm Fri., 8:00-5:00 pm
 Sat., 8:00-1:00 pm

FAMILY PRACTICE

FAMILY PHYSICIAN
Evans John Farres, D.O.

Harvard Square Shopping Center 6050 Sheldon Rd. Canton Twp., Michigan 48187 Daily Office Hours & Saturday 459-5500

FAMILY PRACTICE

M. Garber, M.D. Pediatrics
I. Miller, M.D. Pediatrics
L. Hochman, M.D. OB Gyn
S. Migdal, M.D. OB Gyn
R. Minkin, M.D. Internal Med.
D. Panush, M.D. Internal Med.

Phone 459-7600 Address 8564 Canton Center Canton Professional Park Canton

O.B. GYN

CHARLES T. CASH, JR., M.D.
 Obstetrics - Gynecology

Oakwood Hospital 459-7030
 Canton Center
 7300 Canton Center Road
 Canton, Michigan 48187

PODIATRIST-FOOT SPECIALIST

RICHARD HELIGMAN, D.P.M.
 Member American College of Sports Medicine
 Medical and Surgical Foot Specialist

Pediatrics, Orthopedics, Sports Medicine and Diabetic Care related to the Foot 851 South Main Bentley Clinic Plymouth, MI. Phone: 455-3689

PODIATRIST

BARRY H. GALISON, D.P.M., P.C.
JOHN SCHILERO, D.P.M.
 Medical & Surgical Foot Specialist

Member American Academy of Podiatric Sports Medicine 45156 Ford Rd. Canton, MI. 48187 Phone: 459-2770

SURGEON

Daily Hours By Appointment Sat. 1:00-3:00 p.m.

J.M. McNAMARA, M.D., P.G.
 General Surgery and Family Practice

Phone: 453-0320 9430 South Main St. Plymouth, MI. 48170
 3 doors South of Ann Arbor Rd.

Getting the Best of Anything . . .

**. . . Means Knowing
Where to Find It**



Brides Showcase
ALBION SHOPPING CENTER

**US-23 at Washtenaw
Ann Arbor**

971-6455

**Open: 10 a.m. to 9 p.m.
Monday thru Saturday**

All-Star concert has Jan. 29 date at Salem auditorium

An All-Stars Concert is being planned for The Plymouth-Canton Community, says local musician-entrepreneur Dicky Lee.

The Jan. 29 concert, which features Centennial Education Park Battle of the Bands winners Apocolypse and Warrior along with Dicky Lee and Friends, will begin at 7:30 p.m. at the Salem High auditorium.

The concert has a dual purpose - to help generate interest in local musicians and also aid CEP electronics students. Some of the proceeds of the concert will go to benefit the CEP electronics classes, Lee explains.

Tickets cost \$2.50 regular admission, \$2 for senior citizens and students, and are available at Arnholdt Williams Music and at CEP.

Gallimore PTO is taking orders for I.D. jewelry

Gallimore PTO is offering non-tarnishing stainless steel identification bracelets and neckchains for sale as a public service and fundraiser.

Priced at \$2.50 each, the tags can aid in identification and prompt notification of parents in case of accident or sickness.

Space allows for five lines of lettering with up to 21 characters per line.

A sample bracelet can be viewed at the school office. Orders can be placed through Feb. 5. Pet tags are also available.



Former editor weds

NEWLYWEDS James Payne Miller and Patricia Ann Bartold were married Dec. 19 at Holy Angels Church in Sturgis. The bride, daughter of Virgil and Marge Bartold, wore an eyelet material gown made by her sister, featuring an A-line skirt and accented with a string of pearls. She was attended by her sister, Maid of Honor Beth Kennen, and flower girl Jill Kennen. The groom, son of Dean and Lois Miller, was attended by Best Man Tom Miller. The couple live in Oakland, Calif. The new Mrs. Miller was formerly Managing Editor of The Community Crier. (Crier photo by Sallie Roby)



Miller-Mooney vows said before judge in December rites

Gale I. Miller and Scott Mooney were wed Dec. 19 by Judge Dunbar Davis.

The bride, daughter of Mrs. Norine Miller and the late Anthony Miller of Canton, wore a gown with Queen Anne neckline trimmed in lace. She was attended by Matron of Honor Sharon Bush.

The groom, son of Mr. and Mrs. George Mooney of Westland, was attended by Best Man Rick Moran.

A reception was held at St. Simon and Jude Church hall in Westland.

The couple now resides in Westland.

Pre-school open house planned for C.E.P.

An open house for parents of Plymouth-Canton pre-schoolers will be held Wednesday, Feb. 3, detailing Centennial Education Park vocational child care programs.

Information at the open house will be available on vocational laboratory school for 3 and one-half to 4 year old children. Certified teachers Lois Santer and Sue Visser from Canton Children's Corner and Nancy McDowell and Betty DuBois from Salem's Small World will be in attendance.

The open house will be held in Canton High's Child Care Center, off Room 138, from 8 a.m. to 2 p.m.

School board recalls 7 laid-off teachers

Plymouth-Canton Schools administrators recalled seven laid off teachers and approved another's return from leave of absence Monday night, taking advantage of several position reductions.

Norm Kee, assistant superintendent for employee relations, explained nearly 12 positions were reduced before the second semester due to natural attrition, allowing other teachers to return to work. The reduced positions, Kee said, "Were positions, not necessarily individuals," adding with a smile, "The papers do have a problem with that sometimes."

All recalled teachers have been notified of their imminent return and have accepted contracts, Kee added.

Plymouth Symphony plans concert Feb. 7

Six members of the Plymouth Symphony, all of Ann Arbor and all with extensive backgrounds as performers, will be featured when the Symphony presents an "All Orchestra Gala" as its February concert in Salem High School Auditorium on Sunday, Feb. 7, at 4 p.m.

The program includes compositions by Franz Doppler, Wolfgang Amadeus Mozart, Franz Liszt and Peter Ilyitch Tchaikowsky. Johan van der Merwe of the University of Michigan Music Department is conductor.

The featured artists will be Glennis Stout and Allen Warner, flutists; Louis Stout, hornist; Kristy Meretta, oboist; John Mohler, clarinetist; and Jennifer Kelley, bassoonist.

Coffee and tea will be served by the Plymouth Symphony League during intermission and Girl Scouts will provide

free baby sitting at the auditorium for pre-school children.

Senior citizens will be picked up at Tonquish Creek Manor at 3:15 p.m. and will be returned by bus following the concert.

The concert is made possible by a grant from the state of Michigan through the Michigan Council of the Arts and the Plymouth Symphony League.

Symphony memberships can be obtained at Beitner Jewelry in Plymouth, Arnoldt Williams Music, Inc. of Canton, and Four Seasons Flowers in Northville. Single tickets are available at these locations and also at Plymouth Book World and Heide's Flowers, or at the box office the day of the concert.

Single concert tickets are \$5 for adults and \$2.50 for senior citizens and full-time students. Students 12th grade and under are admitted free.

City-Twp. police pact

Cont. from pg. 1

service to include road patrol, surveillance, investigatory services "designed to prevent the commission of crimes by both adults and juveniles," traffic enforcement, crime prevention programs, and court time.

Critics of the department say it's not doing the job as capably as the county did at one time.

Others, including Berry, staunchly defend the force's performance this past year. "These guys did one hell of a job. A lot of people complain because they don't see enough of them-- a lack of visibility. The force is taking a bad rap," he said.

Berry called it a strange year full of unpleasant surprises but solid performances. "We built good cases quickly against suspects in two homicides and handled the City Hall shooting without firing a shot," Berry said.

Berry added that population alone isn't in his philosophy in determining the future needs of the force. He believes a huge police force is not necessarily the answer to continued expanded service.

Berry admitted he is worried about the negotiations. "I have some disagreement with both Mr. Graper and Mr. Breen on the contract.

"Mr. Graper feels we need to get as much money to cover costs as possible, while Mr. Breen doesn't want to pay for

what he considers extra services," he said.

He added, "We have the Fall Festival in the city and the July 4th parade. Should the city completely pay for the cost of police service during those events when township residents are as much a part of them as the city?" Berry asked. "This should be a community project shared equally."

Berry also mentioned trade offs in other services. The police, for example, no longer handle animal control, the township contracted with the city for use of its dog warden. The neighborhood watch and crime prevention programs are also of township origin, says Berry.

"For a department that was used to coverage just the city we've done the job very well in the township," Bery said. He disagrees that the split in service between the two communities is closer to 50-50. "We have the police station in the heart of the city. That alone guarantees more patrol in the city," he said.

One answer to current questions over shared police service might be the creation of an overall police authority, says Berry, with a set millage for both city and township residents.

The city administration's original budget for the department was \$786,515. Graper's latest estimates on costs for the year are \$798,043.



community births

Kristofer Steven Karol, was born to John and Carol Ann Karol, 7350 Willow Creek Drive, Canton, on Jan. 7 at St. Mary Hospital in Livonia. He weighed eight pounds, seven ounces.

Kristofer has a sister, Tiffany.

Grandparents are Mr. and Mrs. Stephen Karol of Royal Oak and Mrs. James A. Dalsiel of Ferndale.

Kevin and Kristin Jantovsky, 235 Adams, Plymouth, are the parents of a son, Gregory Michael, born January 8 at Botsford General Hospital, Farmington.

Grandparents are Larry and Pat Jantovsky of Garden City and Bruce Campbell of Plymouth. Mrs. Heloise Dunstan of Dexter is a great-grandmother.

Time will tell in cable TV progress

BY DAN BODENE

When examining the promises and performances of cable television in The Plymouth-Canton Community, one fact always comes to mind - it is a new area.

In the words of Gary Dell, executive director of Information Services for Wayne-Westland Community Schools, "As with other aspects of cable, there are few absolutes. Most communities are 'living' with their first franchise and finding that a great deal of time is spent with creative problem solving."

To begin, first franchises for The Plymouth-Canton Community were

signed with a new company.

All three units of local government appointed task forces to study various cable TV company franchise offers in 1979. Up to then only Plymouth and Canton had any prior experience with franchising, both with ill-fated agreements in 1973. Plymouth had contracted with Howard Sharpley of Alden Cable TV, while Canton had an agreement with Canton Communication Systems, Inc.

All three local municipalities eventually signed with Omnicom.

An important distinction should be

made: the company that signed franchises with Plymouth, Plymouth Township and Canton in 1979 and early 1980 has undergone several changes, including new ownership and management.

The changes are still going on. Last week Hugh Jencks, former programming director later transferred to Omnicom's franchising department, was fired after Omnicom failed to sign a franchise with Farmington. "I didn't expect it," Jencks said Monday. "Basically, for all intents and purposes the company reduced its franchising staff by one person. Omnicom is reassessing its franchising effort. It had nothing to do with performance, or job assessment, it was just that the job wasn't there anymore."

But in 1979, things were going well for Omnicom's operation in the community. The company's founders, John Raines and Leo Harty, actively pursued franchises throughout the metro area says Bill James, president of the cable TV division of Capital Cities Communications, Inc. The hitch was that Omnicom did not have enough financing, and turned to Capital Cities for backing.

That didn't sit well with Noel Culbert, then Canton Supervisor. "I voted against Omnicom," he says. "I didn't believe Omnicom could deliver. When they came in, they didn't have financing. Lo and behold, one day before the agreement was signed, they came in with a letter of credit from Capital Cities. I think they used the franchise to get credit."

James says Omnicom officials did tell the City of Plymouth of the financing situation, before that agreement was inked in July. In November, 1979, Capital Cities bought Omnicom with Raines, Harty and Jeff Dorn as principal officers. A year later, all three left the company.

Since then, Capital Cities, through Omnicom, has worked diligently to get the system built. Many community leaders, residents and customers, however, have raised questions as to whether the company has worked on expansion at the expense of refinement.

Numerous complaints have been registered on installation problems. Citizens advisory committees complain of limited involvement. Local municipalities are reluctant to make broad use of access, while schools and libraries anxiously



analysis

await equipment so that they can make use of it. Independent channel operators do not yet have signed contracts.

Peter Newell, president of Omnicom, says the problems are unavoidable with the logistics of growth experienced by his company. Newell states, quite rightly, that few precedents exist and most persons do not know what to expect from cable television's local programming. A large number of installations and a low disconnect rate points to a general overall satisfaction, however.

But it isn't just the satellite station offerings that provide threat potential in cable television. Local access has always been a key aspect of every system, yet in The Plymouth-Canton Community development of local access has been slow.

Channel operator Denny Campbell suspects it is because Omnicom has not provided enough public relations work to get the idea of local access off the ground.

Omnicom officials point to the fact that their company has done quite a bit of promotional work and has trained more residents in the use of cable TV equipment than all other metro companies combined. "We don't know why the training is not being utilized," says Newell.

That disturbing question is one that is not easily answered. With the phenomenal number of new installations each week, why aren't community residents more interested in exploring the potential of cable television? Is it as Marshall McLuhan predicted wryly, that "Nothing fails like success?"

Probably not. The obstacles in cable TV are certainly not insurmountable - indeed, with time, hard work and cooperation the system may become all it can be. James seems to think so. "We're very happy with the reception we've gotten already," he says. "And we will have other services to follow."

There are a lot of people who are counting on it.

Omnicom's local history is short

Any history of Omnicom in The Plymouth-Canton Community must be measured in months, not years.

Bill James, president of the cable television division of Capital Cities Communications, Inc., which owns Omnicom, says it all began with John Raines and Leo Harty's pursuit of cable TV franchises in the metro Detroit area. The team was very successful, James admits, and in the summer of 1979 they discussed an agreement with the City of Plymouth although Omnicom did not have the finances to begin a system and said so.

"They went to Cap Cities two or three months later for financing," James recalls. The Plymouth agreement was signed in July, Northville Township signed theirs in September, Plymouth

Township signed in December and Canton passed its cable TV ordinance in February, 1980.

"John and Leo ran Omnicom for about a year," James says. "Meanwhile, Cap Cities bought the company in November, 1979. It was the first cable TV company we invested in, and now we have 51 - mostly out west and down south."

Raines and Harty left Omnicom in October, 1980 and Peter Newell was named president of the company. Also in the fall of 1980, "We decided the system was not being built properly," James says. "We decided to go with 400 megahertz and 52 channels instead of 35 channels and 300 megahertz."

Since then, efforts have been mainly devoted to getting the system built, James says.

for 77 years . . .

A TRADITION

SCHRADER

Funeral Home, Inc.

280 South Main Street, Plymouth 453-3333

Edwin A. Schrader, Jr.

Edwin A. Schrader



Come Worship With Us

Your Guide to Local Churches

Geneva United Presbyterian Church

5835 Sheldon Rd. Canton
453-0013

Worship Service and
Church School
Sunday 9:30-11:00

Kenneth F. Gruebel, Pastor

Plymouth Church of the Nazarene

41550 E. Ann Arbor Tr.
453-1525

Carl R. Allen, Pastor
Sunday School 9:45 am

Sunday Services 11 am, 6 pm
Midweek Service (Wed) 7 pm

First United Methodist Church

45201 N. Territorial
453-5280

John N. Granfell, Jr.
Thomas E. Sumwalt
Frederick C. Voeburg

Worship & Church School 9:15 am
Worship & Children's Church 11:15 am

Church of Christ

9301 Sheldon Rd., Plymouth
453-7630

Gary Rollins & Bob Kirkley
Sunday Bible School 9:30 AM
Sunday Worship 10:30 AM
(Children's Bible Hour)

Sunday Evening Worship 6:00 PM
Wednesday Bible Study 7:30 PM
(Nursery Available)

People's Church of Canton

Reformed Church in America
Plymouth Canton High School

Sunday Worship 10:00 am
Sunday School 11:30 am

Rev. Harvey Heneveld, 961-0488
Nursery Available

Full Gospel Church

291 East Spring
2 Bks. N. of Main
2 Bks. E. of MW St.

Pastor: Frank Howard
Church 453-0323

Home 688-9808
Sun. Bible School 10:00
Sun. Worship 11:00 am & 6 pm
Wed. Night Bible Study 6:30 pm

glimpse at yesterday



Main Street's first paving job

THERE WAS NO REASON FOR ONE-WAY STREETS off Plymouth's Main Street in 1907 when this picture was taken. Road crews, using horse-drawn

equipment, are shown preparing Main Street for its first paving job.

Schoolcraft sets choir auditions

Auditions are being scheduled for choir singers who wish to participate in a Schoolcraft College Community Choir-Plymouth Symphony performance in April.

There are currently openings for bass, tenor and alto vocalists, and additional sopranos to be added when balance permits. Choir director Marilyn Jones says auditioners should meet at 7:30 p.m.

in Room 310 of the Schoolcraft College Forum building during regular rehearsal nights. Interested singers can call Shari Clason at 349-8175 for details.

On Monday, Feb. 8 auditions will be held for those interested in a solo quartet during the April concert. Auditions will be held at the First United Methodist Church of Plymouth on North Territorial west of Sheldon. Interested persons are

asked to call 455-6420 before Feb. 3 for an audition time.

The concert program will include Beethoven's Mass in C Major, Opus 86, under the direction of Marilyn Jones; and a premier performance of Robert W. Jones' "A Plymouth Symphony" conducted by Johan van der Merwe. The concert will be held April 25 at 4 p.m.

REMODELING

Residential & Commercial

- Kitchens
- Baths
- Family Rooms
- Recreation Rooms
- Custom Bay Windows
- Wood Window Replacements
- Aluminum Storm Windows and Doors
- Wood Replacement Doorwalls
- Aluminum Siding, Trim, Gutters
- Brick•Block•
- Cement Work

NO JOB

TOO SMALL

Charles B. Cash 453-5388
Michael Lockwood 455-5320
Michael Kisabeth 459-3319

**C.
CASH
THE BUILDER**

Ladies...

reduce fast!

2 FOR 1



LIMITED OFFER! CALL 459-4040 NOW!

- Luxurious Exercise Area
- Resistant Programs
- Nursery (Slightly Extra)
- Shower, Locker & Dressing Facilities
- Hair Dryers
- Sun Tanning Area
- Aerobics
- Sauna Room
- Aerobic Exercise
- Weight Control Programs Designed for Quick Results
- Figure Fitness Analysis
- Conditioning & Weight Loss Guidance
- Dancersize
- Mini Teen Program
- Group Exercise



Member of International Physical Fitness Association

TOTAL HEALTH

45188 FORD RD. CANTON
ACROSS FROM MILLER THIRTY ACRES
IN TOTAL HEALTH SPA PLAZA

SPA

Spa Hours:
Mon.-Fri. 9-9
Sat. 9-1

2ND MARKDOWN



SAVE UP TO
50%

SACKS

550 Forest Ave.
Westchester Square Shops
459-7940

SKIRTS • BLAZERS • BLOUSES • DRESSES

Main Street Hair Company
HAIR CARE FOR THE ENTIRE FAMILY
772 S. Main
Plymouth
455-3377
Vicki Adamczyk Ursula Hempelmann

Low-Salt Industries, Inc.
"It's easy" "It's safe" "It's simple" "It works"
Trim away those pounds and inches... NOW!
NUTRI-TRIM CLUB
Meets every Tuesday at 7 p.m.
at Plymouth Cultural Center
525 Farmer St.
No Fees! No Dues! No Contracts!

Gary B. McCombs, P.C.
Certified Public Accountant
Business and Personal
Accounting and Taxes
7340 Burgundy
Canton
455-8208

30% OFF
ALL WATCHES & 14kt
GOLD EARRING'S
Delta Diamond
485 S Main St
455-1220

Edward B. Trachtman
D.O.
Practice of Family Medicine
Serving the
Plymouth-Canton
Community
Plymouth Professional Building
9416 South Main Street
Plymouth, Mich., 48170
Office Hours Telephone:
by Appointment 455-2970

RESTYLE
Your Wide Lapel to 3 1/4"
Suits and Sportcoats
Expert hand tailoring
Quality Work
Satisfied Customers
For over 25 Years
PROMPT SERVICE
Custom Made Suits
from \$300
Other Alterations Also Available for Men & Women; Personal Fittings
Lapham's
Men's Shop
349-3677 Northville
Open Thurs. & Fri. 9 a.m. to 9 p.m.
Mon.-Tues.-Wed.-Sat. 9-6

Emily's World is open to everyone

Emily Guettler would love to show you her World.

Since the opening on Jan. 4 of "Emily's World," Guettler continues to offer the travel services she has provided in 26 years in the travel agency business (and another with the United Airlines Stewardess Service), except that she is now owner of the firm.

"I started in travel when 'package tours' as such were just beginning," she says. "While the increasing number of package itineraries now make it possible

Commercial artist finds the image

A portfolio is to a commercial artist what a catalog is to a salesman. Both are used to sell.

While the salesman sells his product from A to Z, the artist sells only a person.

And for one Plymouth resident, it's the key to his future success.

"My portfolio," explained 21-year-old Tyrone Sally, a senior in commercial art at Madonna College, "is a concrete example of the confidence I have in my talent and myself."

The son of Adam and Ruth Sally of Ann Arbor Trail, Sally has wanted to be a commercial artist ever since his sophomore year at Canton High School. While he excelled in all his art classes, he said he chose commercial art rather than fine arts because he isn't "the starving artist type."

"There's a lot of money to be made as a commercial artist, as long as you don't get trapped in any one area," said Sally, who works part-time at Bill Knapp Restaurant in Plymouth. "In my field, versatility is the key to success."

In his classes at Madonna College, Sally has designed posters, signs, record albums, billboards, tickets and newspaper ads in preparation for his future career. In addition, he has earned on-the-job experience through cooperative education placements with employers in his field. Working with Richard Savard, Westland, a commercial art major at Madonna, Sally put over 100 hours into redesigning a workmen's compensation brochure for a Southfield law firm.

When designing a brochure, Sally said he keeps in mind both the consumer and client.

"You may have a terrific idea, but if it is not what the client needs, then it's no good. Any ad has to make consumers want the product." He continued, "My job is to create the one image that will sway them."

Chamber dues cheaper

Canton businesses, take heart - something now costs less than it did last year.

The Canton Chamber of Commerce is announcing that 1982 membership dues have been reduced by 20 per cent.

The new dues structure for business, industrial and professional is set at \$40 for new membership; \$60 for one to 10 employees; \$100 for 11 to 50 employees; \$150 for 51 or more employees; \$175 for utilities; \$15 for individual, non-voting; and \$25, for clubs or organizations.

to serve many people with a 'pre-arranged' tour, it still does not suit the needs and requirements of everyone."

Since the time and cost involved in vacation travel represents a considerable outlay, Guettler explains, the trip should be planned with the greatest degree of consideration for the traveler's needs. When a package tour doesn't adequately serve the purpose, a more personalized trip should be investigated.

"I have been fortunate to have experienced a fair amount of travel myself," says Guettler modestly. "And find this is of considerable importance in assisting my clients as to what is worthwhile, both in time and cost."

Indeed, she has visited a good part of the world - including 28 states, 11 islands in the Caribbean, Bermuda, Mexico, four Scandinavian countries, Russia, eight European countries, the United Kingdom, Near East, Far East and right across the border in Canada.

From fishing in the Bering Sea at -30 degrees, to stories of the Himalayan "Yeti" and donkey rides in Greece, Guettler has accumulated quite a

practical knowledge of the places her clients can also visit.

One hint she offers is that one of the best vacation bargains right now is cruises, due to reduced fares or free air service to the point of embarkation. A cruise, she says, is an easy, relaxed, worry-free vacation. One thing she says not to worry about is an agency fee:

"One of the biggest messages a travel agent has to get across is the fact that there is no charge for our service," Guettler points out. "Tickets here cost the same as they do at the airlines. The airlines, hotels, etc. pay a commission to the travel agent for promoting their services."

The slogan of Emily's World - For the Fun of It!

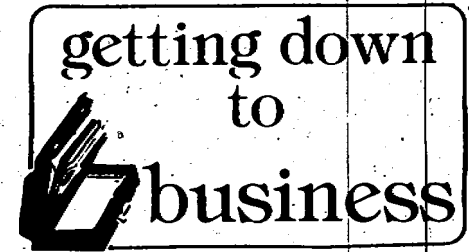

COMMA an updated and expanded Crier division

The Community Crier has updated and expanded its graphics and printing efforts into a new division: comma.

Formerly, The Crier's job printing and composition division was known as Waynco Graphics, a company which The Crier took over from Associated Newspapers of Wayne last March.

"These creative types we have here never stand still," said Crier Publisher and Chairman W. Edward Wendover. "They're always looking for creative ways to improve and grow - especially with our own company."

The new divisional reorganization does not affect personnel. At the helm of

comma will be Cynthia Trevino, sales and design consultant, and Nancy Hayes, production manager. Business offices for comma are located in Fleet Street, home of The Crier, at 1226 S. Main St., Plymouth. The phone is 453-6900.

"comma is simply a short way to stress our committed community communications and better reflects what our publishing company's goals have always been," Wendover said. "While Waynco Graphics has enjoyed a history of business, its whole emphasis was changed once The Crier took it over and its name and structure increasingly became outmoded."

Used oil can be recycled

Don't dump that oil - recycle it. In Michigan, an estimated 15 million gallons of used oil are dumped each year down sewers, in holes in the ground and in empty lots, landfills and fields. The practice not only wastes a valuable resource, it is dangerous and illegal.

Dumped oil contaminates groundwater, and can eventually enter the food chain at many points. Only five parts per million in water can be tasted and smelled. The Great Lakes have long been polluted by motor and machine oil dumped into sewers.

All that oil can be put to a much better use. Re-refined oil is as good, if not better, than new oil. Utilities and industry also reprocess used oil for fuel and other products.

In Plymouth, there are four places to take recycled oil. First, though, drain it into a reusable container such as a milk or cider jug. Then, take it to Doug's Standard, 789 W. Ann Arbor Trail; Denver's Gulf, 307 Starkweather; B and F

Auto Supply, 1100 Starkweather; or Fishaw and Sons, 210 W. Ann Arbor Rd. Michigan will be a better place for it.

Canton man is one of top Chevrolet sales managers for 1981

John Rogin, 3819 Hanford, Canton, sales manager for Mark Chevrolet in Wayne, has been singled out as one of the top Chevrolet sales managers for 1981 - no mean accomplishment in these days of auto sales slumps.

Setting sales marks in the auto sales business is not unusual for Rogin. In past years he was named Dodge national sales leader and as an employe of Don Massey Cadillac he was named winner of the Cadillac Man of the Year award.

Discussing his sales success he said, "I have heard there is a recession. I have decided not to participate."



Here's to you, Ronald

DONATING \$400 from the sale of 1982 coloring calendars to the Ronald McDonald House at Children's Hospital in Detroit is Bob Card (left), owner of the McDonald's of Canton, here presenting a check to the namesake himself, Ronald McDonald. Card says, "I would like to thank our customers for their support of this program by purchasing these calendars. Ronald McDonald House is a home for the families of seriously ill children, enabling them to remain close to the sick child. The home is truly 'the house that love built,' and we wish to show our appreciation to those people who made it possible."

Sunday Dinner Crafts shows held in Mayflower lobby

A series of Sunday Dinner Crafts at the Mayflower Hotel in Plymouth has been inaugurated, to provide yet another source of enjoyment for dinner guests.

Each Sunday from noon to 8 p.m. a local artisan will demonstrate a craft in the lobby of the hotel.

Upcoming presentations include those by Don Schneider (whose works are displayed at the Detroit Institute of Arts and Toledo Museum of Art), who will demonstrate the making of glass beads on Jan. 24; Theresa Ohno of Plymouth, an

established authority on basket weaving, who will feature the art of Great Lakes Indian coil basket weaving on Jan. 31 and origami (paper folding) on May 16 and 23; and Ellice Kulik, owner of The House of Ellice in Plymouth Township, who will weave wool on Feb. 7 and 14, paint china dolls on May 2 and 9 and spin wool on July 25 and Aug. 1.

Other craftsmen include John Groot of Canton, formerly of Greenfield Village, who will demonstrate the craft of pewter making on Feb. 21 and 28; Bob Kaiser, also a Greenfield Village alumnus, who will display examples of his rug hooking on March 7 and 14; and Ed Prudlow of Plymouth, who will display many pieces of his stained glass on March 21 and 28.

The crafts series will run throughout the year. For a complete schedule, contact Scott Lorenz at 453-1620 or write to him at 827 W. Ann Arbor Trail, Plymouth 48170.

getting down
to
business

Jones named associate publisher of Monthly Detroit magazine

Canton resident Tom Jones has been named Associate Publisher of Monthly Detroit magazine.

Jones, celebrating his 10th year with City Magazines, Inc. (parent corporation of Monthly Detroit), has been advertising director for the magazine since its founding in April, 1978.

His new responsibilities include

overseeing business, marketing, promotion and circulation of Monthly Detroit as well as advertising.

Jones, his wife Tina (who is an advertising account representative with The Community Crier), sons Jeff, Tim and Buster and daughters Melanie and Valerie reside in Sunflower subdivision in Canton.

Local merchants appointed to business council

The Plymouth-Canton Community will be well-represented on the Michigan Small Business Advocacy Council established by the state legislature.

Governor William Milliken has appointed Don Gargaro II, 7641 North Territorial Road, Plymouth; Frank A. McMurray, 39605 John Drive, Canton; and Paul A. Van Hull, 46331 Curituck, Plymouth, to the council which will advise and assist the Small Business Development Division of the Office of Economic Development, serving as a focal point for the receipt of complaints, criticisms and suggestions concerning the policies and activities of state agencies which affect small business.

Gargaro is president of Gargaro Company, Inc., a sewer, water and land development company. McMurray is an agent for State Farm Insurance Company. Van Hull is president and owner of March Tire Company, Inc.

Hoisington now vice president of Chambers group

Beverly Hoisington, Plymouth, of C. L. Finlan and Son Insurance Agency, has been elected vice-president of West Suburban Area Council of Chambers.

Membership in the Council includes Chambers of Commerce representing Plymouth, Canton, Belleville, Farmington, Livonia, Northville, Novi, Redford Township, Romulus, Wayne and Westland.

The Council was formed in 1978 to promote Chambers of Commerce unity in the west suburban metropolitan area with the objectives of supplementing, complementing and serving each other through cooperating voluntarily.

Other officers are Ray Leach, Livonia, president; Margaret Halava, Farmington, recording secretary; and Joyce Wheeler, Westland, corresponding secretary.

Working women workshop set

An all-day workshop for working women, presented by Performance Training Associates in Livonia, will be held Jan. 30 from 8:30 a.m. to 5 p.m. at the Hyatt Regency Dearborn.

According to Joan Tester of Performance Training Associates, a firm which "works with business and industry to increase employee effectiveness and productivity," women hold two of every five jobs and the number of women working (43 million) has doubled in 20 years.

Described as fast-paced and action-oriented, the workshop will take participants through a special achievement process, designed for the upwardly mobile.

The Women...Leaders workshop cost is \$85 including materials. To register, call 261-0410.

Juvenile Books
Childrens Gift Ideas
Educational Playthings
Smurf

Rainbow Shop

873 W. Ann Arbor Tr.
459-5580

Domino's Pizza Delivers.™

Fast...free 30 minute pizza delivery and 10 minute pick-up service.

7252 Sheldon
Phone: 453-3040

Limited delivery area
©1981 Domino's Pizza, Inc.

CADILLAC DRAPERY CO.
WINTER CLEARANCE SALE

Large Markdowns on Everything
30 to 40% off
All Sales Final

CADILLAC DRAPERY CO.

1227 Main St.
(Next to Plymouth Historical Museum)
Open Mon.-Sat. 9:00-5:30

Dr. Richard Heligman
Medical and Surgical
Foot Specialist

Practice of FAMILY FOOT CARE

BENTLY CLINIC - 851 S. Main
Between Ann Arbor Rd. & Ann Arbor Tr.
Saturday Appointments Available
All Insurance Plans Accepted

By Appointment **455-3669**

Sports

Canton High gymnasts edge NF

Canton High's women's gymnastics team took its first step towards qualifying for the state meet last Wednesday, despite narrowly losing a meet to state-ranked North Farmington, 116.3-115.35.

The Chiefs now need three more qualifying scores to compete as a team at the state meet.

"I was pleased with the score," said coach John Cunningham, "but we still have a way to go. This is the first time that our potential has been realized."

Canton was ahead for most of the meet, but lost points in the balance beam competition.

Laura Michalik led the squad, capturing first place overall, in addition to finishing first in the parallel bars, with a score of 8.4, and first in vaulting, 8.1.

Sophomore Linda Beale also contributed to the win, scoring second in the vault, 8.2, and third on the bars and in the floor exercise, with scores of 7.45 and 8.05, respectively.

The Chiefs next meet is Monday, when they face Ypsilanti High at home.

Cunningham said, "We will have to be at our best to beat them."

The meet will begin at 7 p.m.



SALEM GYMNAST Suzanne Gibbons starts a maneuver on the balance beam during last week's match with Dearborn. (Crier photo by Robert Cameron)

Family night for Salem-Bentley cage contest

On Tuesday (Feb. 2) Family Night ticket prices will be offered for the Salem-Livonia Bentley basketball clash, scheduled to begin at 6:15 p.m. with the junior varsity contest.

Dad pays the full price of \$2, while mom pays \$1 and up to two school children (no older than middle school) can get in free. Additional children will be admitted on donation.

High school student tickets will be sold at the door. There is no pre-sale. Two high school students can see the game for the price of \$1.

Rock spikers win Monday, 2-1 overall

Salem High's womens volleyball squad upped its overall record to 2-1 with a Suburban Eight League win over Dearborn Edsel Ford, 13-15, 15-11, and 16-14.

Coach Jeanne Martin cited her entire team for improved effort and said, "I play all 12 of my squad. They are in and out so swiftly no one of the ends up being especially outstanding."

"We're stressing team volleyball right now," Martin continued. "The biggest thing we did against Edsel is we got our service up - it's really starting to improve."

Last Wednesday the Rocks knocked off conference opponent Belleville in two straight games, 15-4 and 15-8. Again Martin stressed the team work of her squad.

"The offense is starting to come around. It's not terrific yet, but it's coming," Martin said.

Salem travels to conference foe Allen Park tonight for a 7 p.m. match. On Saturday, the Rocks will co-host the Plymouth Volleyball Invitational.

Rowdies win

The Flip Rowdies, 19 and under women's soccer team, won its division of the indoor season with a 3-2 victory over the Warren Rowdies Saturday.

The Rowdies compiled an 8-0-2 record. Kim Patterson of Livonia scored both Rowdies' goals with Kim Reeves of Plymouth assisting on both tallies.

Salem gymnasts improve in loss

Salem High's womens gymnastics team had a good second week of action, according to coach Kathy Kinsella. The Rocks dropped two duals, but improved in all areas of their sport, said Kinsella.

Salem fell to Suburban Eight League foe Trenton Monday night, 99.5-77.55, and lost to league foe Dearborn, 98.2-77.1 last Wednesday.

Against Trenton, Salem's Sue Kozar scored a third in vault, 5.85, while Suzanne Gibbons and Laura Anieros tied for fourth, 5.6, and Debbie Bahna was sixth. Bahna was also sixth on the parallel bars.

Sarah Rubadue was third on the bars, 6.4, and Julie Mann was fifth, 4.35.

Gibbons also scored two fifths for Salem; one on the balance beam, 4.85, and one on floor exercise, 6.70.

Salem's top finishes against Dearborn were Rubadue first on the bars, 6.1, Anieros third on bars, 4.50, and Gibbons third on beam, 5.35. Gibbons was also fourth on the vault.

The Rocks will host Farmington Harrison at 7 p.m. tonight.



SALEM SPIKER Sarah Wallman sends the ball back over her head during last week's match with Belleville. (Crier photo by Robert Cameron)

Don't Miss the Savings!
Fiber Glass Insulation Rebate
Insulate Now
Save up to \$40.00

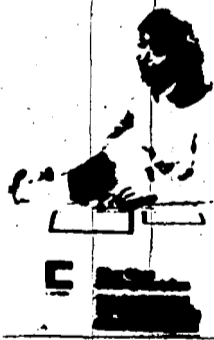

CertainTeed offers you a bundle of savings:

Buy now and we'll rebate \$1.00 on every package you buy of CertainTeed 6" thick R-19 Unfaced Fiber Glass Insulation—up to \$40.00 per household. Insulate now—and save on winter heating bills, summer cooling costs. And your purchase may qualify for federal and/or state income tax credits.

CertainTeed has the right rebate on the right product—if you act right now!

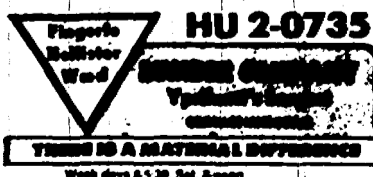

ON MICHIGAN AVENUE, JUST FEW MINUTES WEST OF I-275

CertainTeed Fiber Glass Insulation

JV coach gets varsity cage reins

BY DAVID CALLAHAN

Phyllis Cunningham, a part of the Canton High women's basketball tradition for the last several years, has been named as the new head coach for the squad.

Cunningham, a Plymouth resident, is a graduate of Plymouth High School, and Alma College in 1978. She is currently working at Central Middle School in the alternative education program.

In addition to compiling a 32-18 record as Canton's junior varsity coach for three seasons, Cunningham's coaching experience includes a one year stint as junior varsity coach for Alma High School, and one season as head coach at Schoolcraft College.

Cunningham's squad for 1982-83 will include five players from last season's 18-3 team, coached by Mike McCauley. In addition, the squad will include several players from Cunningham's junior varsity squad.

Following the footsteps of a coach like Mike McCauley is no easy task, says Cunningham. "It's hard to follow Mike," she said. "His teams won the league (Western Six) for five years in a row. He did a tremendous job for the program."

Next season, Canton will begin competition in the new Western Lakes League, which features Livonia Bentley and Salem High, two perennial powerhouses for women's basketball.

"One of our problems in recent years has been our weak schedules. We will have a real good schedule next year, and I'm looking forward to it," said Cunningham.

Cunningham has looked at several people for the assistant coach position, but has not yet made a choice. As for the outlook on next year's squad, Cunningham said, "It will be a rebuilding year, but a good year. The program will be good."



PHYLLIS CUNNINGHAM

Rocks win wrestle invite

Salem High's men's wrestling squad racked up its second first place in tournament competition this season winning the six-team Monroe Invitational Saturday.

The Rocks scored 163.5 points, while Monroe Catholic Central, the top rated Class B school in the state, was second, 135.5 points. Ida finished third, Monroe fourth, Tecumseh fifth, and Belleville was sixth.

"The team did a really good job. We were very pleased to win the tournament against some tough competition," said Salem coach Ron Krueger.

The Rocks had four individual champions at the invitational.

Marty Piper defeated Wood of Belleville on a pin at 4:45 to win the heavyweight class for Salem.

Rob McDonald won the 132-pound class with a 4-2 decision over Langton of Monroe.

Bruce Bachman, at 145 pounds, won his class with a 20-5 decision over Keiter of Ida and Randy Beaudoin won the 155-pound class for Salem with a 7-5 win over West of Monroe. **cont. on pg. 38**

Winter softball classic in Canton

Griffin Park, in Canton Township, will be the scene of some winter madness this Saturday at the 3rd Annual Groundhog's Day Softball Classic, staged through Canton's Parks and Recreation Department.

Thirteen teams are entered in the all-day competition that will battle through the worst weather Mother Nature can dish out.

Spectators can watch the games for free at Diamonds 1 and 2 at Griffin Park on Canton Center Road. Games will be seven innings in length, or one hour, and each team will field 10 players.

Teams from Plymouth, Canton, and Novi will begin competition at 8:30 a.m. with two games. There will also be two games at 9:45 a.m. and 11 a.m. There will be one contest at 12:15 p.m., and two at 1:30 p.m.

Semi finals will be held at 2:45 p.m., and the final game will be at 4 p.m.

Volleyball

CANTON TOWNSHIP
PARKS & RECREATION DEPARTMENT
W-L-T

Week 9	
Willow Creek Dental #1	9-1-0
Net Heads	7-3-0
Willow Creek Crushers #2	5-3-2
Republic Finest	4-5-1
Adistra Corp.	2-7-1
Houdek	1-9-0

Chiefs 2nd at wrestle invite

BY DAVID CALLAHAN

Almost, but not quite.

That was the story Saturday for Canton High's wrestling squad, as the Chiefs finished second out of 17 teams at the Rochester Adams Invitational.

The Chiefs tallied 142 points, and were just a half point shy of the championship, losing to Holly High, which scored 142.5 points. Third and fourth places were close also, as host Rochester Adams was third, 139.5, and Saginaw High fourth, 139.0.

"This is a good step for us," said coach Dan Chrenko, whose squad had its highest finish of the year. "Our kids did a super job. They hung in and fought all day long." **cont. on pg. 40**

WINTER SALE

15% discount on
THERMAL STORM SLIDERS
the Permanent Solution to Your Metal Window Problems!

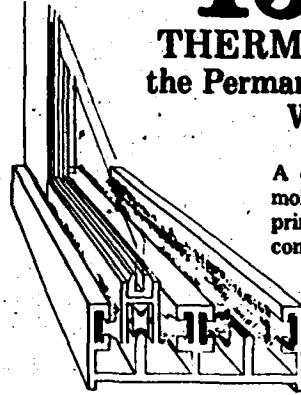

A completely sealed unit designed to keep the warm, moist inside air from getting to the cold metal of your prime window. The result is the virtual elimination of condensation, icing, and drafts.

MAYCOCK BUILDERS

CALL NOW
FOR FREE IN-HOME DEMONSTRATION
AND ESTIMATE
453-2777

STAN'S

**DISCOUNT
PRODUCE
CENTER**



38741 ANN ARBOR RD.

464-0410

HOURS: MON-SAT 9-7

PRICES GOOD THRU
SATURDAY, JANUARY 30, 1982

CHUNK CHEESE SALE

- AMERICAN (White or Yellow)
- Co-JACK
- COLBY
- HOT PEPPER
- MONTEREY JACK
- MOZZERELLA
- MUENSTER
- ONION & CHEESE
- PIMENTO
- MILD PINCONNING
- PIZZA CHEESE
- PROVOLONE

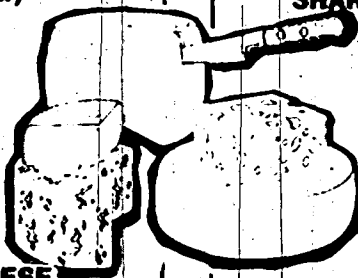

- CHEDDAR CHEESE SHARP
- DANISH HAVARTI
- NEW YORK SHARP
- PEPPER JACK
- HOFFMANS SUPER SHARP
- AMISH SWISS CHEESE
- DOMESTIC OR GERMAN SWISS
- LORAIN SWISS
- JARLSBERG CHEESE

\$1.88 LB.

\$2.68 LB.

Hamburger from Ground Chuck \$1.68 LB.	Sweet D'Anjou PEARS 49¢ LB.	Golden Ripe BANANAS 4 LBS. \$1
20 LB. BAG GENERIC BIRD SEED \$2.99 BAG	DANNON YOGURT Two 8 oz. Cartons \$1.00	50 LBS. UNCLASSIFIED MICHIGAN POTATOES \$3.99
Lean Sliced Boiled Ham \$1.99 LB.	Fresh APPLE CIDER \$1.99 GAL.	Large Green BROCCOLLI 99¢ EA.

Salem cagers fall to Fordson in a wild contest

BY KEN VOYLES

For Salem High's men's basketball team it was an unusual Friday night as compared with its four previous outings.

The Rocks had their coach ejected from the game, two key starters foul out, and in general lacked in the execution department to fall to non-league foe Dearborn Fordson, 61-48.

The Rocks sported four straight wins until Friday. Salem is no 8-3 overall and 5-0 in the conference.

"It was a lack of execution on our part and when we needed the points they just wouldn't go down," said Salem coach Fred Thomann. "There were two or three critical times late in the third quarter when we had scoring opportunities that we didn't convert. We needed to convert them if we were to win the game."

Less than two minutes into the first quarter Thomann was charged with two technical fouls after an outburst over a missed call during a full pressure defense by Fordson. The official said he made his calls for two reasons, "frequency of the coaches mouth," and "because he swore."

Thomann denied he swore. It was the first time he has been thrown out of a game, he said, after being ejected at the 3:41 mark of the fourth quarter, angry over a missed five-second call. Fordson again converted three of four and led, 50-40.

Back in the first quarter Salem stayed close, 11-8 at 3:23, and 15-12 at quarter's end.

The Rocks continued to fight from the hole in the second quarter closing to 19-

18 at one point. Halftime score was 27-21, Fordson.

The Rocks exploded at the start of the second half and scored the first eight baskets to take the lead for the first time, 29-27.

Fordson didn't allow the Rocks to turn

the tide completely, however, and the two squads exchanged the lead twice before the Tractors got back on top for good, 33-32; at 4:27. Fordson drove away to a 41-34 score at the end of the quarter.

cont. on pg. 40

Salem grapplers win 2nd tourney

cont. from pg. 37

Salem's John Beaudoin finished second at 138 pounds when he lost to Umin of Monroe Catholic Central, 5-3, in the finals.

Salem's John Wochuck was second at 167 pounds when he lost to Lehmann of Monroe Catholic Central on a pin at 2:41, while Scott Wickens was also second. He lost to Connors of Tecumseh, 7-4, at 185 pounds.

Tom Walkley scored a third place for Salem, at 198 pounds, as he pinned Fox of Ida at 4:57 in the consolation finals.

Mike Doumanian was also third for Salem, as he knocked off Vargis of Tecumseh, 10-6 in the consolation finals

at 112 pounds.

At 98 pounds, Salem's Rick Vershave finished fourth as he lost to Drewior of Monroe, 3-2, in the consolation finals.

Bill Hall was also fourth for the Rocks as he fell to Zuzar of Monroe, 11-8, in the consolation finals.

Salem's John Jeannotte, a 119 pounds, and Steve Grytza, at 126 pounds, both lost their first two matches.

Earlier in the week the Rocks dumped Suburban Eight League foe Dearborn, 67-3. Salem won all weight divisions except 121.

Salem will next face conference opponent Belleville tomorrow night at home starting at 6:30 p.m.

Salem swimmers drop 1st dual

Salem High's men's swim team suffered its first dual meet loss of the season Thursday as it fell to Suburban Eight League foe Dearborn, 49-34.

According to Salem coach Chuck Olson his squad turned in plenty of second and third place finishes but failed to score as many first places as the team needed to win. "The meet really was closer than the score indicated," Olson added.

Russ Shaffer won the 200-yard individual medley for Salem, 1:59.6, while Mark Roehrig was third, 2:12.9.

Joe Rudelic won the diving competition with 255.95 points. Todd Riedeil was second, 180.5.

Tim Harwood won the 100-yard freestyle with a time of 53.1 seconds, while John Thompsnn was third, 53.6 seconds.

Scott Anderson was third in the 200-yard freestyle, 1:59.6, while Roehrig was second in the 100-yard butterfly, 58.9 seconds, and Jeff Kleinsmith was third, 58.9 seconds.

Scott Stinebaugh finished third in the 500-yard freestyle with a time of 5:50.1, while Shaffer scored second in the 100-yard backstroke, 1:01.2, and Paul Neschich was third, 1:02.

Ashley Long was third in the 100-yard

breaststroke, 1:06.6.

Salem's crew of Neschich, Long, Jeff Kleinmsith and Bob Bowling were second in the 200-yard medley relay with a time of 1:48.2, while the 400-yard freestyle team of Eric and Jeff Kleinmsith, Anderson and Harwood were also second, 3:33.

Salem also scored third in that race as the team of Bowling, Roehrig, Thompson and Shaffer clocked 3:37.9.

Earlier in the week the Rocks dumped non-league foe Northville, 122-49.

Against the Mustangs Long scored first in the 200-yard IM, 2:18.2, and the 500-yard freestyle, 5:37.9.

Other Salem firsts included Anderson in the 200-yard freestyle, 58.5 seconds; Thompson, 50-yard freestyle, 24.2 seconds; Rudelic, diving, 281.65; Jeff Kleinsmith, 100-yard butterfly, 57.9 seconds; and Roehrig, 100-yard backstroke, 1:03.7.

The Rocks will swim Belleville tomorrow at home starting at 7 p.m. "Belleville has been erratic this year, but they've always swam good against us," said Olson. He added that this week will be a crucial one for his swimmers in terms of dropping their times.

don't forget

Deadlines for the

'82 GUIDE

are close upon us, and every year we hear from advertisers who tell us "I wish I'd been in **THE GUIDE.**"

Because the Guide is a book that's used all year as a reference, we thought we'd take this opportunity to remind our friends and neighbors who, (like us!) sometimes remember right after the deadline.

Call your Crier ad consultant quickly at 453-6900.

'82 GUIDE to The Plymouth-Canton Community



Community
The Crier



Chief cagers falter at Churchill

BY DAVID CALLAHAN

Canton High's basketball squad continued its downward slide on Friday, as the Chiefs fell to Western Six League Rival Livonia Churchill, 52-34.

Canton is now 1-10 overall, while the victory gives Churchill a 2-9 record.

"We just didn't attack their zone defense very well," said Dave Van-Wagoner, Canton coach. "We also had some problems with turnovers."

Turnovers played an important role in the cagers defeat, their sixth consecutive loss. Partly because of turnovers and missed opportunities, the Chiefs got out to a slow first quarter start.

Churchill, meanwhile, had no problem in getting the ball inside to center Tom Gomolak, who had nine points in the first period to give the Chargers an 11-6 lead at the end of the period.

While Churchill continued to roll in the second period, Canton's offense went to sleep, as the Chiefs did not score a single point until 25 seconds were left in the half.

Churchill built up a 21-6 lead until Matt Thomas had a tip-in with 25 seconds left. Thomas then hit a free throw, and added another tip in to cut the Churchill margin to 21-11 at the half.

The Chiefs slipped farther behind in the third period, and Churchill built up a 17 point lead by the end of the quarter, leading 35-18.

Churchill finally put Canton away in the final period, opening up a 22 point lead, its biggest of the game, before allowing Canton to pull back to 18, and walking off with the victory.

Ron Rienas led the Chiefs attack with eight points, all of them coming in the final period. Thomas added seven, and Mike Scarpello had six. Gomolak led all scorers with 17 points.

Canton's junior varsity was more fortunate, beating their Churchill opponents, 52-37. The Chief reserves are

Chief spikers

2-2 overall

Canton High's women's volleyball squad dropped to 2-2 overall last Wednesday as the Chief spikers fell to Western Six League rival Livonia Churchill in three games, 15-4, 8-15 and 13-15.

"We just had an off day," said coach Cyndi Burnstein. "We were not playing the way we usually do."

Burnstein added that Churchill did not have that many good spikers or servers, but that the team was faster than the Chiefs. "We got beat at the net," Burnstein said, "and we didn't take control of the game. Churchill started to play better, and we didn't."

Canton opened up an early 11-1 lead in the first game, as Churchill struggled to get into the contest. After the opening game scoring burst, the Chiefs could do no more on offense, and dropped to 1-1 in the conference.

Burnstein said that both Polly Roberts and Kim Elliott played well in the Chiefs losing effort.

Canton's next match is tonight, when it travels to Farmington Harrison for a conference clash. The meet will begin at 7 p.m.

now 7-4 overall, and 4-0 in conference play. Canton was lead in scoring by Scott Matties with 14, and Mark Bennett with 11.

Canton plays again Friday, when they face state-ranked Livonia Stevenson at home. Game time is 6:15 p.m. for junior varsity.

Canton swim team wins another dual, 5-2 overall

BY DAVID CALLAHAN

Canton High's men's swim team continues to dominate competition in the Western Six League, beating Livonia Churchill, 110-62, on Thursday.

The victory raised the Chiefs' record to 5-2 overall, and 2-0 in the conference.

The Chiefs placed first in each of the 11 events except for the 100-yard breaststroke, in which they were second and third.

Pete Stern led the way for the Chiefs, garnering first places in the 50 and 100-yard freestyle races; Stern set a pool record of 22.83 seconds in the 50, while he clocked 50.76 seconds in the 100.

In addition, Stern was also a member of the Canton foursome that captured the 200-yard medley relay. Stern, Jim Luce, Ron Hurley, and Pete Sickels finished in 1:50.53, while the other Canton quartet, comprised of Greg Schnurstein, Joe Gibbons, Matt Krawzak, and Bob Lewelling was third, 1:57.39.

Canton swept the 500-yard freestyle, with Bob Simone leading the way with a time of 5:14.42. Scott Simmons was second, 5:26.64, and Glen Plagens third, 5:40.38.

Simone and Simmons also finished in the 200-yard freestyle. Simone was first, 1:54.30, while Simmons was second, 2:01.45.

Sickels was a finisher in both the 200-yard individual medley and the 100-yard backstroke. He won the individual medley, 2:17.41, and was second in the backstroke, 1:07.08. Hurley was second in the medley, 2:18.98, and Lewelling clocked a first in the backstroke, 1:05.76.

In the 100-yard butterfly, Gibbons was first, 1:03.68, while Krawzak clocked 1:07.84, good for second.

Canton won the diving competition, as Jerry Fleischer scored 169.70 points. Craig Vanderburg finished third, with 144.30 points.

Canton's 400-yard freestyle relay team of Gibbons, Simmons, Simone, and Plagens clocked, 3:40.33, for first, while the other Canton squad of Krawzak, Lewelling, Scott McIntyre, and Matt Rupprecht, finished third, 4:04.50.

In the 100-yard breaststroke, the only event Canton did not win, the Luce brothers, Jim and John, took second and third, respectively. Jim's time was 1:07.80, good enough to edge John's time of 1:08.79.

Canton next swims against Farmington Harrison. The meet will be held tomorrow and will begin at 7 p.m.

Phone 459-0404.

HAIR TEND'S
FAMILY HAIRSTYLING
BY APPOINTMENT & WALK-IN

PINE TREE PLAZA
39475 Joy Road
Canton, Michigan

Alan R. Faber, Jr., D.D.S.

announces the opening of his office for the practice of General Dentistry

995 SOUTH MAIN STREET
PLYMOUTH, MICHIGAN 48170

Afternoons & Evenings
by appointment

Telephone
459-2100



UNO
International Games, Inc.
Presents

THE WORLD'S LARGEST INDOOR MIDGET AUTO RACE

Heroes vs Outlaws
Saturday, Jan. 30
Pontiac Silverdome

<p>64 cars competing on a 1/4 mile indoor dirt track Last year's entries included</p> <ul style="list-style-type: none"> <li style="width: 33%;">★ Johnny Parsons Jr. <li style="width: 33%;">★ Rick Ferus <li style="width: 33%;">★ Joe Suckow <li style="width: 33%;">★ Poncho Carter <li style="width: 33%;">★ Larry Rice <li style="width: 33%;">★ Mel Kenyon <li style="width: 33%;">★ Sammy Swindell <li style="width: 33%;">★ Steve Kinser <li style="width: 33%;">★ Doug Williams <p>Sanctioned by W.O.M.</p>	<p>Heat Races 2:00 pm Adults-only \$5.00 Children (12 & under)-only \$1.00</p> <p>Featured Races 8:00 pm Adults-only \$8.00 Children (12 & under)-only \$1.00</p>
<p>Tickets available at the Pontiac Silverdome, 1200 Featherstone, Pontiac, Michigan 48057 or Order by mail, enclose check or money order or charge to VISA or MASTER CHARGE with stamped, self-addressed envelope to American Productions, Inc. 26011 Evergreen, Suite 320 Southfield, Michigan 48076 Be sure to indicate how many tickets for which event you are ordering. For additional information, call (313) 352-0155</p>	



CLEARANCE SALE

 <p>HOCKEY</p>	<p>All protective Hockey Equipment</p>	<h2>40% off</h2>	
 <p>Woolrich Clothing</p>	<p>★ Coats ★ Vests ★ Shirts</p>	<h2>25% off</h2>	<p>Mountain Parkas Reg. 79.95 Now Just \$59.95</p>
 <p>CCM MUSTANG HOCKEY SKATES</p>	<p>All Bauer and CCM Hockey Skates</p>	<h2>25% off</h2>	<p>Reg. \$84.95 Now Just \$63.95 Junior Mustang at comparable prices</p>
<p>Assorted Sport Jackets</p> <h2>50% off</h2>	<p>Entire stock of cross country ski equipment</p> <h2>25% off</h2>	<p>Ski Package Value \$148.50 Reg. \$119.50 Now \$89.95</p>	

PLYMOUTH

TRADING POST

QUALITY SPORTING GOODS

1009 W. Ann Arbor Rd.
Mon-Thurs 9-6
Fri 9-8
Sat 9-6

453-0022

\$3.50 for the first
10 words, 10¢ each
additional word

Crier Classifieds

Deadline:
Monday 5 pm
Call 453-6900

PG. 41 THE COMMUNITY CRIER: Jan. 27, 1982

Articles For Sale

AFX Pursuit slot car set, Reg. \$64.50, SALE \$30.00. PLYMOUTH HOBBY, 453-1997.

THE NEW "DIET PILL"
SPIRULINA
NOW AVAILABLE, 455-0959

Used Appliances, 42285 W. 7 Mile, 349-4766.

Fisher AM-FM receiver 9 watts per channel New. Realistic 80M. Speakers with super tweeters \$75. 981-5976 or 459-0584.

John Wayne portrait Original 28½" by 48½", metal storage shelf 6 ft. tall, twin lamps China and brass trim, cast iron roaster, exeter donut baker - electric, cream jacket - short size 13, white coat fake fur leopard spots size 13-14, white rabbit hat, ski sweater brown & beige size large, cowboy hats white & beige size M. Disco dress size 13. 372-8350.

Glass bath tub enclosures, seven-foot air hockey table, ping pong table, five-piece bedroom set. Huge moving sale, 455-5655.

Articles for Sale

Living room/recreation room set. Large, gold couch, two matching gold, crushed velvet chairs. One teak cocktail table & end table. Good Condition. \$135. 453-1887.

Income Property

UNIQUE
Renovated historical building Ypsilanti central business district. First floor commercial income. Luxurious apt. upstairs, 3,000 sq. ft. fireplace, garage, planted deck with hot tub. \$149,000 terms, 482-8872, or 482-8290.

For Rent

Ply. Area 3 bedroom ranch, family room, basement \$550. per month 455-4451.

Would like to share our 4 bedroom house in Plymouth. ADC Mom OK \$200.00 a month includes utilities. 455-8177.

Apartment to share, 2 bedroom furnished, air conditioning, pool, rent \$175.00 per mo. all utilities included 453-5387.

For Rent

PLYMOUTH. HEAT furnished, One bedroom apartment, carpeting, appliances included. Adults only. No pets, available March 1, \$275. 459-9507.

Pets

Professional Poodle & Schnauzer grooming in my home \$9.00 Plymouth-Canton area, 459-1241.

LOST- black & white Husky puppy, 12 wks. old, Ford Rd. & Sheldon 455-0838.

Wanted

ARTS & CRAFTS - Exhibitors interested. Dearborn and Livonia shows. Right Summit Productions, Box 5261 West Bloomfield, Mich. 48033.

Clean used double mattress and box spring. 455-8629.

Situations Wanted

Understanding mother looking for children of any ages to care for in my home. Any hours \$1.25 per hour, references available, 459-9436.

POSTING AND FILING OF CITY COMMISSION MINUTES City of Plymouth, Michigan

Notice is hereby given that on the 27th day of January, 1982, true copies of the minutes of the City Commission meetings held on November 16, 1981, December 7, 1981 and December 21, 1981, were posted on the official bulletin boards of the City of Plymouth, located at the intersection of S. Main and Penniman; the intersection of Starkweather and W. Liberty; the south entrance of the Central Parking Lot facing S. Harvey; and also on the bulletin board at the City Hall, at 201 S. Main Street. These minutes are posted in accordance with Section 5.11 of the City Charter for the benefit and information of all interested citizens of the City of Plymouth.

GORDON C. LIMBURG
CITY CLERK

Publish: January 27, 1982

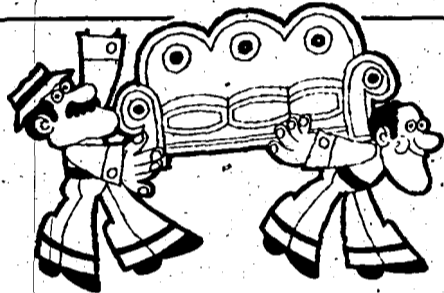

Crier Classifieds
get
RESULTS!

Call 453-6900

Crier classifieds

Reach the people
in YOUR community

Call: 453-6900

or clip & mail this form today!

10 Words-\$3.50
Extra Words-
10¢ each

Deadline:

Wednesday's Paper

Write Your Ad Here:

Mail to:

The Crier
1226 S. Main St.
Plymouth, Mi. 48170

Your Name

Phone

Address



Charter No. 16393

National Bank Region No. 7

REPORT OF CONDITION, CONSOLIDATING DOMESTIC SUBSIDIARIES OF THE FIRST NATIONAL BANK OF PLYMOUTH

IN THE STATE OF MICHIGAN

at the close of business on December 31, 1981
published in response to call made by Comptroller of the Currency,
under title 12, United States Code, Section 161

ASSETS

	Thousands of dollars
Cash and due from depository institutions	2,787
U.S. Treasury securities	1,299
Obligations of other U.S. Government agencies and corporations	3,400
Obligations of States and political subdivisions in the United States	335
All other securities	114
Federal funds sold and securities purchased under agreements to resell	10,500
Loans, Total (excluding unearned income)	18,354
Less: Allowance for possible loan losses	159
Loans, Net	18,195
Bank premises, furniture and fixtures, and other assets representing bank premises	860
All other assets	479
TOTAL ASSETS	37,969

LIABILITIES

Demand deposits of individuals, partnerships, and corporations	10,161
Time and savings deposits of individuals, partnerships, and corporations	17,830
Deposits of United States Government	3
Deposits of States and political subdivisions in the United States	6,294
Certified and officers' checks	282
Total Deposits	34,570
Total demand deposits	11,381
Total time and savings deposits	23,189
All other liabilities	416
TOTAL LIABILITIES (Excluding subordinated notes and debentures)	34,986
Common stock-No. shares authorized 107,500	
No. shares outstanding 107,500 (par value)	1,075
Surplus	1,075
Undivided profits and reserve for contingencies and other capital reserves	833
TOTAL EQUITY CAPITAL	2,983
TOTAL LIABILITIES AND EQUITY CAPITAL	37,969

MEMORANDA

Amounts outstanding as of report date:	
Standby letters of credit, total	125
Time certificates of deposit in denominations of \$100,000 or more	6,091
Average for 30 calendar days (or calendar month) ending with report date:	
Total deposits	31,799

I, J. P. Perrot, Sr. Vice President of the above-named bank do hereby declare that this Report of Condition is true and correct to the best of my knowledge and belief.

J. P. PERROT

January 15, 1982

We, the undersigned directors attest the correctness of this statement of resources and liabilities. We declare that it has been examined by us, and to the best of our knowledge and belief is true and correct.

KENNETH D. CURRIE
WILLIAM M. SEMPLNER
MARIAN R. KEHRL
Directors

\$3.50 for the first
10 words, 10 each
additional word

Crier classifieds

Deadline:
Monday 5 pm
Call 453-6900

Situations Wanted

Relax, Mother of 5 yrs. wishes babysitting for children of any age. Days-Nights or Weekends. Lots of Love, toys, meals, etc. Joy Rd. & I-275, 465-2385.

Relax at Work! Mother with 8 yrs. experience will watch your child with loving care and supervision. Meals, books, records, marching games and toys, toys, toys, all ages, days-evenings, weekends, rates negotiable. References if needed. Canton-Plymouth area, close to I-275, 455-8868.

INDIVIDUAL OR FAMILY EXCHANGE WITH ENGLAND.

New England travel concept, an inexpensive cultural exchange. Interested? Send or call for details. Contact the U.S. Tour Representative: Lancing Travel, Joan Robinson 21226 Glenhaven Cir., Northville, MI. 48167, 349-9198.

Lessons

Piano or Organ Lessons in your home. Stanford G. Walling Instructor, 39 years experience 721-4586.

Music Student wishes to give piano lessons in her own home, reasonable rates - qualified accompanist. 455-3103.

Piano, organ, vocal. Mr. Ronnie Phillips 20 years experience, formally with Anderson Music. 453-0108 lead-sheets & arrangements.

Services

ABORTIONS
Convenient locations, experience GYN-Physicians. Insurance-ADC-Medicaid accepted. Prompt appointments. 722-8357

Services

Hypnosis for Smoking, Weight Loss, etc. Universal Self-Help Center, 729-2290 or 697-7348.

ACE RADIATOR SERVICE - open 7 days & evenings. Certified Mechanic. Repairing, Recoring, also gas tanks. 33509 Michigan Ave., Wayne. 326-6616.

Assistance for problem pregnancy - free counseling services. Pregnancy testing. Helping women since 1972. Womens' Center, 476-2772.

Individual Income Tax preparation call Joanne C. Harnett, attorney at law, 459-3034.

Dressmaking, mens and womens alterations, jeans repaired, Peg 455-5370.

DID YOU KNOW: You can buy hospitalization insurance for as low as \$10.38 per month at FIRST STATE INSURANCE PLYMOUTH. 459-3434.

All appliances serviced - \$8 service charge with this ad. All makes, one day service. Guaranteed, call 455-6190.

EXTERIOR & INTERIOR PAINTING, GENERAL MAINTENANCE JOBS. EXPERIENCED - FREE ESTIMATES, 459-3197.

Siding, trim, gutters, repairs, lowest rates, first quality, 495-0948 Canton.

Want housework, Mon., Tues., Wed., & Fri. 453-0867.

Mending, patching & darning, reasonable, 453-3891.

Firewood

DRY OAK AND Seasoned Maple \$50.00 Delivered DICK PACKARD 455-3822

Firewood 16" to 18" lengths delivered not split, \$30. a cord minimum 5 cords or \$34 for 4 cords and less. 682-5484.

Vehicles For Sale

1975 Datsun B210, good mileage, good transportation 326-0891.

'76 Firebird, auto, ps, pb, air, am-fm stereo, very good condition, 453-8145.

Curiosities

Thanks M. & V. the flowers are beautiful. fish

JEAN HALFMANN are you staying warm?

Attention Has-Beens - Buck Night, Mon., Feb. 1, 7 p.m. at Holly By Golly.

EYE CATCHERS

Mistles, candlelights, environmentals, and so much more to add that special touch to your wedding photography. Rawlinson Photography 453-8872.

Eat, Drink & Be Married. - N. Hayes, 1982.

Only nine days left to get your entries in for The Crier's annual Cooking Contest.

Pizza Prima presents perfect pizza . . . promptly! Call 453-2900.

Karen - Better now than later. Visit anytime - Love, Nan.

Why me?

NOTICE: If I catch your cat (in vicinity of Main St. and Rose) ripping up my garbage again, I'll dispose of your pet. (Humanely, of course.)

THE ALL NEW '82 GUIDE to The Plymouth-Canton Community is coming.

WATCH LIVE LOCAL NEWS Mondays through Fridays at 6:50 p.m. on Cable Channel 13.

CONGRATULATIONS Bob Delaney. The jury's not still out on the big case.

SATTLERS: super super party.

DOES HELEN VARIAN, of Peekskill, N.Y. read the Curiosities? If she does, she'll know it's her birthday. Happy Day.

SCOTT, CREON - thanks for the tickets. The game was super even on short notice. B & E.

DEADLINES for The '82 Guide to The Plymouth-Canton Community are fast approaching.

JESSICA doesn't really need those tonels anyway. By tomorrow, they'll just be a specimen in Dr. Ritter's laboratory. Good luck kid.

JIM DREWRY gets his new nose from Dr. Ritter TODAY. Do the doctors give fleet discounts?

"I don't like burned waffles. They're hateful." - Jessica.

Thank Steve for bringing us home alive from our ski expedition Friday. The Plymouth Landing Business Men's Closed after 1 o'clock Fri. lunch club.

Karen & John Sattler really know how to throw a Super, Super Bowl Party.

Service Directory

ALTERATIONS
Quality Work
Experienced Tailor
Repairs, Leather Work,
Coats Lined,
Blind Hem Machine.
Reasonable
6 MI. & 275 420-0173

TRIM LINE PAINTING
Winter Special
We buy the Paint
You pay just the labor
Quality work, references
Free Estimates. Call Bob
485-0872

Kitchens - Baths
Additions-Rec-rooms-
Aluminum Siding-
Replacement Windows
Roadside Kitchens
Licensed Builder #18837
459-2186

AUTO UPDATE

Tom's Custom Auto

Body Repair and Painting inc. imports
Reconditioning & Waxing interior & engine cleaning
453-3639 770 Davis (old village, Ply.)

459-9744
459-9745
ELITE COLLISION
Bumping and Painting
Insurance Estimates
FREE LOANERS
Jim
936 Ann Arbor Rd. Plymouth

PIT STOP
Quick Oil Change (10 Minutes)
\$16.99 plus tax
903 Ann Arbor Road
455-9430
Open Monday thru Saturday 8 am to 6 pm.

Full Service Station
Open Sundays for your convenience -- 10-5 p.m.
Doug's Standard
A Full Service AMOCO Station
Corner Main & Ann Arbor Trail 453-9733

P.A.M.O.
PROFESSIONAL AUTO MAINTENANCE
Unique New One Stop Auto Maintenance Service
"We can handle ALL your Auto Cleaning, Body Repairs and Service."
744 Wing St.
459-3794

MOBAYON AUTOMOTIVE

Specialists in complete auto conditioning
Buff & Wax Interiors•Engines
455-3370
9165 GENERAL COURT PLYMOUTH

Storage

Western Wayne County's finest mini-self-storage. Servicing the greater Plymouth-Canton area. Storage Unlimited. 459-2200.

Fruit Baskets

DO-IT-YOURSELF and save . . . 1 peck and 1/2 peck Fruit Baskets with handles, plastic wrapping material (gold cellophane), 6 inch deluxe tie-on-bow and card, all included for only \$3.00 each. All you add is the fruit. Call 453-6787.

Firewood

Apple, Ash, Cherry, White Birch, Maple, Red and White Oak are all included in a "DELUXE MIX" that hundreds are more than delighted with each year, or if you prefer, all Apple or Cherry which throws no sparks, but what an aroma! For the White Birch buff, it has been split 2 years. Hardwood Only? Free kindling & free delivery, checks accepted. Hank Johnson & Sons, 8th Season. Phone persistently anytime. 7 days per week 349-3018 or 453-0994.

IN NEED OF EMPLOYABLE SKILLS? ANXIOUS TO START A CAREER?

9 & 14 MONTH PROGRAMS
ASK OUR GRADUATES
- PBI - FARMINGTON
Has the answer for you
Nine week terms
DAY & EVENING CLASSES

Secretarial Business
Accounting Accounting
Legal Management
Medical Data Processing
Word Processing Travel Careers*

PONTIAC BUSINESS INSTITUTE

34801 GRAND RIVER
476-3145
Financial Aid & Placement Service
*N.T.A. Approved

WANTED! DEAD OR ALIVE . . . JUNK CARS

USED AUTO PARTS . . . BRING IN OR WE TOW • HIGH DOLLARS PAID

JUNK CAR REDEMPTION CENTER

BILL WILD AUTO SALVAGE CO.

DIVISION of BILL WILD ENTERPRISES, INC.

CALL NOW FOR A PRICE
OPEN 8 AM 5 PM

326-2080

HELP KEEP OUR CITIES JUNK FREE
39223 MAPLE S. OF MICHIGAN OFF HANSON WAYNE



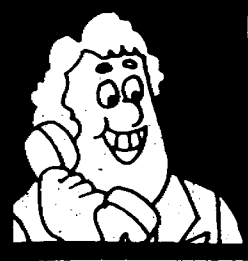

Help is just a phone call away

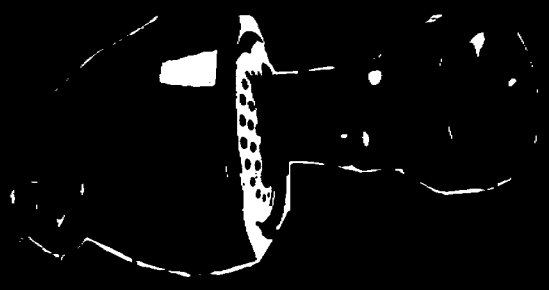

Dial-It Shopping

AIR CLEANER

COLONIAL HEATING & COOLING
484 N. Main
Plymouth
455-8880

- Heating •Air Conditioning
- Air Cleaners •Power Humidifiers
- Vent Dampers •Sales •Night & Day Service
- Licensed •Master Charge •Visa.

ALARMS

MIDWEST ELECTRONIC SECURITY
47751 No. Territorial
721-3884

Commercial and residential Security Systems installed •Keyless push button alarm systems. 24 hr. monitoring service. "We're the Fussy Ones."

ALTERATIONS

LENTS MEN'S CLOTHING
798 Penniman
453-5288

Men's Clothing and ladies tailored suits and slacks, regardless of where you purchased them. Satisfaction Guaranteed. Our own tailor on premises.

AUTO REPAIR

DENNY'S SERVICE
1088 Starkweather
Plymouth
453-8115

Front end work •Tune Ups •General repair •Certified Mechanics •\$28.00 Computer Hook-up plus 4 minor adjustments.

BAKERY

MARIA'S ITALIAN BAKERY
115 Haggerty-881-1288
39411 Joy Rd.-455-8780
41852 W. 10 Mile-348-8548

- Square Pizza •Hot Italian Bread •Sausage •Baked Goods
- Cannoles •Cake •Italian Lunch Meat •Beer •Wine.

BOOKSTORE

PLYMOUTH BOOK WORLD
2 Forest Place
455-8787
844 Penniman
455-8888

- Unique Childrens Selections
- Discriminating Magazine Corner
- Refreshing Different Cards & Gifts
- Sensational new Pickwick Club Rental Library!! Best Sellers!

BRIDAL SALON

GENEVA'S OF PLYMOUTH
17 Forest Place
Plymouth, 455-4445
3284 Plymouth Rd.
Ann Arbor-894-1118

Wedding Gowns •Accessories •Designer Dresses by Albert Nipon and Prom Gowns. Mon, Wed. & Fri 10-6 pm, Tues & Thurs 10-8:30 pm, Sat 10-5 pm.

CHILD CARE

HUGS AND KISSES CHILD-CARE & LEARNING CENTER
184 N. Main St.
Plymouth 488-8838

Year round educational pre-school •Ages 2½-9 yrs •Full-time, part-time, drop-in, E.S.Y. Programs •Licensed, Certified •Field Trips.

DANCE INSTRUCTION

DANCE TIME
Ballet, Tap, Children thru Adult
Reasonable Rates
Teacher- Sandra W. Blasey
Member of the Cecchetti Council of America
Plymouth Area
453-8438

DRIVING SCHOOL

MODERN SCHOOL OF DRIVING
28288 Vassar
Livonia
476-3222, 329-8829

State approved teen classes starting each month at Plymouth Cultural Center. Private adult lessons available.

ELECTRICAL CONT.

SAMSONOW ELECTRIC
458-1188

- Fuseboxes •Motors installed
- Plugs •Switches •Dryers
- Ranges •Violations & Repairs.

FURNITURE

LAUREL FURNITURE
Complete home furnishings. Large selection of baby furniture and clocks. Quality furniture moderately priced. Free delivery.
594 Ann Arbor Trail
Plymouth
453-4700

FURNITURE REFIN.

FURNITURE REJUVENATION UNLIMITED
Old Village-Plymouth
882 Holtbrook 488-4830

Natural & Painted Finishes •Wood Repair •Woven Seats •Hand Stripping •Wicker Repair.

HALL FOR RENT

VFW 6885 PLYMOUTH
1428 S. Main St.
Plymouth
455-8888

Wedding, Graduations, Anniversaries, Meetings, Fund-Raisers.

HEATING

PUCKETT CO.
412 Starkweather
Plymouth, MI.
453-8488

- Heating •Air Conditioning
- Plumbing •Sewer Cleaning
- Visa •Master Charge •Night & Day Service •Licensed •All Areas.

HOME IMPROVEMENT

RAY R. STELLA CONTRACTING INC.
747 S. Main-Plymouth
488-7111

Complete Remodeling Service •Kitchen planning & design •Additions •Family Rooms •Sun & Garden Rooms •Basement remodeling. Free Planning & Estimates. Full Financing.

INSULATION

AIR TITE INSULATION
882 N. Holtbrook
Plymouth
453-8258

Save on the cost of heating-cooling. Fast, professional installation . . . "your comfort is our business."

KITCHENS

RAY STELLA CONTRACTING INC.
747 S. Main-Plymouth
488-7111

The most important room of your home. Complete kitchen design & planning Service. Wood & Formica. Free Estimates & Full Financing.

LAWN SPRAYING

PLYMOUTH LAWN SPRAYING
185 W. Pearl St.
Plym. 455-7388

We would like to thank our customers for their patronage this past year. Looking forward to serving them this spring.

LOCKSMITH

THE TOWN LOCKSMITH
1278 S. Main
Plymouth
455-5448

Locks repaired and installed. Keys made for residential •Commercial •Cars (American & Foreign) •Combinations Changed house, auto, safes •Locking Gas Caps.

MATERNITY APPAREL

MATERNITY VOGUE
7363 Lilley Rd.
Kings Row Shopping Center
Canton, MI
458-8288

Fashion for the price conscious "mother to be." Great selection in all departments. Mastercharge & Visa.

MEAT MARKET

PORTERHOUSE MEAT MARKET
1888 S. Main
Plymouth 455-8778

Specializing in:
•Fresh USDA Choice Meat •Pork •Veal •Lamb
•Freezer Specials •Fresh Seafood •Homemade Fresh & Smoked Sausage •Del.

PLUMBING

JOHN J. CURRAN PLUMBING
1425 Goldenith
Plymouth
453-8822

Kohler plumbing fixtures •Residential •Commercial •Repairs •Modernization •Rheem water heaters.

RESALE SHOP

HIDDEN TREASURES
778 S. Main St.
Plym. 488-8222

Good previously owned Furnishing •Childrens toys, needs •Sporting Goods •Lots More. Monday-Saturday 10:00-5:30 Tuesday-Friday 10:00-8:00

SEAFOOD MARKET

PLYMOUTH FISH
878 Starkweather
Old Village • 455-2838

- Best Selection •Jet Fresh
- Weekly Specials •Professional Cooking Instructions •Personal Attention •Unique Party Ideas
- Catering with a Flair!

SECRETARIAL SERV.

EXECUTIVE ASSISTANTS SV.
555 Forest Avenue
Plymouth
488-8888

Complete Professional Secretarial Service •Business Typing •Correspondence •Legal •Resumes •Billing •Mailings •Phone for Dictation •Telephone Answer-Service. 8 am-6 pm

SEWER CLEANING

PUCKETT CO.
412 Starkweather
Plymouth
453-8488

Sewer Cleaning •Air Conditioning •Heating •Plumbing •Visa •Master Charge •Night & Day Service •Licensed •All Areas.

SEWING MACHINE SERVICE

PLYMOUTH VACUUM SEWING CENTER
888 W. Ann Arbor Rd. Plym.
2 blk. W. of Main-E. of Sheldon

Sales and Service all Makes and Models - 1 day Service. •Sewing Machines •Vacuums •Cabinets •Commercial Machines. 455-3500

TAXI

STAR CAB
453-2223

- 24 Hr. Service •Airport Service
- Package Pick-up & Delivery.

Ride a Star Its Better By Far Serving Plymouth & surrounding areas.

TOWING

B & B TOWING
834 Ann Arbor Rd.
Plymouth, MI.
453-3888

- 24 Hour Service •Local •Long Distance •Expressway Serv.
- Storage Facilities •Radio Dispatched.

Owner Bud Voss

T. V. REPAIR

RICK'S T.V.
42412 Ford Rd.
Corner of Lilley

Fast Service on RCA •Philco •Zenith •Sony •Magnovox •Admiral •Panasonic •GE •Wards •Sylvania •Cesee •MGA.

Antennas installed 991-4889

Winter Clearance

The Sale You've Been Waiting for!
**GRANATA FURNITURE'S LARGEST
FURNITURE CLEARANCE SALE**

**FINAL REDUCTIONS
IN EVERY DEPARTMENT!**

SAVE 40% on EVERYTHING!
Many Floor Samples, Closeouts, One of a
kinds, Discontinued items selling at

COST OR BELOW
DON'T MISS OUT
LAST CHANCE TO SAVE.



331 N. MAIN STREET ■ PLYMOUTH MICHIGAN 48170 ■ Phone: (313) 453-3370
Mon-Fri 9:30-6:00 ■ Sat 10-6 ■ Sun 10-5