



The Community Crier

20 cents

Vol. 4 No. 35

The Newspaper with Its Heart in the Plymouth-Canton Community

November 9, 1977



DAVID PUGH



MARY CHILDS



MARK WEHMEYER

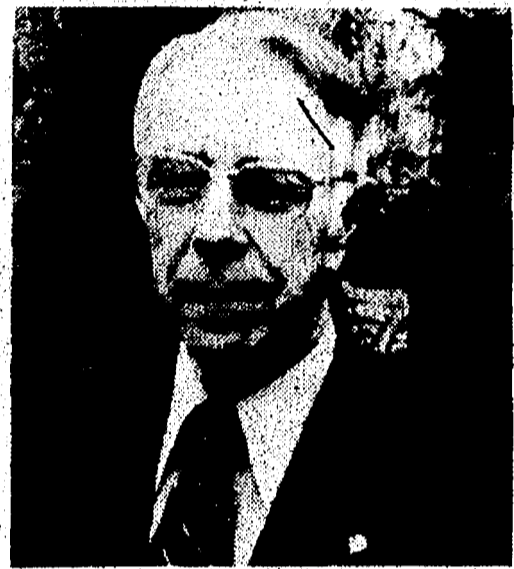

JAMES HOUK

Pugh, Childs, Houk, Wehmeyer win seats

BY DONNA LOMAS
In heavy voting Tuesday, City of Plymouth voters elected David Pugh, Mary Childs, Mark Wehmeyer and James Houk to fill four contested city commission seats.

According to unofficial results, Pugh, a planning commissioner, placed first with 1,197 votes; followed by Childs with 1,192; Wehmeyer with 1,158 votes and Houk with 1,053 votes.

Trailing the four successful candidates were Clay Fechter with 909 votes, Penny Wright

with 890 votes and John Moehle with 791 votes.

Moehle placed last in the voting Tuesday, in a dramatic reversal of his first-place finish in the August primary. Pugh placed seventh in that primary, while Childs and Wehmeyer retained their second and third places respectively. Mayor Joe Bida, who withdrew from the race shortly after the primary, nonetheless tallied 261 votes.

"Incredible!" said Pugh when he first heard the results. "It was a lot of hard work."

"No kidding," was Wehmeyer's response when he first heard the unofficial tabulations.

City Clerk Paul Brumfield said 33.38 per cent of the city's 6,132 registered voters voted

City precinct results...pg. 4

Tuesday - a higher figure than he had anticipated.

A total of 2,047 residents voted. Some 238 absentee ballots were turned in.

Pugh, Childs and Wehmeyer will serve four-year terms, while Houk, who finished fourth in the balloting, will serve a two year term.

The new commission will meet for the first time Monday, Nov. 14, city officials said. At that time, commissioners are expected to elect a new mayor.

Trustees as 'individuals' seek signatures Twp. petitions for cityhood after court boundary ruling

BY HANK MEIJER
In the wake of a Michigan Supreme Court ruling on the powers of the State Boundary Commission, Plymouth Township officials are expected this week to file petitions with the commission for the incorporation of the township as a city.

The move follows an Oct. 24 ruling by the Supreme Court which affirmed the authority

of the three-man boundary commission, acting as an arm of the state legislature, to change the boundaries of local governments in response to annexation petitions filed by the cities of Brighton, Midland and Novi.

The ruling is expected to pave the way for annexation by the City of Plymouth of the 40-acre Burroughs parking lot area now in the township. That annexation was approved

by the boundary commission in April, 1976, but an Ingham County Circuit Court judge, acknowledging the challenges to the authority of the boundary commission in annexation decisions, issued a stay which delayed the transfer of land.

Should the boundary commission be granted a release from court challenges in the Plymouth Township case, the boundaries would likely be changed soon. But township officials may appeal the case to the State Court of Appeals, or the Michigan Townships Association, on behalf of all affected townships, may appeal the original Supreme Court to the Federal Court of Appeals.

In an informal meeting at midnight Thursday, township board members decided "as individuals" to circulate petitions calling for the incorporation of the township as a city, one official said.

Trustee Maurice Breen said the petitions must bear 1,020 signatures, or five per cent of the township's total population of 20,400.

Should the boundary change in the case of the Burroughs lot - a parcel considered prime for commercial development - be approved, the township still faces city petitions, filed in

Cont. on pg. 27

Highway may alter commuter habits here

As of Nov. 21, local residents will have direct access to downtown Detroit via the newly-completed stretch of I-96 - the Jeffries freeway - which connects Detroit with I-275 in eastern Plymouth Township.

The dedication ceremony is scheduled for 9:30 a.m., but the freeway may not be open to vehicular traffic until some time later, said Warren F. Cox, senior engineer for the Department of State Highways and Transportation.

"We have to get the proper ramps open and get the people out of the way," said Cox, "Sometime later that day, the

freeway will be informally opened to traffic."

Cox said the opening would affect many east-west roads in the Plymouth-Canton area.

"Most people will want to travel the new freeway, he said. "There may be decreased traffic on east west roads and M-14 because of it."

The new freeway will be opened next year west to Ann Arbor as M-14.

Northville Road may see some "minor disruptions" this year and next, said Cox while the final construction is in process.



Coach pushes press around

FOLLOWING ORDERS from Salem High School Head Football Coach Tom Moshimer, Rock trainer Allie Suffety pushed Crier Sports Editor Chas Child away from the midfield sideline area during last Friday's game with Farmington Harrison. Child, who has been covering local prep games from the sidelines all season, was told he could not stand inside the 30-yard lines. Later in the game he was allowed once again to move freely. For more on the game and the attempt to bar a reporter from a section of the sidelines, please turn to the sports section, which starts on page 18. (Crier photo by Bill Bresler.)

Chief cagers clinch Western Six ...pg.25

Come meet the HONEST-TO- GOODNESS BIG BOY!

In person at
ELIAS BROTHERS
Restaurant.

Grand Opening

November 11, 12, 13
11am-3pm and 5-9pm

44681 W. Ann Arbor Road
Plymouth 455-8070



Big Boy is coming to town! Here's your chance to meet your favorite hero in person. Get his autographed picture and free gifts for the kids just by stopping by. Of course, if you're feeling a bit hungry, you can sit at a table and be served by a real waitress. Choose from over 100 items on a real menu. Be served with real plates and silverware. Elias Brothers, the honest-to-goodness restaurant now featuring the honest-to-goodness Big Boy in person!

You're gonna love



**We borrowed
some nice ideas
from your mother.**

Senior housing group asks city tax break

The Pilgrim Non-Profit Housing Corporation asked City Commissioners Monday night to financially support a proposed six story senior housing project on land they own.

The corporation owns two acres of land on Ann Arbor Trail between Hamilton Street and the railroad tracks. The city Commission appointed the group in 1971 to explore possibilities for senior housing.

The five owners, Robert Utter, James Houk, the Rev. R. S. Shank, Melvin Blunk, Clifford Tait, Florence Gabelman and Dr. A. E. VanOrnum asked the Commission to reimburse them and financially support the land until a decision is made.

Utter, spokesperson for the group, asked the City Commissioners to consider tax abatement for the property, reimburse the directors of Pilgrim Housing for all monies they have personally spent on the

land and to return the title and deed of the property to the City of Plymouth.

"Private citizens shouldn't continue to support it," said Utter, spokesperson for the group.

Utter said an option was now available on the property through FCH Services, a wholly owned subsidiary of Foundation Cooperative Housing.

He stated in a letter to the commission that the group anticipated the plans for the housing would materialize and that a new subsidized housing would be approved.

"The plan will take upwards to a year to be finished," he said. "During that time we will have to pay for the land."

The commission decided to present a chronology of events concerning the land at the first meeting in December to clear up events surrounding the land since 1971.



CEP presents comedy

YOU CAN "SEE HOW THEY RUN" this weekend as the Centennial Educational Park high school's drama department presents the "wild comedy" beginning this Thursday evening at 8 p.m. at the Salem auditorium. The play will run Friday and Saturday nights also. Tickets can be purchased at the door for \$1.75.

Pictured above (left to right) are Mike Wooley, with gun; Jerry Holden, priest and Mike Manning. Other members of the cast include Janet Davies, Greg Davis, Sandra Gottwald and Matt Watoba. (Crier photo by Bill Bresler.)

Canton planners find land ideas

BY CHAS CHILD

Officials from Canton Township, studying ways to save the township's farmland, recently visited Suffolk County, N.Y., where a program to preserve open and farmland has been under way for about a year.

Suffolk's program is based on buying the "development rights" of the open land. The landowner still holds the title to the property, but he can't develop it.

The trip by Finance Director Mike Gorman and Township Planner George Peek to Suffolk County was part of a \$40,000 study authorized by the Board of Trustees to investigate the possibility of setting up a development right program for Canton.

Gorman said there were 32 landowners in Suffolk eligible for the program. Of these, 21 chose to accept the County's money for their development rights.

Both farmers and developers entered the program, Gorman said.

The amount paid to the landowners is the difference between the agricultural value of the land and its open market or speculative value.

After the fee is paid, Suffolk

holds the development rights forever, said Gorman. Whether to accept the fee is also completely voluntary, he said.

Peek said the study will be finished "no later than the end of December."

If the decision is made by the board to pursue the plan then decisions such as whether the program should be voluntary or not, and how long the township will hold the development rights will be made, Gorman said.

The land in Canton under study is about 5,600 acres all west of Canton Center Road, said Peek. About 700 of these acres consist of very small parcels, and the remaining 4,900 acres are in 105 parcels, the township planner said.

These 105 parcels have about 50 to 60 owners, Peek said.

The development rights program was introduced in former Supervisor Robert Greenstein's term. Some property owners in Canton have said that the program will mean a loss of at least their land investments, but Gorman said there was very little controversy in Suffolk.

"I think the program can work in Canton," he said.

Mediator joins secretary talks

BY DONNA LOMAS

In a meeting called for late Tuesday afternoon, the Plymouth Canton Schools' Secretarial Association voted unanimously to enter into mediation with the schools' if their attorney recommended it. The secretaries called the meeting after a request to go into mediation with Michigan Employment Relations Committee by the schools' negotiator, Walter Bartnick.

The secretaries and schools are polarized on the same three issues that has tied up talks since April, said Louise Gates, spokesperson for the Plymouth Canton Educational Secretary Association.

"They are offering us a

dental plan which will cost us money to belong to, a 20 cent increase in pay the first year and a cost of living in two or three years but with a 10 cent cap," said Mrs. Gates.

"We want a better plan," she said. "We're part of the working family (in the schools' too."

"We are all women and I think that is part of the problem," said Gates. "Some secretaries were even told they just took a second paycheck home and it didn't matter."

Gates said the schools are saying they can't afford what the secretaries are asking. She said in previous years, the secretaries had received similar benefits.

Bartnick said he planned to

meet this week with the secretaries, and that the secretaries were comparing group to group within the schools.

"I still feel we should compare secretary to secretary (in other districts)," he said. "I have no further comments."

"It's a touchy situation," said Mrs. Gates. "We are falling further and further behind."

OV lights up

City commissioners approved installing more than 18 gas lights in the Old Village area at a regular Monday meeting.

The gas lights are part of a federally funded project. They will be placed in the newly-renovated alleyway between Spring and Liberty streets.

Turning truck kills pedestrian

A 56-year-old Livonia woman was killed Wednesday on Ann Arbor Road in Plymouth Township after stepping in front of a semi-trailer truck and being dragged 300 feet, Wayne County Sheriffs report.

A tractor trailer semi-truck was at the I-275 southbound exit ramp and was making a right hand turn after the light changed.

The woman, Clara Mills, was on the north side of Ann Arbor Road crossing east on the exit ramp, sheriffs said. She was hit and dragged for 300 feet west on Ann Arbor Road.

"She was walking home from a nearby store after buying some yarn," said Det. Frank Burton of the Wayne County Sheriff Department. "It was just a freak accident."

The driver of the truck was

watching traffic and the signal and did not see the woman because the cab of the truck was high, Burton said.

A witness across the street saw the incident occur and ran alongside the truck, jumped

up on a fender and yelled for the driver to stop, sheriffs reported.

The driver of the truck, from a Canadian firm, was treated for shock. No charges were made.

School panel predicts enrollment jump

If Plymouth-Canton School District enrollment climbs according to newly-released projections, the district, in which slightly more than 15,000 students are enrolled today, will boast a student population of more than 18,000 in 1980.

Those findings were released yesterday in a report delivered to a workshop session of the

school board by its projections committee.

Serving on the committee which presented its findings to administrators and the four board members in attendance were Chairman Smith Horton, Clem Bommarito, Jerry Henderson, Steve Kremenski, James McKeon, Thomas Santer, Linda Stebbins, Billy Whiteley, Joyce Willis and Roger Wright.

Four kids may still need shots

Four children in the Plymouth Canton School District have yet to report their immunization status, the schools reported Monday.

"Those students are on the Extended School Year," said Florence Beier, community relations assistant, "and they are off-track now and hard to get a hold of."

Beier said no child has been excluded from school because their immunization records are not up to date.

Canton brothers charged in pizzeria bombing

Two Canton youths were arrested last Thursday in connection with the dynamiting

of a Canton pizza parlor following surveillance by Michigan State Police, and Westland Police. Wayne County Sheriff Department was also involved in the case.

Robert Blackburne was charged with possession of explosives and placing of explosives with intent to do damage to property. The first charge carries a maximum four year penalty, the latter has a 25-year maximum penalty.

The two suspects, Robert Jay Blackburne, 17, and his brother, Donald Edward Esser, 20, were arraigned Friday.

Esser was charged with possession of explosives, police report.

Trooper Dave Gentry of the Michigan State Police Northville Post said the two were arrested in Livonia outside a shop where a transaction of dynamite occurred.

tucky, "where it is easy to purchase," said Det. Sheedy.

"They gave no reason for doing it other than being destructive," said Trooper Gentry.

Det. Thomas Sheedy of the Wayne County Sheriff Bureau, said the police knew the suspects possessed a large quantity of dynamite.

"They have had some experience with dynamite," Gentry said. "They could have done some more damage."

"The Westland and State Police decided on surveillance," said Sheedy. "They caught the two brothers selling the dynamite and later, both admitted to the bombing of the pizza parlor."

Police suspect the two had exploded another bomb in Westland, said Det. Sheedy, but they have not been charged with it.

Police said the two brothers bought the dynamite in Ken-

Both suspects have been arraigned and a tentative trial date has been set for Nov. 16 in 16th District Court in Livonia.

the Community Crier
Published each Wed. at 572 S. Harvey St. Plymouth, Mich. 48170
Carrier Delivered: \$8 a year
Mail Delivered: \$11 per year
Mailed at Controlled Circulation rates.
Plymouth, Mich. 48170

Which point is Pointe?

You can now run the chance of becoming confused whenever you pass Pointe Park in Plymouth.

The township is to develop the parcel of land as a park. At the meeting, a resolution was passed to deed the land. Deputy Clerk Linnea Salow read the resolution which named the deeded land as the "Richwine-Pointe Park."

It all depends on whether you pass Pointe Park in Old Village in the City of Plymouth or whether you pass Pointe Park at the western end of Plymouth Township.

She told commissioners the name was to distinguish between the Pointe Park already in Old Village.

At Monday's City Commission meeting, the parcel of land in the township at North Territorial and Ann Arbor Road was deeded to Plymouth Township from the city.

Commissioner Norb Battermann requested the name "Richwine" be deleted from the resolution. Other commissioners agreed by voting unanimously.

BRUNCH IN TOYLAND
The Mayflower's Famous
Hundreds of Toys will be on hand for your children to play with before, during and after the enjoyment of
The Mayflower's Famous SUNDAY BRUNCH
MAYFLOWER MEETING HOUSE
455 S. Main St.
SUNDAY, NOVEMBER 27th
9 AM to 5:30 PM
Adults \$4.50 Children \$2.25
For a Magical Christmas Preview your children won't forget—
Call now for reservations
453-1620
Because of Demand Toyland Buffet Monday November 28th
Sittings at 5pm and 7pm
Adults \$4.50 Children \$2.25
All Toys from dolls to work from game to puzzles, have arrived to meet the needs of
Plymouth Book World
Ford Road K-Mart
Jerry's Bicycle Shop
PLAYCLOTHES

Busy Bee Crafts
1082 S. Main 455-8560
Register Now:
* NEEDLEPOINT, Tues. Nov. 15, 1-3
15 Stitches, 3 weeks
* NEEDLEPOINT, Mon. Nov. 21, 7-9
44 Stitches, \$20, 5 weeks
* MACRAME XMAS TREE CLASS
Wed. Nov. 30th, 10-12, 7-9
Thurs. Dec. 1, 7-9, Mrs. Kabel
2 weeks, \$5, you must know Square Knot
* MACRAME SNOWFLAKE CLASS
Dec. 6th Tues., 7-9 p.m.
1 session, \$3, you must know Square Knot
Closed Thanksgiving

Unofficial City election results

	ONE	TWO	THREE	FOUR	FIVE	*TOT
Bida	50	22	47	42	40	261
Childs	201	108	197	265	245	1192
Fechter	120	86	165	205	264	909
Houk	161	94	195	243	195	1053
Moehle	97	73	141	159	246	791
Pugh	236	95	219	258	231	1197
Wehmeyer	177	90	223	242	334	1158
Wright	114	74	170	197	275	890
Total Voters	319	178	370	444	498	2047
Percent						33.38

*INCLUDES ABSENTEE BALLOTS — TOTAL:238.

The following is a comparison between candidates as they placed in the Aug. 3 primary this year and how they placed in last night's unofficial voting results:

PRIMARY ELECTION POSITION	CANDIDATE	FINAL ELECTION POSITION
6	JOE BIDA	---
2	MARY CHILDS	2
8	CLAY FECHTER	5
5	JAMES HOUK	4
1	JOHN MOEHLE	7
7	DAVID PUGH	1
3	MARK WEHMEYER	3
4	PENNY WRIGHT	6

Haze Wilson, Community Relations Manager, Livonia, reminds you:

There are things you can do to control the cost of your phone bill.

We are constantly searching for ways to help you economize on your phone service, but here are just a few ideas on how you can help yourself:

Call when it's least expensive. For example, when you're calling long distance, dial direct and plan your calls for times when the rates are lowest.

Budget Service that's really low budget! Look into the availability of Budget Service if you don't make a lot of phone calls every month. It's the least expensive one-or-two party phone service we offer.

Plan to have all your service installed in one visit. For instance, if you move, plan carefully so the installer doesn't have to make extra trips, for which you may have to pay additional charges. And while you're planning for new service, make sure it's going to be the kind most suited to your needs.

Sometimes, little tips can save you a surprising amount over the long haul. We'll keep trying to help you save.

Michigan Bell...
people who enjoy serving people.

Michigan Bell

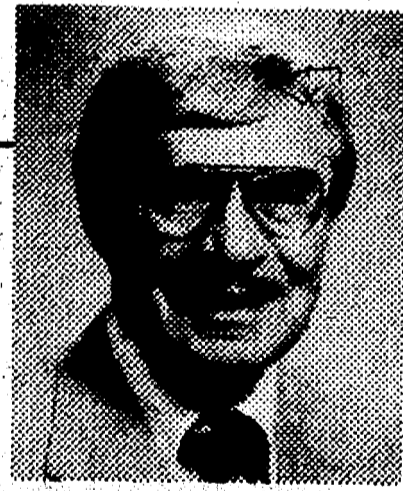

OPEN thru Nov. 20th
OPEN DAILY 10 a.m. to 8 p.m.

PARMENTER'S NORTHVILLE CIDER MILL

714 Old Baseline Road
6 1/2 miles E. of Sheldon
1 1/2 miles S. of 8 Mile Rd. 349-3181

Since 1873

Freeze Cider for the Holidays!

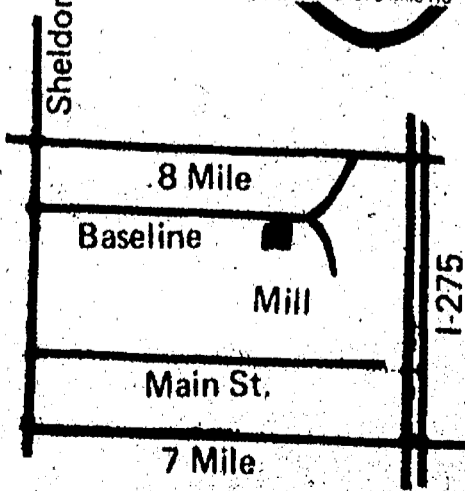

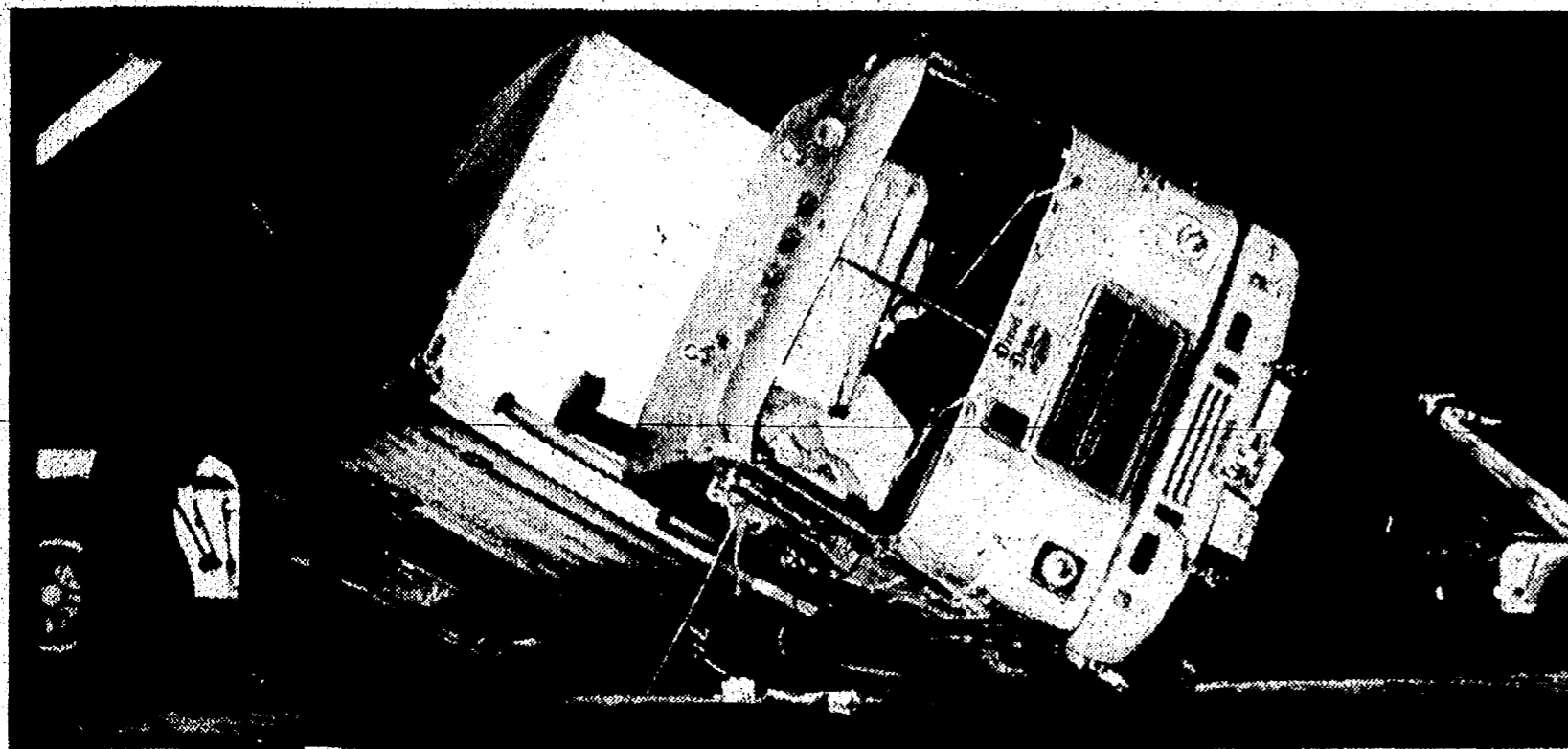

Canton studies county cop rental

BY CHAS CHILD

An offer from the Wayne County Sheriff Department to sell police protection to Canton produced reactions ranging from skeptical to "still studying" from the Board of Trustees.

"I haven't formulated a final opinion on the offer," Supervisor Harold Stein said. "The cost is the most important thing. I'm still investigating it."

The sheriffs' first offer during a presentation at last Tuesday's board meeting was to cover the township with two patrol cars of sheriff deputies all day, seven days a week. This package would cost \$431,953 per year.

Jamil Akhtar, the sheriffs' representative, also presented two other proposals which would use a mixture of sheriff deputies and Canton reserves to patrol the township.

The sheriff department's offer came despite Canton's approval in August of a two-mill, \$450,000 levy for the police which is seemingly earmarked to create a full-time Canton police department.

The Board of Trustees hired a police chief, Walter MacGregor, who has written a complete budget for a full-time department. That budget was recently approved by the board.

MacGregor has said he is shooting for Jan. 1, 1978, to start Canton's full-time de-

partment.

Trustee Lynne Goldsmith reminded Akhtar that Canton's Police Study Commission recommended that the township not contract with the sheriff department for police protection.

The board early this year adopted the commission's recommendation to enlarge the township's own department to meet Canton's needs.

The two other proposals by the sheriffs would cost \$294,386 and \$225,772. The more expensive would provide 24-hour protection provided by a mix of sheriff deputies and Canton's reserves working in the same cars, Akhtar said. The second proposal would divide the day between sheriff patrols and Canton reserve patrols, he said.

Asked if the township might lose control over its police department if the sheriffs were patrolling, MacGregor didn't want to comment specifically on the sheriff situation, but said, "Anytime you contract out anything, you lose some control over it."

Akhtar said that if the township bought the sheriff patrols, the present Canton reserve officers would become sheriff deputies, including MacGregor would be a lieutenant or a sergeant.

MacGregor said he would "respectfully decline" any such offer.

Truck flip ties traffic

NO ONE WAS SERIOUSLY INJURED last Friday evening at 8:34 p.m. when this semi truck overturned on the I-275 expressway just south of the Warren Road overpass, Wayne County Sheriffs report. The semi was travelling south on the freeway when it left the roadway and fell over a vehicle parked on the shoulder, Sheriffs said. The owner of the crushed vehicle was not in his car at

the time, police said. The driver of the truck, Richard D. Smith, 24, of Romulus, and a passenger received minor injuries. Sheriffs report Smith had been drinking and was charged with reckless driving. No other cars were involved in the crash. The Wayne County Helicopter division spotted the accident, witnesses said. Canton Fire Department assisted. (Photo by Ken Garner.)

Hospital rezoning denied

BY CHAS CHILD

A rezoning request to pave the way for a hospital in Canton was denied by the Board of Trustees last Tuesday.

The developer, Mel Stein, had previously been turned down by the Planning Commission twice. The board voted 4-3 on a motion to deny the rezoning request.

Supervisor Harold Stein, Treasurer Anne Bradley and Trustee Robert Myers voted

"no", while Clerk John Flodin, and Trustees Lynne Goldsmith, Eugene Daley, and Brian Schwall voted "yes."

Mel Stein, (no relation to the Supervisor), said that he would meet with his associates to decide whether they would pursue their plans for the hospital project, and if so, how.

The project includes a 200-bed hospital, a 200-bed nursing home and a medical office building. Mel Stein proposed

to build the project on Canton Center Road just south of Meijer Thrifty Acres.

The main reason for denial given by the board were: the project would increase rezoning pressure along Canton Center Road and Stein did not have certificate of need for the hospital from the State Department of Health.

Some trustees feared without a certificate, Stein could get the rezoning and not carry through with the hospital.

THANKSGIVING

Your host
Adam Stoja

INVITES YOU TO JOIN US
FOR GOOD FOOD AND
PLEASANT ATMOSPHERE

Ann Arbor
Road House

47660 ANN ARBOR ROAD
PLYMOUTH TWP.
GL 3-1095

Make Your
**THANKSGIVING
DAY**

Reservations Early

ON THANKSGIVING DAY

We will be featuring;

TURKEY DINNER with all the
TRIMMINGS as well as

Fresh Seafood, Italian Favorites,
Quality Prime Steaks & Chops

For Your Pleasure and
Convenience We Have Changed Our
SUNDAY HOURS

to 1 PM-10 PM

We will still be Open Daily

11- 2 AM

Mayor's job calls for 'Tactful Tom' Turner

Page Six

Community Opinions

THE COMMUNITY CRIER: November 9, 1977

Coach's conduct sets poor standard for prep gridders

Harrassment of the press vied with the action on the football field last Friday night at Centennial Educational Park.

On Salem Coach Tom Moshimer's orders, a Rock trainer forcibly pushed along the sidelines the sports editor of The Crier. ("I'm just a peon," the trainer said later.)

All season our sports editor has been covering local high school games from the sidelines. His presence has never been questioned or mentioned.

Last Friday, however, after he predicted a Salem loss in the upcoming game in that week's newspaper, he was suddenly barred from the area between the 30-yard lines on the Salem side of the field.

He got lame excuses. It's a players' area only he was told, as youngsters played nearby and photographers passed freely through the knot of players around the bench.

The 30-yard line policy is "understood," the schools' Athletic Director John Sandmann said later -- although no one has ever mentioned it before and it has never been applied to anyone else.

This is harrassment and it can't be tolerated. When our sports editor refused to leave, he was threatened with arrest by Moshimer through the trainer. (To whom does this turf belong?)

The "peon" also asked if our photographer would like his camera broken.

Is this behavior building character in our youth?

The principles-be-damned attitude exhibited by Coach Moshimer should not be ignored by school administrators.

As in any occupation, among high school football coaches you'll find some winners and some losers. The paradox is that you can have both.

Moshimer's men have won every game, but he seems to have lost sight of something more important along the way.

-- THE CRIER STAFF

If you are fighting mad...



Get it out
Write a letter
To the editor

The results of last night's city commission election came as a stunning upset to many observers, who expected to see a new commission divided along the lines drawn so often in recent months between John Moehle and Bev McAninch and the other commissioners.

It didn't happen. Voters rejected all but one member of what many saw as anti-high-rise, pro-commuter-residential slate.

With the re-election of Mary Childs and the return of Jim Houk to city government, the old guard is back in the driver's seat.

There are problems to be addressed which must not be pushed under the rug just because we may have a measure of harmony on the commission once again.

Parking downtown remains a source of confusion.

How should high buildings be built -- and where -- in downtown Plymouth? We still have to find answers to that question that will stand up to light better than the exceptions of Footnote O.

We suspect senior citizens still need better housing than is now available.

A first step toward these goals is the election of a mayor who can draw cooperation from the commissioners, rather than the squabbling we have seen so often.

Only one commissioner has shown the balance and judgment the mayor's job requires, and that's Tom Turner. You couldn't blame him if he didn't want to step into the hot seat, but he's clearly the only commissioner who combines a term's experience with an open mind and the skill to preside when difficult questions arise.

With him at the helm, we may find this new mix a constructive one -- for a change.

THE CRIER STAFF

Guess what: E-way ends here

If you've ever wondered how well known our community is, you'll want to hear how the Department of State Highways described the western end of the soon-to-be-opened I-96 expressway in a recent press release.

The expressway, which originates in Detroit as the Jeffries Freeway, runs west along Schoolcraft Road to a point here where it meets the new I-275. That point is described in the press release as "west of Livonia." Not as "Plymouth Township," or even "east of Plymouth," but "west of Livonia."

Starting Nov. 21, however, you can climb on the new expressway to Detroit in Plymouth Township. If you've never heard of the place, it's somewhere "north of Canton."

THE CRIER STAFF

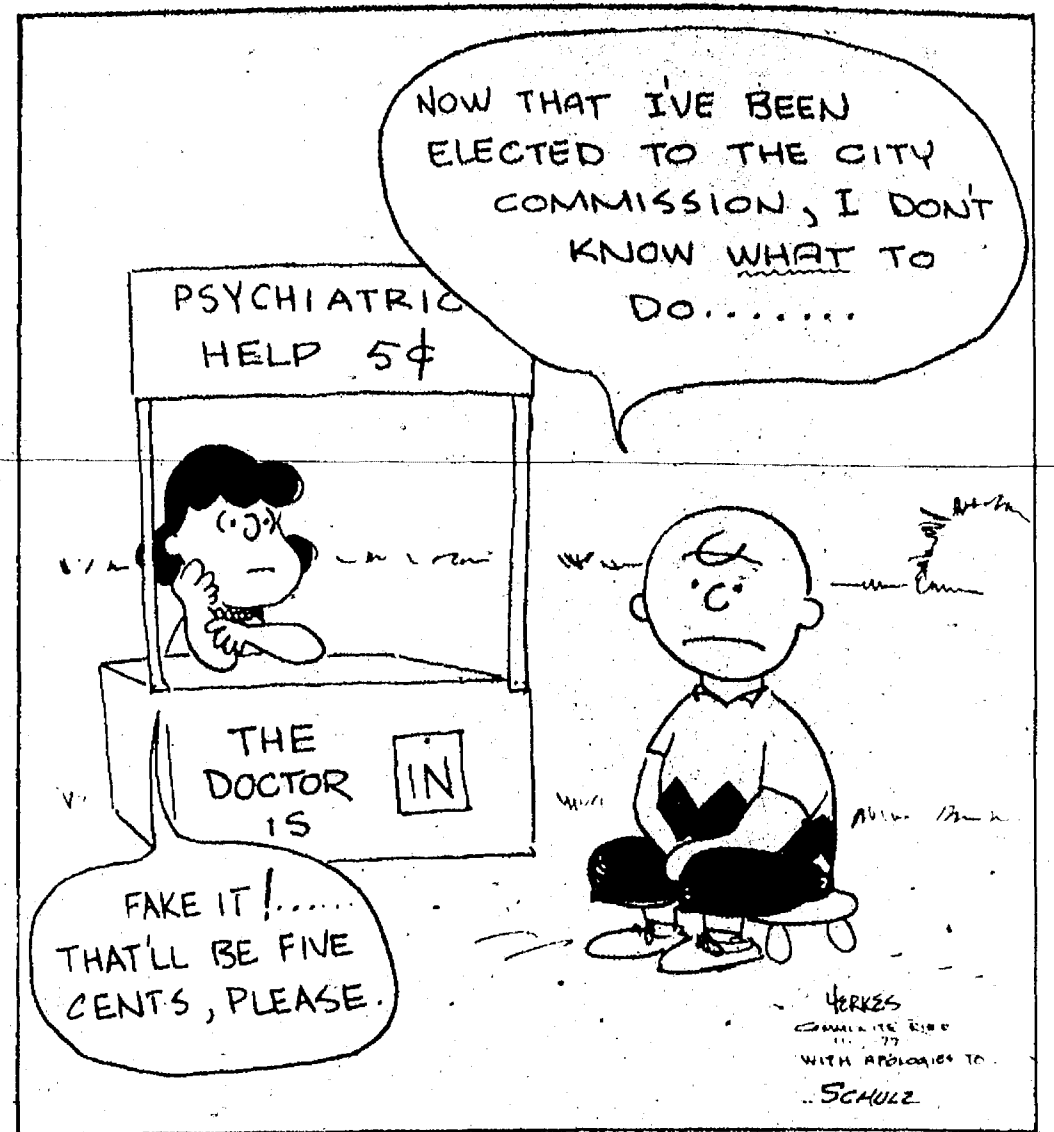

Donna Lomas



Canton library's time has come

The fledgling Canton library fund is underway. Supervisor Harold Stein opened a library fund account last month with \$10 of his own money, "just to get this thing on the road," as he put it.

The money has been trickling in slowly but surely -- there is now \$400 in the fund.

But anyone would know that it takes a lot more to open and maintain a library.

The fund has a long way to go, but with every dollar put in the account, a bit of insurance for Canton and its residents goes with it.

Canton will be assured that its community identity will grow with that fund, and the library will be a place to keep records of past history and present events.

It's hard to quarrel with the benefits a library can provide to a community and its residents.

By contributing to the Canton library fund, you can help this once-rural community come to grips with its identity in an urban age.

The Community Crier

"THE NEWSPAPER WITH ITS HEART IN THE PLYMOUTH-CANTON COMMUNITY"

572 S. Harvey St. 453-6900
Plymouth, Mich. 48170

RECYCLE NEWSPAPERS

Publisher	Hank Meljer
Editor	Donna Lomas
Advertising Director	Mark Ferraiuolo
Sports Editor	Chas Child
Asst. Sports Editor	Jeff Rey
Photo Editor	Bill Bresler
Editorial Cartoonist	Charlie Yerkes
Advertising Consultants	Fran Hennings, Pat Steele
Production Manager	Mike Carne
Artist	Cynthia Trevino
Circulation & Office Director	Phyllis Redfern
Business Manager	Melanie Robinson
Typesetter	Karen Sanchez

PUBLISHED EACH WEDNESDAY

by Plymouth-Canton Community Crier, Inc.

W. Edward Wendover, President

CARRIER DELIVERED: MAIL DELIVERED:
70 cents monthly; \$8 yearly \$11 yearly in U.S.A.



Twp. girl still critical

An eight-year old Plymouth Township girl remained in guarded condition in the intensive care unit of St. Mary Hospital in Livonia yesterday, nearly a week after she was struck by a car in front of her home on Haggerty Road.

Hospital authorities said they did not know how long the girl, Tammy Bartalsky, would remain in intensive care.

She was struck by a car driven by a 23-year old Garden City woman last Wednesday at dusk. The accident occurred on Haggerty just north of Ann Arbor Trail.

A Plymouth Township woman who was driving the car immediately in front of the one which struck the girl said, "she was running across a front lawn. She stopped on the roadside and then dashed out in front of the car behind me." The driver of the car was not issued a citation.

Must Cantonites have streetlights?

Whether or not to require streetlights in Canton Township has yet to be decided by the Board of Trustees.

The issue of streetlights for the township was discussed by the board last Tuesday as part of the proposed Subdivision Control Ordinance.

Clerk John Flodin also said that the board has to decide how far apart the streetlights should be and when in the course of a subdivision's development the petitions to install them should be initiated.

New! LOW-COST "FACELIFT" FOR OLD KITCHEN CABINETS



- RICH, NEW FORMICA EXTERIOR! Outside surfaces of your cabinets beautified with formica.
- Brand new formica doors and drawer-fronts fitted and installed to your cabinet.
- You save! ... by having cabinets refaced rather than replaced!
- Lifetime guarantee on material and labor.

Cabinet Clad
FACTORY SHOWROOM
OPEN SUNDAYS
25305 John R.
Just N. of 10 Mile
398-7202
19310 Ecorse Rd. Allen Park

GRAND OPENING

THURSDAY-FRIDAY-SATURDAY-NOVEMBER 10th 11th 12th

DON'T MISS IT!



NOTICE: WEBER COOK-OUT... at KEMP'S KORNER'S SATURDAY NOV. 12th A.M. CHICKEN • HAM & TURKEY ON THE HOUSE!

"C'MON IN AND GET ACQUAINTED TO LIVONIA'S BRAND-NEW HARDWARE STORE THAT OFFERS THE MOST MODERN SHOPPING FACILITY MIXED WITH A LARGE SERVING OF OLD-FASHIONED COURTESY & DOWN-HOME SERVICE!"

Meet **MR. BRIC**
BEAUTIFUL-DO IT YOURSELF WALL FACING.. DEMONSTRATION DURING OUR GRAND OPENING



FREE KEYS MADE DURING OUR GRAND OPENING!

FLASHLIGHT reg. \$1.49 2 cell size RAYOVAC **88¢**

CASE CUTLERY (IT'S FAMOUS!) SHEARS ~~was \$5.99~~ **5.99**

SCISSORS ~~VALUES TO \$12.95~~ **5.98** (AS IS-Factory Seconds) your choice ELMERS GLUE - 16 oz. reg. \$2.59 **88¢**

RAYOVAC FLASHLIGHT BATTERIES IC-2-D **23¢**

REG. 39¢

MASKING TAPE 3/4" GOFT ROLL **39¢**

REG. 69¢

WE'RE THE BIGGEST LITTLE HOME SERVICE CENTER IN THIS AREA.

A SMILE COSTS US NOTHING!

CHAINSaws SHARPENED **99¢** reg. 4.95

SEE A McCULLOUGH CHAIN SAW DEMONSTRATION DURING OUR GRAND OPENING!

FREE ROASTED PEANUTS DURING OUR GRAND OPENING!

BASKETBALL HOOP & BACKBOARD **28.88**

CASE CROOKED ROD **DOG BONE** SHARPENS ANY KNIFE YOU HAVE! **2.25**

WE FEATURE A COMPLETE LINE OF GRAHAM'S PAINT (THE BEST!)

1 GALLON GAS CAN **1.08** reg. \$1.69 Includes Spout.

RAYOVAC LANTERN BATTERY reg. \$1.98 **1.49**

MINUTE LAMP KIT reg. \$3.19 **1.99**

ELECTRIC PLASTIC TAPE **44¢** 3/4"-60 FT

GLASS CUTTING • STORM AND SCREEN REPAIRS • PIPE CUTTING & THREADING!

SCREWDRIVERS • PLIERS & RUSTY NAILS... AND A WHOLE LOT MORE!

Nationally Advertised **KINDERGARD LATCHES** Child-proof latches! reg. \$4.59 **3.99** Approved by Parents Magazine!

WITH GAUGE **FIRE EXTINGUISHER** U.I. APPROVED COAST GUARD APPROVED **\$6.88** \$9.95 VALUE

WE STOCK FIREPLACE FIXTURES by Bennet-Ireland

AUTOMATIC CLOSET LIGHT **2.88** reg. 3.95

WE HAVE PABST BLUE RIBBON MALT!

New **GOOD-BYE-DRY** The first easy-to-install central humidifier.

REGULAR \$59.95 VALUE **\$49.88**

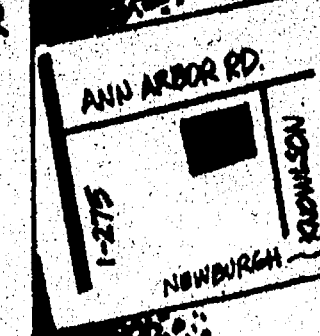

WE'RE EASY TO FIND... 38741 ANN ARBOR Rd. (Between Newburgh & I-275)
HOURS: MON THRU FRI - 8am to 9pm.
SAT: 8AM to 6PM. • SUN: 10AM to 4pm.

OUR MAIN CONCERN IS YOUR RETURN

Kemp's Korner's
HARDWARE & HOME SERVICE CENTER
★ Plenty of Parking
PHONE **464-4121**

Theatre Guild opens season



PLYMOUTH THEATRE GUILD players Christina Opaleski (left) as Ann Miller, Dale Feldpausch as Richard Miller and Clemie Cyburt as Janet Friedman rehearse their parts for the upcoming production of "6 RMS RIV VU" this weekend. (Crier photo by Bill Bresler.)

The Plymouth Theatre opens their 1977 season this weekend with 6 RMS: RIV VU by Bob Randall, a sophisticated comedy, according to Pat Troth of the Theatre Guild.

The play ran on Broadway and has been successfully done by several small theatre groups and was also featured on television.

The play revolves around a couple, both married to different people, who are each looking for an apartment to rent in New York. They find the same apartment and get locked in for a night.

"There are a lot of side twists to it," said Ms. Troth.

The cast includes Clemie Cyburt as producer and Janet Friedman; Blanche Graham, director; Christina Opaleski as Anne Miller; Rons Samuel as Paul Friedman; Ben Dean as superintendent of the apartment; Patricia Bray as the pregnant woman; Robert Fitzgerald as the expectant father; Kathleen O'Mara as the woman in 4A; and Dale Fedlpausch as Richard Miller.

The play will be held Nov. 11, 12 (this weekend) at 8 p.m. at Central Middle School at Main and Church Streets. It will also be presented next weekend, Nov. 18 and 19 at Central at 8 p.m.

Tickets are \$3. Tickets for students and senior citizens are \$2.

Like drama? Guild offers role for you

The Plymouth Theatre Guild will hold its monthly General Meeting on Tuesday, Nov. 15 at 7:30 p.m. in Central Middle School Church St. at Main St. in Plymouth. All persons interested in Guild activities are invited to attend.

Also on Nov. 15 following the General Meeting and Wednesday, Nov. 16 at 7 p.m. in Central Middle School, the Guild will hold auditions for our Childrens show "Tom Sawyer" the musical adaptation by Matt Bond and Dave Barton from Mark Twain's classic story of the young Tom and his adventurous life.

There are twenty-six singing, acting and/or dancing parts. Of those parts there are eight boy, eight girl, five men and five women leads and then ten extra parts for children.

There are also committee openings in publicity, ticket sales, props, costumes, set design and construction, make-up and house preparation.

WSDP plans news show

Wednesday at 7 p.m., follow Mike Schulte's Easy Listening Show on WSDP will air Parameters. Parameters is a biweekly news magazine that focuses on the Plymouth-Canton Community. Leanne Lanphear and Andy Melin are the hosts for the show.

What's happening

OFF TRACK STUDENT ACTIVITIES

The Penn Theater has matinees at 1 p.m. Wednesdays for students whose tracks are on vacation. The Cultural Center at 525 Farmer can also help you plan off c track activities for schools - call them at 455-6220.

PIONEER STUDENT COUNCIL CANDLE SALE

A candle sale will be held by the Pioneer Middle School Student Council to enable them to fund items for the school. The sale will be held until Nov. 15. Parent volunteers are needed to tabulate sales. Call Mr. Bevins at 455-1515 if you wish to volunteer.

HULSING CUB SCOUT PAPER DRIVE

Hulsing Cub Scouts will hold a paper drive from 9 a.m. to noon Sat. Nov. 12. Drop papers off at the school.

"FALL WRAP UP" LUNCHEON

The Christian Women's Club will have a luncheon at the Mayflower Meetinghouse Thursday Nov. 10 from noon to 2 p.m. A soprano soloist, Marjane Baker will be featured and also a lesson in gift wrapping. Nursery and lunch reservations must be made by Nov. 3. Call Dorothy Mowry at 453-4282 or Linda Murphy at 522-5116. A sack lunch must be provided for the nursery set.

GREEN AND WHITE BALL

Among varied fund raising affairs at Fr. Gabriel Richard High in Ann Arbor is the annual Green and White Ball which is to be held this year on Friday evening, Dec. 2, 7 p.m. to midnight at Barton Hills Country Club and will feature an evening of cocktails, dinner, dancing and music. Tickets are \$100.00 per couple with all proceeds going to the academic programs at the school. For ticket information call 663-2236.

PLYMOUTH GOODFELLOWS TO MEET

The Plymouth Goodfellows will hold a meeting Nov. 9 at the Main Street Fire Station at 7:30 p.m. The annual group photo will be taken that evening.

ENGAGED GIRLS HONORED

The Welcome Wagon will host a party to honor engaged girls in the Plymouth Canton area. Decorating, cooking and planning your wedding are topics that will be covered. Refreshments and door prizes will be awarded. Call Maureen Barber at 522-4694 or Dianne Jurick at 427-9707 for more information.

RECITAL AT ST. JOHN'S EPISCOPAL CHURCH

A contralto and an organist will perform at St. John's Episcopal Church at 574 S. Sheldon Road Nov. 13 at 4 p.m. A free will offering will be accepted.

PRESBYTERIAN PROGRESSIVE DINNER DANCE

First United Church will host a dinner dance Sat. Dec. 10. Appetizers will be at member's homes and dinner will be served at 8:30 p.m. in the church. Dancing beginning at 9:30 p.m. Cost is \$15 per couple and all members, prospective members and guests are invited. Reservations plus check to Linda Lulce by Dec. 1. Call 455-0863.

TWINS CLUB MEETS

The Western Wayne County Mothers of Twins Club will hold their regular monthly meeting at 8 p.m. on Monday Nov. 21, at Holy Cross Evangelical Lutheran Church, 30650 Six Mile Rd., Livonia. Any woman who has had a multiple birth is invited to attend. For further information regarding the club and its activities, please contact Mrs. Lynn Lyon 44624 Oregon Trail 455-0137. The club is also registered with the Chamber of Commerce.

SOLO ART EXHIBIT

Plymouth artist Johnnie Crosby will feature a water color and wall sculpture art exhibit in Ann Arbor through Nov. 23 Monday through Friday 9 a.m. to 4:30 p.m. at 2101 Bonisteel Blvd.

OLGC FEATHER PARTY

The third annual feather party of the Altar Society of Our Lady of Good Counsel Church will be Nov. 17 in the school gym. No one under 18 will be admitted.

ST. KENNETH SENIORS MEET

The senior citizens of St. Kenneth's will meet Nov. 15 at noon, bring a bag lunch, coffee and dessert are furnished. Bingo after meeting, bring a useable white elephant. All are welcome.

PLYMOUTH GARDEN CLUB MEETS

Plymouth Garden Club will hold a workshop Nov. 14, 9:30 a.m. to make perforated paper marks in the home of Mrs. Richard Mallow.

METHODIST WOMEN'S ARTS BOUTIQUE

United Methodist Women sponsor annually an arts and crafts boutique as a money making project to help fulfill the mission pledge of the United Methodist Women. This year's boutique will feature dried flowers, ceramics, candles, stuffed toys, and other handcrafted items. Friday, Nov. 11, from 9:30 a.m. to 5 p.m. in the Fellowship Hall at the First United Methodist Church at 45201 N. Territorial, Plymouth, MI 48170. Babysitting will be available. Coffee and donuts may be purchased before lunch. There will also be a bake sale all day. A luncheon will be served starting at 11:30 a.m.

PLYMOUTH REGISTERED NURSES

The PRN's will meet Nov. 14, the second Monday of the month to tour the new St. Joseph's Hospital, in Ann Arbor at 7 p.m. We will be meeting in the township parking lot to form car pools at 6:15 p.m. All will meet in hospital lobby at 7 p.m. There will be a short business meeting after the tour.

IN THE OLD VILLAGE
ITS
Bill's Market
584 STARKWEATHER
PLYMOUTH - 453-5040
GROCERIES—MEATS BEER & WINE
TO TAKE OUT • PARTY SNACKS
SANDWICHES • DELICATESSEN

STILL TIME TO...

Make your home beautiful for the holidays

WALLPAPER SPECIALS

10% off Special orders 3 rolls or more

15% off All Stock Wallpaper

Give that special someone you love one of the accent pieces that make a home so specially yours...

- Unfinished furniture
- Whiteware
- Mirrors-clocks
- Gift certificates

from:
PEASE PAINT & WALLPAPER CO
70 MAIN STREET, PLYMOUTH

Winter Hours:
Mon-Fri 9-9 PM; Sat 9-6 PM

453-5100

What's happening

ORGAN RECITAL

A University of Michigan graduate student will give a free organ recital at St. John's Provincial Seminary in Plymouth Sunday, Nov. 13. The recital, begins at 7 p.m. and will be in the seminary chapel and will be performed by Curtis Posuniak, a candidate for a Master's degree in music at the University in Ann Arbor.

M.A.C.L.D. MEETS NOV. 16

The Plymouth-Canton-Northville Chapter of the Michigan Association for Children with Learning Disabilities is proud to present as guest speaker, Dr. James A. Sonnega, at its third meeting, held at 7:30 p.m., Nov. 16, in Pioneer Middle School's cafeteria. The topic for discussion will be "Learning Society and The Disadvantaged Learner." The general public is invited.

SACKETT CHAPTER DAR MEETS

The John Sackett Chapter DAR will hold its November meeting on Saturday, Nov. 12 at noon. It will be the chapter's thirty-sixth Birthday Luncheon at the Meadowbrook Country Club, 40941 Eight Mile Road, Northville. The Program coordinator is Mrs. Edwin Mudie, Dearborn. As a fund raising project, members are asked to bring in homemade articles, including food items, to be sold, putting a price on each item. Mrs. Bill Franklin Sheets State Director, and other State Board members will be attending the luncheon. Several regents of neighboring chapters have been invited.

ALPHA OMICRON PI MEETS

The Northwest Suburban Alumnae Chapter of Alpha Omicron Pi Sorority will meet Thursday, Nov. 10 at 7:30 p.m. at the home of Mrs. Rex Spencer, 2220 Connemara Drive, Northville.

LIVING WELL IN LATER YEARS

Schoolcraft College will offer a four-part Senior Forum entitled "Living Well in the Later Years" during November and December. The Forum is scheduled from 1:30 to 3 p.m. Nov. 15, 22, 29 and Dec. 6 at the Garden City Parks and Recreation Log Cabin. It will provide seniors an opportunity to take a second look at resources and experiences from their own homes and communities. Senior Forum is a continuing series of community based discussion groups on issues of retirement living. Further information may be obtained by calling 591-6400, extension 218.

LA LECHE LEAGUE MEETS

The third in a series of four meetings on breastfeeding techniques will be held at 8 p.m. Wednesday, Nov. 16, in the home of Joan Klaas, 15439 Susanna Circle, Livonia. The series is sponsored by the Plymouth-Northville La Leche League, and the Wednesday session will deal with the arrival of the baby. For information and telephone help, call leader Charlene Frellick, 349-2840. A new morning series of the league is beginning led by Millie Conway, 455-6115, and Kay Williams, 455-1840, and will be in its second meeting on Dec. 6, to be held at 9:30 a.m. in the home of Laurel Jeris, 6167 Porteridge, Canton Township.

GALLIMORE BOOK FAIR

Gallimore elementary school will hold a Book Fair on Nov. 16, 17, 18, 21, 22 in the school's media center. The hours will be from 9 a.m. until 4 p.m. on Nov. 16 and from 9 a.m. until 7 p.m. on the remaining days. Books will be available offering parents an opportunity to do some early Christmas shopping. In addition to a wide selection of paperback books there will be coloring books, crayons, animal posters, flash cards and magic slates.

LWV WINE AND CHEESE PARTY

The League of Women Voters of Canton, Plymouth and Northville, Novi will host an Open House Wine and Cheese Party at the home of Mr. and Mrs. Dulmont in Northville, Friday, Nov. 11 from 8 to 10 p.m. Proceeds will go towards LWV projects, \$7 minimum donation per couple. Please RSVP by Nov. 9 to Lois Hoffmeister, 348-1016. (Please bring your own wine glasses).

ACRYLIC PAINTING CLASS

An advanced acrylic painting class will begin on Monday, Nov. 21 from 7:30 p.m. at the Plymouth Cultural Center. Another beginners acrylic painting class will start on Wednesday, Nov. 23 from 7:30 p.m. No background in art of painting is required. Learn to paint and create your own pictures each meeting. For more information contact the Plymouth Recreation Department at 455-6620.

CHRISTMAS ARTS & CRAFTS SHOW REGISTRATION

Registration for the Fourth Annual Plymouth Christmas Arts and Crafts Show is now limited to booth space in the cafeteria of Central Middle School. Booth space is available for Saturday, Dec. 10 from 11 a.m. to 9 p.m. You may register at the Plymouth Cultural Center. Booth space is \$12 for Saturday. For more information about this Plymouth Recreation Department sponsored activity phone 455-6620.

ICE SKATING REGISTRATION

Registration for beginners for Session II of Fall Figure Skating lessons will be held on Friday, Nov. 11 from 2:30 to 5:00 p.m. and on Saturday, Nov. 12 from 8:30 a.m. to 4:30 p.m. Session II begins on Monday, Nov. 14. There will be a one week break during Thanksgiving and a two week break during the Christmas Holidays. The lessons run for 8 weeks in 25 minute sessions. The fees are \$12 for residents and \$16 for nonresidents and \$1 less for more than one in the same family. A resident in anyone who lives within the Plymouth Community School District.

Volunteer CB'ers seek members

A volunteer team called REACT that monitors CB emergency channel 9 is holding a membership meeting Nov. 19 at the American Legion Hall on Sheldon Road at Goldsmith in Plymouth at 1 p.m.

"We are interested in meeting serious-minded people who would like to join us in serving the communities of Canton, Plymouth and Northville," said Harold Jacobs, membership drive chairman.

The requirements for membership include: 1) 16 years of age or older; 2) must be willing to monitor at least three hours every other week-end; 3) must have a sincere interest in serving the public good; 4) must be willing to abide by the FCC rules and regulations governing CB use.

The local REACT team cooperates with all law enforcement agencies and disaster preparedness groups, a REACT press release said. The group monitors channel 9 from the Northville Township Police Station.

Plymouth Chamber hosts dinner

Some 150 members of the local business community gathered in Waterman Center on the Schoolcraft College campus last Wednesday night for the 1977 annual meeting of the Plymouth Community Chamber of Commerce.

Following welcoming remarks by Schoolcraft President Nelson Grote and an invocation by The Rev. Henry Walsh, chambers members heard an address on legislative activities affecting small business by Rep. Carl Pursell (R-Plymouth), who flew in from Washington D.C. shortly before the event began.

Outgoing chamber committee chairmen Joan Gerick and Tex Thoman were commended by their colleagues, and Jerry Loisell presented an update on chamber plans for a new community map.

Chamber Executive Secretary Chris Kresta noted that during the last year, some 30 new businesses have opened in the City of Plymouth.



OLD VILLAGE ASSOCIATION. President Doug Montgomery was presented this certificate for new business growth and beauty in Old Village by Chamber of Commerce President Margaret Wilson and Tex Thoman at the Chamber annual dinner recently. (Staff photo.)

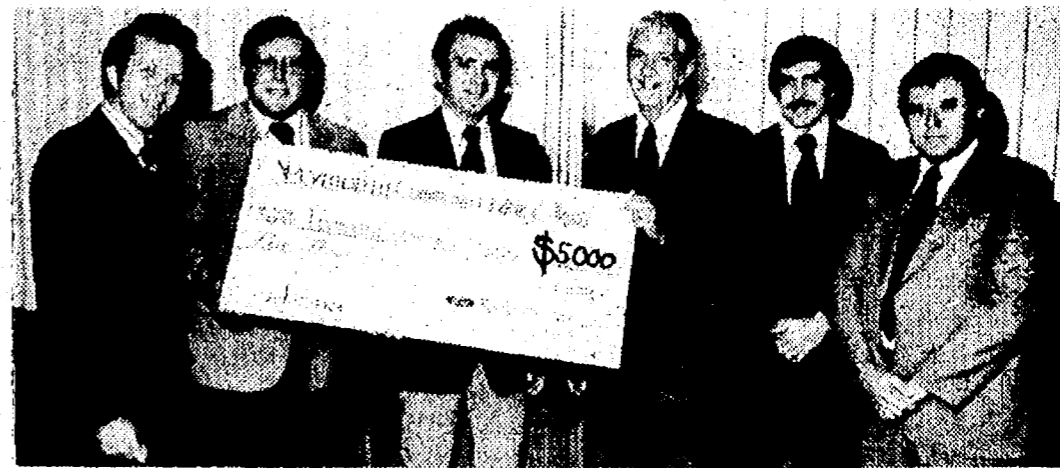

PCF nearing goal

PLYMOUTH COMMUNITY FUND received a check for \$5,000 from Ford Motor Company last week. Pictured here are (left to right) John Czuba, industrial division chairman; Dan LeBlond, general chairman for PCF; John Hargrave, industrial division co-chairman; Gary Schoettley, Ford plant manager; Jerry Colaner, salaried personnel manager; and Gene Burkhardt, industrial relations manager. The Fund has reached 34.3 per cent of its goal, \$85,800 said Bill Carlson, public relations chairman for the PCF. Carlson said the amount was a "little ahead of last year at the same time." (Crier photo by Bill Bresler.)

PG. 6 THE COMMUNITY CRIER: November 9, 1977

The Cutting Quarters



INTRODUCING

* Henna treatments
* Body waves & naturals
for the men & women of today
CALL FOR RESERVATIONS

459-0640

Good Parking Available **328 South Harvey**



RESTAURANT

Thanksgiving Day Dinner

November 24, Noon to 7PM

Served Family Style...

All You Can Eat

Turkey, Ham, Chicken, Candied Yams,
Cranberries, Pumpkin Pie
and much more.

Complete Dinner Including
Salad Bar, Coffee, Milk or Pop



Adults **\$8.95**

Children under 12 **\$4.95**

2 and under - no charge

Advance Reservations Suggested

NAPOLEON'S MAIN STREET SO. OF ANN ARBOR TRAIL 459-6370

Flask collection reveals colorful hobby

BY DONNA LOMAS

What do the Chicago Fire, a Barnum and Baily Circus, the Alaskan purchase, the International Chili Society and Mortimer Snerd have in common?

Those and dozens of other collector's bottles are housed in retired Plymouth Police Lieutenant William Guldner's basement, part of a collection of Jim Beam whiskey bottles that he started nine years ago.

"My brother-in-law got me started on it," said Guldner, who doesn't drink because of health reasons. "It was about nine years ago. He lived up north and had me look for Beam bottles because there was more variety in stores down here."

Guldner's collection now overflows from his basement to above the kitchen cupboards and into the living room.

It actually looks as if the Guldner's (Esther Guldner, a nurse, is the secretary for the International Association of Jim

Beam Society in this area) home is a showcase for fine china figurines.

The displays depict military men, outdoor life, historical American scenes and delicate miniatures that detail a hawk in flight or a mother duck with her ducklings.

Themes range from 100 years in American baseball to Boot Hill. Other bottles depict Bonny and Clyde, a geisha from the opera "The Mikado", pairs of Model T cars, wildlife and past World Fair locations and sites of the Republican and Democratic National Conventions.

Sometimes mistakes are made. In 1972, a mold was made for the Republican Convention which the bottlemakers thought would be in San Diego, Calif. The convention was held in Miami, but the mold had been set and it was too late to change it.

A flask commemorating King Kong was issued earlier this

year. One flask was even shown on television for years as a genie bottle.

Guldner says the bottles are made in molds and handpainted. He even has a series of bottles painted in 22 carat gold called the "executive series" that is issued once a year at Christmas.

The whiskey in the porcelain flasks is aged more than 100 months and some of the limited edition Beam bottles are worth hundreds of dollars, said Guldner.

"It's an investment, sure," he said. "But I don't collect bottles just because they're Jim Beam. I collect them because I like them. I have bottles from other companies, too. But I like Beam the best."

Bill and Esther Guldner belong to the Great Lakes Jim Beam Bottles Club and they meet every last Thursday of each month at the Local 182 Hall on Plymouth Road. They welcome anyone who would like to attend.

Guldner's Beam collection is nearly complete. He and his wife, Esther, are members of the Jim Beam Association because they enjoy collecting and because it is a social club, too.



PLYMOUTHITE and former City Police Lt. William Guldner shows one of his many bottles from a nine-year bottle collection. (Crier photo by Bill Bresler.)

"It is a non-profit club," Guldner said. "And the royalties on these bottles go towards a charity or a cultural or non-profit group."

"Right now, our club is trying to pick a local charity

we can start to give to. The life-long Plymouth resident noted, "It's whatever a person makes it," his eyes sweeping the basement full of more than 500 bottles. "It's quite a hobby."

the print shop

is open at the Old Village Gallery

383 STARKWEATHER, Plymouth 459-4170

original prints—fine inexpensive reproductions—limited editions—perfect for your new picture grouping—framed & unframed—in color & black and white.

Poole named

James Poole of S. Umland Circle in Canton was named by Gov. William Milliken to the Emergency Preparedness Advisory Council.

Poole is a retired United Air Force Major and former Canton township trustee and a former member of the Canton Township Recreation Advisory Committee.



Overholt tapped

PLYMOUTHITE GENE OVERHOLT of 41202 Marlin was recently elected Governor of the Michigan District of Kiwanis International at the Kiwanis State Convention at the Grand Hotel on Mackinac Island. He will serve as District Governor until Oct. 1978. Overholt is a charter member of the Kiwanis Club of Colonial Plymouth and was president in 1970-71, and Distinguished Lt. Governor of Division 9 of Kiwanis in 1973 and 1974.

Just ANN'S Wallpaper & FABRIC

746 Starkweather 459-5444

the Crier's friends & neighbors

PCAC receives grant

The Plymouth Community Arts Council has received a \$1,000 grant from the Michigan Council for the Arts.

The grant was announced by Representative Roy Smith, whose district includes Plymouth. Smith announced the funds will be matched locally and will be used to sponsor performances by a professional children's theatre company in 10 elementary schools in Plymouth-Canton in January.

The funds are part of an "ongoing community arts program" sponsored by the Michigan Council for the Arts, a state agency which derives its financial support from the State Legislature, the National Endowment for the Arts and private contributions, said Smith.

Phase III on display

Music and athletic facilities in the new Phase III section of Canton High School will be on public display Monday, Nov. 14, from 6:30 p.m. to 8:30 p.m. Although the newest wing of the high school complex has been in use since last February, this is the first open house held there, say the schools.

Tours of the building will be conducted by high school students. Demonstrations of learning activities will take place in all areas.

Swimming, wrestling, gymnastics, volleyball, basketball, and racquetball will be in full swing. Both vocal music and instrumental music performances are planned.

Phase III was constructed at a cost of \$3,900,682 from funds raised through a bond issue passed by the voters on March 26, 1974.

CEP provides space for approximately 4,000 students. The high schools now house 4,200 students with an anticipated enrollment next year of 4,500.

PAIR UP WITH PEDWIN

your basic sensational shoes - today's casual looks and comfort

"BREED" \$30

Brown Smooth Uppers

MEN'S MEDIUM WIDTH Sizes 7-11 1/2

Instant Charges To Your BankAmericard or Master Charge - Call 543-1390

Fisher Shoes

290 SOUTH MAIN/PLYMOUTH

Stories woven in fabric

Gallimore elementary school students can see children's books come to life in a new art form in their media center: fabric collages.

The display, created by a group of women artists known as the "Needlethreaders," is entitled "Fabric Fantasy from Children's Books."

Each colorful fabric collage is a replica of a page from a familiar children's book. Among the books represented are: "Zoophabets" by Robert Tallon, "A Pocketful of Crickets" by Evaline Ness and "Dogs Don't Belong on Beds" by Enid Blome. The books are on

display with the wall hangings.

The exhibit, which has been displayed at the Dunning-Hough library, will remain at Gallimore through November.

"The Needlethreaders," meet weekly for instruction but the major part of the work is done by individual members at home.

The first series of wall hangings was completed in 1973 by the artists and widely circulated in public and school libraries in the metropolitan area. The exhibit at Gallimore is a combination of the original 1973 show and another show completed in 1975. A third "Fabric Fantasy from Children's

Books" is almost completed.

In addition to children's themes, the group has prepared shows featuring costumes, religion, Christmas cards and Americana. The Americana exhibit was on display at the Dunning-Hough library during the bicentennial year.

"The biggest reward for the group is to know that through this work of making pages from children's books come alive, many young people are stimulated to read those and other books and eventually to gain a love of reading," said Dorothy Harwood, leader for the "Needlethreaders."



GALLIMORE STUDENTS Emily Barr (left) and Lisa Eby chat in the Gallimore media center under fabric collages with teacher. (Crier photo by Bill Bresler.)

Penniman Johnnie loosens apron strings



JOHNNIE ROGIN

When Johnny Rogin decides its time for a change in his life, he changes it.

His life for the past 23 years has been entwined with the life of his Penniman Market in Plymouth on Penniman Street -- until this month.

"That's when an opportunity came along for me and I sold my market to two young fellows," he said. "It's a turning point for me, an opportunity to take it a little easier instead of working 60 to 80 hours a week."

The two young men, Brian Devlin, 20, and Russ Webster, 20, said they plan to run the market much the same way Rogin has: with a taste of the homemade and a touch of hometown courtesy.

"People (cliente) don't come that easy," said the

white-aproned Johnny in the back room of his former market, "When I bought this place they said I wouldn't last for six months."

At that time, almost 40 years ago, Rogin said there were five meat markets and grocery stores on Penniman between Harvey and Main streets.

Rogin said he worked for the Purity Meat Market at the corner of Ann Arbor Trail and Main, worked for another market on Penniman before working for Smith's Market on Penniman. That was changed to the National Food Company and a few years later, Rogin bought the store in 1954.

"The homemade is important," Rogin said. "The way the customer wants it is the success of the business definitely."

Chatting in the back room of the market, where a pot of soup bubbled on a stove and bills and adding machine tape

threatened to overflow from a small alcove office, Rogin reminisced about his years as owner.

"Before the high school moved out, students used to line up in here for lunch every day," he said. "We catered

completely to the customer."

Rogin says he will still work -- only 50 or so hours a week now he says -- but not at the market.

"It's a turning point for me," he said.



RESTAURANT & GAZEBO ROOM

FASHION SHOW

Wednesday, November 16th
10 PM

**555 FOREST
PHONE 459-6370**



Freiman awarded

JUDITH E. FREIMAN has won the Century III Leaders Scholarship competition at Canton High School, according to Kent Buikema, principal. The 17-year-old senior is now eligible to compete with other high school seniors throughout Michigan for one of two \$1,000 scholarships and also for a \$10,000 national scholarship that will be awarded in a conference of state winners in historic Colonial Williamsburg, Va. Freiman scored highest at the school in a current events examination and the writing of a brief essay on America's needs and challenges for the future.



JUDY FREIMAN

TOWARD A MORE NATURAL YOU... Nutritional Programming

10% OFF ON ALL PRODUCTS WITH THIS AD



friends of nature
health food center
459-5433

5924 harvard square plaza - ford at sheldon

IDEAL ALLEGHENY PATCHWORK WAVERLY NORMAN OF SALSBURY

THE BEDSPREAD PLACE

(Factory Outlet) **40% to 70% OFF**

On In Stock Spreads
Custom Spreads & Draperies
20% OFF

JUST ARRIVED!!

BEAU IDEAL SPREADS

Originally \$85 to \$150

NOW \$39⁹⁹ to \$53⁹⁹

Full, Queen and King Only

DEARBORN
2235 S. Telegraph
2 blks. south of
Michigan Ave.
561-6464

ROCHESTER
425 Walnut Blvd.
652-4540

341 E. MAIN, NORTHVILLE-
349-0030
Open Mon-Sat 9:30 to 5:30

For your Florida Condominiums, See our outlets in Naples & Cape Coral

WAVERLY BLOOMCRAFT INDIA INK NETTLE CREEK PATCHWORK

Soup, sandwich entice young eaters

NOV. 14 TO NOV. 18
ALL LUNCHES WITH MILK
All Elementary School Lunches
are \$.55 per each lunch.

ALLEN MONDAY
Chicken soup, peanut butter & jelly sandwich, fruit cup, peanut butter bar.

TUESDAY
Hamburger on a bun, relishes, french fries, fruit cup.

WEDNESDAY
Tacos, meat cheese & lettuce, vegetables, bread & butter, fruit cup, chocolate pudding.

THURSDAY
Hot dog on a bun, relishes, vegetables, fruit cup, dessert.

FRIDAY
Pizza, sausage & cheese, vegetable, fruit cup.

BIRD MONDAY
Toasted cheese sandwich, tomato soup, fruit cup, toll house bar.

TUESDAY
Ravioli, buttered bread, buttered vegetables, chocolate pudding.

WEDNESDAY
Thanksgiving Dinner, mashed potatoes, buttered hot roll, fruit cup, Thanksgiving cake.

THURSDAY
Hot dog on a bun, hot vegetable, fruit cup, dessert.

FRIDAY
Fish sticks, tartar sauce, catsup, french bread, buttered vegetable.

ERIKSSON MONDAY
Tomato soup, toasted cheese sandwich, fruit cup, toll bar.

TUESDAY
Hamburger gravy, mashed potatoes, hot roll, fruit cup.

WEDNESDAY
Pizza with meat and cheese, tossed salad, fruit cup, cookie.

THURSDAY
Hot dog in bun, relishes, vegetable, fruit cup, cake.

FRIDAY
Oven fried chicken, mashed potatoes, bread & butter, fruited gelatin.

FARRAND MONDAY
Submarine sandwich, buttered vegetables, fruit crisp.

TUESDAY
Tacos, buttered vegetables, cake, fruit.

WEDNESDAY
"THANKSGIVING DINNER"
Sliced turkey, mashed potatoes, gravy, hot rolls, cranberry sauce, green vegetables, jello w/fruit, cake.

THURSDAY
Hot dog on bun, mustard or catsup, buttered vegetables, cookie, apple sauce.

FRIDAY
Fish Sandwich, Buttered vegetables, cake, fruit.

FIEGEL MONDAY
Chicken vegetable soup, peanut butter & jelly sandwich, fruit, cheese stix.

TUESDAY
Hot dog on bun, mustard, catsup, carrots or sauerkraut, fruit, brownie.

WEDNESDAY
Ravioli in meat sauce, vegetables, hot rolls, fruit.

THURSDAY
Thanksgiving Lunch
Sliced turkey, mashed potatoes with gravy, cranberry sauce, buttered warm bread, jello with fruit, Thanksgiving cake.

FRIDAY
Grilled cheese sandwich, pickle slices, vegetables, fruit, mixed peanut cup.

FIELD MONDAY
Grilled cheese sandwich, tomato soup, crackers, fruit.

TUESDAY
HOT DOG DAY

WEDNESDAY
Sloppy joe on bun, hash browns, fruit.

THURSDAY
Thanksgiving Dinner
Turkey, potatoes, gravy, cranberries, peas, dinner rolls, butter, pumpkin pie.

FRIDAY
Hamburger on bun, pickles, potato sticks, vegetable, fruit.

GALLIMORE MONDAY
Chicken gumbo soup, peanut butter sandwich, fruit, cake.

TUESDAY
Barbecue beef o/bun, buttered green beans, fruit, peanuts.

WEDNESDAY
Roast turkey w/gravy, mashed potatoes, hot rolls, cranberry sauce, pumpkin pie, fruit salad.

THURSDAY
Hot dogs on bun, mustard or catsup, buttered corn, apple strudel.

FRIDAY
Pizza w/cheese & meat, buttered wax beans, fruit, cake.

HULSING MONDAY
Hamburger and roll, relishes, french fries, applesauce, pudding.

TUESDAY
Deluxe grilled cheese sandwich, buttered green beans, frosted chocolate cake, chilled pears.

WEDNESDAY
Pizza w/meat & cheese, whole kernel corn, chocolate chip cookie, pineapple chunks.

THURSDAY
Hot dog on roll, relishes, tater tots, gelatin fruit cup.

FRIDAY
Oven baked chicken, mashed potatoes, chocolate chip cookie, fruit delight cup.

ISBISTER MONDAY
Chicken noodle soup, crackers, peanutbutter sandwich, pears, cookie.

TUESDAY
Hamburger on bun, pickle slices, corn, potato chips, fruit cup.

WEDNESDAY
Oven fried chicken, mashed potatoes, gravy, cranberries, buttered roll, fruited gelatin.

THURSDAY
Hot dog on bun, buttered beets, peaches, cake.

FRIDAY
Hamburger & noodle casserole, buttered bread, green beans, orange juice, tollhouse bar.

MILLER MONDAY
Sloppy joe, buttered corn, fruit cup, cookie.

TUESDAY
Steamed frankfurters on roll, tater tots, fruit cup, cookie.



It's that time of the year to count our blessings and be thankful for the food placed on our tables. This week the students can pause a few minutes and give thanks to the cooks for the Thanksgiving Lunch offered in most of the schools. Turkey and all the trimmings, down to the pumpkin pie with whipped cream - sounds mighty good!

It's often been said that the cooks make use of everything, including leftovers to prepare the school lunches. If it can be served for a main dish then it can certainly be used in a casserole or a dessert. I hope Friday's T.G.I.F. Cake at West Middle is not a good example of this.

Is it possible that T.G.I.F. Cake stands for Turkey's Good In Friday's Cake?

WEDNESDAY
Ravioli w/meat sauce, cheese sticks, tossed salad, bread, butter, fruit cup.

THURSDAY
Thanksgiving Dinner
Sliced turkey & gravy, mashed potatoes or candied sweet potatoes, bread stuffing, chocolate cake.

FRIDAY
Batter fried fish, french fries, cole slaw, bread, butter.

SMITH MONDAY
Hamburger on bun, mustard, catsup, peas, cookie, applesauce.

TUESDAY
Fried Chicken, mashed potatoes & gravy, hot roll and jelly, peaches, toll house bar.

WEDNESDAY
No school - p.m. only.

THURSDAY
Hot dog on bun, mustard, catsup or relish, french fries, jello with fruit.

FRIDAY
Pizza, meat & cheese sauce, corn, peaches, cookie.

STARKWEATHER MONDAY
Fishwich, tater tots, fruit cup, cake.

TUESDAY
Toasted cheese sandwich, wax beans, fruit cup, cake.

WEDNESDAY
Spaghetti with meat sauce, buttered bread, fruit cup, cookie.

THURSDAY
Peanut butter sandwich, vegetable soup, fruit cup, cookie.

FRIDAY
Thanksgiving Dinner
Turkey, potatoes & gravy, cranberry sauce, dessert.

TANGER MONDAY
Submarine sandwich, soup of the day, chilled fruit, dessert.

TUESDAY
Chili, hot roll, jello with fruit, cheese stix.

WEDNESDAY
Chicken gravy with whipped potatoes, green beans, bread stix, juice surprise.

THURSDAY
Hot dog on a bun, choice of relishes, french fries, cake.

FRIDAY
Pizza, hot corn, chilled peas, cookie.

CENTRAL MIDDLE MONDAY
Chili with crackers, peanut butter sandwich, fruit cup.

TUESDAY
Hot dog on bun, buttered corn, fruit cup, cake.

WEDNESDAY
Pizza, vegetable, fruit.

THURSDAY
Hamburger on bun, pickle slices, green beans, pineapple slice.

FRIDAY
Fish sandwich, oven fries, tartar sauce, peaches.

EAST MIDDLE MONDAY
Hot dog on bun, relishes, mixed vegetables, fruit or pudding, chocolate chip cookie.

TUESDAY
Chili, grilled cheese sandwich, fruit.

WEDNESDAY
Pizza with meat and cheese, green beans, apple crunch.

THURSDAY
Hamburger on bun, relishes, french fries, fruit, toll house bar.

FRIDAY
Turkey, gravy, mashed potatoes, candied sweet potatoes, cranberries, rolls, butter, pumpkin pie.

PIONEER MIDDLE MONDAY
Hot chicken sandwich on bun, mashed potatoes, gravy, buttered peas & carrots, cranberry sauce.

TUESDAY
Hot dog on homemade roll or chicken patty sandwich, tri-taters, choice of fruit, cookie.

WEDNESDAY
Turkey o/dressing, mashed potatoes, gravy, mixed vegetables, roll, butter, cranberry sauce, pumpkin pie or apple pie, served w/whipped cream.

THURSDAY
Pizza w/meat & cheese, orange juice, buttered corn, jello w/whipped cream, cookie.

FRIDAY
Hamburgers or cheeseburgers, or peanutbutter & jelly sandwich, potato chips, fruit, cookie.

WEST MIDDLE MONDAY
Sloppy joe, whole kernel corn, choice of fruit, peanut butter crinkles.

TUESDAY
Spaghetti with meat, green beans, choice of puddings.

WEDNESDAY
Thanksgiving Dinner
Sliced turkey, mashed potatoes, cranberries, tossed salad, hot rolls, pumpkin pie with whipped cream.

THURSDAY
Hamburger with trimmings, oven fries, choice of fruit or juice, banana cake.

FRIDAY
Submarine sandwich, french fries, applesauce, T.G.I.F. cake.

SALEM-CANTON HIGH MONDAY
Hot beef on bun, potatoes, gravy, vegetable, jello.

TUESDAY
Hamburger or cheeseburgers, or chicken patty on bun, vegetable, potato chips, pickles, fruit.

WEDNESDAY
Goulash or Macaroni & cheese, salad, hot roll, butter, jello.

THURSDAY
Pizza, orange juice, vegetable, peanuts, dessert w/fruit.

FRIDAY
Fish fillets, hash browns, bread, butter, vegetable, jello.

Laurel FURNITURE DESKS

ALL STYLES AND FINISHES

584 W. ANN ARBOR TR. PLY
Open Daily 9:30-6 P.M.
Thurs - Fri. til 9 P.M.
453-4700

Thursday is money saver day

Save 48¢

*3 pieces chicken *Cole slaw
*Mashed potatoes *Hot biscuits
and gravy REG \$1.97

THURSDAY \$1.49

Bucket \$6.99

*15 pieces, gravy (pint)
*6 Hot biscuits

Barrel \$8.75

*21 pieces of chicken

Hot Chili
Back again -- our own hot chili

Grandma's Take Home Famous Recipe FRIED CHICKEN

1122 ANN ARBOR ROAD
(next to Beyer Drugs) Plymouth

453-6767
Proprietor Joe LangKabel



Special Pull-Out Section

BASKETBALL!

Tip-off on the Local Scene

When it comes to insurance



Nancy Hanna
Russ Hoisington
Bev Hoisington
Edith Scherer
Ann Taylor Werner

two agencies

are better than one.



Ken Burcaw
Matt Fortney
Betty Lamphear
Jeanette Schryer
Marlene Shott

Especially when the two companies have more than a century of experience between them. And especially when they are Fisher Wingard & Fortney, and the Finlan Insurance Agency.

When two firms such as these become one, YOU benefit. You receive a greater selection of insurance, more efficient service and the kind of personal attention that seems lost these days.

The Finlan agency opened in 1916. Russ and Bev Hoisington purchased the firm this year from Chuck Finlan, the former owner who now lives in Arizona.

Matt Fortney has been with the Fisher-Wingard-Fortney Agency since 1951. This agency opened in 1936 as the Roy Fisher Agency and merged in 1962 with the Wingard Agency.

The people pictured here are excited about the recent marriage of these two long-time Plymouth agencies and are looking forward to serving you and combining modern technology with old-fashioned concern.

Fisher Wingard Fortney will now be located at the Finlan Agency
Where the two offices will be consolidated.

C.L. FINLAN & SON INC.
FISHER WINGARD FORTNEY AGENCY INC.

500 S. MAIN STREET, PLYMOUTH
(1/2 Block S. of the Mayflower Hotel)
8:30 - 5p.m. Mon. thru Fri.

453-6000

453-4990



Returning aces help Rock cagers aim high

BY CHAS CHILD

Winners of four straight Suburban Eight championships, Salem will be shooting for its fifth with a very strong weapon: versatility.

The Rocks will be so balanced and deep that Coach Fred Thomann said he may have no set line-up. "With so much experience and with the nature of our team, we have many possibilities. We will be able to adjust our game to the weaknesses and strengths of all our opponents."

The solid list of returnees who saw starting action last year goes like this: Rich Hewlett, Doug Agnew, Mike Christie, Tom Ellinghausen and John Broderick.

Ellinghausen at 6'5" was the leading scorer and leading rebounder last year. He was also first-team all-Suburban Eight. "He's got excellent basketball savvy and he's an excellent college prospect," Thomann said.

Hewlett was a second team all-leaguer last year. The 6-foot-guard "penetrates well and plays good defense. He's a great athlete," his coach said.

Thomann will be relying on Christie to continue his excellent outside shooting from his guard position. "He's got great quickness and is an excellent one-on-one offensive player."

Court sense is Agnew's forte, Thomann said. "He's a super defensive player and extremely competitive."

The number of experienced cagers doesn't stop here, however.

The Rocks also have 6'6" Senior Steve Horton coming back from last year. "He's starting to rebound with authority," Thomann said. "He's a good shooter and extremely smart on the court."

Senior Bob Hissom at 6'3½" will also be back. "A good inside player," according to his coach.

"Deceptively quick" David Monk will also see a lot of action this year, as well as Matt Etienne. "Matt's an extremely good ballhandler and he'll surprise you with his outside shooting," Thomann said.

"Over all, the team is extremely competitive and smart as a group. They

Cont. on pg. 19

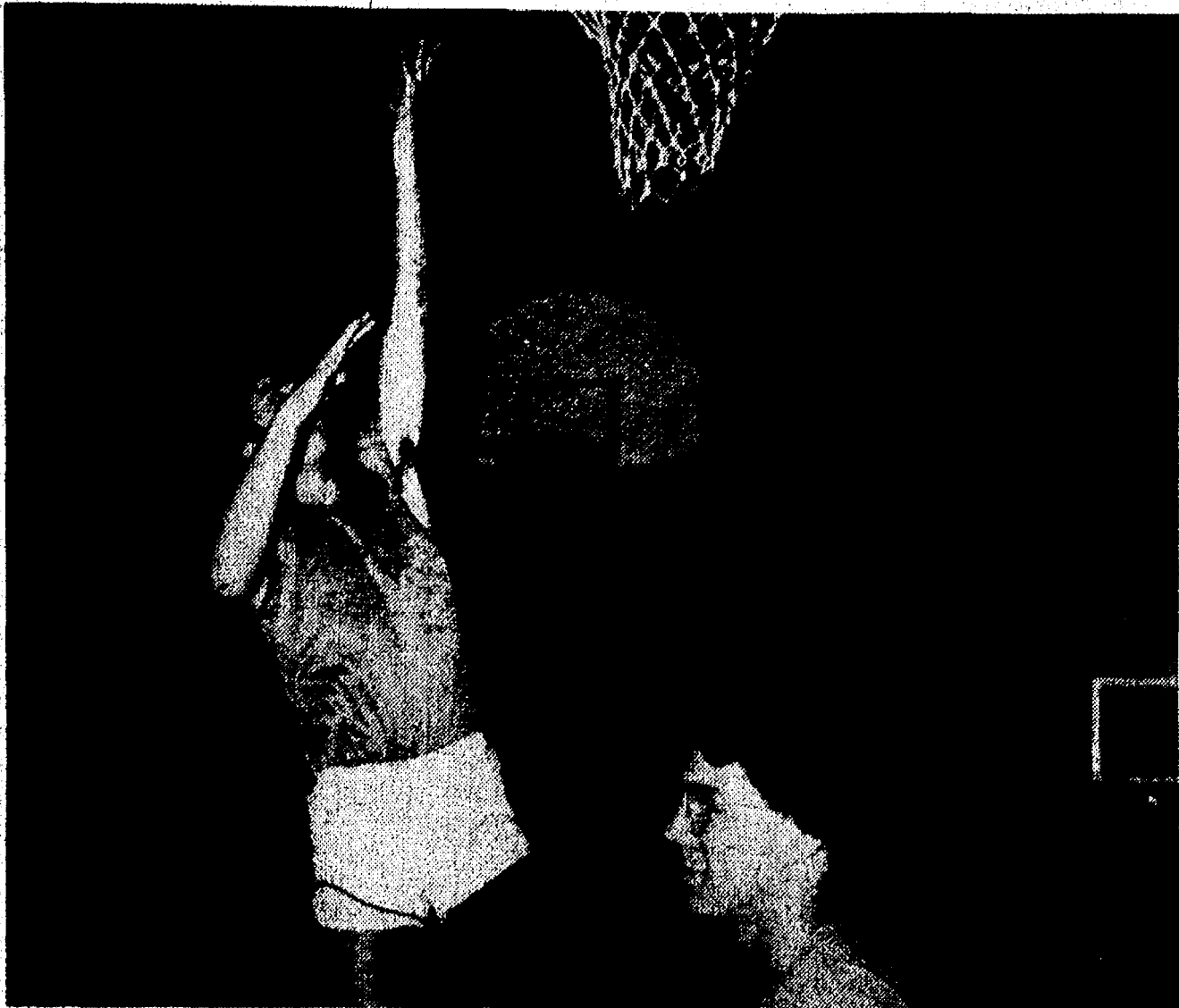

ROCKS WARMING UP in preseason drills.



FRED THOMANN, Salem's Coach, studies his team last season. Thomann has lead the Rocks to four Straight Suburban Eight championships. (Crier photo.)

Chiefs set sights on crown

BY CHAS CHILD

With four of five starters returning from last year's squad, Canton looks to be the favorite for the Western Six championship this season.

The Chiefs have yet to have a winning season, but will probably have no trouble attaining that goal this year. It looks to be a season where the team will finally come into its own.

"We earned some respect last year," Coach Casey Cavell said. "This year we want to prove we're a good team. I'm looking forward to an excellent year. The players have a good attitude and are working very hard."

Only Rob Mandle graduated from last year's team which finished with 10 wins and 11 losses. His shoes won't

be easy to fill, however. Mandle was Canton's floor leader and chief playmaker.

Looking to replace Mandle are guards Doug Smith and Brent Eccles. "Brent is a good playmaker and plays good defense," Cavell said. "He played on Canton's junior varsity team two years but spent last year in California."

Cavell is also looking for great things from Guard Butch King, who as a sophomore last year was the Chiefs' leading scorer. "He's one of the best shooters the Plymouth area has had in years," his coach said. "He's also very steady, makes few mistakes and plays solid defense."

Another starter from last year is

Cont. on pg. 19

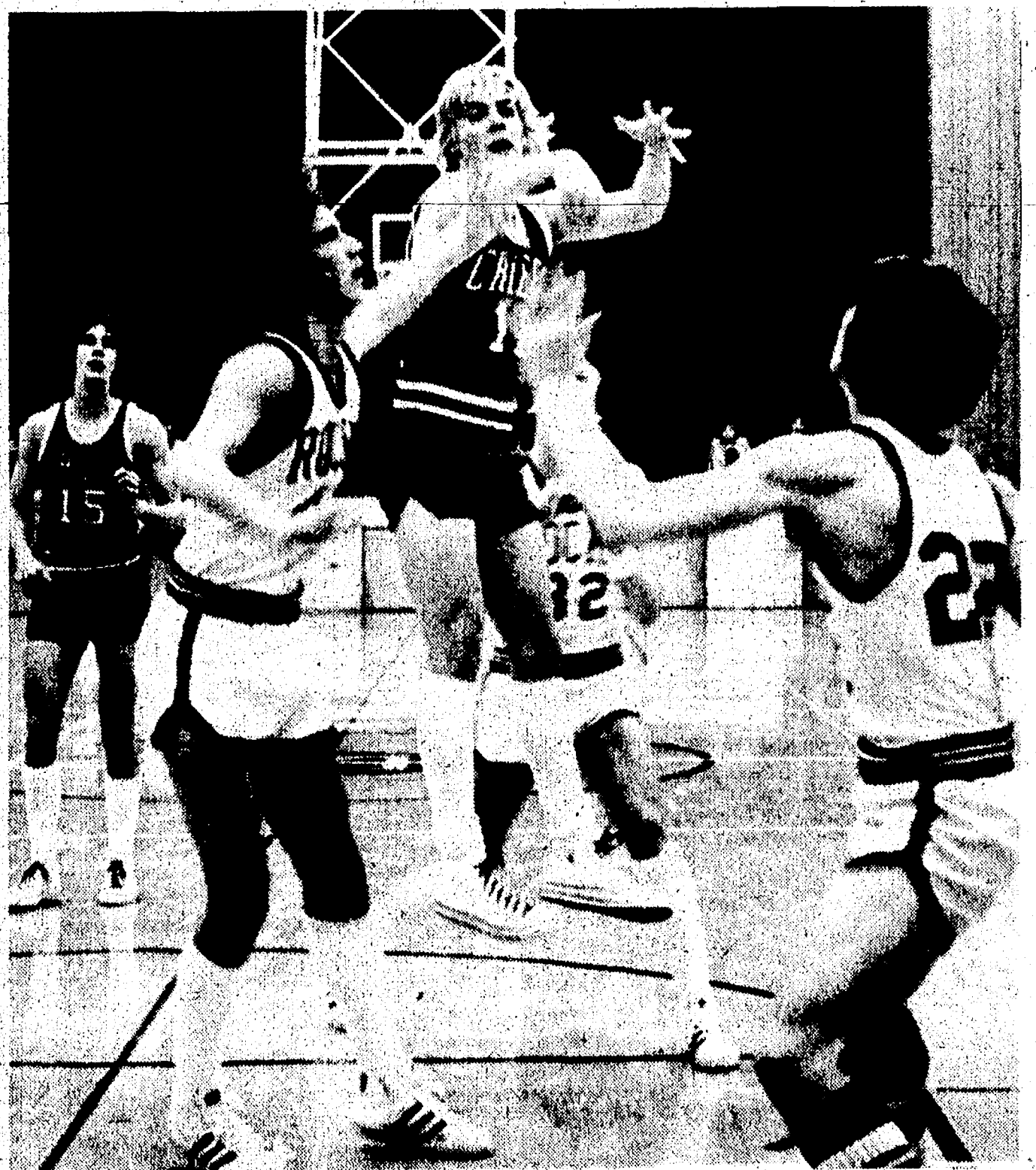

RANDY RENAS of Canton passes off against Salem in action last year. (Crier photo by Susan Sheiner.)

Salem, Canton announce winter sports schedules

CANTON JV & VARSITY BASKETBALL			
DATE	OPPONENT	PLACE	TIME
Fri. Dec. 2	Harrison	T	6:15 p.m.
Tues. Dec. 6	Belleville	T	6:30 p.m.
Fri. Dec. 9	W. L. Western	H	6:30 p.m.
Tues. Dec. 13	S'field Lathrup	H	6:30 p.m.
Fri. Dec. 16	Churchill	T	6:15 p.m.
Tues. Dec. 20	Bentley	H	6:30 p.m.
Tues. Jan. 3	Franklin	T	6:15 p.m.
Fri. Jan. 6	Northville	H	6:30 p.m.
Tues. Jan. 10	Farmington	H	6:30 p.m.
Fri. Jan. 13	Waterford Mott	T	6:15 p.m.
Tues. Jan. 17	Annapolis	H	6:30 p.m.
Fri. Jan. 20	Harrison	H	6:30 p.m.
Tues. Jan. 24	Bentley	T	6:30 p.m.
Fri. Jan. 27	W. L. Western	T	6:15 p.m.
Tues. Jan. 31	Thurston	H	6:30 p.m.
Fri. Feb. 3	Churchill	H	6:30 p.m.
Tues. Feb. 7	Stevenson	T	6:15 p.m.
Fri. Feb. 10	Northville	H	6:30 p.m.
Fri. Feb. 17	Waterford Mott	T	6:30 p.m.
Tues. Feb. 21	Dearborn	H	6:30 p.m.
Feb. 27 - Mar. 4	Districts		
Mar. 7-11	Regionals		
Mar. 15, 17, 18	State		

SALEM JV & VARSITY BASKETBALL			
DATE	OPPONENT	PLACE	TIME
Tues. Nov. 22	W. L. Central	T	6:15 p.m.
Tues. Nov. 29	Franklin	H	6:30 p.m.
Fri. Dec. 2	Allen Park	T	6:30 p.m.
Fri. Dec. 9	Dearborn	H	6:30 p.m.
Fri. Dec. 16	Redford Union	T	6:30 p.m.
Thur. Dec. 22	Christmas Tour.	H	6:45 & 8:30 p.m.
Fri. Dec. 23	Christmas Tour.	H	6:45 & 8:30 p.m.
Tues. Jan. 3	Fordson	H	6:30 p.m.
Fri. Jan. 6	Trenton	H	6:30 p.m.
Tues. Jan. 10	Bentley	H	6:30 p.m.
Fri. Jan. 13	Belleville	T	6:30 p.m.
Tues. Jan. 17	Edsel Ford	T	6:30 p.m.
Fri. Jan. 20	Allen Park	H	6:30 p.m.
Fri. Jan. 27	Dearborn	T	6:30 p.m.
Tues. Jan. 31	John Glenn	T	6 p.m.
Fri. Feb. 3	Redford Union	H	6:30 p.m.
Tues. Feb. 7	Trenton	T	6:30 p.m.
Fri. Feb. 10	Bentley	T	6:30 p.m.
Fri. Feb. 17	Edsel Ford	H	6:30 p.m.
Fri. Feb. 24	Belleville	H	6:30 p.m.
Feb. 27 - Mar. 4	Districts		
Mar. 7-11	Regionals		
Mar. 15, 17, 18	State		

SALEM 9TH GRADE BASKETBALL			
DATE	OPPONENT	PLACE	TIME
Fri. Dec. 2	Marshall	H	3:30 p.m.
Fri. Dec. 9	Salem	T	3:30 p.m.
Fri. Dec. 16	Hilbert	H	3:30 p.m.
Thur. Jan. 12	Pierce	T	4 p.m.
Tues. Jan. 17	Wayne Franklin	T	3:45 p.m.
Thur. Jan. 19	Belleville South	T	3:30 p.m.
Tues. Jan. 24	Meades Mill	T	3:30 p.m.
Fri. Jan. 27	Salem	H	3:30 p.m.
Tues. Jan. 31	Belleville North	T	3:30 p.m.
Thur. Feb. 2	Hilbert	T	4 p.m.
Tues. Feb. 7	Meades Mill	H	3:30 p.m.
Fri. Feb. 10	Farmington East	H	3:45 p.m.
Tues. Feb. 14	Farm. Dunckle	T	3:45 p.m.
Fri. Feb. 17	Pierce	H	3:30 p.m.

SALEM VOLLEYBALL			
DATE	OPPONENT	PLACE	TIME
Tues. Jan. 10	Churchill	T	7 p.m.
Wed. Jan. 11	Thurston	T	7 p.m.
Mon. Jan. 16	Ypsilanti	H	7 p.m.
Wed. Jan. 18	Edsel Ford	H	7 p.m.
Sat. Jan. 21	Schoolcraft Inv.	T	9 a.m.
Mon. Jan. 23	Allen Park	T	4 p.m.
Wed. Jan. 25	Trenton	H	7 p.m.
Mon. Jan. 30	Bentley	T	7 p.m.
Wed. Feb. 1	Redford Union	T	7 p.m.
Mon. Feb. 6	Dearborn	H	7 p.m.
Wed. Feb. 8	Belleville	T	6:30 p.m.
Thur. Feb. 9	Northville	T	7 p.m.
Sat. Feb. 11	Edsel Ford	T	7 p.m.
Mon. Feb. 13	Allen Park	H	7 p.m.
Tues. Feb. 15	Trenton	T	7 p.m.
Wed. Feb. 21	Bentley	H	7 p.m.
Mon. Feb. 22	Redford Union	H	7 p.m.
Wed. Mar. 1	Dearborn	T	7 p.m.
Mon. Mar. 6	Belleville	H	7 p.m.
Sat. Mar. 11	Regionals		
Sat. Mar. 18	Regionals		

SALEM BOYS SWIMMING			
DATE	OPPONENT	PLACE	TIME
Thur. Dec. 1	Thurston	H	7 p.m.
Tues. Dec. 6	Stevenson	T	7 p.m.
Thur. Dec. 8	Northville	H	7 p.m.
Sat. Dec. 10	Red. Union Relays		
Thur. Dec. 15	W. Bloomfield	T	7:30 p.m.
Sat. Dec. 17	Ypsilanti Inv.	T	7 p.m.
Thur. Jan. 5	Ypsilanti	T	7 p.m.
Thur. Jan. 12	Edsel Ford	T	7:30 p.m.
Thur. Jan. 19	Bentley	H	7 p.m.
Thur. Jan. 26	Trenton	T	7 p.m.
Thur. Feb. 2	Allen Park	H	7 p.m.
Thur. Feb. 9	Redford Union	H	7 p.m.
Fri. Feb. 10	John Glenn Inv.		
Sat. Feb. 11	John Glenn Inv.		
Thur. Feb. 16	Dearborn	T	7:30 p.m.
Thur. Feb. 23	Belleville	H	7 p.m.
Thur. Mar. 2	Suburban-8	Plym.	
Fri. Mar. 3	Suburban-8	Plym.	
Tues. Mar. 7	Dividing Regionals		
Fri. Mar. 10	State Meet		
Sat. Mar. 11	State Meet		

CANTON VOLLEYBALL			
DATE	OPPONENT	PLACE	TIME
Thur. Jan. 5	Harrison	T	7 p.m.
Mon. Jan. 9	Franklin	H	7 p.m.
Wed. Jan. 11	W. L. Western	H	7 p.m.
Mon. Jan. 16	Waterford Mott	T	6:15 p.m.
Wed. Jan. 18	Brighton	T	4 p.m.
Sat. Jan. 21	Schoolcraft Inv.	T	9 a.m.
Mon. Jan. 23	Northville	H	7 p.m.
Wed. Jan. 25	Ypsilanti	T	7 p.m.
Mon. Jan. 30	Churchill	H	7 p.m.
Wed. Feb. 1	Stevenson	T	7 p.m.
Mon. Feb. 6	Ann Arbor Huron	T	7 p.m.
Wed. Feb. 8	Harrison	H	7 p.m.
Sat. Feb. 11	Plymouth Inv.		
Mon. Feb. 13	Thurston	H	7 p.m.
Thur. Feb. 16	W. L. Western	T	7 p.m.
Mon. Feb. 20	Waterford Mott	H	7 p.m.
Tues. Feb. 28	Northville	T	7 p.m.
Tues. Mar. 7	Churchill	T	7 p.m.
Sat. Mar. 11	Regionals		
Sat. Mar. 18	Regionals		

CANTON BOYS SWIMMING			
DATE	OPPONENT	PLACE	TIME
Thur. Dec. 8	Harrison	T	7:30 p.m.
Sat. Dec. 10	Red. Union Relays		
Tues. Dec. 13	Ypsilanti	T	7 p.m.
Thur. Dec. 15	W. L. Western	H	7 p.m.
Sat. Dec. 17	Ypsilanti Inv.		
Thur. Jan. 5	Redford Union	H	7 p.m.
Thur. Jan. 12	Northville	H	7 p.m.
Thur. Jan. 19	Churchill	H	7 p.m.
Thur. Jan. 26	Harrison	H	7 p.m.
Tues. Jan. 31	W. L. Central	T	4:30 p.m.
Thur. Feb. 2	W. L. Western	T	4:30 p.m.
Tues. Feb. 7	Thurston	H	7 p.m.
Fri. Feb. 10	John Glenn Inv.		
Sat. Feb. 11	John Glenn Inv.		
Thur. Feb. 16	Northville	T	7 p.m.
Thur. Feb. 23	Churchill	T	7 p.m.
Thur. Mar. 2	Western-6	Harson.	
Fri. Mar. 3	Western-6	Harson.	
Tues. Mar. 7	Dividing Regionals		
Fri. Mar. 10	State Meet		
Sat. Mar. 11	State Meet		

SALEM GIRLS GYMNASTICS			
DATE	OPPONENT	PLACE	TIME
Wed. Jan. 18	Belleville	H	7 p.m.
Wed. Jan. 25	N'ville & Oak Park	N'ville	7 p.m.
Wed. Feb. 1	Walled Lake Central	H	7 p.m.
Mon. Feb. 6	N. Farmington	T	7 p.m.
Wed. Feb. 15	Canton	T	7 p.m.
Wed. Feb. 22	W. L. Western	H	7 p.m.
Tues. Feb. 28	Farmington	T	7 p.m.
Sat. Mar. 4	Regionals		
Fri. Mar. 10	State Meet		
Sat. Mar. 11	State Meet		

CANTON GIRLS GYMNASTICS			
DATE	OPPONENT	PLACE	TIME
Mon. Jan. 16	W. L. Central	T	7 p.m.
Wed. Jan. 25	Belleville	T	7 p.m.
Mon. Jan. 30	N. Farmington	T	7 p.m.
Mon. Feb. 6	W. L. Western	H	7 p.m.
Wed. Feb. 15	Salem	H	7 p.m.
Mon. Feb. 20	N'ville & Harrison	N'ville	7 p.m.
Tues. Feb. 28	Farmington	T	7 p.m.
Sat. Mar. 4	Regionals		
Fri. Mar. 10	State Meet		
Sat. Mar. 11	State Meet		

SALEM WRESTLING			
DATE	OPPONENT	PLACE	TIME
Sat. Nov. 26	Ann Arbor Huron-Dual (Stevenson-Saline-Salem)	T	
Tues. Nov. 29	Northville	T	6:30 p.m.
Thur. Dec. 1	Dearborn	T	6:30 p.m.
Sat. Dec. 3	Allen Park Inv.	T	
Thur. Dec. 8	Belleville	H	6:30 p.m.
Sat. Dec. 10	Thurston Inv.	T	8 a.m.
Tues. Dec. 13	Quad Meet (Canton-Clville-Frank.)	H	6 p.m.
Thur. Dec. 15	Edsel Ford	T	6:30 p.m.
Tues. Dec. 20	W. L. Western-Quad Meet (Ann Arb.-Pioneer-Ypsi-Salem)	T	5 p.m.
Thur. Dec. 29	Canton Christmas Tour.	T	
Thur. Jan. 5	Bentley	H	6:30 p.m.
Fri. Jan. 6	Schoolcraft Inv.		
Sat. Jan. 7	Schoolcraft Inv.		
Thur. Jan. 12	Trenton	T	6:30 p.m.
Sat. Jan. 14	Plymouth Inv.	Salem	11 a.m.
Tues. Jan. 17	Annapolis-Double Dual	T	6:30 p.m.
Thur. Jan. 19	Allen Park	H	6:30 p.m.
Thur. Jan. 26	Redford Union	H	6:30 p.m.
Sat. Jan. 28	Suburban-8 Districts	Bentl.	
Sat. Feb. 4	Suburban-8 Districts		
Sat. Feb. 11	Regionals		
Fri. & Sat. Feb. 17 & 18	State Meet		

CANTON WRESTLING			
DATE	OPPONENT	PLACE	TIME
Sat. Nov. 26	Northville Inv.	T	11 a.m.
Tues. Nov. 29	Bentley	T	6:30 p.m.
Sat. Dec. 3	John Glenn Inv.	T	12 p.m.
Thur. Dec. 8	Harrison	T	6:30 p.m.
Sat. Dec. 10	Thurston Inv.	T	8 a.m.
Tues. Dec. 13	Quad Meet (Salem-Clville-Frank.)	Salem	6 p.m.
Thur. Dec. 15	W. L. Western	H	6:30 p.m.
Sat. Dec. 17	Clarenceville Inv.	T	
Tues. Dec. 20	W. Bloomfield Quad	T	
Thur. Dec. 29	Canton Christmas Tour.	H	
Thur. Jan. 5	Waterford Mott	T	6:30 p.m.
Fri. Jan. 6	Schoolcraft Inv.		
Sat. Jan. 7	Schoolcraft Inv.		
Thur. Jan. 12	Northville	H	6:30 p.m.
Sat. Jan. 14	Plymouth Inv.	Salem	11 a.m.
Tues. Jan. 17	Robichaud-Triang. Meet	T	6:00 p.m.
Thur. Jan. 19	Churchill	H	6:30 p.m.
Tues. Jan. 24	Stevenson	H	6:30 p.m.
Sat. Jan. 28	Western-6 Districts	Plym.	
Sat. Feb. 4	Districts		
Sat. Feb. 11	Regionals		
Fri. & Sat. Feb. 17 & 18	State Meet		



BE A WINNER... AND JOIN THE USING NUMBER OF MEMBERS AT COMMUNITY FEDERAL CREDIT UNION

People Working Together for

500 S. Harvey 453-1200 **Serving the Plymouth, Canton & Northville Communities**

Junior cagers begin registration next month

BY CHAS CHILD

With 175 girls and 580 boys already practicing, the Plymouth-Canton Junior Basketball Association, (PCJBA) is looking forward to another fun year.

Starting it's 14th season, the PCJBA is adding two new divisions for 11th and 12th graders. The new divisions are AAA girls and AAA boys. The girls will have four teams, the boys, eight.

A total of 80 teams from the third through 12th grades will be participating.

All games will be played on Saturdays at the school district's four middle schools, and at two elementary schools. The public is welcome to all the games free of charge.

Ron Mack of the PCJBA credits a good deal of the success of the Salem and Canton high school teams to the PCJBA. The girls program was started five years ago.

A major part of the PCJBA's philosophy is that everyone plays. "All boys and girls on each team will play a minimum of one quarter (eight minutes) and not more than three quarters of each game," the Association's handbook says.

The handbook also states that "All referees for scheduled games are high school boys and girls from the Plymouth-Canton schools. These boys and girls are paid and trained by our organization. Many are just learning referee skills and should be treated with respect by the players, coaches and fans."

At the end of the regular season,

all the divisions will hold tournaments, except the "C" teams, the third and fourth graders.

Mack said there is still room for players in some divisions. Here is a list of the leagues and the persons to contact:

A Boys, sixth and seventh grades, Ed O'Donnell, 459-1386.

AA Boys, eighth, ninth and 10th grades, Mike Adzima, 459-3008, or Larry Arnold, 981-1218.

AAA Girls, 11th and 12th grades, Jack Christie, 453-2406.

AAA Boys, 11th and 12 grades, Doug Jones, 455-1144.

Anyone interested in playing on these teams may also register at Central Middle School on Dec. 3 from 9 a.m. until noon. Dec. 3 is the deadline for registration.

Sign up soon for city rec basketball

New basketball teams in the Plymouth recreation Department league may register today (Nov. 9) through Nov. 18. The entrance fee is \$200 per team.

Northville's four teams recently withdrew from the league so the team limit has changed from 16 to 12 teams. Returning team registration ended today. For further information, call the Plymouth Recreation Department at 455-6620.



ATTENTION DEER HUNTERS! SPORTSMAN'S VILLAGE

Has Your Deer Hunting Needs
Guns, Ammunition, Clothing, Licenses
& Hunting Accessories



Reg.
\$22.75

SPECIAL!
CONVERSE FELT
PAC BOOTS
NOW **-\$12.89**

Stop In and Enter Our
BIG BUCK CONTEST

(No
Obligation
Necessary)

TAXIDERMY SERVICE is available

For The DIE-HARD FISHERMAN

We still have a large assortment
of tackle & live bait

45430 Ford Rd. at Canton Center Rd.
THE KENNEDY PLAZA
CANTON
455-6666

Poulan microxxv GAS POWERED SAWS

M25-10"

\$79⁹⁵

M25D-12"

99⁹⁵

MS25D-14"

129⁹⁵

*Factory suggested list price.

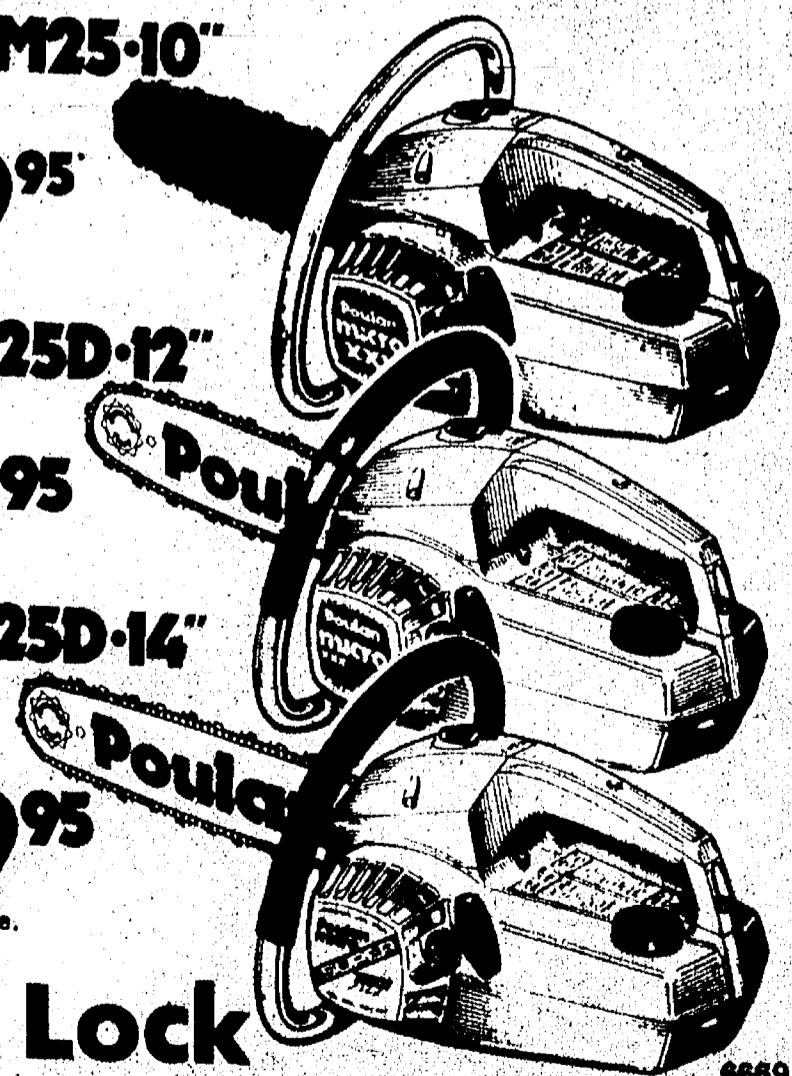

Passage Lock and Saw Shop

181 Rose Street
453-7454

Main

Amelia

181
Rose

Hardees

Mill



**9456 LILLEY
PLYMOUTH
455-5300**

OPEN SEVEN DAYS
15 MINUTE
PICK-UP SERVICE
DELIVERY AVAILABLE

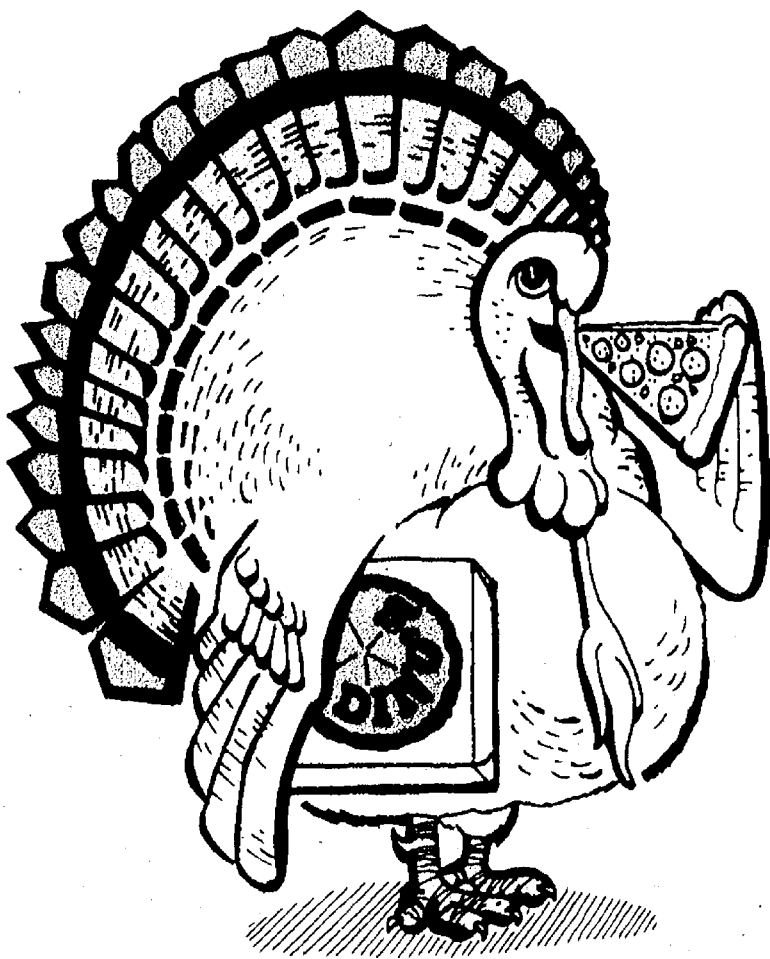

THE BEST STUFFING IN
TOWN... DINO'S PIZZA

**DINO'S
PIZZA**

ROUND	S	M	L	PARTY TIME
Cheese	2.35	3.10	4.10	4.95
Cheese & 1 Item	2.95	4.05	5.05	5.95
Cheese & 2 Items	3.60	4.75	5.85	6.55
Cheese & 3 Items	3.95	5.10	6.20	6.95
Cheese & 4 Items	4.35	5.45	6.70	7.45
Special	4.90	5.85	7.05	8.20

Cheese, Pepperoni, Ham, Mushrooms, Green Pepper, Bacon, Onion & Anchovies.
NO SUBSTITUTIONS ON SPECIAL
CHOICE OF ITEMS: (any combination) Pepperoni, Italian Sausage, Ham, Mushrooms, Bacon, Green Pepper, Onion, Hamburger, Anchovies.

FAMILY SQUARE	S	L
Cheese	2.35	4.10
Cheese & 1 Item	2.95	5.05
Cheese & 2 Items	3.60	5.85
Cheese & 3 Items	3.95	6.20
Cheese & 4 Items	4.35	6.70
Special	4.90	7.05

Cheese, Pepperoni, Ham, Mushrooms, Green Pepper, Bacon, Onion & Anchovies.
NO SUBSTITUTIONS ON SPECIAL
CHOICE OF ITEMS: (any combination) Pepperoni, Italian Sausage, Ham, Mushrooms, Bacon, Green Pepper, Onion, Hamburger, Anchovies.

SOFT DRINKS AVAILABLE

PRICES EFFECTIVE DEC. 1, 1977
SORRY, NO CHECKS ACCEPTED

**DINO'S
PASTA**

SPAGHETTI	
with Meat Sauce	1.95
with Mushroom Sauce	2.35
with Meat Balls	2.60
with Meat Balls & Mushroom Sauce	2.90
1/2 order	.99

RAVIOLI	
with Meat Sauce	2.20
with Mushroom Sauce	2.60
with Meat Balls	2.90
with Meat Balls & Mushroom Sauce	3.10
1/2 order	1.09

LASAGNA DINNER	3.20
----------------	------

The Dinners above are served with Garlic Bread and Parmesan Cheese

HOURS: MON.-THUR. 11:00A.M.-12:00A.M.
FRIDAY 11:00A.M.-2:00A.M.
SATURDAY 12:00P.M.-2:00A.M.
SUNDAY 4:00P.M.-12:00A.M.

OPEN SEVEN DAYS

**DINO'S
SUBMARINE SANDWICHES**

Roast Beef Sub.	1.25
Lite Italian Sub.	.98
Lite Ham & Cheese Sub.	.98
Meat Ball Sub.	1.35
Corned Beef Sub.	1.35
Hamburger Sub.	1.25
Italian Sausage Sub.	1.25
Pizza Sub	1.35
Turkey Sub.	1.35
Vegetarian Sub.	1.25
Italian Sub.	1.35
Ham & Cheese Sub.	1.35

SALADS	
Lettuce, Cucumber & Tomato	.87
Choice of Dressing	
Cote Slaw	.65

MINI PIZZA	
WITH CHEESE	1.50
.25 each additional item	
PIZZA FLIP (PIZZA PASTY)	.96

DINO'S PIZZA

455-5300



PARTY PIZZAS

Cooked or uncooked in their own pans, can be warmed up or frozen and cooked later.

Small with Cheese
Uncooked: 2.95 - Cooked: 3.65
(50¢ each additional item)

Large with Cheese
Uncooked: 5.69 - Cooked: 6.50
(75¢ each additional item)

DINO'S COUPON

\$1.00 OFF

**ANY
PURCHASE
\$5.00 or more**

ONE COUPON PER PURCHASE
PICK-UP ONLY
EXPIRES DEC. 31, 1977

DINO'S COUPON

50¢ OFF

**ANY
PURCHASE
\$3.00 or more**

ONE COUPON PER PURCHASE
PICK-UP ONLY
EXPIRES DEC. 31, 1977

Canton expects respect

Cont. from pg. 15

Senior Forward Randy Reinas. "He'll be one of our leading scorers," Cavell said. "He's strong, a good rebounder and shooter. Plus he's very experienced."

The Chiefs will also have Rusty Mandle, Rob's brother, back at the forward position. Last year as a sophomore, Mandle worked his way into a starting position. "He'll be one of our strongest men on the inside," said his coach.

Cavell will be looking to Keith Fueling to create a lot of turnovers. "Keith keeps things going on the court. He



Canton Coach Casey Cavell

goes after the loose ball and has a lot of hustle."

These players will be the mainstays carrying out Cavell's system of 2 man-to-man defense and a "movement" offense which relies on a lot of motion from the players without the ball.

"I would call our offense a 'controlled fast-break.' We have few set patterns," Cavell said. "It's a passing offense."

On defense, Cavell said his team will rely on a basic man-to-man. "We'll stick to them all the way."

Three juniors, Dale Albright, Jay McKinley and Kurt Herbert will also see a lot of playing time. Herbert was the leading scorer on the junior varsity team last year with a high game of 37 points.

Albright will be challenging for the ball-handling guard position and Mc Kinley is strong on the boards, Cavell said.

In the Western Six League, Cavell said "we, hopefully, are the favorites. The main challengers will probably be Northville and Harrison, although the league is fairly even. Harrison has the most height and Northville, the most depth."

"We're looking for an excellent year. We want to be respected," the coach said.

Rocks eye title repeat

Cont. from pg. 15

have a good knowledge of their roles and think of themselves as team players," the coach said.

With the team's quickness and depth, Thomann said he will be trying to wear down his opponents. "We'll use a lot of presses and be able to expend a lot of energy."

The Rocks use a man-to-man pressure defense. "We try to force as many mistakes as we can," said Thomann.

On offense, Salem will rely on a passing game versus set plays. This involves reading the defense and deciding

how best to attack each time, Thomann said.

In the Suburban Eight, the top challengers to the Rocks will probably be Bentley and Redford Union.

"Bentley is tall and good while Redford Union is rugged," Thomann said. "And of course, Belleville has Kelvin Patterson who can carry the team all by himself."

To help them in this year's campaign Salem also has a group of five returning junior varsity players, all juniors: Paul Dillon, Kevin Kelligher, Barry Owens, Bill Thimm and John Van Waggoner.



PG. 19 THE COMMUNITY CRIER: November 9, 1977

Santa's word to merchants:

A Community Christmas

in The Crier, Nov. 23rd, will be worth a special trip from the North Pole

Contract your Crier advertising representative soon

453-6900

We need
USED SPORTING GOODS!!



EARN EXTRA MONEY FOR THE HOLIDAYS!

The used sporting goods equipment being stored in your garage, attic or basement could earn you extra spending money!

Why not gather it up, Bring it to
Plymouth Sports Shop
and let us sell it for you!



Plymouth Sport Shop

Call **455-1550** for merchandise pick-up

863 W. ANN ARBOR TR.

MARIA'S ITALIAN BAKERY

SPECIAL EVERYDAY PIZZA BY THE PIECE
40¢

Complete Line of Party Goods

Home of the Square Pizza

SQUARE PIZZA	small 6 pcs.	large 12 pcs.	x-large 24 pcs.
CHEESE	1.74	3.00	6.00
CHEESE & ONE ITEM	1.89	3.25	6.50
CHEESE & TWO ITEMS	2.14	3.75	7.25
CHEESE & THREE ITEMS	2.39	4.25	8.00
CHEESE & FOUR ITEMS	2.64	4.75	8.75
MARIA'S SPECIAL	3.14	5.75	9.50

With Cheese, Pepperoni, Ham, Mushrooms, Green Pepper, Bacon, Onion

CHOICE OF ITEMS: Pepperoni, Bacon, Hamburger, Green Pepper, Anchovies, Ham, Mushrooms, Onions, Black Olives, Italian Sausage

Baked at no extra charge
Baking Instructions: Rise 20 minutes, bake 425 degrees for 20 minutes.

DOMESTIC & IMPORTED BEER & WINE TWO LOCATIONS

115 HAGGERTY (Corner Cherry Hill) 981-1200	38411 JOY ROAD (Joy-Hix Shopping Center) 455-0780
HOURS: 8-10 Daily, 8-6 Sunday	HOURS: 8-6 M-T-W-Th, 8-7 Friday & Saturday



Econograde
LUMBER
2"x4"x8'
79¢
2"x4"x7' **59¢**

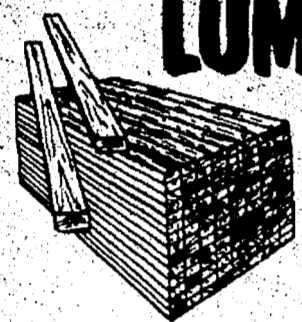

LUMBER STRIPS
1"x3"x8' 3 for
39¢ each \$1.00

Flush Birch Interior
DOORS
HOLLOW CORE
2/6 X 6/8
SALE **\$15.50**



Flush Mahogany
2/6 X 6/8
Hollow Core
INTERIOR DOORS
Sale **\$10.50**

MAHOGANY INTERIOR PRE-HUNG DOORS
2/6 X 6/8
reg. \$30.75
SALE **\$20.95**

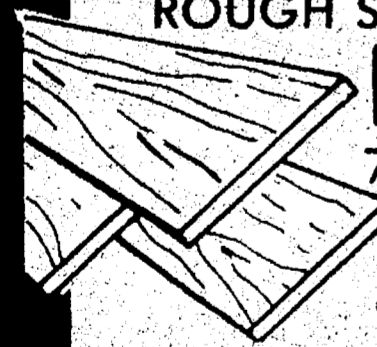

12" X 12" AND 2' X 4"
CEILING TILE
INVENTORY
CLOSEOUT!
25% off
SPECIAL SELECTION



ROUGH SAWN
PINE
7/8"x12"
52¢
per lineal foot

WEATHER STRIPPING SUPPLIES
10% off

COMBINATION STORM & SCREEN DOORS
15% off
any in stock.

25% off ALL WALLPAPER ORDERS
Plymouth Store Only

15% - 60%
off all Paneling
In Stock!

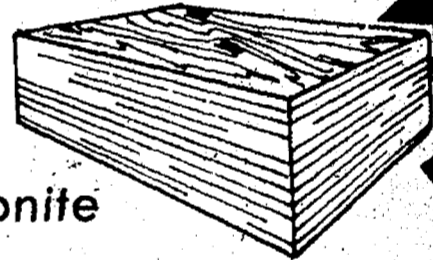

Abitibi • Masonite
Georgia Pacific • PWP

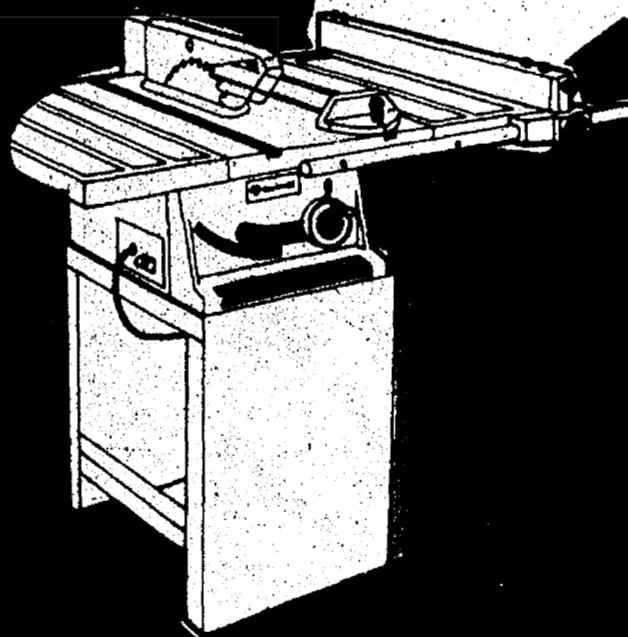

25% OFF ALL HWI PAINTS & STAINS

15% OFF
Skil ROUTER
\$29.95
No. 548



tell it to Phyllis
Call 453 - 6900 Or write 572 S. Harvey

Here we are, into the second week of November and not a snowflake has fallen. Can it mean that this winter will not be as bad as last year? Or is it simply that anyone dumb enough to make such a statement will find two feet of snow on her doorstep tomorrow morning? Let's keep our fingers crossed in hopes of a little more sunshine and warm weather.

Getting ready for the up coming winter weather and holiday season, the Canton Newcomers viewed the latest in fashions at their November dinner fashion show. Claire Kelly presented ways to keep warm in casual attire and just the right gown to be the belle of the ball at all of those holiday parties.

Wool is coming back bigger than ever this season while polyester is fading into the background. (This should make all the dry cleaning establishments very happy). Separates are just as popular as ever both in casual and formal dress. Three piece pant suits are still in, and would you believe - pleated, wool skirts (remember those from high school) are back in style again.

Winter white is popular during the holidays and for those special occasions. Long, flowing gowns are still in but they will be sharing the party spotlight with the short cocktail dress which is coming back on the scene.

No matter what you're looking for there is an abundance of styles to choose from, so good luck and happy shopping!

The Canton Newcomers have a Rose Award which they present to one of the club members who has done an outstanding job in helping out the club. November's rose was presented to Sharlene Totten by interest group chairman, Judy Thomas. Congratulations Sharlene and keep up the good work.

The sounds of car motors revving up and excitement filled the air as the Geneva Presbyterian Church held their second annual treasure hunt last Saturday night. Co-chairmen for the event were Keith and Joan Postell.

Coming in first place were Dick and Darla Minuth, Betty Vance, and Dave and Darlene Starr who won the privilege of setting up the treasure hunt next year. The second place title went to Ralph and Bevis Richardson, and Donn and Joan Wilson who were followed by Frank and Millie Conway, and Mike and Pam Mincher. Coming in last place were Bob and Marty Chandler and Sandra Froozan who narrowly beat out Ken and Linda Beach, Dennis and Sandy Kennedy, Bob and Terry Miller, and Marty and Phyllis LaForte for the booby prize.

Other couples joining in the fun trying to solve the clues were Larry and Gwen Breen, Jerry and Elise Miller, Jeff and Lynne Goldsmith, Bill and Sue Knapp, Gary and Marilyn Best, Roger and Beth Cristiani, Ralph and Lori Brickman, Terry and Cathy Grieve, Helm and Mary Ann Winter, Cork and Carol Worscheck, Nancy Laimbeer, Linda Johnson, Bob and Pat Beggs, Ron and Laurie Hellier, Gary and Kay Pressey, Rob and Pattie Grace, and Jean and Dennis Condriet.

Teri Day, a member of The Three Cities Art Club is displaying The Natural Accents at the Plymouth Credit Union for the month of November. The collection includes dried, silk and artificial floral arrangements.

The Tenth Annual Michigan State Ceramic Show for amateurs as well as professionals was held recently. Winners from the Plymouth-Canton area include Thomas Coleman who took a first and second ribbon in stains and Betty J. Manthey (vice president of 3 Cities Art) received a third place in Scraffito work. Edith Sobczyk was an honorable mention winner in the junior division.

Other residents exhibiting in the show were Ruth Fitzpatrick, Sandra and David Netz, Frances Sobczyk and Kathy Coleman, instructor and owner of TLC Ceramics.

The Grange Gleamings will hold a rummage sale this Saturday, Nov. 12 at the Grange Hall. Anyone having articles to contribute may bring them to the hall Friday afternoon or call Jesse Tritten at 453-6387 or 455-2456 for pick up. The sale will be from 9 a.m. to 5 p.m. and after 4 p.m. You can fill a bag for \$1.

The Grange also wishes to thank everyone who helped make last week's bake sale a success.



Cantonite receives rose award

SHARLENE TOTTEN (right) receives the Canton Newcomers Rose Award from Judy Thomas, Interest Group Chairperson. (Crier photo by Phyllis Redfern.)

Plymouth grad to preach

Ken Evans, a 1967 Plymouth High School graduate, is returning to Plymouth for a few days next week to preach before the First Baptist Church.

Evans is now an evangelist who has traveled in five foreign

countries and 22 states. He has appeared on The Phil Donahue Show and has written a book on his experiences called "A Seed in the Sand", on personal evangelism for youth.

Evans' began practicing his hobby of magic at five and started preaching by 13. He is now known as an evangelist and gospel magician throughout the country.

Evans received his degree in Bible for Cedarville, Ohio. He was ordained as a minister and served as a Youth Pastor at Calvary Baptist Church.

He is the son of Mr. and Mrs. Kenneth T. Evans of Maplewood Lanes in Plymouth. His parents have been Plymouth residents since 1952. He is married to Joanna Adams whom he met at Cedarville College.

Fife, Drums to go on TV

The Plymouth Fife and Drum Corp will perform in the annual Detroit Thanksgiving Day Parade on television.

"The CBS television studios have sent us a 20-page question letter regarding our Corps and what we will be performing in front of the camera," said publicity chairperson for the Corps, Kay Johnson. She said the Corps has been assigned the number two position behind the Thanksgiving Day float of the J. L. Hudson Co.

Auditions for new Corps members will be held early January Johnson said. You do not have to be a Plymouth resident to join.

Salvation Army has Thanksgiving

The Salvation Army is extending its thanks to the community by offering a special Thanksgiving Dinner this year.

Anyone who is without family or money that day can attend a family style Thanksgiving Dinner with the Salvation Army at 290 Fairground.

The only thing necessary to attend is a ticket - which is free and can be obtained at the Salvation Army or by calling 453-5464 between 9 a.m. and 2:30 p.m. No one will be admitted without a ticket. People of all ages are welcome as well as families, said Lt. William Harfoot of the Army.

Turkey, pumpkin pie and all the trimmings will be featured.

DISCOVER
19" DIAGONAL COLOR TV FOR ONLY...



- 100% Solid State Chassis
- Modular Chassis Design
- Black Matrix In-Line
- Picture Tube System
- One Touch Color System

MODEL WYA7356WD
\$359⁹⁵
Reg. \$449.95

SAVE \$80

Daily 9:30 - 6
Fri 9:30 - 9
Sat 9:30 - 5:30

Better Home FURNITURE
453-7420
1009 W. Ann Arbor Rd
Plymouth, Michigan

The Phoenix Gallery



Bills Kitchen Top & Cabinet Shop

For that personal attention:

MODERNIZE YOUR KITCHEN!

- Owner handles all work
- Free estimates

30 years in woodwork
10 years experience in plastics

882 Holbrook (in Old Village) 455-3230

MURRAY

Plymouth is for lovers-well, at least we have the mugs back at both stores!

We also are knee deep in lamps at both stores. Great Selections!

A lot of new items in the Village Soap line-Musk & Tea Rose & New Children's soaps.

Sideways has three incredible wicker trunks. Brass bound-suitable for the wicker living room.

Jules

sideways

Rocks thrash Harrison 35-13; roll into state playoff action

BY CHAS CHILD

"We're No. 1."

Pouring onto the field after whipping Farmington Harrison, the Salem football players had no doubt who was the best team in the state.

By thrashing Harrison, 35-13, the Rocks completed an undefeated season (9-0) and assured themselves a spot in the state playoffs. Three more victories and Salem will have its second state championship in four years.

The Rocks played absolutely inspired football from beginning to end. They erased any doubts about their effectiveness after losing first-string quarterback Rich Hewlett to an injury against Dearborn two weeks ago.

The man of the hour was back-up quarterback Paul Dillon who executed the Rocks' wishbone offense superbly. Dillon picked up 149 yards on 20 carries, for an outstanding average of just a shade under seven

and one-half yards per carry. Dillon also scored the Rocks' last touchdown with a 34-yard sprint near the end of the third quarter.

Senior Fullback Doug Rowe was "Mr. Paydirt" for Salem, running for two touchdowns in the first half and one in the second.

The battle between the Western Six champs (Harrison) and the Suburban Eight winners (Salem) proved to be not much of a contest.

The Hawks opened the scoring in the first quarter after a Salem fumble near their own 35-yard line gave Harrison the ball.

Hawk quarter-back Brett Homovec capped the drive with a 10-yard pass to End Brad Bache with 7:26 left on the clock. The kick was good for a 7-0 Hawk lead.

From here, however, the game belonged to the Rocks, whose size and strength pushed the Hawks all over the field.

On the second play from scrimmage after the kickoff, Rowe broke into the clear and sprinted 75 yards before he was dragged down from behind on Harrison's 20-yard line.

Halfback David Booker put the ball in the end zone with a 14-yard run around left end. Dave Basierbe's kick was good to knot the game at 7-7.

The Rocks fought to a 21-7 halftime lead with two long drives capped by short touchdown plunges by the 6 foot, 186-pound Rowe. The last one came with only 19 seconds showing on the clock in the second quarter.

Salem came out of the locker room still fired up and wasted little time getting on the scoreboard.

Rowe scored his final touchdown on a 21-yard burst at 8:02 of the third stanza. And Dillon got one of his own by scrambling into the end zone from 33 yards out. The quarterback showed great second effort by breaking at least three on the run.

The Hawks did manage to get on the scoreboard in the fourth quarter, but it was too little, too late. Harrison's Fred Blackmer plunged over from the four-yard line. The Hawks attempted a two-point pass conversion but Homovec's pass was broken up.

the Crier Sports



QUARTERBACK Paul Dillon lofts a pass in Friday's convincing victory over Farmington Harrison. (Crier photo by Bill Bresler.)

Rocks face Portage Cent. Friday

With a 9-0 regular season behind them, the Rocks now head into a brand new season - the playoffs.

Salem finished with the highest point total in District II and will play Portage Central, who finished second in the district.

The quarterfinal contest will be played at Brighton High School, 7:30 p.m., Friday, Nov. 11.

All tickets for the game will cost \$1.50. Students may buy them at CEP's Athletic Office from 7:30 a.m. to 1:30 p.m. today (Wednesday), and the general public may purchase them on Wednesday from 1:30 p.m. to 3 p.m. and on Thursday from 10:30 a.m. to 12:30 p.m.

To get to the football field, enter Brighton going west on

Grand River and turn left on Main Street. From Main, turn left on 7th Street and continue on 7th until you reach Brighton High School which will be on the right. The stadium is behind the school.

Salem is the home team and the Rocks' fans will be sitting on the press box side of the stadium. The CEP Marching Band will also be there.

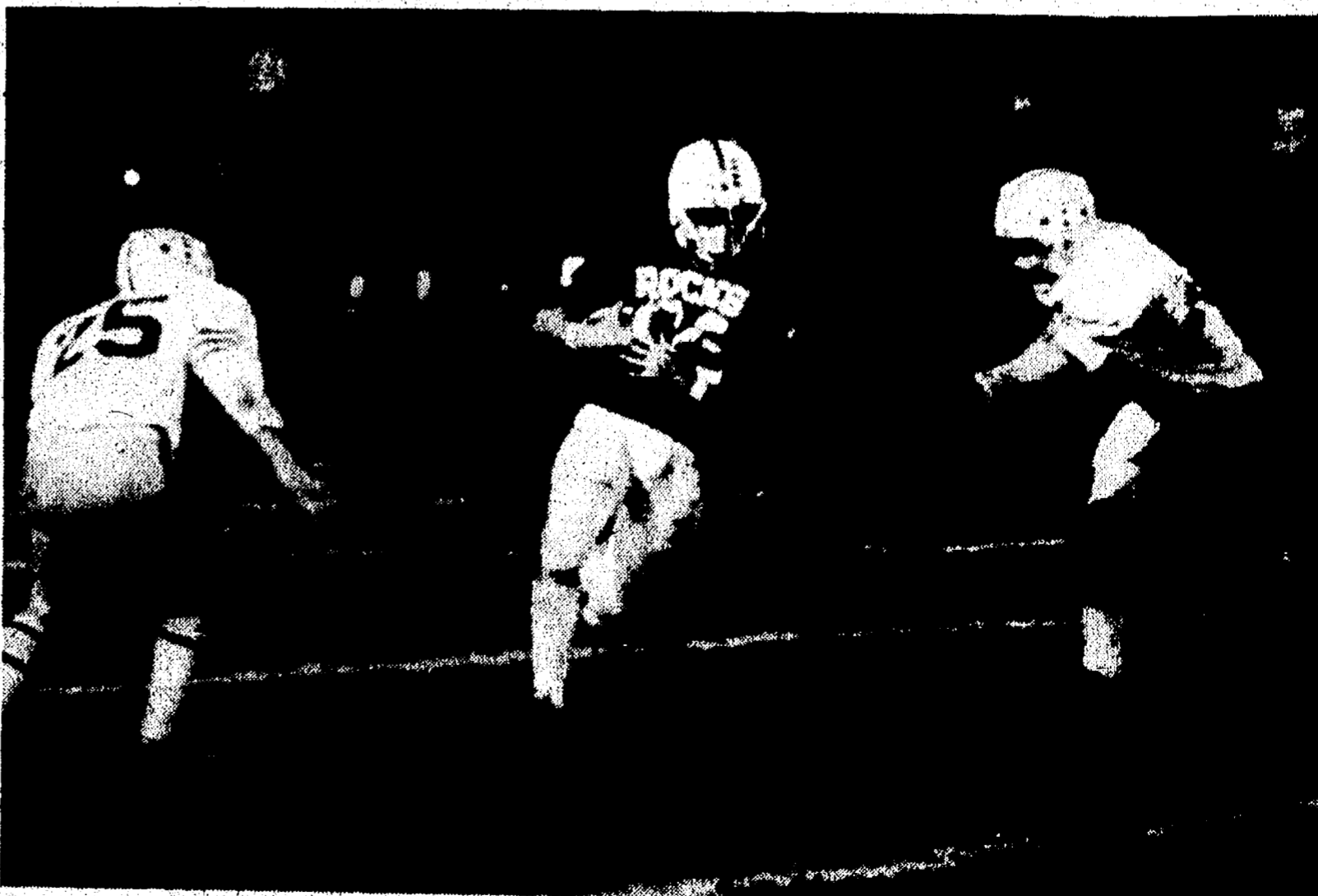

DILLON dances through would-be Harrison tacklers. The quarterback came off the bench to lead the Rocks into the playoffs

Friday. Their opponent will be Portage Central. (Crier photo by Bill Bresler.)

Something to Share with Someone.

IT'S FUN!

TO EAT AND DRINK at...

Little Caesars Family Inn
PLYMOUTH

1492 SHELDON RD. at Ann Arbor Rd.

'Pizza is our Special
we also have delicious dinners

Veal Parmegiana

Spaghetti

Lasagna



Ready To Bake PIZZA

Cheese & 1 Item \$2.25
Extra Items \$.50

Free Pizza Coupons

Carry Out Only!

Monday Special

We will honor all
Pizza coupons

EAT IN OR CARRY OUT

453-1000

Strong-arm tactics have no place on sidelines

Chas Child



During Friday's Salem-Harrison football game, one of Salem's assistant coaches, on orders from Head Coach Tom Moshimer, threatened to call the police and arrest me, threatened to break The Crier photographer's camera and pushed me around the field.

Why?

Because I predicted the Rocks would lose the game after losing star quarterback Rich Hewlett.

Mere words on a page provoked physical harassment and threats of arrest.

Is this the kind of example we want our coaches setting for the young men of this community? Absolutely not.

These were the events leading up to the threats:

Throughout the season, several newspaper reporters and photographers have covered both Canton and Salem football games by walking up and down the sidelines, following the action.

When the ball was between the 35-yard lines, I usually stood on the players' bench to see over their heads.

I stayed clear of the players and the coaches running the game, and they, in turn, ignored me.

Covering games in this fashion is very common. I was taught this method by Tom Schram, former sports editor of the Observer & Eccentric newspapers.

I and others sports repor-

ters from other papers have used this method all season and not once has a coach from either Canton or Salem told me it was against their rules. Until Friday.

After the kickoff the ball was near midfield, so I stood on the Salem bench to see the game. The whole team was crowded near the sidelines, yards away, with their backs toward me watching the game.

Immediately, Allie Suffety, a team trainer, told me I was not allowed on the sidelines anymore, and must watch the game from the stands.

I argued the point and Suffety said that Moshimer told him I must then watch the game from outside the 30-yard lines, beyond the "players area."

I still objected, since this was the first time I'd ever heard of the "players area," and photographers and a number of kids who were obviously not Salem football players moved freely between the 30-yard lines.

I did, however, step down off the bench at the trainer's insistence.

Despite this, Suffety forcibly pushed me outside the 30. Later, when I moved inside the 30 following the game's action, he pushed me away again and said that Moshimer threatened to have me arrested.

When I refused to leave a spot on about the 35-yard line on another occasion, Suffety stood directly in front of me, blocking my view of the game. He also threatened to break the camera of The Crier's

photographer, Bill Bresler, taking pictures of the coach's action.

"How would you like me to break your camera?" he asked Bresler.

Suffety, even refused to give me his right name. He said his name was "Alex Dimento."

After Salem had a comfortable lead, I was ignored and allowed to walk up and down the sidelines as I wished.

And I repeat: No other non-player was told to leave the "players area" not even other press representatives.

As far as I can tell, the reason for all this childish bullying was my prediction column last week where I said the game was going to be close, but Salem would lose. It was an honest prediction - I called it like I saw it.

In my account of the game last week, the team was also irritated that I had written that the team's chances for making the playoffs were dimmed by the loss of Hewlett, an assistant coach told me later.

This is not the first time that my writings have disturbed Moshimer. Before the season began, I broke the story that Moshimer intended to quit his coaching position after this season.

In a conference call with Salem Principal Bill Brown,

the coach refused to comment on his reasons for resigning.

I, therefore, published his reasons as related by school administrators.

The "players area" was a phony issue. It was the prediction which prompted Moshimer's reaction. Suffety even told Bresler later in the game that Moshimer's orders were: "Get him out of here, you saw the article."

Moshimer's irritation over my story is one thing; his threats are quite another.

This kind of personal harassment of the press can't be tolerated by the school administrators.

Moshimer isn't teaching sportsmanship; he is teaching personal harassment that threatens the good name of Plymouth-Canton athletics and the good name of our school district.

Chas picks 'em



As Salem heads into the playoffs, Swami Chas is somewhat at a loss: My crystal ball is clear (usually) but its only a local model. Unfortunately, it can only pick up the nearby channels.

I've applied to Soothsayer's Local 110 for a permit for a larger antenna, but right now I can't pick up anything west of Muleshoe, which for those of you who don't know, is a good deal east of Portage, the home of Salem's quarterfinal opponents Friday, Portage Central.

I've washed my crystal ball with windex, banged the top, and fiddled every dial, but there's no getting rid of the snow on channels west of Muleshoe.

So, with no prediction possible I did the next best thing: I called Robert Knight, the coach of Portage Central, and asked for a brief sketch of what Salem's fans can expect Friday.

On offense, Central runs a Houston veer offense led by Quarterback Pete Metzelaars. "He runs the ball well and can also pass," Knight said.

For his running attack, Knight relies on Todd Lipschutz and Kevin Mowan. Lipschutz has gained about 800 yards on the season and Mowan about 600.

Defense, however, is Central's forte. The team allowed only 21 points in their last six contests. On the year they racked up three shutouts.

"We use multiple defenses and jump around a lot," Knight said. "If we do use any blitzes against Salem, they will probably be outside ones to try and stop their options."

Central's coach said he felt honored to play Salem and said his team will have its hands full.

"If you try to take away Salem's inside game, they'll go outside. If you try to take away their outside game, they'll go inside," he said. "They execute very well, and we'll be concentrating on trying to take away their big plays."

This year is the first time Central has gone undefeated and it's their first trip to the state playoffs.

FIREWOOD
we deliver

CALL TODAY

478-0973

CHARGE IT!

1226 S. Main

hair apparent
UNISEX STYLING

FREE! Bottle of Shampoo
with
Wash, Cut & Blow Dry
with coupon until 11/16
Evenings by Appointment
Under New Ownership

453-5010

The Pilgrims First Thanksgiving Dinner

Authentically Re-created at the Mayflower Meeting House

The Pilgrim heritage has long been a tradition not only in Plymouth, Michigan but especially at the Mayflower. To continue this practice, we have meticulously researched the service and preparation of the Pilgrim Fathers' First Thanksgiving Dinner. With certain liberties, the menu is a duplicate of that Thanksgiving Dinner menu used by the Pilgrims in 1621.

Join us Thanksgiving Day November 24, 1977,
1 PM - 7 PM
Adults \$12 Children under 10 years \$6
The Mayflower Meeting House
455 S. Main, Plymouth
Advance Reservations Only 453-1620

SERVING

PLYMOUTH-CANTON
COMPLETE OFFSET
PRINTING SERVICE

featuring
3M
412
CAMERA

Call
453-6770

The Pilgrim Printer
632 S. MAIN PLYMOUTH

Dearborn leaves Chiefs winless

BY CHAS CHILD

A long and tough afternoon ended a long and tough season for the Canton football team Friday.

The Chiefs lost to a big, strong Dearborn team, 47-13, on a gray and overcast day in Ford Motor Company's capital city.

The winless Chiefs found no outlet for their season-long frustrations as the Pioneers scored the first three times they had the ball.

And Dearborn's star quarterback, Dennis Scala, played through the third quarter, rolling up points to impress college scouts.

The game was also plagued by penalties, virtually all against the Pioneers, probably taking out their frustrations after getting whipped by Salem the week before.

The Chiefs' passing game - Quarterback Rusty Mandle to End Randy Rienas - sparkled briefly, but was in the end not a factor compared to the onslaught of Dearborn touchdowns.

Canton fell behind immediately when Pioneer halfback Kevin Gotts sprinted 54 yards on the fourth play from scrimmage after the opening kickoff.

Canton's fans held their breaths when the Chiefs got the ball back however. In just three plays Canton was in the end zone.

Taking over on Canton's 37-yard line, Mandle hit Rienas on a 28-yard pass play that took the ball to Dearborn's 35.

Mandle ran for four yards on the next play and then hit Rienas cutting across the middle. The senior end sprinted to paydirt to pull Canton within one point.

From here, though, the game belonged to Dearborn. The Pioneers rolled up 40 unanswered points to put the game out of reach.

Scala and Gotts, co-captains of the Dearborn squad, did most of the damage. On scoring drives of 80 and 36 yards, the Pioneers pulled into a 20-6 lead at the end of the first quarter.

Near the end of the second quarter, Dearborn backed the Chiefs up inside their own 10-yard line, forcing a short punt and allowing the Pioneers to take over on Canton's 22. Five rushes later, Dearborn tallied to make the score 27-6 at halftime.

The scoring spree showed no signs of letting up in the third quarter. The Pioneers pushed into paydirt on their first three possessions to boost their lead to 47-6.

The Chiefs scored their other touchdown midway in the last quarter on a drive rife with Dearborn penalties.

Canton recovered a Pioneer fumble on Dearborn's 30-yard line. Quarterback Doug Smith was sacked for a 13-yard loss, but two Dearborn penalties - roughing the passer and pass interference in the end zone - brought the ball down to the Pioneers' 10 yard line.

Smith then passed to End Jay McKinley for the touchdown.

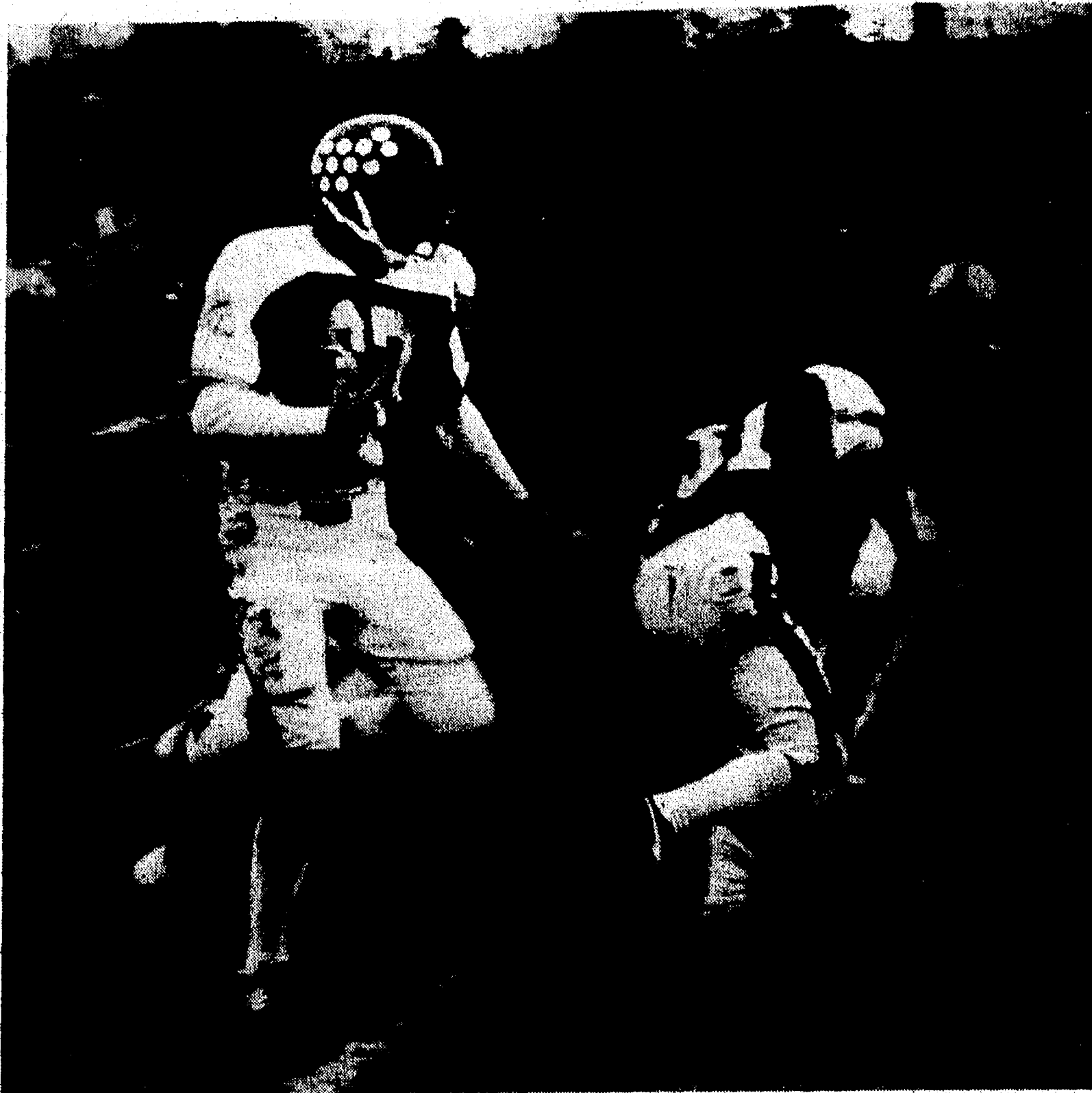

END RANDY RIENAS picks up yardage first touchdown in the Chief's 47-13 loss. (Photo against Dearborn Friday. He scored CANTON's by Ed O'Donnell)

Chief tankers claim 2 close ones

BY JEFF REY

The Canton women's swim team was victorious two times last week beating Dearborn Fordson on Tuesday, 92-80, and squeaking past league foe Walled Lake Western on Thursday, 87-85.

During Tuesday's win Cindy Shelansky qualified for the state meet in the 100-yard backstroke. Shelansky had fallen just short of qualifying time all year, but finally made it by posting a 1:06.9. The finish was also good for a varsity record.

On Thursday, the Chiefs managed only five first place finishes, but Canton's tremendous depth made the difference in the two-point victory.

Two of the five firsts were swam by Kim Massey in the 200 and 500 freestyles. Her winning times were 2:12.6 and 5:45.8 respectively.

Shelansky also won two events. The first in the 200 individual medley with a 2:33.1 and the second in the 100 backstroke with a 1:07 effort.

The 200-yard relay team finished first, posting a 2:05.9. The swimmers in that event were Shelansky, Annette Piethe,

Laura Toor and Massey.

Peggy McElmeel took a second in the 100 freestyle turning in a 1:05.7.

In diving Jamie Zuverink placed second with a 148.35 point total.

Toor finished second in the 100 breaststroke with an effort

of 121.0 and the 400 freestyle relay team of McElmeel, Mary Reardon, Chris Perchard and Sue Vitoratos took a second with a 4:34.8.

On Thursday the Chiefs travel to Farmington Harrison for their final meet of the season. The meet begins at 7 p.m.



DIANE HARRIS, SALEM SWIMMER

Salem swimmers keep loop mark perfect

BY CHAS CHILD

Salem's tankers polished off Dearborn Thursday, 94-78, to remain unbeaten in the Suburban Eight League.

The victory came despite many girls on the team fighting off head colds. The Rocks are now 5-0 in the league and 10-1 overall.

The team of Jill McCann, Collette Cabadas, Sue and Sarah Stanwood won the 200-yard medley relay in a time of 204.2.

Sue Stanwood also contributed a first in the 220-yard individual medley and the 100-yard butterfly. Sarah Stanwood touched first in the 500-yard freestyle and chipped in a third in the 50-yard freestyle.

Sharon Ross made it 1-2 Salem in the 500 freestyle by placing second. The Rocks also took first and second in the diving. Amy McClumpha was first with 189.75 points and Lisa Lukens finished second, 170.2 points.

Marion Stanwood copped two victories: the 200-yard freestyle and the 100-yard freestyle.

In other events, McCann won the 100-yard backstroke and Cabadas took a second in the 100-yard breaststroke.

The Rocks also won the 400-yard freestyle relay with the quartet of Sue Sparling, Kim Coates, Madeleine Lakatos, and Marion Stanwood. Their time was 4:05.1.

RUGS... Beautifully

Cleaned & Sanitized

FOR SO LITTLE

WE WILL PICK UP AND STEAM CLEAN

YOUR AREA RUGS IN OUR PLANT

FURNITURE CLEANING

(VELVET FURNITURE SPECIALISTS)

FINE SELECTION OF NEW CARPETING

22 YEARS OF RUG CLEANING SERVICE

PLYMOUTH

RUG CLEANERS 453-7450

1175 STARKWEATHER PLYMOUTH

Close-Out!

40% OFF

CHRISTMAS TREES & TRIMS

FREE gift for the kiddies-While they last! (Must be accompanied by an adult.)

SAXTONS GARDEN center inc.

587 W. ANN ARBOR TRAIL PLYMOUTH • 453-6250

"EVERYTHING FOR THE GARDEN BUT THE RAIN"

HOURS:

Daily 9-6

Fri. 9-8

Sat. 9:00 to 5:00 Closed Sunday

Chief cagers undefeated

BY JEFF REY

It's good to know that the worse you can finish is a tie for first place. That's just how things stand for the undefeated Canton women's basketball team after demolishing Northville last Thursday 65-19.

The Chiefs' record stood at 15-0 after Thursday's win with only two league games remaining

and no chance of finishing beyond first place regardless of the outcome of these contests.

Canton's powerful defense led the Chiefs to their victory on Thursday by almost totaling shutting off Northville's offensive attack and finishing the game with a total of 25 steals.

The Chiefs jumped out to a quick 20-5 lead in the first

quarter with Sue Rekuc scoring six in the opening period. Canton extended its lead to 30-12 at the end of the half and nearly blanked the Mustangs during the third quarter allowing them only two points.

The final period gave Canton a chance to play the entire squad. Coach Mike McCauley said, "everyone on our team played and everyone scored."

Rekuc led the Chiefs with 10 points followed by Kelly Heaton and Evie Pasek with 9 points.

On Tuesday Canton defeated non-league opponent John Glenn 50-30.

Rekuc once again led Canton's offensive attack with 16 points. Heaton added nine points and Jill Pederson scored nine. Heaton also had 13 rebounds.

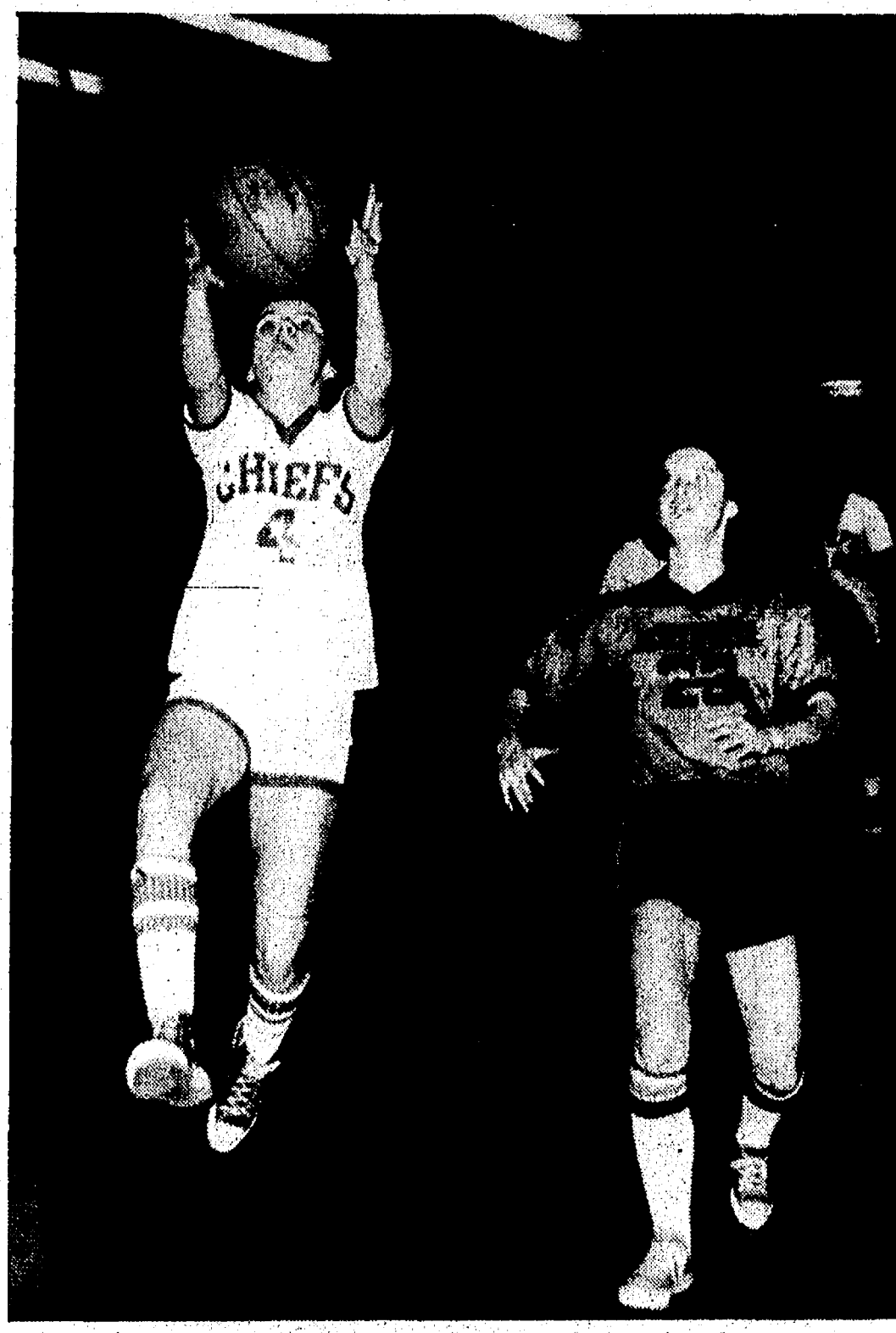

VICKY CAVALLERO drives for a lay-up in the Chief's victory over Northville Thursday. (Crier photo by Bill Bresler.)

Chiefs win Western-6

Canton's cagers sewed up an undisputed Western Six championship last night by whipping lowly Walled Lake Western, 71-21.

Even if they lose to Harrison tomorrow night, they'll still have first place all to themselves.

Vicky Cavallaro was the spark plug in the victory with her hustle and steals. "She played very well," Coach Mike McCauley said.

Laura Butler and Kelly Heaton led the Chiefs in scoring with a total of 12 points each. Kathy Sochacki added 10 and Cavallaro dropped in eight.

The win leaves Canton with a 16-0 record, the best in the Metro West area.

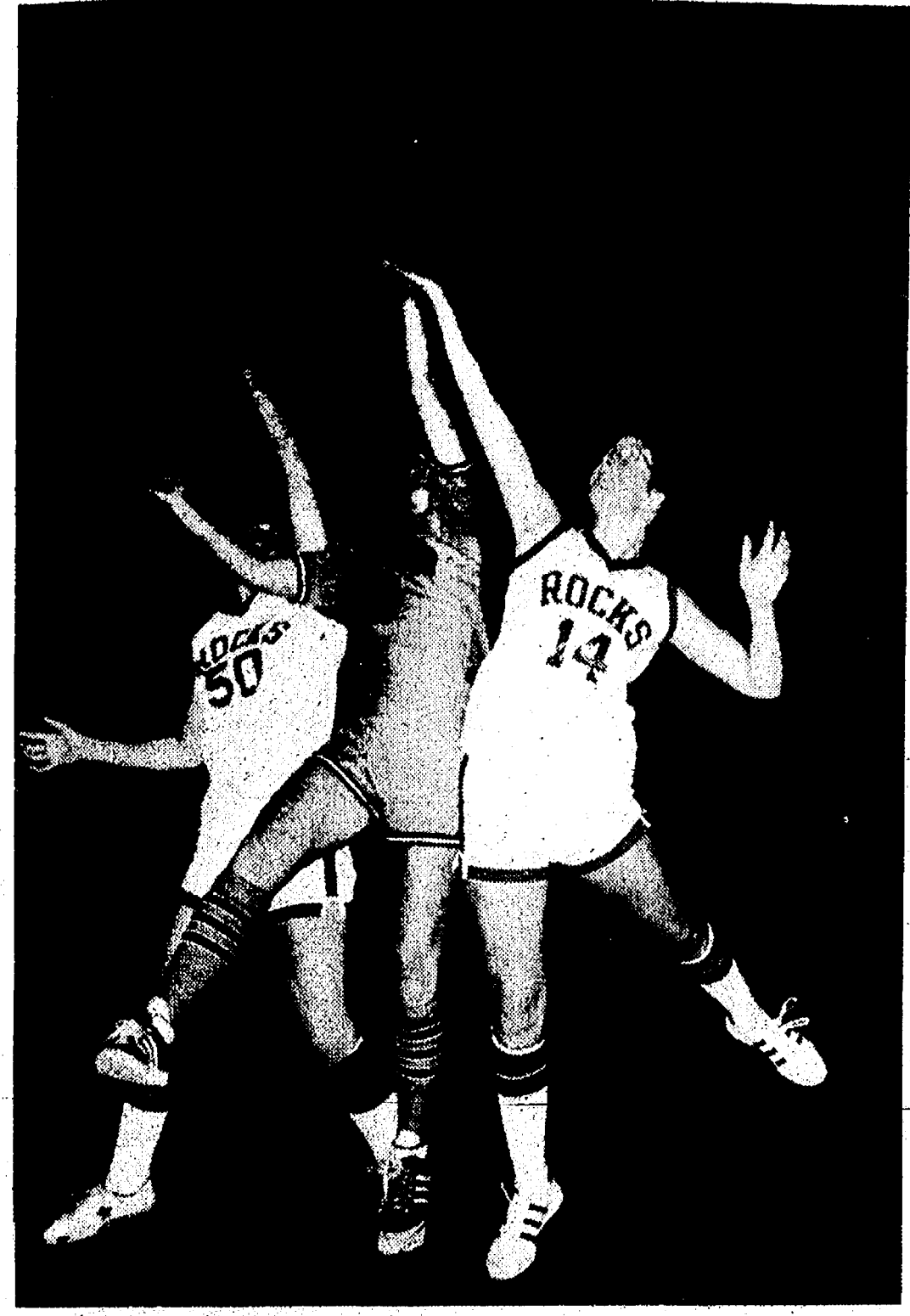

ROCKS' DORIS HOELSCHER (50) and Sarah Marks (14) fight for the ball in their conquest of Dearborn Thursday. (Crier photo by Bill Bresler.)

Rocks blast Dearborn

BY CHAS CHILD

Salem's cagers go back on the winning track Thursday by beating Sub-8 opponent Dearborn, 39-32.

It was an especially important victory for the Rocks, because the Pioneers will be in Salem's district in the upcoming state playoffs.

Last Tuesday, the Rocks lost to Garden City East, the third in a string of consecutive losses.

Four starters - Brenda Davis, Doris Hoelscher, Anne Moore and Debbie Pitera - had been benched for the East game by Coach Debbie Hatcher for "non-academic disciplinary reasons."

The Dearborn contest was even into the second quarter, but Debbie Pitera sank three quick field goals to lead the Rocks to a 23-13 halftime score.

Salem outscored the Pioneers 14-7 in the second quarter to open the 10 point bulge.

Kathy Dillon repeated Pitera's six-point effort in the third quarter to keep the Pion-

ers at a safe distance and the Rocks held them off for the 39-32 win.

Dillon led the Rocks with 14 points. She also contributed eight steals and 13 rebounds. Sarah Marks grabbed 11 rebounds in a strong effort that helped the Rocks control the game.

Garden City East beat Salem after time ran out with two free throws, 33-31. The Rocks missed a shot with 20 seconds to go and East got the rebound and brought the ball up the court, the score tied, 31-31.

The Panthers missed three shots but a foul was called on Salem and Debbie Boehlin of East sand two free throws to win the game.

"We played excellent defense but didn't have enough offense," Coach Debbie Hatcher said. "Plus we only committed nine fouls."

Dillon led the Rocks in scoring with 16 points. Mary Dickey added six and Peggy Somers, four.

Volleyball clinics set

Developmental volleyball clinics for players and coaches will be held at Schoolcraft College on Nov. 18-19.

Clinicians for both days are Tom Teeters, coach of Schoolcraft's varsity women's team and Mike O'Toole, the team's former coach.

The clinic runs from 4 until 10:30 p.m. Friday evening, Nov. 18, and it will be repeated between 8:30 a.m. and 4 p.m. the following day, Saturday.

There is a \$6 per person charge for the clinic.

Further information is available from Dr. Cecil Woodruff, acting athletic director, at 591-6400 ext. 403.

Nichols featured

Dr. Harold Nichols, head wrestling coach at Iowa State University, will be the featured clinician at Schoolcraft College's sixth annual wrestling clinic on Nov. 12.

For further information call Dan VanHusan, Schoolcraft wrestling coach, at 426-3981

INSULATED

\$40 & up

You Don't Have To Be A Horse To Shop At...

ELLIOTT'S SADDLERY

455-1800

217 N. MAIN - PLYMOUTH

Salem gridders selected for Sub-8 team

Salem landed six football players on the all-Suburban Eight first team, and three more Rocks made the second team. Co-captain Bob Dasher lead the selections for Salem. He was named to the first team at center on offense and the

second team on defense at the tackle position.

Quarterback Rich Hewlett was a unanimous selection for the first team. The junior signal-caller lead the Rocks to the Sub-8 crown this year.

Linebacker Doug Agnew also made first team for the second year in a row. Safety Curt Lewis and Bruce Piper, a tackle, rounded out Salem's first team defensive contingent.

Tackle Tony Vitale also earned first-team honors.

Besides Dasher, End John Broderick and Defensive Back Mike Genrich made the second team.

Those selected for honorable mention were: Bob Doherty, Kevin Kesckes, Wally Brown, Scott Kappler, Chris Ritchey and Mike Skone.



TONY VITALE

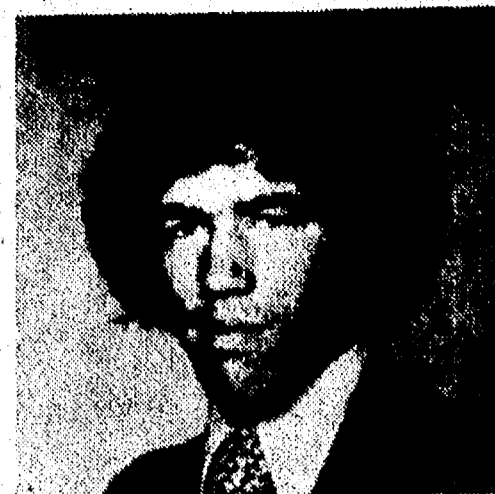

BRUCE PIPER



CURT LEWIS



BOB DASHER



DOUG AGNEW



RICH HEWLETT

McAllisters
Your Complete Beverage Store
On Northville Rd. opposite Plymouth Hilton
7 a.m. - 11 p.m.
455-9363
Beer * Package Liquor (incl. 1/2 gal. & gallons)
* Over 200 types of Domestic & Imported Wines
* Champagnes * Meats
* Keg Beer * Groceries

Firewood
 729-5817
WE DELIVER

Rock JV gridders finish 7-1

The Salem junior varsity football team finished an excellent season Thursday by beating Canton 54-0. The victory gave the Rocks a 7-1 final record.

The team's only loss came at the beginning of the campaign to Allen Park, 16-12. All of the other Suburban Eight JV squads fell to the Rocks.

There are 31 players on the team, all sophomores, and Jarvey said they all did a fine job. "It's hard to single anyone out."

The biggest victory was over Dearborn, who lost to Salem, 61-14. Coach Jim Jarvey said

the Rocks' second team played the whole second half of the Dearborn victory.

Chief JV's winless

Canton's junior varsity football team ended an 0-8 season Thursday with a 54-0 loss to Salem. The highlight of the Chiefs' season was a slim 9-0 loss to Northville. The game was scoreless until the Mustangs' kicker booted a 45-yard field goal. Northville's touchdown came in the final 30 seconds

after intercepting a desperation Canton pass.

"We had some bad breaks during the year," Coach Mike Tiano said. "We lost a lot of players to the varsity and some key players transferred out of the school district."

There were 17 sophomores and two freshmen on the team.

Log Carriers
Wicker Warehouse
689 N. Mill St.
Plymouth/459-2990
Cutting Boards
Natural Wood & Leather Chairs
100's of Assorted Baskets
Towel Racks
Hors D'Oeuvre Cutters
Whiskey Barrel Tables
Plant Holders
Wicker Cabinets
Wicker Tables
"Find a gift for the person who has everything"

GIVE THE FAMILY A GRANDFATHER FOR THE HOLIDAYS

ALL GRANDFATHER CLOCKS
15% to 25% OFF DELIVERED BEFORE THANKSGIVING DAY
INCLUDES DELIVERY-SET-UP — 2-YEAR WARRANTY
Northville Watch & Clock Shop
We specialize in the sale and repair of antique watches & clocks.
132 WEST DUNLAP NORTHVILLE 349-4938
(One block north of Main Street) HOURS: Mon-Sat 9-6, Sunday 12:30-5:00

Sports happenings

GIRLS BASKETBALL		
Thurs., Nov. 10	Canton vs. Harrison (Vars. only)	T 7 p.m.
	Salem vs. Belleville	T 6:30 p.m.
Tues., Nov. 15	Salem vs. N. Farm. (Vars. only)	T 7 p.m.
GIRLS SWIMMING		
Thurs., Nov. 10	Canton vs. Harrison	T 7 p.m.
	Salem vs. Belleville	T 7 p.m.

EVENING MEDICAL CARE, P.C.
After hours medical care for the treatment of illness, injuries, and minor emergencies.
OPEN 7 DAYS A WEEK
Mon-Sat 5-10 p.m.
Sundays & Holidays Noon 5 p.m.
CANTON PROFESSIONAL PARK
8552 N. Canton Center Rd.
Canton Township, MI. 48187
455-4040

Lions fete Jones

Ward Jones, first president of the Plymouth Lions Club, was recognized for his 45 years of continuous service in the International Association of Lions Clubs by fellow members of the Plymouth club at their last regular meeting. Fellow Lion Bruce Richard presented him with his 45 year chevron.

Jones, who was among the organizers of the Plymouth Club in 1948, had previously served as president of the Detroit Uptown Lions Club.



Rezoning sought for Road House

PLYMOUTH TOWNSHIP PLANNING commissioners will consider a pair of rezoning requests Nov. 16 that would permit improvement and expansion of the Ann Arbor Road House restaurant on Ann Arbor Road east of Ann Arbor Trail. The facility is currently a non-conforming use of property zoned residential. Road House owner Adam Stoja

is scheduled to ask the planning commission to approve rezoning of a portion of the Road House property to C-2 commercial. He plans to remodel both the interior and exterior of the facility. Shown is a rendering by the architectural firm of Graham-Culotta of the proposed exterior changes.

Twp. reacts to annexation threat

Cont. from pg. 1

1974 on the eve of the defeat of a vote to consolidate the city and township, that call for the annexation of the township as a whole and of the property on which the Hillside Inn is located.

According to Breen, if the boundary commission acts within 220 days (seven months) to approve the city's annexation of the entire township a vote of township residents would be required.

If township voters rejected the annexation proposal, Breen said, the incorporation petition would likely become active and township voters would be asked on a referendum ballot to create of the City of Plymouth Heights.

James Hyde, executive secretary of the boundary commission, told The Crier yesterday he had not been notified that the incorporation petitions were on their way, although he said, "I have heard rumors to the effect that they might be doing it."

The township had challenged the constitutional authority of the boundary commission to grant the city's annexation request, but in response to other petitioners in similar cases, the Supreme Court has now declared, "The legislature is free to change city, village, or township boundaries at will." In areas with populations of 100 or more, however, residents are permitted to decide their annexation by ballot.

Asked if the court's ruling might encourage township officials to take a new look at consolidation with the city, one trustee said, "There's some impetus for us to do so. Everybody has to take a hard look at where we're going."

Car dealer asks Twp. for rezoning

Bob Jeanotte Pontiac, is expected Nov. 16 to ask the Plymouth Township Planning Commission for rezoning from residential to commercial of a parcel on the north side of Ann Arbor Road east of Haggerty.

The Jeanotte dealership is currently located on Ann Arbor Road west of Main in the City of Plymouth.

The township is currently fighting in court a rezoning attempt on property adjacent to nearly four-acre parcel slated for consideration next week.

Community deaths

Byrne

Richard J. Byrne, 59, of Burroughs St., Plymouth, died Nov. 6 in Detroit. Funeral services were held in Our Lady of Good Counsel Catholic Church with The Rev. Fr. Kenneth MacKinnon officiating. Burial was in all Saints Cemetery, Des Plaines, Ill. Local arrangements were by Schrader Funeral Home.

Mr. Byrne is survived by his wife, June; a son, Jack of Belleville; and a sister, Mrs. Eileen Van Vooren of California.

He was a long-time resident and attorney for Ford Motor Co., as well as a member of Our Lady of Good Counsel Catholic Church.

Frederick

Olive V. Frederick, 83, of 814 Fairground St., in Plymouth died Oct. 31 at her home in Plymouth. Funeral services were held at Schrader Funeral Home in Plymouth with the Rev. Samuel F. Stout officiating. Burial was in Riverside Cemetery.

She is survived by a daughter, Mrs. June Hesse, Sr. of Plymouth; sister, Mrs. Elva Kohler of Plymouth; grandson, Ronald Hess, Jr. of Plymouth and three great grandchildren.

She was born and lived in Plymouth most of her life.

She was a packer in a manufacturing corporation.

Paulun

Hattie Paulun, 78, of 616 Forest, Plymouth died Nov. 3 at Wayne County General Hospital, Wayne. Funeral services were held at Schrader Funeral Home with The Elder Lawrence Leeson officiating. Burial was in Riverside Cemetery.

Mrs. Paulun is survived by her husband, Karl Paulun, daughter, Dr. Margaret Ann Kinsel of Ironwood; sons, Irwin K. Paulun of Southgate; Melvin O. of Canton; James A. of St. Clair Shores; 17 grandchildren and two great grandchildren.

She was an elevator operator in the service industry.

Hannel

Amelia Marion Hannel, 79, of 42512 Ashley Court, Canton, died Nov. 1 at St. Mary Hospital in Livonia. Funeral services were held by Lambert Funeral Home in Plymouth with the Rev. Frank B. Smith officiating. Burial was in Cadillac Memorial Gardens.

Mrs. Hannel is survived by her husband Frederick C. Hannel, daughter, Mrs. Evelyn Wassman; nine grandchildren and one great grandchild.

She was a housewife.



Fred Schrader's horse drawn hearse, Circa 1904.

The **SCHRADER** family
FUNERAL DIRECTORS IN PLYMOUTH
SINCE 1904

A Tradition Dedicated to Service

For three generations the Schrader family has strived daily to provide the highest degree of thoughtful, considerate and personal service.

280 SOUTH MAIN STREET
PLYMOUTH 453-3333

DO PEOPLE REALLY PREFER TO BE ALONE IN THEIR GRIEF?

No! Being alone makes the pain harder to bear. That's why you should go to the funeral of relatives and friends and make a condolence or sympathy visit, too.

John F. Locniskar, D.I.C.
William G. Lambert
Jim Vermeulen

Lambert
FUNERAL HOME

46401 Ann Arbor Road
(1 mile west of Sheldon Rd.)
Plymouth, Michigan 48170
459-2250

\$2⁵⁰ for 10 Words
10¢ for each additional Word

Crier Classifieds

DEADLINE 5 p.m. MONDAY

CALL
453-6900

HELP WANTED

Delivery person needed, apply in person at Heide's Flowers & Gifts, Inc. Ann Arbor Trail & Harvey btwn. hours 9-6 p.m., Mon thru Fri...

HELP WANTED

Run out of money before you run out of month? Turn the tables with extra income. The AMWAY way. Get the whole story. phone 455-9132.

HELP WANTED

AVON
NOW IS A GOOD TIME TO MAKE EXTRA MONEY. It's the time of year when you need extra money for 1001 things. It's also an ideal time to become an Avon Representative. Business is good and you choose your own hours. Call 291-7862 today.

HELP WANTED

IMMEDIATE OPENINGS for R.N. and L.P.N. Apply in person West Trail Nursing Home, 395 West Ann Arbor Trail;

IMMEDIATE OPENINGS for cook. Apply in person West Trail Nursing Home, 395 West Ann Arbor, Trail.

HELP WANTED

Neat homemaker, you can earn extra income helping others to a better life. Part time or full time. Phone 459-9120.

HELP WANTED - CONCESSION OPERATOR, apply at Plymouth Cultural Center, 525 Farmer.

ARTICLES FOR SALE

HIDDEN TREASURES

Thrift Shop has lovely furniture, household items, wall decorations, draperies, bedspreads & much more from fine homes in the area. You'll be delighted at the low-low prices. Located at 849 Penniman across from Plymouth Post Office. Closed Wednesdays, 459-9222.

RUMMAGE SALE DON'T MISS THESE GREAT BARGAINS!
Nov. 11, 8:30 - 4:30 pm.
ST. JOHN'S EPISCOPAL CH.
574 S. Sheldon, Plymouth

Two Living Room Chairs
Flexsteel green crushed velvet, like new, G.A.E. automatic dual 8 Movie Projector, 459-6964.

2 Snow Tires mounted on GM wheels, balanced - J78-15, 6 ply bias belted, low mileage. \$50 pair, 453-4586.

Two Snowtires & wheels, Size "G" 78-14, polyester, slightly used \$50. Call 453-7879.

Firewood, well seasoned. Oak \$35 per cord. 455-1410.

VEHICLES FOR SALE

1974 Red 2 door Dodge Monaco - Bids accepted at Plymouth Community Federal Credit Union, 500 S. Harvey, 453-2222.

TOWNE GOURMET FOODS
Order Your
FARM FRESH TURKEY-89¢ lb.

833 Penniman
Plymouth
455-2749

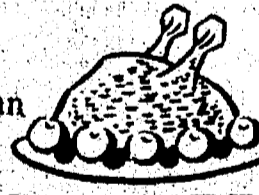

NOTICE TO BIDDERS
CITY OF PLYMOUTH, MICHIGAN
Notice is hereby given that the City of Plymouth, Michigan, will receive sealed bids up to 2:00 p.m., E.S.T., Wednesday, November 16, 1977, for:
FENCING FOR FIREHOUSE NO. 2 PLAYGROUND
Specifications are available at the office of the City Clerk during regular office hours.
The City Commission reserves the right to accept or reject any or all bids, in whole or in part, and to waive any irregularities. Address bids to:
Paul V. Brumfield
City Clerk
201 S. Main Street
Plymouth, Michigan 48170
in a sealed envelope bearing the inscription "BID FOR PLAYGROUND FENCING".
PAUL V. BRUMFIELD
CITY CLERK



GARLING 199 N. MAIN PLYMOUTH

COMMERCIAL VACANT
City of Plymouth on 170 x 495 lot in Plymouth Twp., just one mile to new expressway. Terms available. \$14,000.00
Main Street. 2 story older home in good condition, basement, 2 car garage, black top parking. \$60,000.00

R REALTOR 453-4800

ANNOUNCEMENT OF INTENT TO PERFORM FLOOD ELEVATION STUDY
The Federal Insurance Administration (FIA) of the U. S. Department of Housing and Urban Development announced today that under authority of the National Flood Insurance Act of 1968 (P. L. 90-448), as amended, and the Flood Disaster Protection Act of 1973 (P. L. 93-234), it will fund a detailed study of the flood hazard areas in the Charter Township of Canton.
The study will be performed for the Federal Insurance Administration by Wade, Trim & Associates, Consulting Engineers.
The purpose of this study is to examine and evaluate the flood hazard areas in the community which are developed or which are likely to be developed and to determine flood elevations for those areas. Flood elevations will be used by the community to carry out the flood plain management objectives of the National Flood Insurance Program. They will also be used as the basis for determining the appropriate flood insurance premium rates applicable for new buildings and their contents, as well as determining the rates to be used for the second layer of insurance on existing buildings and contents.
This announcement is intended to notify all interested persons of the commencement of this study so that they may have an opportunity to bring any relevant facts and technical data concerning local flood hazards to the attention of the FIA for consideration in the course of this study. Such information should be furnished to Supervisor Harold P. Stein, the Chief Executive Officer of the community, for forwarding to FIA.

ADVERTISEMENT FOR BIDS
Plymouth-Canton Community Schools, Board of Education Offices, 454 S. Harvey Street, Plymouth, Michigan 48170, will receive separate sealed bids for the construction of each of the Projects listed below on November 29, 1977 at 1:00 p.m., E.S.T. at the offices of the Board of Education, located at the above referenced address, at which time and place all bids will be publicly opened and read aloud.
Projects:
1. New Storage Addition to Smith Elementary School.
2. New Storage Addition to Starkweather Elementary School.
3. Installation of New Lighting at Existing Centennial Park Tennis Courts plus New Adjacent Parking Lot.
4. New Field Storage-Maintenance-Toilets Free Standing Structure adjacent to existing football field at Canton High School (Building A).
For Each Project Separate Proposals will be received as follows:
Form of Proposal - Architectural Trades, Mechanical Trades, Electrical Trades.
Proposals must be on form furnished by Architect and accompanied by a Bid Bond in the amount of five percent (5%) of the proposal submitted.
Plans and Specifications may be obtained at the office of the Architect, Graham-Culotta Architects AIA, 491 S. Main Street, Plymouth, Michigan, on November 10, 1977.
A check in the amount of \$20.00 must be submitted as a deposit for each set of Plans and Specifications for each Project or a maximum of \$80.00 for all Projects, same to be refunded upon return of Documents.
Accepted Bidders will be required to furnish satisfactory Performance Bond and Labor and Material Bond, each in the amount of 100% of the Contract, the total cost of which shall be paid by the accepted bidder.
All proposals submitted shall remain firm for a period of thirty (30) days after the official opening of bids.
The Board of Education reserves the right to reject any or all bids, in whole or in part, and to waive any informalities therein.
PLYMOUTH-CANTON COMMUNITY SCHOOLS
PLYMOUTH, MICHIGAN
Flossie Tonda
Secretary
Board of Education
PLYMOUTH-CANTON COMMUNITY SCHOOLS

Household services

Plymouth Janitorial Service
Professional OFFICE CLEANING
Hours at your convenience-References. Let our staff handle what you can't-don't have time to do.
"Our business is to please YOUR customers"
453-8297

H.F. STEVENS
Asphalt Paving
Residential Work, Repairs,
Seal Coating
453-2965
Licensed and Insured

DAVE'S CARPET CLEANING
CARPET SALES AND SERVICE
ALSO FURNITURE CLEANING
459-3090

CUSTOM CARPENTRY
BASEMENTS FINISHED
CABINETS FORMICA TOP
REMODELING WOOD BEAMS
Dale Martin
453-1760

Aluminum Siding and Trim,
Storm Doors and Windows,
Roof, Additions, Free Estimates.
Bill McNamara, licensed builder,
459-2186.

FIND WHAT YOUR LOOKING FOR
CRIER CLASSIFIEDS

PAINTING
INTERIOR AND EXTERIOR
CEILING AND WALL REPAIR
FREE ESTIMATES
Phone 721-5008 days and weekends or 729-8547 after 5 p.m. and weekends.
No job too small
Phone Now and Save

CALL
453-6900

PLYMOUTH-CANTON
Showcase of Homes
REAL ESTATE BROKERS-
SALES PERSONNEL
CALL 453-6900 FOR DETAILS

Plymouth-all brick ranch. Excellent condition in good area. Features 3 bedrooms, livingroom, kitchen, full basement with new furnace, newer roof and 2 1/2 car garage. Reduced to \$47,500. IMMEDIATE OCCUPANCY.
453-7800
906 S. Main - Plymouth
Wm. Fehlig Real Estate
453-7800
906 S. Main Plymouth

\$2⁵⁰ for 10 Words
10¢ for each
additional Word

Crier Classifieds

CALL
453-6900

PG. 29
THE COMMUNITY CRIER: November 9, 1977

VEHICLES FOR SALE

Grand Torino Braughm '75, all power, air, speed control Am-Fm, excellent condition. Phone 459-9120.

'74 Bronco, 26,000 miles, V-8, auto, Ranger Pkg., good condition, 453-5083 after 6 p.m.

VEHICLES FOR SALE

1975 Ford LTD Station Wagon, excellent condition, low mileage, air, 10 passenger. Must Sell. 455-1884.

1969 Ambassador Station Wagon, p.s., air, \$300, 455-9553.

DEADLINE 5 p.m. MONDAY

VEHICLES FOR SALE

Pick up camper, 8 ft cab over, sleeps 4, heater, stove, sink, ice box, 12 volt and 110 volt wired. 455-4013.

1971 Chevy Impalla, all power, air, vinyl top, \$750, 455-9553.

STATISTICAL TYPING

Addressing, Resumes, manuscripts. ROSS Secretarial 459-5151.

WANTED TO RENT

Wanted to rent: 2-car garage or suitable building for storage in Plymouth area. Call Gerish Building Co., 453-2612.

CLASSES

Enroll now at STORYBOOK GARDENS NURSERY SCHOOL, 42290 Five Mile Rd., Plymouth. For information call 453-1572.

CONDOS FOR SALE

Exceptionally clean, well decorated two bedroom Canton Condo. Appliances, up graded carpeting, well landscaped, low maintenance fee, many extras. Asking \$24,500 by owner, 455-5442.

MISCELLANEOUS

Tri City paper book xchange. Michigan Ave. at Beck, Canton -- every afternoon except Monday. Your book and 29 cents buys another.

PETS

Fluffy tiger and calico kittens looking for love and attention. 453-5087.

LOST & FOUND

Found an orange striped, long hair, male cat with white flea collar, 455-1895.

MUSICAL INST. FOR SALE

Music Man Bass Amp. Hd 130, 2 Channel top, Reflex Bottom with 15" speaker. KE8-3144 or 534-0917.

CURIOSITIES

Complete stock of simplicity and Butterick Patterns half off. Formerly Sue Ann Fabrics.

Bob and Joanne are growing older at the same time-Happy Birthday from the staff.

\$5 Gift certificate if your idea is used to rename our shop-Formerly Sue Ann Fabrics (Panniman Avenue Shops.)

Bed'n Stead is selling Christmas finger tip towels at \$2.00 and \$1.25. They make great gifts! 455-7380.

Bring this ad to Bed'n Stead. We'll give you 15% off on our new paper napkins -- get stocked for the holidays! 455-7380.

Marsha: Is it baby yet?

Meatball: Thanx for the two-skin. Glad it wasn't double.

This week's quiz: Who won the city commission election? Answer on page one... maybe.

To Diane: Happy Housewarming Tauma too. Paul.

A great season, ROCKS!!! Good luck at state!!! Your faithful fans -- the Smiths.

In Plymouth happiness is seeing the caboose.

CONGRATULATIONS Linda Enochs. You are this weeks \$10 gift certificate winner at Young Sophisticats.

Delicious, delightful, definitely the greatest cooking class in town -- just ask the Midnite Munchies Graduates, Class Nov. 5, 1977.

Thanks to Matt, our long-distance sports writer.



Real Estate

BY WILLIAM DECKER

REALTOR

ON SECOND MORTGAGES

When mortgage money is plentiful, lower down payments are common and lending institutions are looking for borrowers for mortgage money.

However, the picture changes when money is tight. Often, higher down payments are required. If you do not have the cash to meet the full down payment, second mortgages are also available and nothing to be afraid of. The seller or some other lender may agree to loan you the balance of the down payment in this manner.

The second mortgage on the property carries a higher interest rate and a shorter repayment time -- usually from three to five years.

The reason for this is the higher risk involved because the second mortgage cannot be satisfied in case of default until after the first mortgage is paid off.

The second mortgage can be an excellent way to complete the sale of property which would otherwise fall by the wayside. Listen very closely to your REALTOR in this situation because professional expertise is a MUST.

If there is anything we can do to help you in the field of real estate, please phone or drop in at REALTY WORLD, Wm. Decker, Inc. Realtors, 670 S. Main St. Plymouth. Phone: 455-8400. We're here to help!

ELEVEN SCHOOL BUSES FOR SALE BID NO. 1007

The Board of Education of Plymouth - Canton Community Schools invites the submission of sealed bids on the following listed sixty passenger school buses. All sales are final and as is, where is. The buses can be seen daily between 9:00 a.m. and 4:00 p.m. at 1200 S. Mill Street, Plymouth, Michigan. To inspect the buses, please contact Mr. Robert Houghton or Mr. Cal Heard at the above location.

Seven (7) 1969 Chevrolet 60 passenger buses. Numbers: 18A, 19A, 20A, 21A, 22A, 23A, 24A

Two (2) 1968 Ford 60 passenger buses. Numbers: 14A and 15A

Two (2) 1966 Ford 60 passenger buses with seats removed. Numbers: T4 & T8

Bids will be received until 10:00 a.m. on the 11th day of November, 1977 at the Purchasing Department, located at the Board of Education Building, 454 S. Harvey Street, Plymouth, Michigan 48170 at which time and place all bids will be publicly opened and read. The right to accept or reject any and/or all bids is reserved. Any bid submitted will be binding for thirty days subsequent to the date of bid opening. Upon notification, the successful bidder shall submit payment in the form of cash, money order, cashiers or certified check, made out to: Plymouth-Canton Community Schools within five business days of notification and have fourteen (14) calendar days following submission of payment to remove vehicle(s) from school property.

CHARTER TOWNSHIP OF CANTON

NOTICE IS HEREBY GIVEN that \$875.00 cash was found at 40139 Michigan Avenue, Canton, Michigan on September 2, 1977. Any person claiming ownership to said money, may do so at 44508 Geddes Road, during regular office hours.

JOHN W. FLODIN
CLERK

NOTICE TO BIDDERS

Plymouth-Canton Community Schools is seeking bids for miscellaneous partial roof replacement projects bid No. 1007 at the following schools: West Middle School install total gym roof -- mar-foam dry-roof tapered roof insulation system with 4 ply glas-felt 20 year bond roof. Central Middle School remove partial roof, install insulation and place 4 ply glas-felt 20 year bond roof. Bird Elementary School remove partial roof and place 4 ply glas-felt 20 year bond roof. Bids will be received until 10:00 a.m. on the 23rd day of November, 1977, at Board of Education Building, 454 South Harvey Street, Plymouth, MI. at which time and place all bids will be publicly opened and read. Specifications and bid form may be obtained at the purchasing office. The right to reject any and/or all bids is reserved. Any bid submitted will be binding for thirty days subsequent to the date of bid opening.

BOARD OF EDUCATION
PLYMOUTH CANTON COMMUNITY SCHOOLS
Flossie Tonda
Secretary

'77 CLEARANCE SALE! SPECIAL THIS WEEK



FORD F 100 STYLE SIDE

Ranger XLT Pkg., 300 Engine, P.S., Radio, Extra Fuel Tank, Step Bumper. No. T7 2341.

\$4175

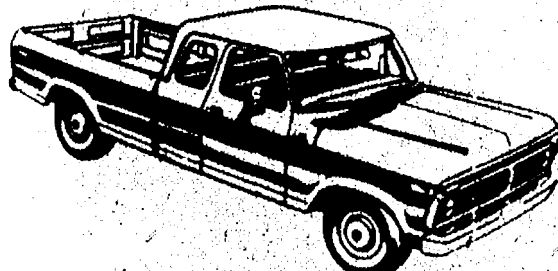

FORD F 150 SUPER CAB

351 V8, P.S., Air, T.G., Radio, Extra Fuel Tank, Rear Step Bumper. T7 2340.

\$5149

FORD F 100 SUPER CAB

Cinnamon Glow, Ranger XLT Pkg., 460 Engine, Auto., P.S., Air, T.G., C.T.R. Facing Seats, AM-FM Multi-Plex Radio, Aux. Fuel Tanks and many other useful options. No. T7 1782.

\$6248

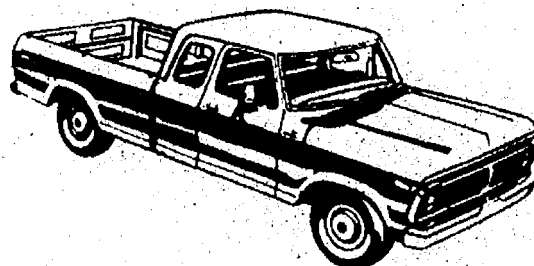

FORD RANCHERO

Dk. Brown Met., 400 Engine, Auto., Radio, Dual Racing Mirrors, P.S., PB., No. T7 2168.

\$4187



JACK DEMMER

37300 MICHIGAN AVE.,
WAYNE
721-2600



NEED A NEW

CREDIT START?

HUNDREDS

OF

USED CARS

AND

TRUCKS

TO CHOOSE FROM

CALL CEE or
KARR AT:

North Bros. Ford
421-1300

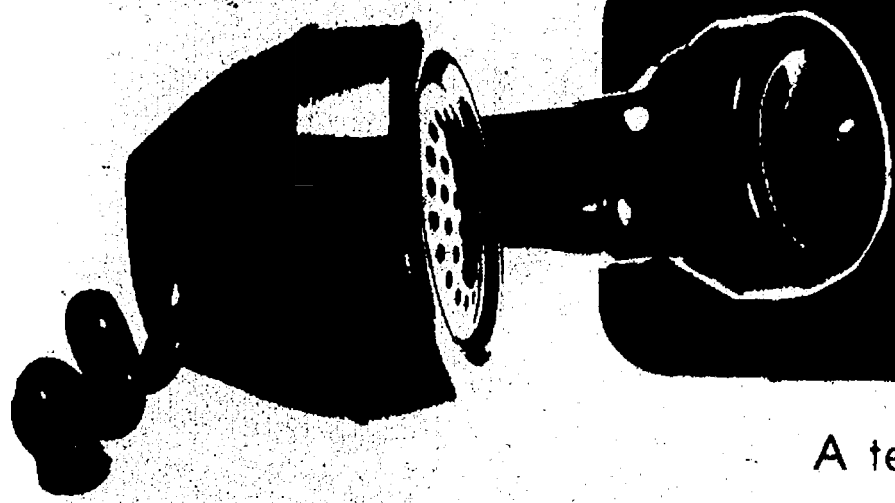

Dial-It-Shopping

A telephone directory of services in the Plymouth-Canton Community

Apparel-Ladies

NEW GAL IN TOWN
In Old Village
620 Starkweather
Plymouth
453-5575

Come in and browse - a classic look in styling - fashions that are always in style.

Automotive Repair

DENNY'S SERVICE
1008 Starkweather
Plymouth
453-8115

*Front-end work * Tune-ups
*General repair * Certified Master-Mechanics * 24 hr. towing.

Bakery

MARIAS ITALIAN BAKERY
115 Haggerty - 981-1200
38411 Joy Rd. - 455-0780
*Square Pizza *Hot Italian Bread * Sausage * Baked Goods * Cannoles * Cakes * Italian Lunch Meat * Beer * Wine

Beauty Salon

GERALDS' OF NORTHVILLE
41012 Five Mile
Plymouth
459-9800

'HAIRDRESSERS WHO CARE'

Book Store

PLYMOUTH BOOK WORLD
2 Forest
Plymouth
455-8787

Please don't forget to inquire about our book registry, aid for giving books as gifts.

Candies

KEMNITZ FINE CANDIES AND GIFTS
896 W. Ann Arbor Tr.
Plymouth
453-0480

On your way to Grandma's for Thanksgiving dinner, don't forget Kemnitz's homemade chocolates for the perfect hostess gift.

Carry-Out Restaurant

BEE-JAY'S KITCHENS
628 S. Main
Plymouth
455-8010

Pick-up or Delivery.
Pizza * Ribs * Seafood * Spaghetti * Fast Service.

Cheese & Wine

CHEESE & WINE BARN
515 Forest Ave.
Plymouth
453-1700

Lunch suggestions-Hot spinach and meat pies, sandwiches, baklava, and fresh ground coffee. Gift baskets-All Occasions.

Chicken Take-Out

GRANDMA'S TAKE-HOME CHICKEN
1122 W. Ann Arbor Rd.
Plymouth
453-6787

Dinners * Buckets * Barrels
*Thurs. special - 3 piece dinner \$1.49, regularly \$1.97
Proprietor - Joe Langkabel.

Cleaners

ONE HOUR MARTINIZING
44469 W. Ann Arbor Rd.
Plymouth
455-9170
"Fresh as a flower in just one hour." Draperies - furs - expert tailoring and alterations.

Crafts

BUSY BEE CRAFTS
1082 S. Main
Plymouth
455-8560
Specializing in macrame - needle-pointe - crewel - latch hook - jewelry. Supplies & classes - also custom made gifts.

Dairy & Ice Cream

CLOVERDALE FARMS DAIRY
447 Forest
Plymouth
455-4933
Retail - wholesale milk - Ice Cream - Ice Cream Cones, sundaes, restaurant, convenience foods. Drive up service.

Dance Instruction

MASTER OF DANCE ARTS
6034 Sheldon Rd.
Harvard Square Center
455-0720
Ballet & toe * Tap * Jazz * Preschool * Hawaiian * Gymnastics * Baton * Disco * Ballroom. Fall enrollment now being taken.

Dolls- Old & New

LORRAINES DOLLS HOSPITAL & TOYS
615 N. Mill
Corner of Spring St.
459-3410 - 464-2010
Effanbee, German and Italian dolls. Doll and doll house kits. Miniatures * Wicker bugles * Wooden toys.

Electrician

SAMSONOW ELECTRIC
455-1166
Complete electrical service. Commercial - residential - industrial. Electric heating, electrical code violations corrected.

Fireplace & Barbeque

DECK & DEN SHOPPE
44700 Ford Rd. at Sheldon
In K-Mart Shopping Plaza
455-7080
Custom fireplace equipment, glass doors, gas logs, tool sets, patio furniture, gas grills, wall decor.

Floor Covering

BLUNK'S
640 Starkweather
Plymouth
453-6300
Carpets by - Lees - Bigelow - Barwick - Armstrong and Cranbrook. Tile & Linoleum by - Armstrong Solarian - Kentile and Amtico.

Florist-Dried Flowers

THE STATICE SHOP
838 Penniman
Plymouth
455-0678
Visit Williamsburg in Plymouth for permanent Christmas greens, fruits and garlands. Place your Christmas orders now.

Furniture

LAUREL FURNITURE
Complete home furnishings. Large selection of baby furniture clocks. Quality furniture moderately priced. Free delivery.
584 W. Ann Arbor Tr.
Plymouth
453-4700

Furniture Refinishing

FURNITURE REJUVENATION UNLIMITED
882 Holbrook
Old Village - Plymouth
459-4930
Natural and painted wood finishes, single pieces thru bedroom and dining room sets.

Furniture Stripping

THE VILLAGE STRIPPER
140 E. Liberty
Plymouth
455-3141
Finishes removed from wood - metal - wicker. 10 - 6 Tues. thru Fri. 10 - 3 Sat. Refinishing available.

Garage Builders

BARNES BROS. GARAGE & MODERNIZATION
9255 Canton Center Rd.
Plymouth
453-9102
"This areas own home garage specialist" Home additions, siding, free planning & estimates. Terms available.

General Contractors

SHIELD CONSTRUCTION
711 W. Ann Arbor Tr.
Plymouth
455-6350
Custom homes * Remodeling and additions * Family rooms * Kitchens * Bathrooms * Commercial * Industrial * Residential. Licensed * Bonded * Insured.

Grooming & Board

TOWNE & COUNTRY KENNELS
47857 Cherry Hill Rd.
Canton
453-2790
*All breed grooming & boarding *Reasonable rates * Appointment please * Obedience training * AKC Border Terriers

Guns & Accessories

POWDER KEG GUN SHOP.
186 S. Main
Plymouth
459-1166
Modern, antique, replica rifles, shotguns & handguns. Accessories, ammo, scopes, Indian Jewelry

Hardware Store

S & W PRO HARDWARE
875 Ann Arbor Rd.
Plymouth
453-1290
Complete plumbing & electrical supplies. Builders hardware. Paint, lawn, garden supplies. Do it yourself headquarters.

Health Foods

THE HEALTH SHOPPE
825 Penniman
Plymouth
455-1440
Special Ordering on bulk food products PLUS a discount. Vitamins * Foods * Dietary supplements * Books.

Heating

KRAUSE'S HOME HEATING
453-0228
Featuring Heil Heating & Cooling Equipment. *Dependable service * Free estimates * Custom duct work * Furnace cleaning. *

Insulation

AIR-TITE INSULATION
882 N. Holbrook
Plymouth
453-0250
Save on the cost of heating - cooling. Fast, professional installation - "your comfort is our business."

Insurance

FIRST STATE INSURANCE
496 W. Ann Arbor Trail
Plymouth
459-3434
BUSINESS & PROFESSIONAL INSURANCE
A Michigan full-service insurance agency representing all major companies.

Jewelers

BEITNER JEWELRY
904 W. Ann Arbor Tr.
Across from Mayflower Hotel
453-2715
Well known for our fine jewelry, watches, diamonds, pewter, and silver. Our Service is Superb.

Linens & Gifts

BED 'N STEAD
6 Forest Place
Plymouth
455-7494 - 455-7380
Featuring linens for your beds, tables and bath, also candles, scandinavian imports and hand-crafted gifts.

Liquor-Beer-Wine

CAP N CORK
40644 5 Mile
Plymouth
455-7676
Beer - Wine - Liquor - Keg Beer Complete line of party supplies, special attention for wedding parties.

Locksmith & Saw

PASSAGE LOCK & SAW SHOP
181 Rose
Plymouth
453-7454
Dead Bolts, Electric Tools repaired, Saw & Sissor Sharpening. Over 12,000 key blanks in stock.

Musical Instruction

ARNOLDT WILLIAMS MUSIC
5701 N. Canton Center Rd.
Canton
453-6586
Highly qualified teachers for piano * organ * guitar * voice drums * trumpet * Sax and clarinet.

Picture Framing

OLD VILLAGE GALLERY
383 Starkweather
Plymouth
459-4170
Specializing in Custom Picture Framing and Original gifts of Art - Paintings, Pottery, Prints, Jewelry, Macrame.

Pizzeria

LITTLE CAESARS
42440 Ford Rd
Canton
453-9300
Get one medium Free for price of one with a coupon from the T.V. Guide.

Plumbing

JOHN J. CUMMING PLUMBING
1425 Goldsmith
Plymouth
453-4622
Kohler plumbing fixtures. Residential * Commercial * Repairs *Modernization * Rheem water heaters.

Prof. Photo Finishing

ROBERT K. BRANDMAN
8701 - 27 Belleville Rd.
Belleville
697-6421
3-day service on most orders. Pick-up and delivery. Retouching and air brush work.

Real Estate

REALTY WORLD
Wm. Decker, Inc., Realtors
670 S. Main
Plymouth
455-8400
Your good will is our greatest asset, we are therefore PLEDGED to your service.

Service Center-Auto

TED & EARL'S SERVICE
285 Dunn
Plymouth
453-1600
New Location * Oil change * Lube job * Front ends * Air conditioning * Transmissions * Brakes.

Shades

OLDE VILLAGE UPHOLSTERY
384 Starkweather
Plymouth
455-2500
Woven wood decorative shades. Clear view sun reflecting shades. Custom upholstery. Bar stools. Upholstery supplies.

Travel Agency

PLYMOUTH TRAVEL
479 S. Main
Lorenz - Mayflower Square
455-6600
*Airline tickets * Cruises * Commercial * Groups * Charters * Reserve now for holiday travel, many flights already filled.

Wallpaper & Paint

UNITED PAINT DECORATING CENTER - FACTORY OUTLET
44610 Ford Road
Canton
455-0250
Paints * Wallpaper * Olympic stains * Painting accessories * Min Wax * Water Lox.

Window Treatment

INTERIOR REFLECTION
5948 Sheldon
Harvard Sq. Shopping Center
Canton
459-0100
Window treatments * Wall-coverings * Accessories * Advice - a great background for your interior environment. Shop at home.

WE SELL PUCH

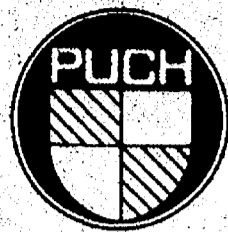

**THE
MAXIMUM
MOPED.**

It's so much fun we almost hate to mention economies like up to 150 miles per gallon of fuel, and practically no maintenance. We've got Puchs in all kinds of nice colors and we'd love to have you take one for a test ride soon.

today there's a new kind of fun called Puch.

The Puch has pedals like a bicycle and a motor like your motor-boat. Which means it can whip you around town in great style without worrying about things like being out of breath, or cardiac arrest.

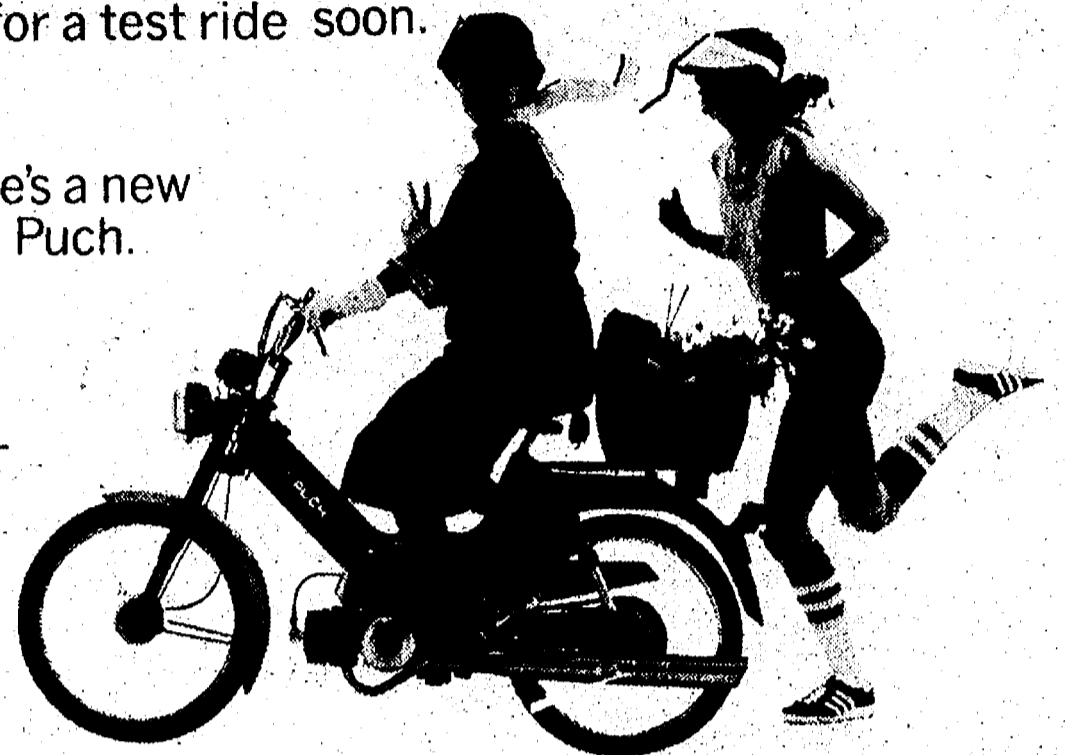

TRADE IN your old bicycle for a liberal TRADE IN allowance regardless of condition

PUCH

The Christmas gift for everyone!

**SCHWINN®
SCHWINN®
SCHWINN®**

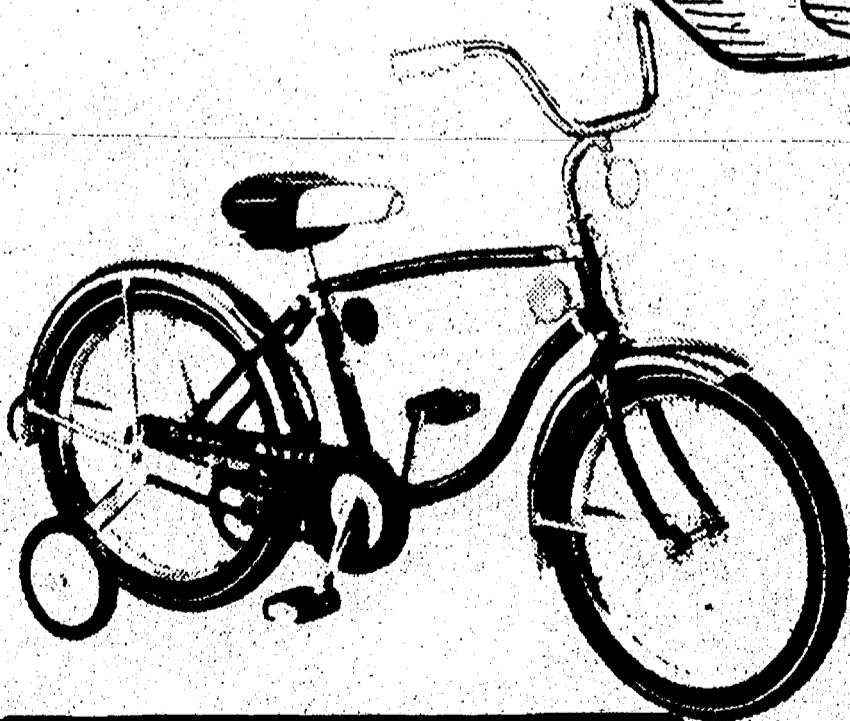

SCHWINN PIXIE

- For riders 3 to 5
- Convertible for boys or girls
- Complete with training wheels
- Chrome fenders, semi-pneumatic tires

\$51⁹⁵

ASSEMBLED AND ADJUSTED AT NO EXTRA CHARGE

**JERRY'S
BICYCLES**

BICYCLES &
WHEEL GOODS
SINCE 1938

1449 W. Ann Arbor Rd.
Plymouth, Mi 48170

459-1500

Built-in speedometer

Built-in audible timer

Built-in resistance control

Easily adjustable seat

SCHWINN DELUXE EXERCISER

- Adjustable tension control
- Built-in timer and speedometer
- "Quick Release" handlebar and saddle

\$146⁹⁵

ASSEMBLED AND ADJUSTED AT NO EXTRA CHARGE

TRADE IN your old bicycle for a liberal TRADE IN allowance regardless of condition

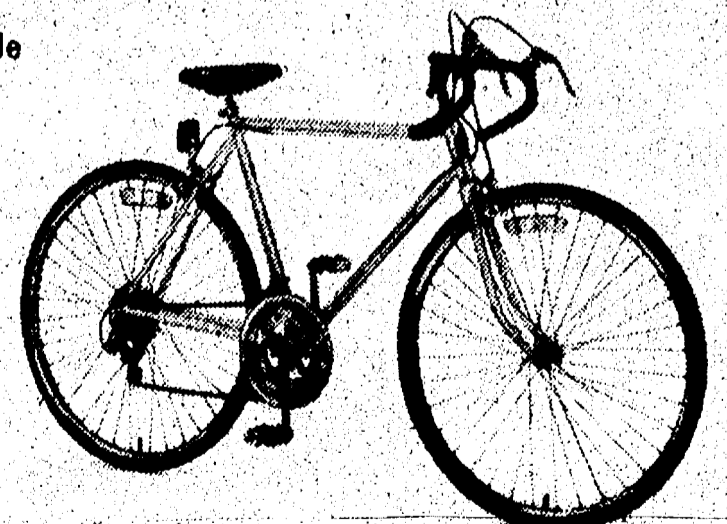

THE SCHWINN SPORTABOUT

- Drop-style handlebars
- 10-speed derailleur gears
- Breeze gumwall tires
- Lightweight styling

\$119³⁵

ASSEMBLED AND ADJUSTED AT NO EXTRA CHARGE